

# INSTALLATION MANUAL

## R-410A 2-STAGE OUTDOOR SPLIT-SYSTEM HEAT PUMP

MODELS: 19 SEER  
YZT, HC19B, HL19B SERIES  
2 – 5 TONS – 1 PHASE



### LIST OF SECTIONS

GENERAL .....	1	SYSTEM CHARGE .....	8
SAFETY .....	1	ELECTRICAL CONNECTIONS .....	11
UNIT INSTALLATION .....	2	INSTRUCTING THE OWNER .....	23
COIL METERING DEVICES .....	6	WIRING DIAGRAM .....	24
EVACUATION .....	7	START UP SHEET .....	25

### LIST OF FIGURES

Typical Installation Clearances .....	3	Communicating HP with Non-Communicating Air Handler or Furnace using Communicating Interface Control .....	13
Alternative Installation Clearances .....	3	Thermostat Chart for Two Stage V/S Furnace – Two Stage Heat Pump .....	14
Insulation of Vapor Line .....	5	Thermostat Chart for Two Stage V/S Furnace – Two Stage Heat Pump .....	15
Underground Installation .....	5	Thermostat Chart for Modulating Furnace – Two Stage Heat Pump .....	16
Heat Protection .....	5	Thermostat Chart for Modulating Furnace – Two Stage Heat Pump .....	17
TXV Installation .....	6	Thermostat Chart for V/S Air Handler – Two Stage Heat Pump .....	18
TXV Bulb and Equalizer Line Installations .....	7	Thermostat Chart for V/S Air Handler – Two Stage Heat Pump .....	19
Proper Bulb Location .....	7	Wiring Diagram .....	24
Vertical Temperature Bulb Orientation .....	7		
Outdoor Unit Control Box .....	11		
Typical 2-Stage Conventional Field Wiring - HP .....	12		
Demand Response Wiring .....	13		
Communicating HP with Communicating Air Handler or Furnace .....	13		

### LIST OF TABLES

Minimum / Maximum Operating Limit Conditions .....	2	YZT24 Heat Charging Chart - CF/CM/CU36 .....	9
Allowable Vertical Linesets .....	2	YZT24 Heat Charging Chart - AE36, AVC36 .....	10
Subcool Adjustment Levels for Downflow and Horizontal-right Installations .....	8	YZT36 Heat Charging Chart - CF/CM/CU36, AE36, AVC36 .....	10
YZT24B21S Subcooling Charging Chart - All Matching Coils .....	8	YZT36 Heat Charging Chart -CF/CM/CU42 .....	10
YZT36B21S Subcooling Charging Chart - All Matching Coils .....	8	YZT36 Heat Charging Chart – CF/CM/CU48, CF/CM/CU60, AE42, AE48, AVC42, AVC48, AVC60 .....	10
YZT48B21S Subcooling Charging Chart - All Matching Coils .....	9	YZT48 Heat Charging Chart - All Matching Coils .....	11
YZT60B21S Subcooling Charging Chart - All Matching Coils .....	9	YZT60 Heat Charging Chart - All Matching Coils .....	11
YZT24 Heat Charging Chart - CF/CM/CU24, AE24, AVC24 .....	9	Status Codes .....	21
YZT24 Heat Charging Chart - CF/CM/CU30, AE30, AVC30 .....	9	Status Code Display & Timing .....	21
		Fault Codes .....	22

## IMPORTANT

*It is recommended before starting the system to connect the thermostat to Wi-Fi using a local network or portable hot-spot so the thermostat and system receive the latest software updates to optimize system performance only if using this in communicating configuration.*

### SECTION I: GENERAL

The outdoor units are designed to be connected to a matching indoor coil with sweat connect lines. Sweat connect units are factory charged with refrigerant for a nominal sized matching indoor coil plus 15 feet of field-supplied lines.

### SECTION II: SAFETY



This is a safety alert symbol. When you see this symbol on labels or in manuals, be alert to the potential for personal injury.

Understand and pay particular attention to the signal words **DANGER**, **WARNING**, or **CAUTION**.

**DANGER** indicates an **imminently** hazardous situation, which, if not avoided, **will result in death or serious injury**.

**WARNING** indicates a **potentially** hazardous situation, which, if not avoided, **could result in death or serious injury**.

**CAUTION** indicates a potentially hazardous situation, which, if not avoided **may result in minor or moderate injury**. It is also used to alert against unsafe practices and hazards involving only property damage.

**⚠ WARNING**

*Improper installation may create a condition where the operation of the product could cause personal injury or property damage. Improper installation, adjustment, alteration, service or maintenance can cause injury or property damage. Refer to this manual for assistance or for additional information, consult a qualified contractor, installer or service agency.*

**⚠ CAUTION**

*This product must be installed in strict compliance with the enclosed installation instructions and any applicable local, state, and national codes including, but not limited to building, electrical, and mechanical codes.*

**⚠ CAUTION**

*R-410A systems operate at higher pressures than R-22 systems. Do not use R-22 service equipment or components on R-410A equipment. Service equipment **Must Be Rated** for R-410A.*

**INSPECTION**

As soon as a unit is received, it should be inspected for possible damage during transit including copper distributor lines that may have shifting during transit, and are touching either copper lines or the cabinet. If damage is evident, the extent of the damage should be noted on the carrier's delivery receipt. A separate request for inspection by the carrier's agent should be made in writing. See Local Distributor for more information.

**Requirements For Installing/Serviceing R-410A Equipment**

- Gauge sets, hoses, refrigerant containers, and recovery system must be designed to handle the POE type oils, and the higher pressures of R-410A.
- Manifold sets should be high side and low side with low side retard.
- All hoses must have a 700 psig service pressure rating.
- Leak detectors should be designed to detect HFC refrigerant.
- Recovery equipment (including refrigerant recovery containers) must be specifically designed to handle R-410A.

**LIMITATIONS**

The unit should be installed in accordance with all national, state and local safety codes and the limitations listed below:

1. Limitations for the indoor unit, coil, and appropriate accessories must also be observed.
2. The outdoor unit must not be installed with any duct work in the air stream. The outdoor fan is the propeller type and is not designed to operate against any additional external static pressure.
3. The maximum and minimum conditions for operation must be observed to ensure a system will give maximum performance with minimal service.

**TABLE 1: Minimum / Maximum Operating Limit Conditions**

AIR TEMPERATURE AT OUTDOOR COIL, °F (°C)		AIR TEMPERATURE AT INDOOR COIL, °F (°C)	
Min.	Max.	Min.	Max.
DB Cool	DB Cool	WB Cool	WB Cool
35(2)*	125(52)*	57(14)	72(22)

4. The maximum allowable equivalent line length for this product is 80 feet.

**Standard Lineset Applications**

Maximum allowable lineset varies depending on the vertical separation between the evaporator and condenser. See Table 2 for allowable line set lengths and sizing.

**TABLE 2: Allowable Vertical Linesets**

Model	Liquid Line	Suction Line	Max Line Length - Units on Equal Level	Max Suction Line Riser - If OD Unit is Above ID Unit	Max Liquid Line Riser - If OD Unit is Below ID Unit
24	3/8"	3/4"	80 feet	25 feet	25 feet
36		7/8"			
48		1-1/8"			
60					

**SECTION III: UNIT INSTALLATION****LOCATION**

Before starting the installation, select and check the suitability of the location for both the indoor and outdoor unit. Observe all limitations and clearance requirements.

The outdoor unit must have sufficient clearance for air entrance to the condenser coil, air discharge, and service access. See Figure 1.

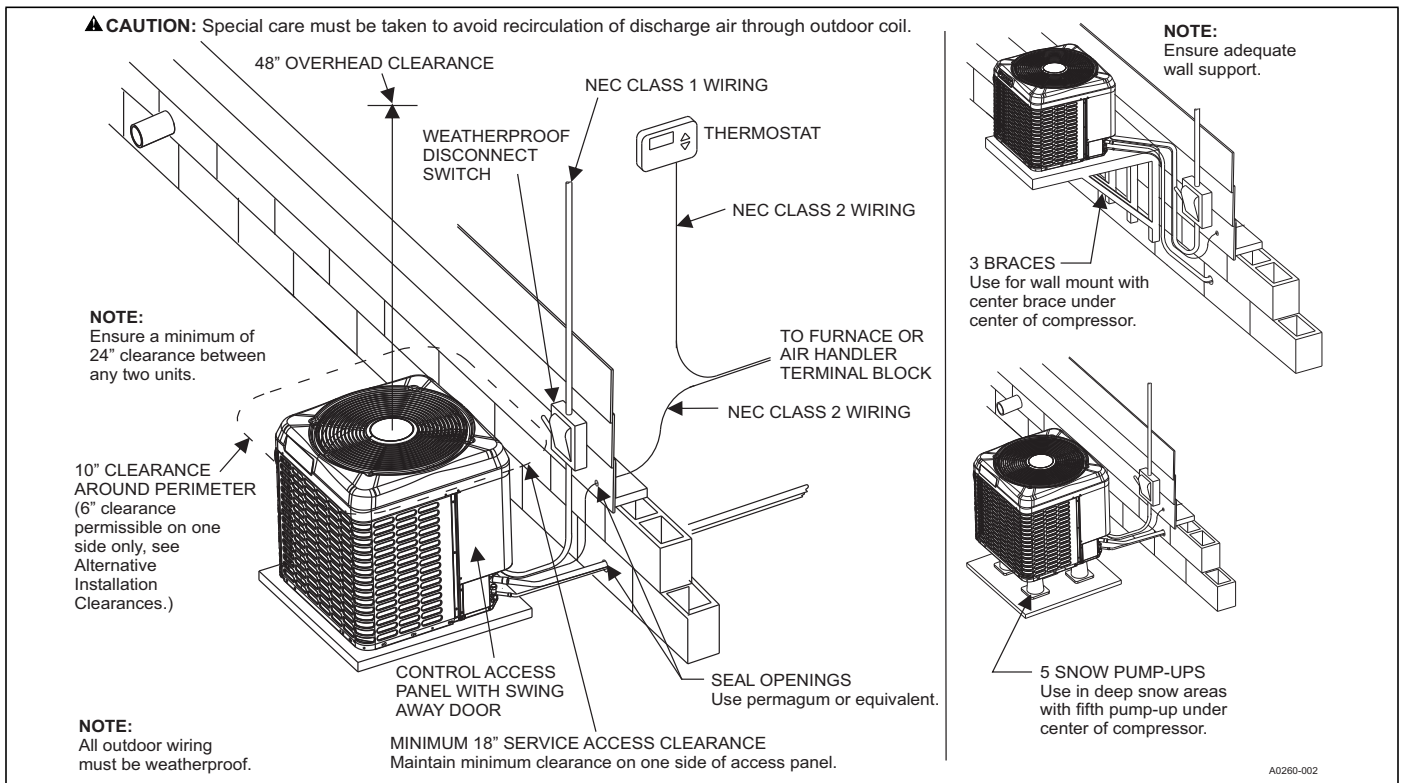
**NOTICE**

*For multiple unit installations, units must be spaced a minimum of 24" (61 cm) apart (coil face to coil face).*

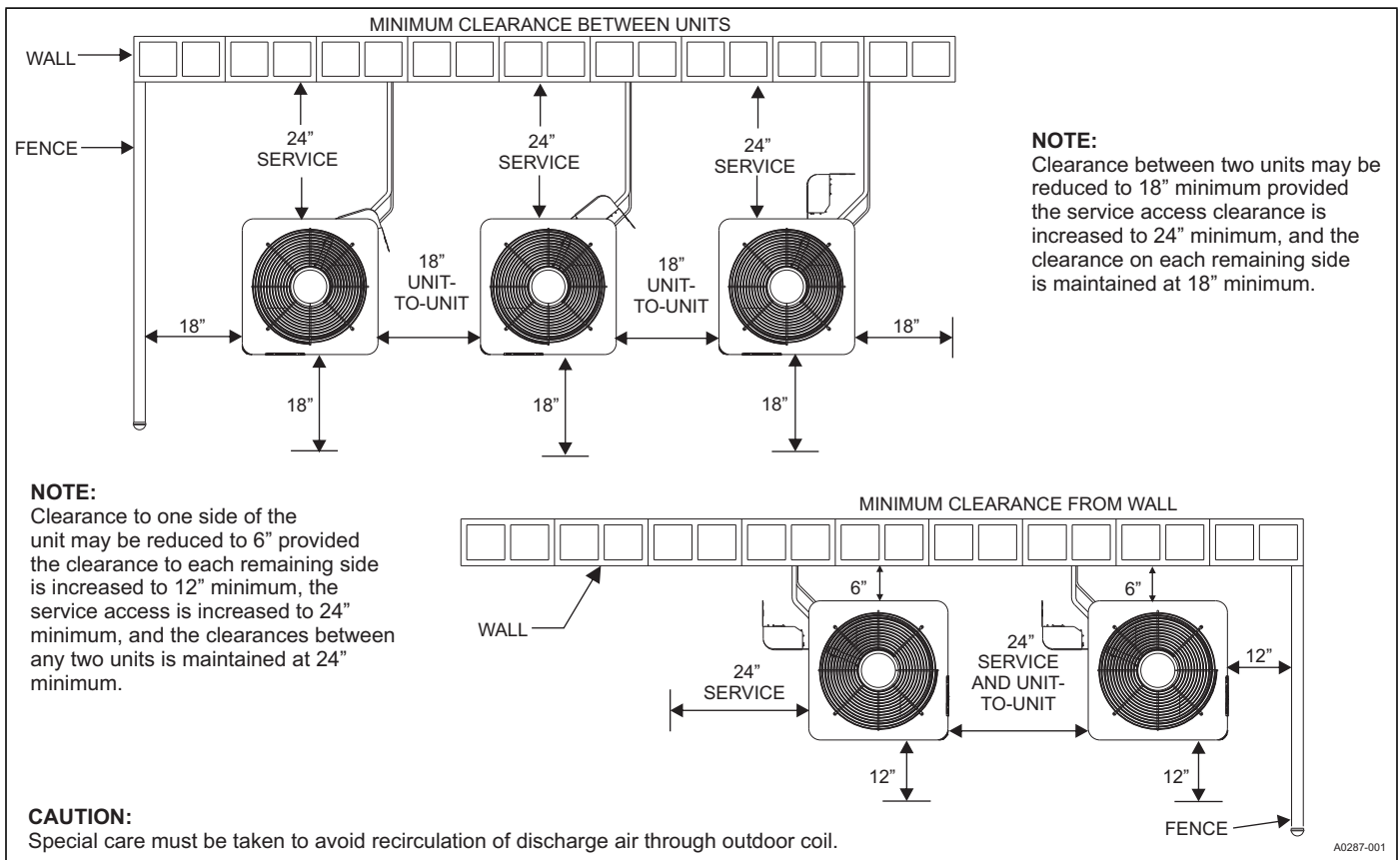
If the unit is to be installed on a hot sun exposed roof or a paved ground area that is seasonally hot, the unit should be raised sufficiently above the roof or ground to avoid taking the accumulated layer of hot air into the outdoor unit (which can cause the unit to derate prematurely).

If the system is being installed during seasonally cold weather of 55°F or below, the preferred method is to weigh in the charge. For charging or checking the system charge at 55°F or below, refer to the "Optional Cold Weather Charging" procedures near the end of SECTION VI: SYSTEM CHARGE. There is an Optional Cold Weather Charging accessory kit to prevent the outdoor unit from taking in cold air below 55°F. The kit part number can be found in the list of accessory kits at [www.upgnet.com](http://www.upgnet.com).

Provide adequate structural support for the unit.



**FIGURE 1:** Typical Installation Clearances



**FIGURE 2:** Alternative Installation Clearances

## ADD-ON REPLACEMENT/RETROFIT

When this unit is being used as a replacement for an existing R-410A unit, these are matched systems and the indoor coil and outdoor unit must be replaced. The following steps should be performed in order to insure proper system operation and performance. Line-set change out is also recommended.

1. Change-out of the indoor coil to an approved R-410A coil / air handling unit combination with the appropriate metering device.
2. Change-out of the lineset when replacing an R-22 unit with an R410-A unit is highly recommended to reduce cross-contamination of oils and refrigerants.
3. If change-out of the line set is not practical, then the following precautions should be taken.
  - Inspect the line set for kinks, sharp bends, or other restrictions, and for corrosion.
  - Determine if there are any low spots which might be serving as oil traps.
  - Flush the line set with a commercially available flush kit to remove as much of the existing oil and contaminants as possible.
  - Install a suction line filter-drier to trap any remaining contaminants, and remove after 50 hours of operation.
4. If the outdoor unit is being replaced due to a compressor burnout, then installation of a 100% activated alumina suction-line filter drier in the suction-line is required, in addition to the factory installed bi-flow liquid-line drier. Operate the system for 10 hours. Monitor the suction drier pressure drop. If the pressure drop exceeds 3 psig, replace both the suction-line and liquid-line driers. After a total of 10 hours run time where the suction-line pressure drop has not exceeded 3 psig, replace the liquid line drier, and remove the suction-line drier. Never leave a suction-line drier in the system longer than 50 hours of run time.

## GROUND INSTALLATION

The unit may be installed at ground level on a solid base that will not shift or settle, causing strain on the refrigerant lines and possible leaks. The unit must be installed in as level a position as possible while maintaining the clearances, shown in Figure 2.

Normal operating sound levels may be objectionable if the unit is placed directly under windows of certain rooms (bedrooms, study, etc.).

### ⚠ WARNING

*The outdoor unit should not be installed in an area where mud or ice could cause personal injury.*

Elevate the unit sufficiently to prevent any blockage of the air entrances by snow in areas where there will be snow accumulation. Check the local weather bureau for the expected snow accumulation in your area. Isolate the unit from rain gutters to avoid any possible wash out of the foundation.

## ROOF INSTALLATION

When installing units on a roof, the structure must be capable of supporting the total weight of the unit, including a pad, lintels, rails, etc., which should be used to minimize the transmission of sound or vibration into the conditioned space.

## WALL MOUNT INSTALLATION

Care must be taken to mount the outdoor unit on a solid base that is sloped to shed water, secure from settlement, and is isolated from the structural foundation or walls to prevent sound and vibration transmission into the living space.

On occasion, site conditions may require direct wall mounted brackets to be used to locate and support the outdoor unit. In these applications, care must be taken to address unit base pan support, structural integrity, safe access and serviceability, as well as the possible sound and vibration transmission into the structure. Wall mounting requires 3 mounting brackets and best served by a properly engineered solution.

See price pages for specific part number for your application.

## UNIT PLACEMENT

1. Provide a base in the pre-determined location.
2. Remove the shipping carton and inspect for possible damage.
3. Ensure that compressor tie-down bolts remain tightened.
4. Position the unit on the base provided.

## LIQUID LINE FILTER-DRIER

The outdoor unit filter drier is located on the liquid line inside the unit cabinet.

### ⚠ CAUTION

*Failure to use the same as the original factory drier or using a substitute drier or a granular type may result in damage to the equipment.*

### NOTICE

*Replacements for the liquid line drier must be exactly the same as marked on the original factory drier. See Source 1 for O.E.M. replacement driers.*

R-410A Filter-Drier Source 1 Part No.	Apply with Models
S1-32649682000	All

## PIPING CONNECTIONS

The outdoor condensing unit must be connected to the indoor evaporator coil using field supplied refrigerant grade (ACR) copper tubing that is internally clean and dry. Units should be installed only with the tubing sizes for approved system combinations as specified in tabular data sheet. The charge given is applicable for total tubing lengths up to 15 feet (4.6 m). See Application Data Part Number 247077 for installing tubing of longer lengths and elevation differences.

### NOTICE

*Using a larger than specified line size could result in oil return problems. Using too small a line will result in loss of capacity and other problems caused by insufficient refrigerant.*

### ⚠ WARNING

*Never install a suction-line filter drier in the liquid line of an R-410A system. Failure to follow this warning can cause a fire, injury or death.*

### ⚠ CAUTION

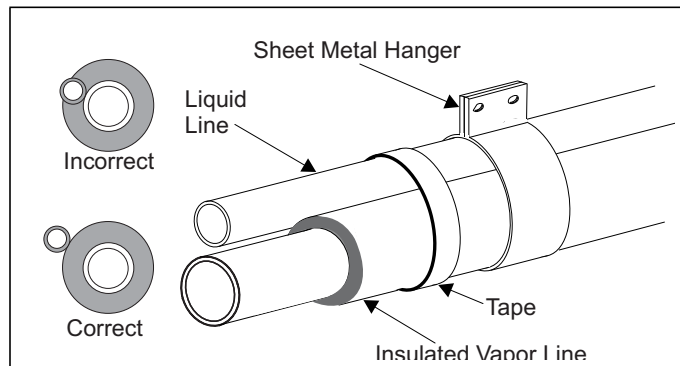
*This system uses R-410A refrigerant which operates at higher pressures than R-22. No other refrigerant may be used in this system. Gauge sets, hoses, refrigerant containers, and recovery system must be designed to handle R-410A. If you are unsure, consult the equipment manufacturer.*

## PRECAUTIONS DURING LINE INSTALLATION

Install the refrigerant lines with as few bends as possible. Care must be taken not to damage the couplings or kink the tubing. Use clean hard drawn copper tubing where no appreciable amount of bending around obstruction is necessary. If soft copper must be used, care must be taken to avoid sharp bends which may cause a restriction.

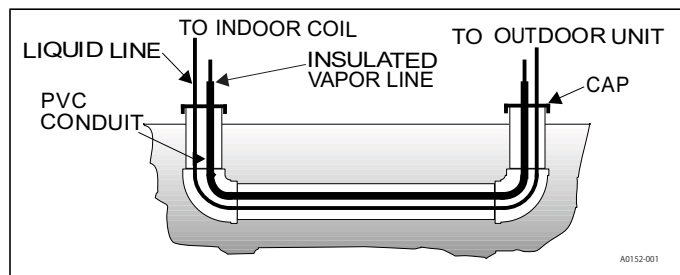
1. The lines should be installed so that they will not obstruct service access to the coil, air handling system, or filter.
2. Care must also be taken to isolate the refrigerant lines to minimize noise transmission from the equipment to the structure.
3. The vapor line must be insulated with a minimum of 1/2" foam rubber insulation (Armaflex or equivalent). Liquid lines that will be exposed to direct sunlight, high temperatures, or excessive humidity must also be insulated.

4. Tape and suspend the refrigerant lines as shown. DO NOT allow tube metal-to-metal contact. See Figure 3.



**FIGURE 3:** Insulation of Vapor Line

5. Use PVC piping as a conduit for all underground installations as shown in Figure 4. Buried lines should be kept as short as possible to minimize the build up of liquid refrigerant in the vapor line during long periods of shutdown.



**FIGURE 4:** Underground Installation

6. Pack fiberglass insulation and a sealing material such as permagum around refrigerant lines where they penetrate a wall to reduce vibration and to retain some flexibility.

#### PRECAUTIONS DURING BRAZING OF LINES

All outdoor unit and evaporator coil connections are copper-to-copper and should be brazed with a phosphorous-copper alloy material such as Silfos-5 or equivalent. DO NOT use soft solder. The outdoor units have reusable service valves on both the liquid and vapor connections. The total system refrigerant charge is retained within the outdoor unit during shipping and installation. The reusable service valves are provided to evacuate and charge per this instruction.

Serious service problems can be avoided by taking adequate precautions to assure an internally clean and dry system.

#### ⚠ CAUTION

*Dry nitrogen should always be supplied through the tubing while it is being brazed, because the temperature required is high enough to cause oxidation of the copper unless an inert atmosphere is provided. The flow of dry nitrogen should continue until the joint has cooled. Always use a pressure regulator and safety valve to insure that only low pressure dry nitrogen is introduced into the tubing. Only a small flow is necessary to displace air and prevent oxidation.*

#### PRECAUTIONS DURING BRAZING SERVICE VALVE

Precautions should be taken to prevent heat damage to the service valve by wrapping a wet rag around it, as shown in Figure 5. Also, protect all painted surfaces, insulation, and plastic base during brazing. After brazing, cool joint with wet rag.

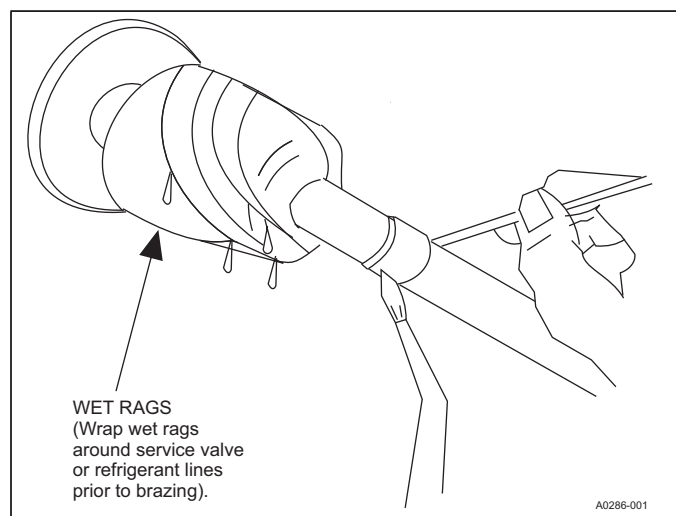
#### ⚠ WARNING

*This is not a backseating valve. The service access port has a valve core. Opening or closing valve does not close service access port. If the valve stem is backed out past the chamfered retaining wall, the O-ring can be damaged causing leakage or system pressure. This could force the valve stem out of the valve body possibly causing personal injury.*

The valve can be opened by removing the service valve cap, fully inserting an Allen wrench into the stem and backing out counter-clockwise until valve stem just touches the chamfered retaining wall.

#### Connect the refrigerant lines using the following procedure:

1. Remove the cap and Schrader core from both the liquid and vapor service valve service ports at the outdoor unit. Connect low pressure nitrogen to the liquid line service port.
2. Braze the liquid line to the liquid valve at the outdoor unit. Be sure to wrap the valve body with a wet rag. Allow the nitrogen to continue flowing.
3. Carefully remove the plugs from the indoor coil liquid and vapor connections at the indoor coil.



**FIGURE 5:** Heat Protection

#### ⚠ CAUTION

*Do not install any coil in a furnace which is to be operated during the heating season without attaching the refrigerant lines to the coil. The coil is under pressure which must be released to prevent excessive pressure build-up and possible coil damage.*

4. Braze the liquid line to the indoor coil liquid connection. Nitrogen should be flowing through the indoor coil.
5. Slide the grommet away from the vapor connection at the indoor coil. Braze the vapor line to the evaporator vapor connection. After the connection has cooled, slide the grommet back into its original position.
6. Protect the vapor valve with a wet rag and braze the vapor line connection to the outdoor unit. The nitrogen flow should be exiting the system from the vapor service port connection. After this connection has cooled, remove the nitrogen source from the liquid fitting service port.
7. Replace the Schrader core in the liquid and vapor valves.
8. Go to SECTION IV for Thermostatic Expansion Valve (TXV) installation.
9. Leak test all refrigerant piping connections including the service port flare caps to be sure they are leak tight. DO NOT OVERTIGHTEN (between 40 and 60 inch - lbs. maximum).

## NOTICE

Line set and indoor coil can be pressurized to 250 psig with dry nitrogen and leak tested with a bubble type leak detector. Then release the nitrogen charge.

Do not use the system refrigerant in the outdoor unit to purge or leak test.

- Evacuate the vapor line, indoor coil, and liquid line to 500 microns or less.
- Replace cap on service ports. Do not remove the flare caps from the service ports except when necessary for servicing the system.

## CAUTION

Do not connect manifold gauges unless trouble is suspected. Approximately 3/4 ounce of refrigerant will be lost each time a standard manifold gauge is connected.

- Release the refrigerant charge into the system. Open the liquid line valve first, then the vapor line valve by removing the plunger cap and turning the valve counter-clockwise using hex head wrenches. Valves are fully open when the valve stem is touching the chamfered retaining wall at the top of the valve. If the service valve is a ball type valve, use an adjustable end wrench to turn the valve stem one quarter turn counter-clockwise to open it. DO NOT over-turn or the valve stem may break or become damaged. See PRECAUTIONS DURING BRAZING SERVICE VALVE.
- Replace plunger cap finger tight, then tighten an additional 1/12 turn (1/2 hex flat). Cap must be replaced to prevent leaks.

## WARNING

Never attempt to repair any brazed connections while the system is under pressure. Personal injury could result.

See SECTION VI: SYSTEM CHARGE for checking and recording system charge.

## SECTION IV: COIL METERING DEVICES

A TXV is to be installed in the field. There is an installation manual that comes with the TXV kit. It is recommended to install the TXV kit prior to installation of coil and brazing of line set. Until brazing is completed and cooled, the TXV sensing bulb must not be installed.

The outdoor technical guide for outdoor units should be consulted for required TXV on the indoor coil. Check that there is no Schrader core installed in equalizer line. TXV will not function properly if a Schrader core is installed.

## CAUTION

### COIL UNDER PRESSURE.

Verify that pressure has been released by depressing Schrader valve core.

The coil requires a metering device to be added.

See outdoor unit documentation for correct TXV to be used.

## NOTICE

To prevent moisture and contaminants from entering the system, the coil should not be open to atmosphere for extended periods of time. If the coil cannot be brazed into the refrigeration system during a routine installation period, the ends should be temporarily closed or plugged. For a short term delay, use masking tape over the ends of the copper tubing to close the tube from the air. For a longer term delay, use plugs or caps. There is no need to purge the coil if this procedure is followed.

## THERMOSTATIC EXPANSION VALVE (TXV) INSTALLATION

## CAUTION

Outdoor unit model numbers ending with an "H" have a factory installed hard start kit which is required when a TXV is installed. Outdoor unit model numbers with no "H" ending do not require a hard start kit unless local regulations dictate it.

The following are basic steps for installation. For detailed instructions, refer to the Installation Instructions accompanying the TXV kit. Install TXV kit as follows:

## IMPORTANT

Refer to the Technical Guide for the unit to determine the proper TXV kit to be used on this product.

- Relieve the holding charge by depressing Schrader core on the suction manifold stub out.
- After holding charge is completely discharged, loosen and remove the Schrader core.
- Place a backup wrench on distributor, loosen and remove brass distributor nut. Retain brass nut for use on liquid line. Keep Teflon washer in place and discard clear disk.
- Install the thermal expansion valve to the distributor assembly with supplied fittings. Ensure Teflon washer is seated in distributor. Hand tighten and turn an additional 1/4 turn to seal. DO NOT OVERTIGHTEN FITTINGS. See Figure 6.

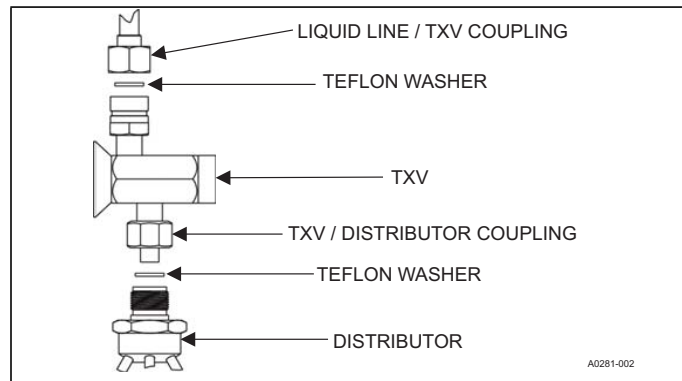


FIGURE 6: TXV Installation

## CAUTION

Do not over-torque. Do not use slip joint pliers. This will distort the aluminum distributor and the brass fitting (potentially causing leaks).

- Slide the brass distributor nut removed in step 3 over the supplied liquid line. Place supplied Teflon washer from TXV kit in place on TXV, and install liquid line to the top of the thermal expansion valve. Adjust assembly so liquid line aligns with hole in access panel. Hand tighten the liquid line, and apply an additional 1/4 turn to seal.

## WARNING

Schrader valve core **MUST NOT** be installed with TXV installation. Poor system performance or system failure could result.

6. Install the TXV equalizer line onto the vapor line by hand tightening the 1/4" SAE coupling nut to the equalizer fitting, and apply an additional 1/3 turn to seal. See Figure 7.

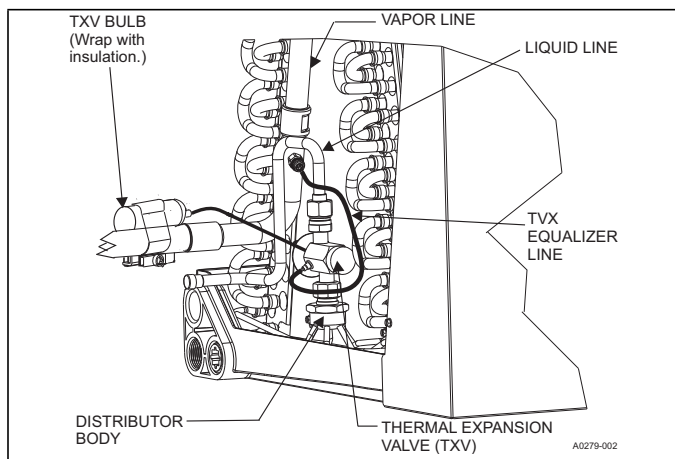


FIGURE 7: TXV Bulb and Equalizer Line Installations

**CAUTION**

*In all cases, mount the TXV temperature sensing bulb after vapor line is brazed and sufficiently cooled.  
Failure to use suction line split grommet may result in TXV failure.*

7. Pass the temperature sensing bulb tube for the TXV through the tube opening in the split grommet of the access panel.
8. Install the TXV bulb to the vapor line near the cabinet, using the bulb clamp(s) furnished with the TXV assembly. Ensure the bulb is making maximum contact. See Figures 7, 8 & 9, and accomplish the following:
  - a. If possible, install the temperature bulb on a horizontal run of the vapor line. Ensure that the bulb is installed at a 10 o'clock or 2 o'clock position. See Figure 8.

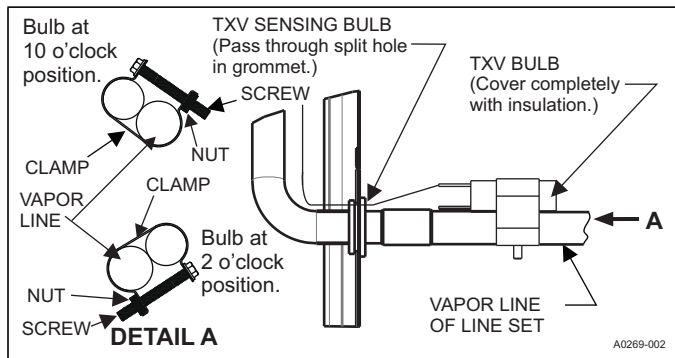


FIGURE 8: Proper Bulb Location

- b. If bulb installation is made on a vertical run, ensure that the bulb is a minimum of 16 inches (20.3 cm) away from elbow coming out of the coil. Position the bulb with the tail of the bulb at the top, so that the bulb acts as a reservoir. See Figure 9.

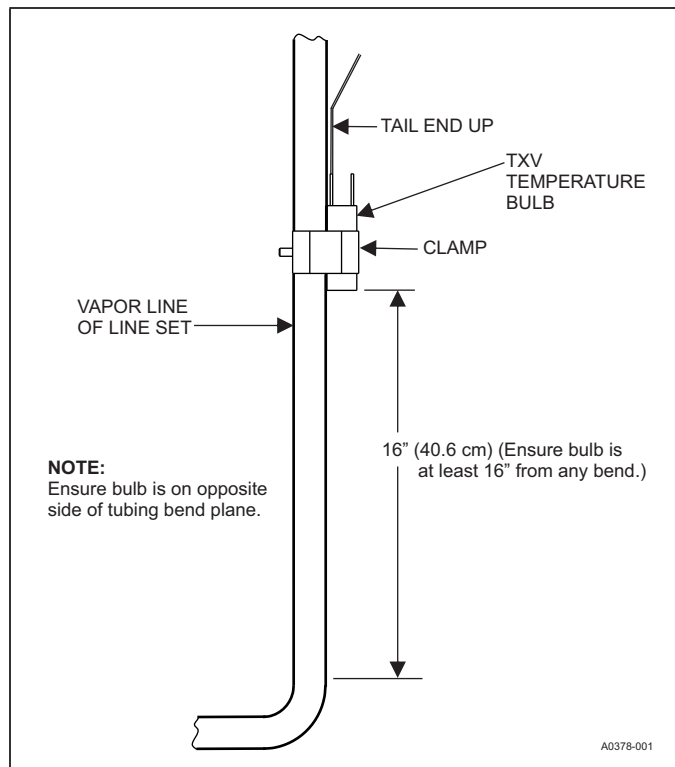


FIGURE 9: Vertical Temperature Bulb Orientation

- c. Insulate the bulb using thermal insulation provided to protect it from the effect of the surrounding ambient temperature. Cover completely to insulate.

9. After line set is installed, leak test the system.

## SECTION V: EVACUATION

Evacuate the system to 500 microns or less. If a leak is suspected, leak test with dry nitrogen to locate the leak. Repair the leak and test again. To verify that the system has no leaks, simply close the valve to the vacuum pump suction to isolate the pump and hold the system under vacuum. Watch the micron gauge for a few minutes. If the micron gauge indicates a steady and continuous rise, it's an indication of a leak. If the gauge shows a rise, then levels off after a few minutes and remains fairly constant, it's an indication that the system is leak free but still contains moisture and may require further evacuation if the reading is above 500 microns.

## SECTION VI: SYSTEM CHARGE

**IMPORTANT**

To ensure that your unit performs at the published levels, it is important to charge the unit according to these directions.

The factory charge in the outdoor unit includes enough refrigerant for the unit, 15 ft. (4.6 m) of refrigerant piping, and the smallest indoor coil/air handler match-up. Some indoor coil/air handler matches may require additional charge.

## DETERMINING THE INITIAL CHARGE

1. Start with the outdoor unit factory charge from the Tabular Data Sheet.
2. Add indoor coil adjustment (if any) from the Tabular Data Sheet.
3. If the line set is longer than 15 feet (4.6m), calculate the additional refrigerant using the Tabular Data Sheet.
4. Adjust charge according to the charging chart. See Servicing the Unit section for details.
5. Total system charge = item 1 + item 2 + item 3 +/- item 4.
6. Permanently mark the unit data plate with the total amount of refrigerant in the system.

**CAUTION**

If a field-installed device is placed in the inner-connecting lines, that adds a significant amount of charge (ex: refrigerant mass flow meter but not a drier or muffler) the unit may not perform as designed. If such a performance-affecting device is installed and it is possible to check the unit in heating mode, the unit pressure should be confirmed in heating mode (see "Servicing the unit in heating mode" section) to assure it is operating as designed.

## SERVICING THE UNIT

**NOTICE**

Make sure your gauges are properly calibrated before proceeding. For the proper process to calibrate gauges please reference the Unitary Products Academy.

The unit includes a cooling charging chart. The subcooling charging charts are also included in Tables 4-7. The heating charging charts vary by indoor coil and are located in Tables 8-16.

When confirming or adjusting the charge, if possible, check the unit in heating mode, matching the values shown regardless of indoor coil orientation. Otherwise, use the cooling chart, matching the subcooling value on the chart, unless the indoor coil is in the downflow or horizontal-right orientation, in which case subtract subcooling from the charging chart value according to the following table:

**TABLE 3:** Subcool Adjustment Levels for Downflow and Horizontal-right Installations

Unit Size	Reduce subcooling value on charging chart by this amount:
24	5
36	3
48	6
60	4

## DETERMINING INDOOR AIRFLOW

To determine rated air flow for a specific match, consult the technical literature at [www.upgnet.com](http://www.upgnet.com). When attempting to match this air flow, select the appropriate speed tap, measure the actual flow, and fine tune as necessary.

**NOTICE**

Measure the actual air flow. Do not just check the jumper pin setting tables. Use a manometer to measure actual system static. If unsure, reference the unitary products academy.

## COOLING CHARGING CHARTS

**TABLE 4:** YZT24B21S Subcooling Charging Chart - All Matching Coils

OUTDOOR AMBIENT DB (F)	INDOOR WET BULB (°F AT 80°F DRY BULB)			
	57	62	67	72
	PRESSURE (PSIG) & SUBCOOLING (°F) AT LIQUID BASE VALVE			
55	198 (12)	200 (8)	202 (8)	205 (7)
60	213 (12)	214 (8)	216 (8)	219 (7)
65	227 (11)	228 (8)	230 (8)	232 (7)
70	241 (10)	242 (8)	244 (8)	246 (7)
75	255 (9)	256 (8)	258 (8)	259 (7)
80	278 (9)	279 (8)	282 (8)	283 (7)
85	301 (9)	302 (8)	305 (8)	307 (7)
90	324 (9)	326 (8)	329 (8)	330 (7)
95	347 (8)	349 (8)	353 (8)	354 (7)
100	374 (8)	376 (7)	379 (7)	380 (7)
105	401 (9)	402 (7)	405 (7)	407 (7)
110	427 (9)	429 (7)	432 (7)	433 (7)
115	454 (9)	455 (7)	458 (7)	460 (7)
120	481 (9)	481 (7)	485 (7)	487 (7)
125	507 (9)	508 (7)	511 (7)	513 (7)

**TABLE 5:** YZT36B21S Subcooling Charging Chart - All Matching Coils

OUTDOOR AMBIENT DB (F)	INDOOR WET BULB (°F AT 80°F DRY BULB)			
	57	62	67	72
	PRESSURE (PSIG) & SUBCOOLING (°F) AT LIQUID BASE VALVE			
55	192 (9)	193 (8)	196 (9)	196 (9)
60	207 (9)	208 (8)	210 (8)	211 (9)
65	222 (8)	223 (7)	225 (8)	226 (8)
70	237 (8)	238 (7)	239 (7)	241 (7)
75	251 (7)	253 (6)	254 (7)	256 (7)
80	273 (7)	274 (6)	275 (7)	278 (7)
85	294 (7)	294 (6)	297 (7)	300 (7)
90	315 (7)	315 (6)	318 (7)	321 (7)
95	336 (6)	336 (6)	340 (7)	343 (7)
100	363 (6)	364 (6)	366 (6)	370 (6)
105	391 (6)	391 (6)	394 (6)	397 (6)
110	418 (6)	418 (6)	421 (6)	424 (6)
115	445 (6)	446 (6)	448 (6)	452 (6)
120	472 (6)	473 (6)	475 (6)	479 (6)
125	499 (6)	500 (6)	503 (6)	506 (6)



**TABLE 6: YZT48B21S Subcooling Charging Chart - All Matching Coils**

OUTDOOR AMBIENT DB (F)	INDOOR WET BULB (°F AT 80°F DRY BULB)			
	57	62	67	72
	PRESSURE (PSIG) & SUBCOOLING (°F) AT LIQUID BASE VALVE			
55	200 (10)	206 (11)	209 (12)	213 (13)
60	215 (10)	221 (11)	224 (11)	227 (12)
65	229 (9)	236 (10)	239 (10)	242 (11)
70	243 (8)	251 (9)	255 (10)	257 (10)
75	257 (7)	266 (8)	270 (9)	272 (9)
80	280 (8)	288 (8)	292 (9)	294 (9)
85	302 (8)	311 (8)	315 (9)	317 (9)
90	324 (8)	333 (8)	337 (9)	340 (9)
95	346 (8)	355 (8)	360 (9)	362 (9)
100	374 (8)	384 (8)	388 (9)	391 (9)
105	403 (8)	412 (8)	417 (9)	420 (9)
110	431 (8)	441 (8)	445 (9)	448 (9)
115	459 (8)	469 (8)	473 (9)	477 (9)
120	487 (8)	498 (8)	501 (8)	505 (9)
125	515 (7)	526 (8)	530 (8)	534 (9)

**TABLE 7: YZT60B21S Subcooling Charging Chart - All Matching Coils**

OUTDOOR AMBIENT DB (F)	INDOOR WET BULB (°F AT 80°F DRY BULB)			
	57	62	67	72
	PRESSURE (PSIG) & SUBCOOLING (°F) AT LIQUID BASE VALVE			
55	193 (10)	192 (9)	193 (10)	194 (11)
60	212 (10)	211 (9)	213 (10)	213 (11)
65	230 (10)	230 (9)	232 (10)	232 (11)
70	248 (10)	249 (9)	251 (10)	252 (11)
75	266 (10)	268 (9)	271 (10)	272 (11)
80	290 (10)	291 (9)	294 (10)	295 (11)
85	313 (10)	313 (9)	317 (10)	318 (10)
90	336 (10)	336 (9)	340 (10)	341 (10)
95	359 (10)	359 (9)	363 (10)	364 (10)
100	388 (10)	387 (9)	391 (10)	393 (10)
105	417 (11)	416 (9)	420 (10)	421 (10)
110	446 (11)	444 (10)	448 (10)	450 (10)
115	475 (11)	472 (10)	476 (10)	479 (10)
120	504 (11)	501 (10)	504 (10)	507 (10)
125	533 (11)	529 (10)	533 (10)	536 (10)

HEATING CHARGING CHARTS

**TABLE 8: YZT24 Heat Charging Chart - CF/CM/CU24, AE24, AVC24**

YZT / HL19 / HC19		CF/CM/CU24, AE24, AVC24																	
CFM	Ambient Temperature (°F)	60			47			40			30			17			10		
	Indoor Temperature (°F)	60	70	80	60	70	80	60	70	80	60	70	80	60	70	80	60	70	80
650	Liq. Pressure (Subcool)	356 (27)	403 (28)	450 (30)	327 (30)	374 (31)	421 (33)	310 (30)	358 (32)	407 (34)	281 (28)	334 (32)	388 (36)	270 (35)	327 (37)	384 (41)	267 (36)	321 (40)	373 (45)
850	Liq. Pressure Subcool	324 (23)	368 (24)	413 (27)	301 (27)	345 (28)	391 (30)	287 (28)	333 (29)	380 (31)	269 (27)	316 (30)	363 (33)	266 (35)	317 (37)	369 (40)	260 (33)	308 (37)	356 (41)
1050	Liq. Pressure (Subcool)	292 (21)	334 (22)	377 (23)	275 (24)	318 (25)	360 (27)	266 (25)	310 (27)	353 (29)	257 (27)	299 (28)	340 (30)	264 (35)	308 (36)	338 (39)	250 (31)	295 (35)	331 (39)

**TABLE 9: YZT24 Heat Charging Chart - CF/CM/CU30, AE30, AVC30**

YZT / HL19 / HC19		CF/CM/CU30, AE30, AVC30																	
CFM	Ambient Temperature (°F)	60			47			40			30			17			10		
	Indoor Temperature (°F)	60	70	80	60	70	80	60	70	80	60	70	80	60	70	80	60	70	80
650	Liq. Pressure (Subcool)	359 (29)	406 (30)	454 (32)	329 (32)	376 (33)	424 (36)	312 (32)	361 (35)	410 (37)	284 (30)	337 (35)	391 (39)	263 (33)	318 (36)	374 (40)	261 (35)	313 (38)	364 (43)
850	Liq. Pressure Subcool	326 (25)	371 (26)	416 (29)	303 (29)	348 (30)	394 (32)	290 (30)	336 (31)	382 (33)	271 (29)	318 (32)	366 (36)	260 (33)	309 (36)	359 (38)	253 (32)	300 (36)	347 (40)
1050	Liq. Pressure (Subcool)	294 (23)	337 (24)	379 (25)	277 (26)	320 (27)	363 (29)	268 (27)	312 (29)	356 (31)	259 (29)	301 (30)	343 (32)	257 (33)	300 (35)	338 (37)	243 (29)	287 (33)	331 (37)

**TABLE 10: YZT24 Heat Charging Chart - CF/CM/CU36**

YZT / HL19 / HC19		CF/CM/CU36																	
CFM	Ambient Temperature (°F)	60			47			40			30			17			10		
	Indoor Temperature (°F)	60	70	80	60	70	80	60	70	80	60	70	80	60	70	80	60	70	80
650	Liq. Pressure (Subcool)	346 (25)	392 (26)	438 (28)	318 (28)	363 (29)	409 (31)	301 (28)	348 (30)	396 (32)	274 (26)	325 (30)	377 (34)	247 (29)	299 (31)	351 (34)	245 (30)	294 (33)	341 (38)
850	Liq. Pressure Subcool	315 (22)	358 (23)	402 (25)	292 (25)	336 (26)	380 (28)	279 (26)	324 (27)	369 (29)	262 (25)	307 (28)	353 (31)	244 (29)	290 (31)	337 (33)	238 (28)	282 (31)	326 (34)
1050	Liq. Pressure (Subcool)	283 (20)	325 (21)	366 (22)	268 (23)	309 (24)	350 (25)	259 (24)	301 (25)	343 (27)	250 (25)	290 (26)	331 (28)	242 (29)	282 (30)	323 (32)	228 (25)	270 (29)	311 (32)

TABLE 11: YZT24 Heat Charging Chart - AE36, AVC36

YZT / HL19 / HC19		AE36, AVC36																	
CFM	Ambient Temperature (°F)	60			47			40			30			17			10		
	Indoor Temperature (°F)	60	70	80	60	70	80	60	70	80	60	70	80	60	70	80	60	70	80
650	Liq. Pressure (Subcool)	346 (24)	391 (25)	437 (27)	317 (27)	362 (28)	408 (30)	300 (27)	348 (29)	395 (31)	273 (25)	324 (29)	376 (33)	243 (27)	295 (29)	347 (32)	243 (28)	290 (31)	337 (35)
850	Liq. Pressure (Subcool)	314 (21)	357 (22)	401 (24)	292 (24)	335 (25)	379 (27)	279 (25)	323 (26)	368 (28)	261 (24)	306 (27)	352 (30)	240 (27)	286 (29)	333 (31)	234 (26)	278 (29)	322 (32)
1050	Liq. Pressure (Subcool)	283 (19)	324 (20)	365 (21)	267 (22)	308 (23)	350 (24)	258 (23)	300 (24)	343 (26)	249 (24)	290 (25)	330 (27)	238 (27)	278 (28)	319 (30)	225 (24)	266 (27)	307 (30)

TABLE 12: YZT36 Heat Charging Chart - CF/CM/CU36, AE36, AVC36

YZT / HL19 / HC19		CF/CM/CU36, AE36, AVC36																	
CFM	Ambient Temperature (°F)	60			47			40			30			17			10		
	Indoor Temperature (°F)	60	70	80	60	70	80	60	70	80	60	70	80	60	70	80	60	70	80
950	Liq. Pressure (Subcool)	392 (36)	438 (35)	485 (34)	363 (39)	412 (39)	461 (40)	354 (43)	407 (44)	459 (45)	351 (50)	396 (49)	442 (48)	317 (45)	369 (46)	422 (47)	299 (42)	344 (43)	389 (46)
1200	Liq. Pressure (Subcool)	364 (35)	409 (34)	453 (33)	337 (36)	384 (36)	431 (37)	331 (40)	381 (41)	431 (42)	321 (43)	369 (43)	417 (44)	297 (39)	346 (40)	395 (42)	282 (39)	330 (40)	379 (42)
1450	Liq. Pressure (Subcool)	336 (34)	379 (33)	422 (32)	313 (34)	358 (34)	402 (35)	309 (36)	357 (37)	404 (40)	293 (37)	343 (39)	393 (41)	277 (35)	323 (37)	369 (39)	265 (36)	316 (37)	368 (39)

TABLE 13: YZT36 Heat Charging Chart -CF/CM/CU42

YZT / HL19 / HC19		CF/CM/CU42																	
CFM	Ambient Temperature (°F)	60			47			40			30			17			10		
	Indoor Temperature (°F)	60	70	80	60	70	80	60	70	80	60	70	80	60	70	80	60	70	80
950	Liq. Pressure (Subcool)	385 (35)	431 (34)	477 (33)	357 (38)	405 (38)	453 (39)	348 (42)	399 (43)	451 (44)	345 (49)	389 (48)	434 (46)	309 (43)	360 (44)	411 (45)	292 (41)	335 (42)	379 (44)
1200	Liq. Pressure (Subcool)	358 (34)	401 (33)	445 (32)	331 (35)	377 (35)	423 (37)	325 (39)	374 (40)	423 (41)	316 (42)	363 (42)	410 (43)	290 (38)	337 (39)	386 (41)	275 (38)	322 (39)	369 (41)
1450	Liq. Pressure (Subcool)	330 (33)	372 (32)	415 (31)	307 (33)	351 (33)	395 (34)	303 (35)	350 (37)	397 (39)	288 (37)	337 (38)	386 (40)	270 (34)	315 (36)	360 (38)	259 (35)	308 (36)	359 (38)

TABLE 14: YZT36 Heat Charging Chart – CF/CM/CU48, CF/CM/CU60, AE42, AE48, AVC42, AVC48, AVC60

YZT / HL19 / HC19		CF/CM/CU48, AE42, AVC42, AVC48, AVC60																	
CFM	Ambient Temperature (°F)	60			47			40			30			17			10		
	Indoor Temperature (°F)	60	70	80	60	70	80	60	70	80	60	70	80	60	70	80	60	70	80
950	Liq. Pressure (Subcool)	365 (32)	409 (31)	452 (30)	338 (34)	384 (34)	429 (35)	330 (38)	379 (39)	427 (40)	327 (44)	369 (43)	411 (42)	294 (42)	342 (43)	391 (44)	277 (40)	318 (41)	360 (43)
1200	Liq. Pressure (Subcool)	339 (31)	381 (30)	422 (29)	314 (32)	358 (32)	402 (33)	308 (35)	355 (36)	402 (37)	299 (38)	344 (38)	389 (39)	275 (37)	320 (38)	366 (40)	261 (37)	306 (38)	351 (40)
1450	Liq. Pressure (Subcool)	313 (30)	353 (29)	394 (28)	292 (30)	333 (30)	375 (31)	288 (32)	332 (33)	377 (35)	273 (33)	319 (34)	366 (36)	257 (33)	299 (35)	342 (37)	246 (34)	293 (35)	341 (37)

**TABLE 15:** YZT48 Heat Charging Chart - All Matching Coils

YZT / HL19 / HC19		All Coils																	
CFM	Ambient Temperature (°F)	60			47			40			30			17			10		
	Indoor Temperature (°F)	60	70	80	60	70	80	60	70	80	60	70	80	60	70	80	60	70	80
1350	Liq. Pressure (Subcool)	347 (21)	396 (21)	445 (22)	320 (20)	345 (20)	371 (20)	312 (21)	359 (20)	406 (20)	294 (19)	339 (21)	385 (23)	249 (21)	289 (20)	329 (20)	239 (20)	274 (17)	309 (15)
1600	Liq. Pressure (Subcool)	325 (20)	373 (20)	421 (20)	304 (19)	331 (19)	358 (19)	296 (19)	342 (19)	388 (19)	279 (18)	323 (18)	369 (19)	240 (20)	275 (19)	311 (18)	230 (18)	264 (15)	300 (13)
1850	Liq. Pressure (Subcool)	305 (19)	350 (19)	397 (19)	288 (18)	317 (18)	346 (18)	280 (18)	325 (18)	371 (18)	265 (17)	309 (16)	354 (15)	230 (19)	262 (16)	295 (15)	222 (18)	256 (15)	291 (11)

**TABLE 16:** YZT60 Heat Charging Chart - All Matching Coils

YZT / HL19 / HC19		All Coils																	
CFM	Ambient Temperature (°F)	60			47			40			30			17			10		
	Indoor Temperature (°F)	60	70	80	60	70	80	60	70	80	60	70	80	60	70	80	60	70	80
1500	Liq. Pressure (Subcool)	339 (17)	382 (18)	426 (19)	328 (24)	374 (26)	420 (28)	314 (26)	358 (27)	401 (29)	296 (26)	339 (28)	383 (29)	273 (19)	321 (32)	370 (44)	263 (25)	313 (37)	364 (51)
1800	Liq. Pressure (Subcool)	316 (16)	358 (16)	400 (17)	306 (22)	350 (24)	396 (25)	294 (24)	336 (24)	378 (25)	277 (24)	322 (25)	367 (28)	266 (26)	305 (33)	346 (42)	259 (33)	303 (39)	348 (46)
2100	Liq. Pressure (Subcool)	293 (16)	334 (16)	375 (16)	284 (20)	327 (22)	372 (24)	274 (21)	314 (22)	355 (23)	259 (21)	305 (24)	350 (26)	259 (35)	290 (37)	323 (40)	255 (44)	293 (42)	332 (42)

**SECTION VII: ELECTRICAL CONNECTIONS**

**GENERAL INFORMATION & GROUNDING**

Check the electrical supply to be sure that it meets the values specified on the unit nameplate and wiring label.

Power wiring, control (low voltage) wiring, disconnect switches and over current protection must be supplied by the installer. Wire size should be sized per NEC requirements.

For servicing of the equipment the control box can slide down and swing open. Considerations for running the electrical supply and power control wiring should be made to utilize this swing open feature for future service work. You will not need to drop/swing the box open for installation of the electrical supply and power wiring, just account for the motion the box will have in the wire routing.

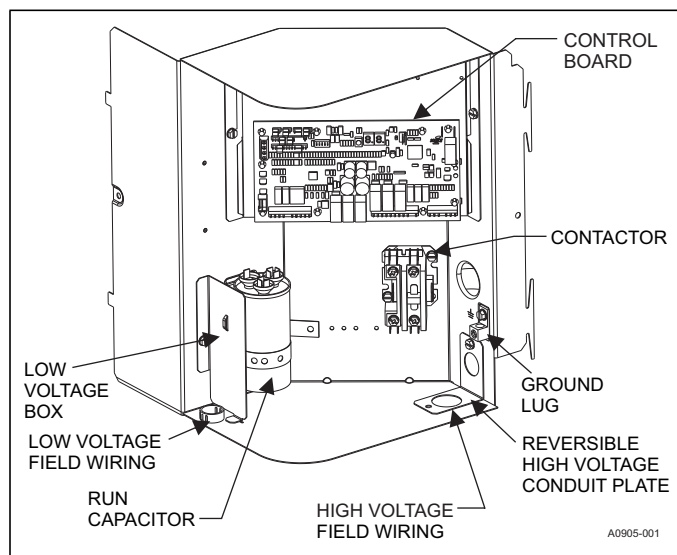
**NOTICE**

*A flexible electrical whip must be installed in order to use the swing away function of the control box. Other type electrical whips require the wiring to be disconnected in order to swing the control box open.*

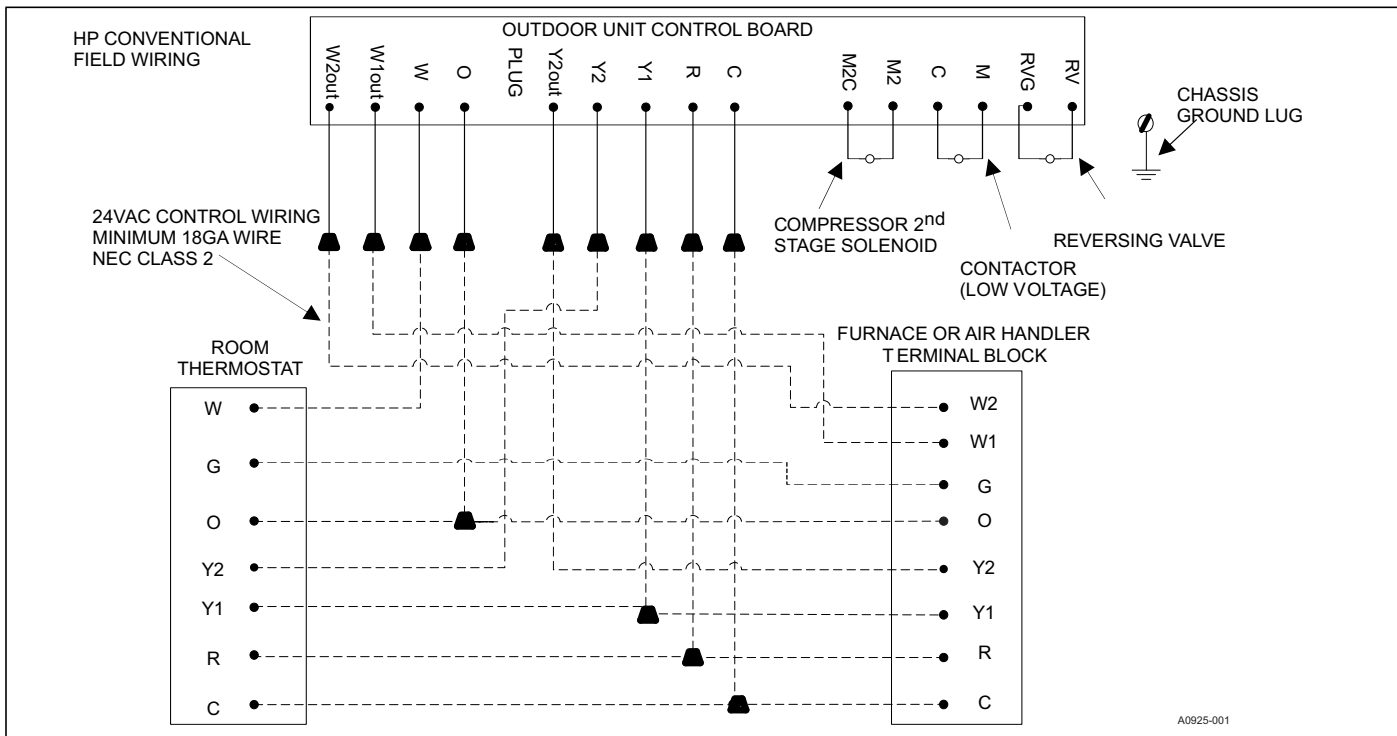
**CAUTION**

*All field wiring must **USE COPPER CONDUCTORS ONLY** and be in accordance with Local, National, Fire, Safety & Electrical Codes. This unit must be grounded with a separate ground wire in accordance with the above codes.*

The complete connection diagram and schematic wiring label is located on the inside surface of the unit service access panel. An example of typical field connections can be found in Figure 11.



**FIGURE 10:** Outdoor Unit Control Box



**FIGURE 11:** Typical 2-Stage Conventional Field Wiring - HP

### FIELD CONNECTIONS POWER WIRING

1. Install the proper size, weatherproof disconnect switch outdoors and within sight of the unit, per local code.
2. Remove the screws at the top and sides of the corner cover. Slide the control box cover down and remove from the unit.
3. Run power wiring from the disconnect switch to the unit.
4. Route wires from disconnect through power wiring exit provided and into the unit control box, as shown in Figure 1, and view the openings in Figure 10.
5. Make the power supply connections to the contactor.

### FIELD CONNECTIONS CONTROL WIRING

This system is equipped to be both serial communication capable (COMM) or conventionally wired. First determine which setup you are going to apply for the application, then follow the necessary steps.

#### **DO NOT CUT THE MOLEX PLUGS OFF UNTIL YOU HAVE DETERMINED WHICH METHOD TO CONNECT TO.**

- Conventional wiring consists of nine wires leaving the control board connected to (R, C, Y1, Y2, Y2OUT, O, W, W1OUT, and W2OUT) where they end up in a 12 pin Molex connector.
- Serial Communication consists of four wires leaving the control board connected to (B-, C, R, A+) where four wires end up in a 4 pin Molex connector.

You will only connect to one of the two harnesses. Leave the connector on the harness that is not being used to prevent a possible short from the 24VAC to ground, as some wires in both conventional and serial communication have power applied from the other harness source depending on which is connected. Cut the Molex connector off of the wiring harness being used and connect it to the field low-voltage wiring, using wire connectors.

#### **Terminals on the board from the following pin locations will have power applied:**

- Communicating block (B-, C, R, A+); the R terminal/wire will have 24VAC.
- Conventional block (R, C, Y1, Y2, Y2OUT, O, W, W1OUT, and W2OUT); the R, Y2OUT, W1OUT, and W2OUT terminal/wires will have 24VAC.

If any of these connections have an unterminated wire at the end, it needs to be properly capped to prevent a possible short to ground.

#### **Conventional Wiring**

1. Route the 24-volt control wiring (NEC Class 2) from the outdoor unit, to the indoor unit, and to the thermostat in the steps below.
2. Trace the harness out where it ends in a large 12 pin Molex connector, inside the low voltage box. Clip the 12 pin Molex connector and discard.
3. Y2out needs to be connected to the indoor control to cycle between high and low speed airflow. Pull this wire out from under the label, strip the end of it, and connect it to the indoor control.
4. Strip the remaining wires (R,C,Y1,Y2,W, W1 Out, W2 Out) and make the necessary thermostat connections, noted in the thermostat wiring diagrams. Refer to Figures 15-20.
5. Replace the control box cover removed in Step 2 of the FIELD CONNECTIONS POWER WIRING procedures.
6. All field wiring should be in accordance with national electrical codes (NEC) and/or local-city codes.
7. Mount the thermostat approximately 5 ft. above the floor, where it will be exposed to normal room air circulation. Do not place it on an outside wall or where it is exposed to the radiant effect from exposed glass, appliances, drafts from outside doors, or supply air vents.

#### **Serial Communication Wiring**

1. Route the 24-volt control wiring (NEC Class 2) from the outdoor unit, to the indoor unit, and to the thermostat in the steps below.
2. Trace the communicating harness from the (B-, R, C, A+) block where it ends in a 4 pin Molex connector, inside the low voltage box. Clip the 4 pin Molex connector and discard.
3. Strip the four wires and make the necessary thermostat connections noted in the thermostat wiring diagram. See figures 13 & 14.
4. If desired, you can unplug the conventional wire harness from the control board and leave it in the outdoor unit for future use.
5. Replace the control box cover, removed in Step 2 of the FIELD CONNECTIONS POWER WIRING procedures.

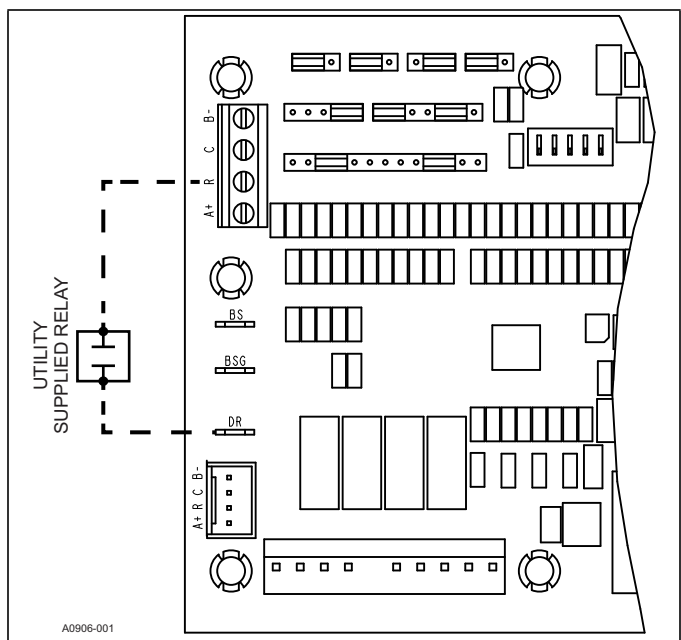
- All field wiring should be in accordance with national electrical codes (NEC) and/or local-city codes.
- Mount the thermostat approximately 5 ft. above the floor, where it will be exposed to normal room air circulation. Do not place it on an outside wall or where it is exposed to the radiant effect from exposed glass, appliances, drafts from outside doors, or supply air vents.

**NOTICE**

To eliminate erratic operation, seal the hole in the wall at the thermostat with permagum or equivalent to prevent air drafts affecting the operation of in the thermostat.

**Demand Response (Load Shedding)**

The outdoor control has a conventional 24VAC input (DR) for utility demand response signals. When a 24VAC signal is present on the DR input with a **communicating system**, the HX™ thermostat will adjust the indoor temperature setpoint by the installer selected setting. For further details on available settings, please refer to the HX™ thermostat installation and operation manual. With a **non-communicating system**, a 24VAC signal on the DR terminal will not allow the system to run in second stage, cooling operation only. The DR input terminal location can be found in Figure 12.



**FIGURE 12:** Demand Response Wiring

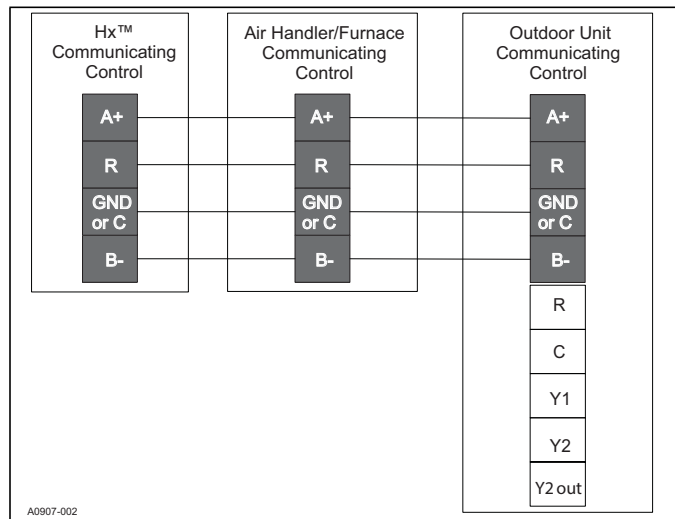
**DEHUMIDIFICATION CONTROL**

A dehumidification control accessory 2HU06700124 may be used with variable speed air handlers or furnaces in high humidity areas. This control works with the variable speed indoor unit to provide cooling at a reduced air flow, lowering coil temperature and increasing latent capacity. The humidistat control opens the humidistat contacts on humidity rise. To install, refer to instructions packaged with the accessory. Prior to the installation of the dehumidification control, the HUM STAT jumper on the indoor variable speed air handler or furnace control board must be set to YES.

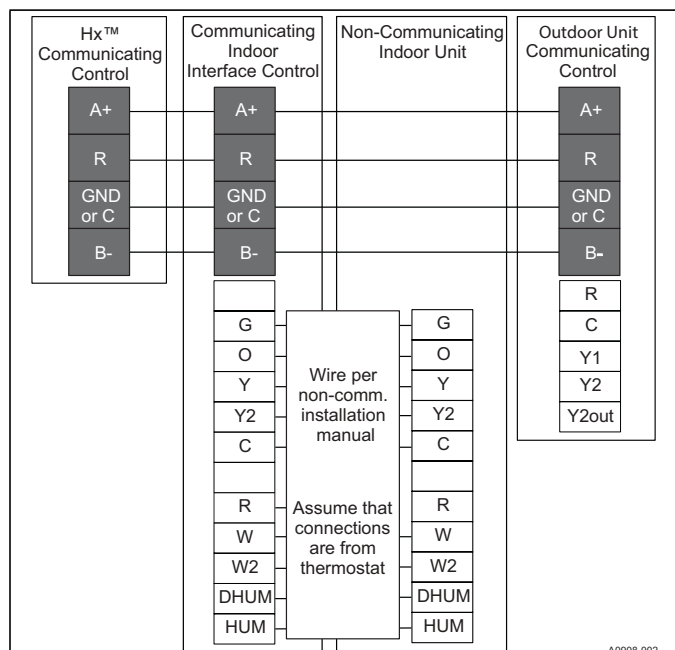
During cooling, if the relative humidity in the space is higher than the desired setpoint of the dehumidification control, the variable speed blower motor will operate at lower speed until the dehumidification control is satisfied. A 40-60% relative humidity level is recommended to achieve optimum comfort.

If a dehumidification control is installed, it is recommended that a minimum air flow of 325 CFM/ton be supplied at all times.

Refer to the Hx3 thermostat installation manual for dehumidification settings. If a dehumidification control is installed, it is recommended that a minimum air flow of 325 cfm/ton be supplied at all times.



**FIGURE 13:** Communicating HP with Communicating Air Handler or Furnace

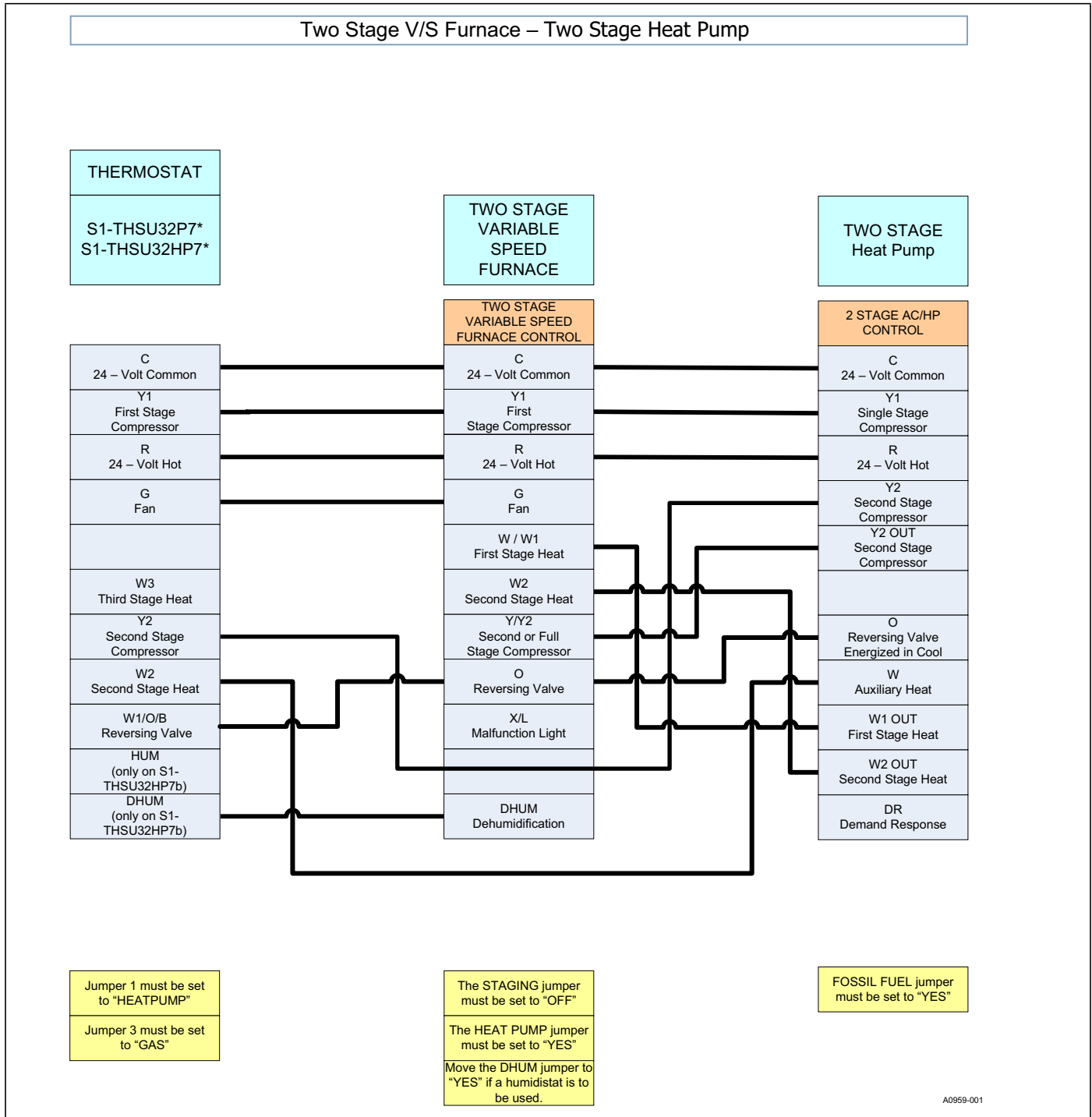


**FIGURE 14:** Communicating HP with Non-Communicating Air Handler or Furnace using Communicating Interface Control

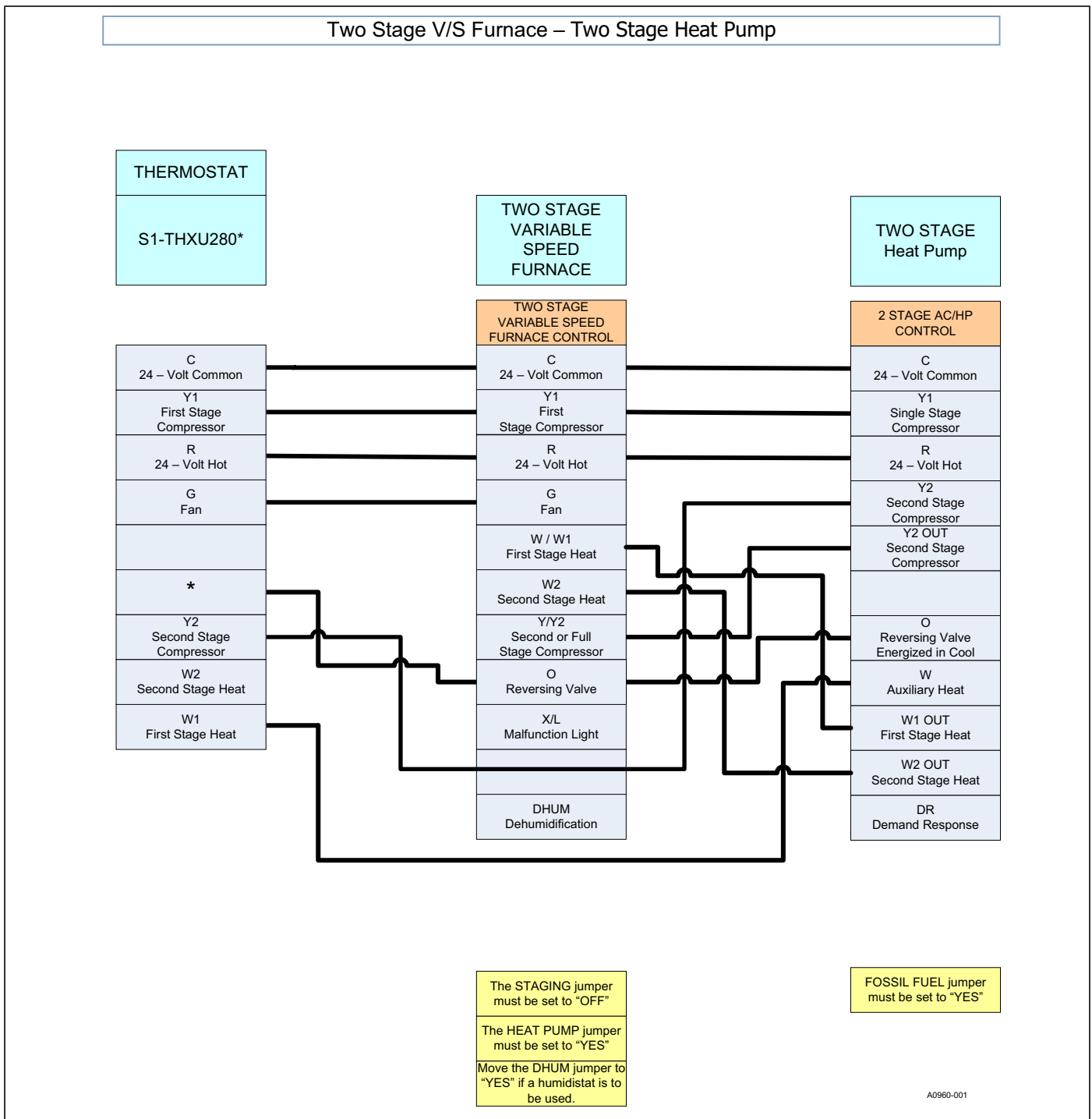
**INDOOR CFM CONFIGURATION**

For proper system operation the indoor CFM must be set correctly. The recommended airflow settings for each outdoor unit's size and associated match can be found in the Outdoor Unit Technical Guide. Manually setting the airflow on the Indoor Control is required with the Hx™ Communicating thermostat. Set the cooling speed per the instructions, defined in the air handler or furnace. Verify the airflow after the configuration has been set on the Indoor Control.

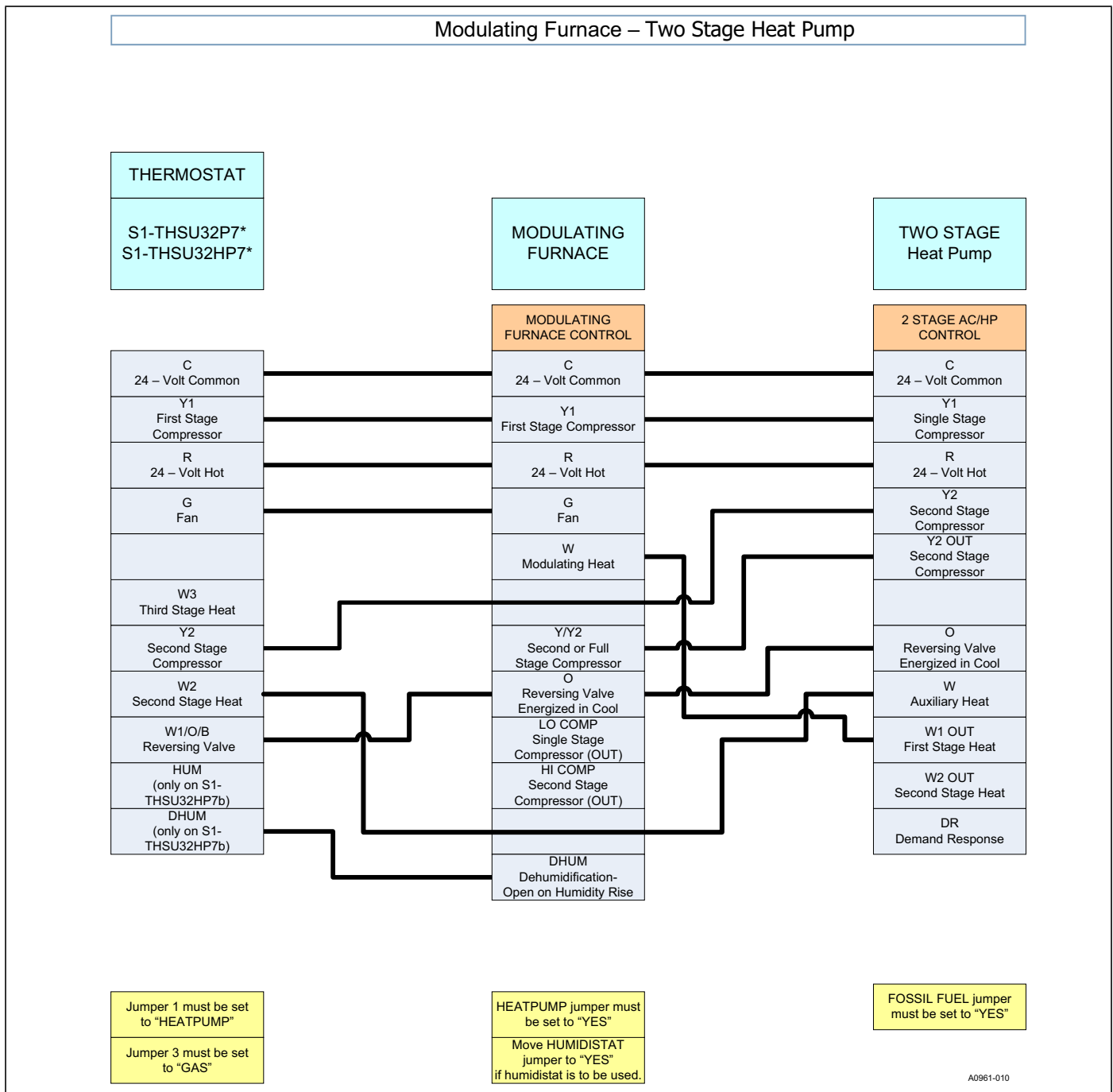
For additional connection diagrams for all UPG equipment refer to "Low Voltage System Wiring" document available online at www.upgnet.com in the Product Catalog Section.



**FIGURE 15:** Thermostat Chart for Two Stage V/S Furnace – Two Stage Heat Pump

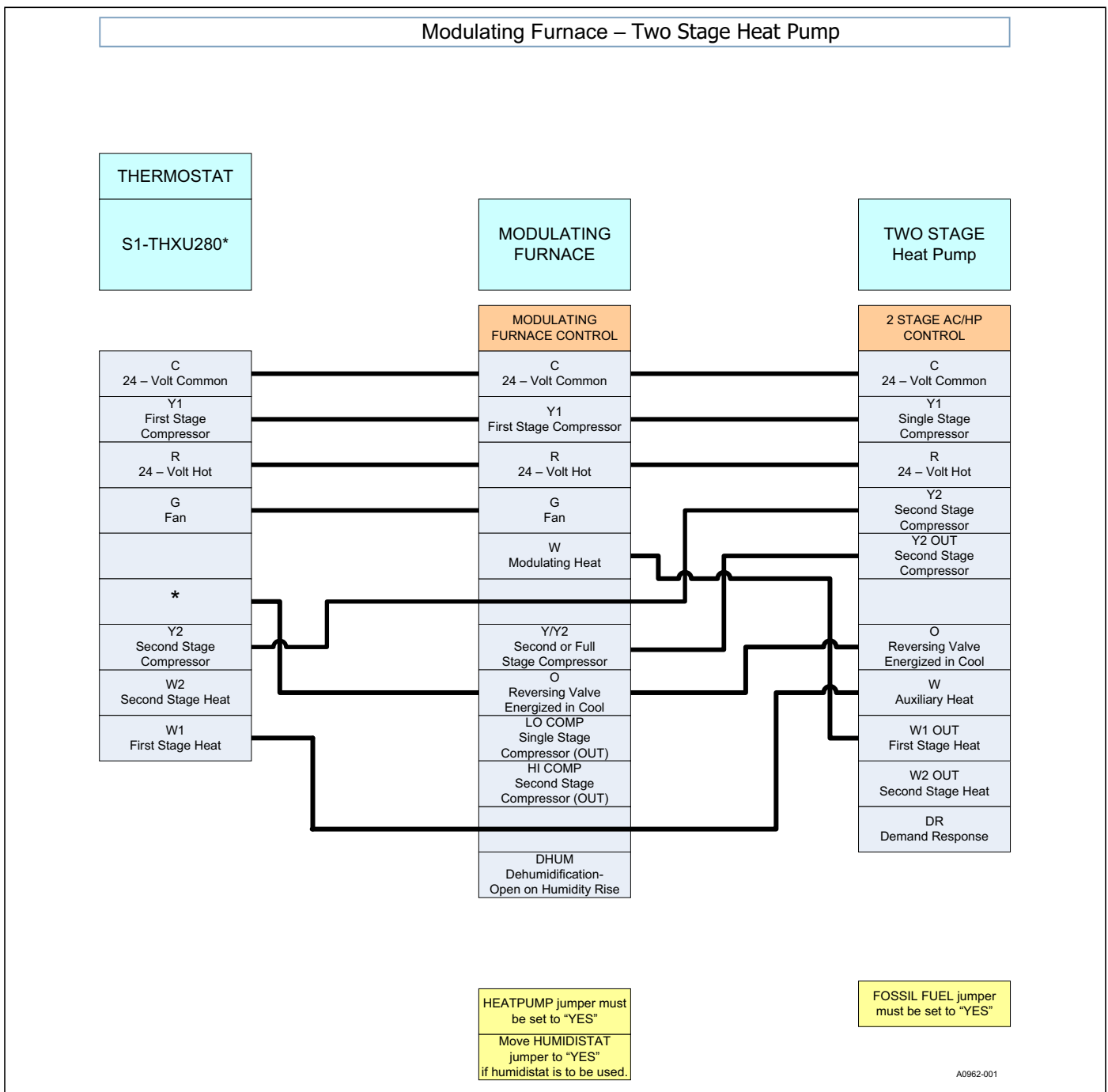


**FIGURE 16:** Thermostat Chart for Two Stage V/S Furnace – Two Stage Heat Pump

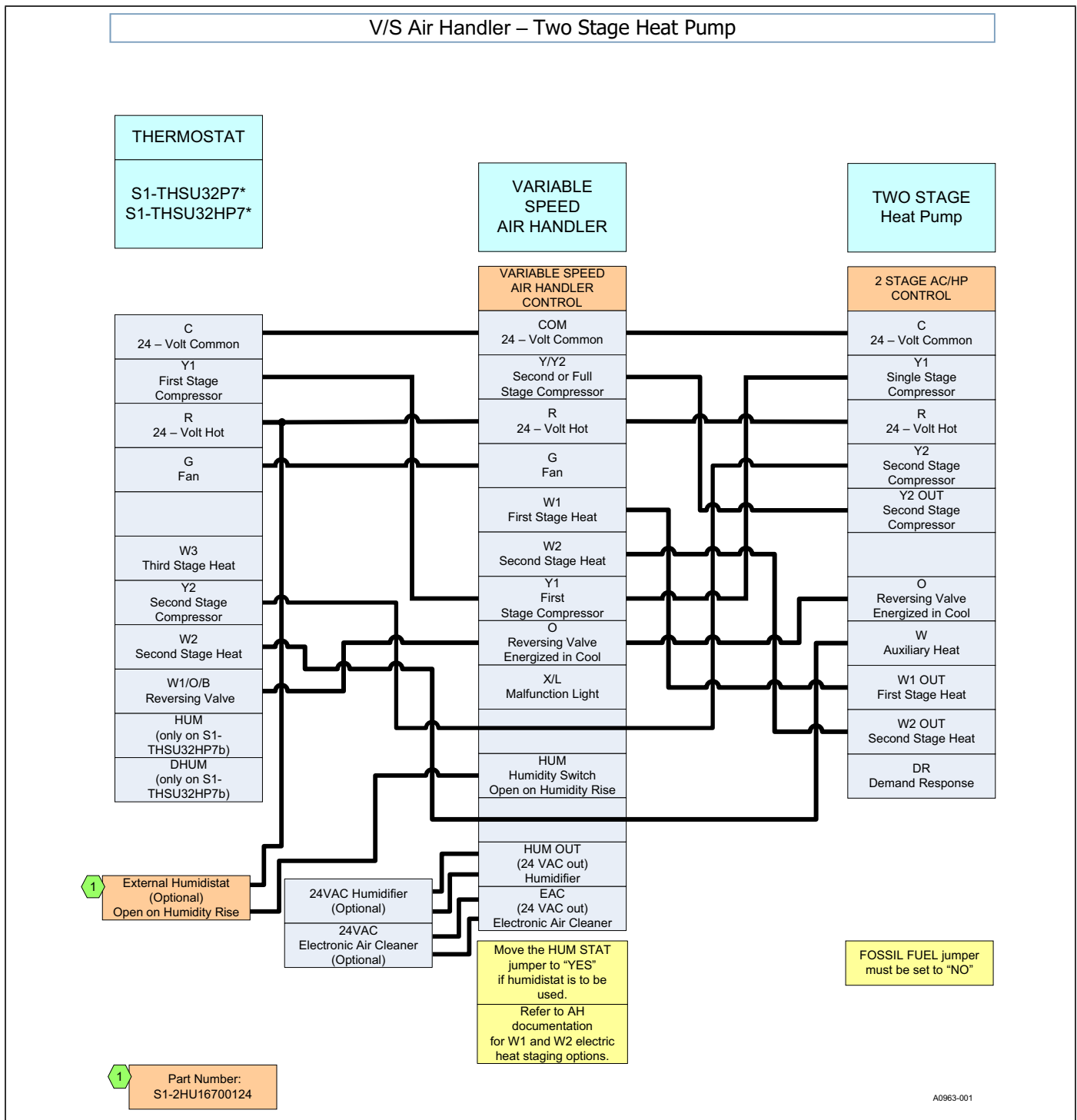


**FIGURE 17:** Thermostat Chart for Modulating Furnace – Two Stage Heat Pump





**FIGURE 18:** Thermostat Chart for Modulating Furnace – Two Stage Heat Pump



**FIGURE 19:** Thermostat Chart for V/S Air Handler – Two Stage Heat Pump

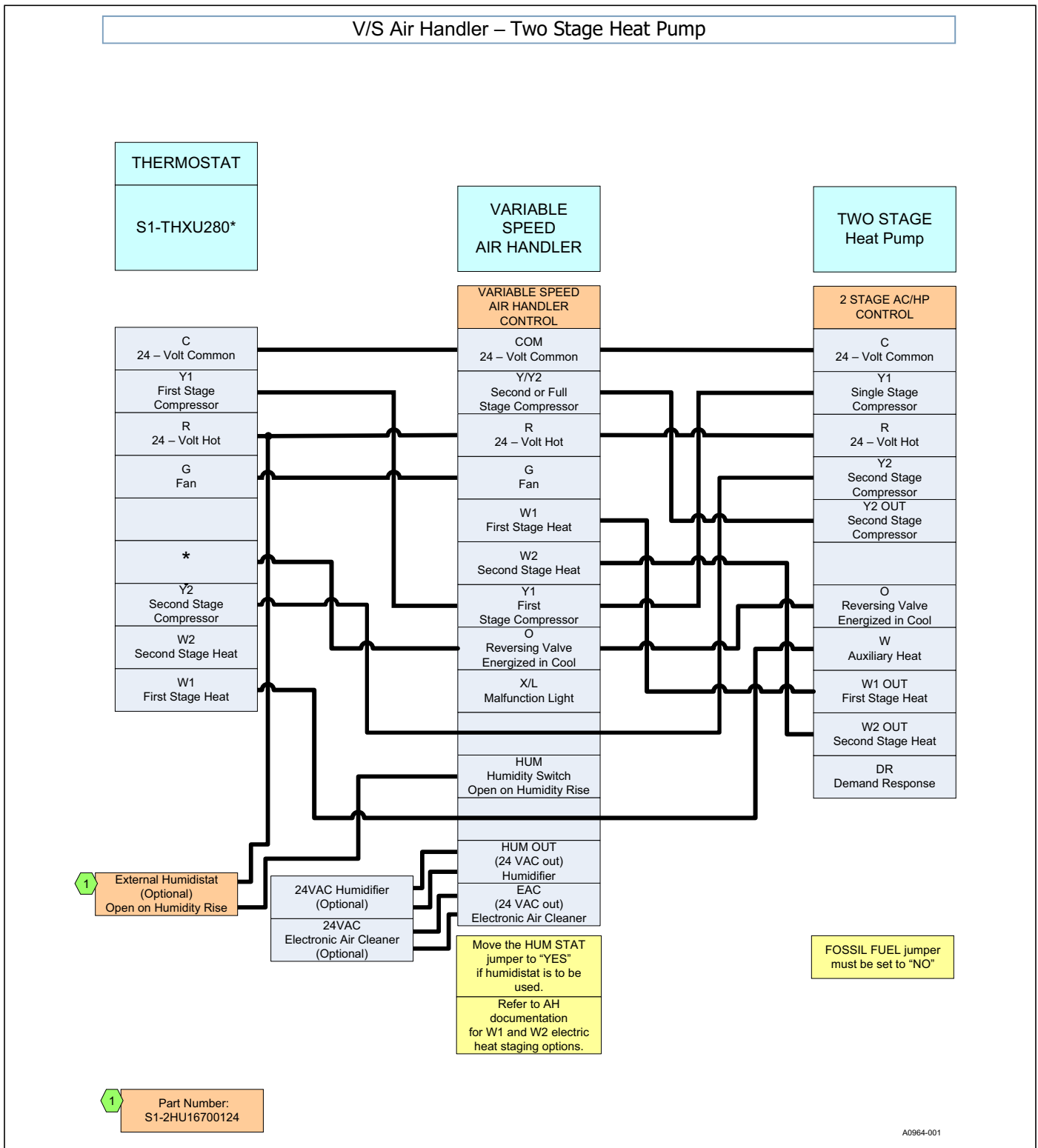


FIGURE 20: Thermostat Chart for V/S Air Handler – Two Stage Heat Pump

## FAULT AND STATUS CODE BEHAVIOR

### Fault Code Storage

The control stores the ten most recent fault codes in memory, for review by the service technician. The codes are stored even when power is removed from the control and will remain in memory until manually cleared from the control. All codes are time stamped and stored in order of occurrence.

The control has a status LED and two 7-segment displays. The control will provide STATUS codes indicating the state of the system using the status LED and 7-segments display, as detailed in Table 5.

A red LED indicates that a system fault is present. Fault details can be found in Table 20.

### Status Code Display

The control has a status LED and two 7-segment displays. The control will provide STATUS codes indicating the state of the system using the status LED and 7-segments, as detailed in Table 18.

### Fault Code Display

Stored faults can be displayed by pressing the PUSH BUTTON for greater than two but less than six seconds, while no thermostat inputs to the control are energized. Since some room thermostats energize the O signal even when not calling for compressor operation, turn the room thermostat to the SYSTEM OFF position.

If faults are present during an active call for compressor operation (thermostat input present to the control), the control will display all active faults in a loop sequence. Please see the below example:

**Example:** If a "High Discharge Temperature" (15) and "Discharge Temperature Sensor Failure - Short" (13) are active at the same time the control display will indicate the below pattern:

15 - two sec. off - 13 - two sec. off - 15 - two sec. off - 13 - two sec. off - 15... (loop continues).

In the above illustration, if the "Discharge Temperature Sensor Failure - Short" fault is no longer present, the display will indicate the below pattern:

15 - two sec. off - 15 - two sec. off - 15... (loop continues)

Finally, if the "High Discharge Temperature" fault is no longer present, the control will return to normal operation.

### Clear Fault Codes

Pressing the PUSH BUTTON, with no active call, longer than six seconds will clear all none active faults. This operation will reset both control timers and counters.

### PWM Display

Pressing the PUSH BUTTON, with a compressor call, less than two seconds, will display the PWM being sent to the outdoor fan.

### Configuration Display

Pressing the PUSH BUTTON, with no active call, less than two seconds, will display the current mode.

Pressing the PUSH BUTTON, with no active call, longer than six seconds, will display the current mode and tonnage..

- AC / HP is determined by the presence of the reversing valve.

### Anti-Short Cycle Delay (ASCD)

After the tonnage is set, a call may be given Y and/or Y/Y2. The control has a 5 minute anti-short cycle delay. It will count the minutes down on the control as **d5, d4, d3, d2, & d1**. The timer may be bypassed by pressing the PUSH BUTTON between two to six seconds.

The control will then show an active call as:

- C1 = 1st stage cooling, C2 = 2nd stage cooling
- H1 = 1st stage heating, H2 = 2nd stage heating

### Set Tonnage (Clearing error code 30)

The control is designed to be programmed in the factory with model and tonnage. Repair part controls have not been programmed in the factory. If the Hx™ thermostat was on the system with the previous control configurations, it will program the replacement controls tonnage.

## NOTICE

*If a restore defaults is performed on the Hx™ thermostat or the installation is a conventional install, manual configuration of the model and tonnage is required.*

When power is applied to a non-configured control it will show **0t**, the tonnage has not been set. The control will then show **30**, tonnage configuration error code.

For conventional configuration set the dipswitches as follows:



When the dipswitches are set, hold the PUSH BUTTON, longer than six seconds without a call for compressor. The new tonnage will be displayed. If the proper tonnage is not displayed, correct the dipswitch setting and hold the PUSH BUTTON again. It is not necessary to cycle power.

If tonnage is set both by dipswitches and by the Hx™ thermostat, the last change will be saved.

AC/HP status is hardcoded into the control. Periodically, the control will run a check to verify the presence of a reversing valve. If the control senses a change in this status, it will produce an error code. Pressing the PUSH BUTTON for greater than six seconds, is required. AC/HP configuration will be written to the control and displayed on the 7-segment displays.

TABLE 17: Status Codes

Description	Status LED	Color	7-Segment Display 1	7-Segment Display 2
No power to control	OFF	OFF	–	–
Control normal operation – no call for compressor (Standby Mode)	2s ON / 2s OFF (“Heartbeat”)	Green	–	–
Control normal operation – in ASCD period (COOLING)	0.1 sec ON / 0.1 sec OFF	Green	d	5,4,3,2,1
Control normal operation – in ASCD period (HEATING)	0.1 sec ON / 0.1 sec OFF	Amber	d	5,4,3,2,1
Control normal operation – call for first-stage cooling compressor	ON	Green	C	1
Control normal operation – call for second-stage cooling compressor	ON	Green	C	2
Control normal operation – call for first-stage heating compressor	ON	Amber	H	1
Control normal operation – call for second-stage heating compressor or Aux heat above BP	ON	Amber	H	2
Auxiliary Heat 1 (below BP)	ON	Amber	A	1
Auxiliary Heat 2 (below BP)	ON	Amber	A	2
Demand Response	Active (Cooling)	Green	d	r
Demand Response	Active (Heating)	Amber	d	r
Any Fault code that would prevent the equipment from running	See Fault Codes	See Fault Codes	–	–
No fault codes in memory	2 flashes	Green	–	–
Fault code memory cleared	3 flashes	Green	–	–
Stage 1 Emergency Heat (W without Y)	ON	Amber	E	1
Stage 2 (W + 16 minutes without Y) Emergency Heat	ON	Amber	E	2
Oil Return	ON	Amber	o	r
Defrost, Demand	ON	Amber	d	d
Defrost, Calibration	ON	Amber	d	c
Defrost, Time Temp	ON	Amber	t	d
Defrost, Forced	ON	Amber	F	d

TABLE 18: Status Code Display &amp; Timing

Duration of connection (seconds)	Control behavior with no thermostat signals present	Control behavior with thermostat signals present <sup>1</sup>
< 2	Display Operational Mode (AC or HP) (5 sec)	Display PWM sent to the ODF (5 sec)
2-6	Display Current/Stored Fault Code(s) if present	Bypass ASCD (Reduce timer to zero immediately).
	<b>Note:</b> If a fault condition is active, the control will continue to display the active fault. It will not display stored faults until the active fault is cleared.	If Y1 is present and high-pressure switch is closed, contactors will be energized.
	Clear soft lockout	Clear soft lockout; <b>Except</b> Fault Codes 25, 26, and 30.
	Clear hard lockout	Clear hard lockout; <b>Except</b> Fault Codes 25, 26, and 30.
> 6	Set Tonnage Configuration (5 sec), ONLY if the Tonnage Configuration Error fault is currently active.	Initiate a force defrost cycle if the coil temp is less than the terminate temp or until an O signal is energized.
	Set Operational Mode (AC or HP) (5 sec), ONLY if the AC/HP Mode fault is currently active.	Terminate defrost normally, if the coil temp is greater than the terminate temp or until an O signal is energized.
	<b>Note:</b> If either of the previous 2 actions were taken, the following will <b>not</b> occur on the same PUSH BUTTON press.	De-energize defrost mode flash code display on 7 segment display (HP only).
	Clear Fault Code Array, if faults are present	
	Clear soft lockout	Clear soft lockout; <b>Except</b> Fault Codes 25, 26, and 30.
	Clear hard lockout	Clear hard lockout; <b>Except</b> Fault Codes 25, 26, and 30.
Pushbutton signal removed	Resume normal LED display	Resume normal LED display
Pushbutton signal not removed	Display will toggle between Operational Mode (AC/HP) (5 sec) and Tonnage Configuration (5 sec)	Resume normal LED display

1. If the PUSH BUTTON is pressed during second-stage anticipation mode, with an active thermostat call. The control will remove the forced second stage.

TABLE 19: Fault Codes

Description	Required Condition	LED	7-Segment Display 1	7-Segment Display 2	Control Response
<b>Control Fault</b>					
Control Failure	Control failure occurs and can be detected.	RED (solid)	0	0	Notify of failure if possible
<b>Operational Faults</b>					
High-pressure switch fault (not in lockout yet)	HPS Opening	RED (solid)	0	1	Fault
System in high-pressure switch lockout (last mode of operation was normal compressor)	HPS Openings: 2 HPS faults within 6 hours	2 RED flashes	0	2	Soft Lockout
System in high-pressure switch lockout (last mode of operation was normal compressor)	HPS Openings: 4 HPS soft lockouts within 12 hours or a combination of 4 soft lockouts	3 RED flashes	0	2	Hard Lockout
*System in high-pressure switch lockout (last mode of operation was defrost)	2 HPS faults within 6 hours	2 RED flashes	0	3	Soft Lockout
*System in high-pressure switch lockout (last mode of operation was defrost)	4 HPS soft lockouts within 12 hours	3 RED flashes	0	3	Hard Lockout
Low-pressure switch fault	LPS open > 5 seconds 1 fault occurrence	2 RED flashes	0	4	Soft Lockout
Low-pressure switch fault	LPS open > 5 seconds, 4 LPS soft lockouts within 12 hours	3 RED flashes	0	4	Hard Lockout
Cooling LTCO Active	Call for cooling below 35°F	RED (solid)	0	5	Fault, None Lockout
Low Voltage (<19.2VAC) preventing further relay outputs for > 2 seconds	Further calls for relay outputs prevented based on low voltage	RED (solid)	0	6	Fault, None Lockout
Low Voltage (<16 VAC) stopped current relay outputs for > 2 seconds	Relay outputs stopped based on low voltage	RED (solid)	0	7	Fault, None Lockout
*Pipe Freeze Timer expiration	Pipe Freeze Timer expiration	RED (solid)	0	8	See other section
<b>Required Sensor or Switch Faults</b>					
Outdoor ambient sensor failure in cooling mode (short)	Control senses a shorted sensor	RED (solid)	0	9	ODF pwm to max per tonnage and call
Outdoor ambient sensor failure in cooling mode (open)	Control senses an opened sensor	RED (solid)	1	0	ODF pwm to max per tonnage and call
*Outdoor ambient sensor failure in heating mode (short)	Control senses a shorted sensor	RED (solid)	0	9	Fault, None lockout
*Outdoor ambient sensor failure in heating mode (short)	Control senses a shorted sensor	2 RED flashes	0	9	Soft Lockout
*Outdoor ambient sensor failure in heating mode (open)	Control senses an opened sensor	RED (solid)	1	0	Fault, None lockout
*Outdoor ambient sensor failure in heating mode (open)	Control senses an opened sensor	2 RED flashes	1	0	Soft Lockout
*Coil (liquid line) sensor failure (short)	Control senses a shorted sensor	2 RED flashes	1	1	Soft Lockout if in heat pump mode
*Coil (liquid line) sensor failure (open)	Control senses an opened sensor	2 RED flashes	1	2	Soft Lockout if in heat pump mode
Discharge line sensor failure (short)	Control senses a shorted sensor	2 RED flashes	1	3	Soft Lockout
Discharge line sensor failure (open)	Control senses an opened sensor	2 RED flashes	1	4	Soft Lockout
High discharge line temperature	Discharge Temperature Sensor is > 263 ℉	RED (solid)	1	5	Fault, None lockout
High discharge line temperature	Discharge Temperature Sensor is > 263 ℉	2 RED flashes	1	5	Soft Lockout
High discharge line temperature	Discharge Temperature Sensor is > 263 ℉	3 RED flashes	1	5	Hard Lockout
Low discharge line temperature	Discharge Temperature Sensor is < 90 ℉	RED (solid)	1	6	Fault, None lockout
Low discharge line temperature	Discharge Temperature Sensor is < 90 ℉	2 RED flashes	1	6	Soft Lockout
Low discharge line temperature	Discharge Temperature Sensor is < 90 ℉	3 RED flashes	1	6	Hard Lockout
*Bonnet sensor failure (short)	Control senses a shorted sensor	2 RED flashes	1	7	Soft Lockout

Continued on next page.

TABLE 19: Fault Codes (Continued)

Description	Required Condition	LED	7-Segment Display 1	7-Segment Display 2	Control Response
<b>Wiring Related Faults</b>					
O signal received in AC mode	O signal received in AC mode	2 RED flashes	1	8	Soft Lockout
W signal received in AC mode	W signal received in AC mode	2 RED flashes	1	9	Soft Lockout
W and O signal received in AC mode	W and O signal received in AC mode	2 RED flashes	2	0	Soft Lockout
W and O signal received in HP mode	W and O signal received in HP mode	2 RED flashes	2	4	Soft Lockout
System previously configured as AC, now HP	No RV on configuration, RV present on subsequent startup	2 RED flashes	2	5	Heat Pump Heating, Soft Lockout Cooling
System previously configured as HP, now AC	RV present on configuration, No RV on subsequent startup	RED (solid)	2	6	Normal Heating, Aux Heat, E-heat will remain active for the duration of a call requiring a Defrost cycle
System previously configured as HP, now AC	RV present on configuration, No RV on subsequent startup	2 RED flashes	2	6	Soft Lockout, Cooling ONLY
Y2 present without Y1	Y2 present without Y1	2 RED flashes	2	7	Soft Lockout
*Fossil Fuel Mode setting error	Fossil Fuel jumper in OFF position but bonnet sensor present	RED (solid)	2	8	Operate in fossil fuel mode
<b>Configuration Error</b>					
Configuration Error	Jumpers @ 000 with no factory setting loaded and no tonnage selected, 1 fault occurrence	2 RED flashes	3	0	Soft Lockout

## SECTION VIII: INSTRUCTING THE OWNER

Assist the owner with registering the unit warranty using the warranty card included with the unit, or preferably online at [www.upgproductregistration.com](http://www.upgproductregistration.com). It is strongly recommended to complete a startup sheet showing the critical readings of the unit at the time of commissioning, which can be uploaded as part of the online registration process.

When applicable, instruct the owner that the compressor is equipped with a crankcase heater to prevent the migration of refrigerant to the compressor during the OFF cycle. The heater is energized when the ambient temperature is below 55°F for 30 seconds continually and the compressor has been off for 31 minutes. The heater will cycle ON for 10 minutes and OFF for 10 minutes, until the outdoor ambient is above 55°F for 30 seconds continually, or an active demand for compressor operation occurs. If the unit power supply is disconnected for long periods of time, do not attempt to start the unit until power has been applied for a minimum of 2 hours. This will allow sufficient time for all liquid refrigerant to be driven out of the compressor.

The installer should also instruct the owner on proper operation and maintenance of all other system components.

### OUTDOOR FAN OPERATION

The outdoor fan motor varies the outdoor fan RPM based on algorithms within the control board software. This means that the fan motor could change speed as required at any moment depending on conditions and compressor stage. Do not be alarmed as this is normal operation. If the conditions are on a break over point, the motor could speed up and slow down until a more constant condition is met. Under typical operation, the motor speeds up the warmer it is outside and slows down the cooler it is outside, to maintain highest efficiency and operating pres-

ures as needed. Charging of the equipment with the variable outdoor fan motor is already accounted for in the charging charts for the equipment. Should an outdoor fan motor failure ever occur requiring replacement, the outdoor fan motor must be replaced with the original OEM part number through Source 1. Refer to unit repair parts list to find the appropriate replacement part number.

### MAINTENANCE

1. Dirt should not be allowed to accumulate on the outdoor coils or other parts in the air circuit. Clean as often as necessary to keep the unit clean. Use a brush, vacuum cleaner attachment, or other suitable means.
2. The outdoor fan motor bearings are permanently lubricated and do not require periodic oiling.
3. If the coil needs to be cleaned, it should be washed with water or a PH neutral detergent. Allow solution to remain on coil for several minutes before rinsing with clean water. Solution should not be permitted to come in contact with painted surfaces.
4. Refer to the furnace or air handler instructions for filter and blower motor maintenance.
5. The indoor coil and drain pan should be inspected and cleaned regularly to prevent odors and assure proper drainage.

## CAUTION

*It is unlawful to knowingly vent, release or discharge refrigerant into the open air during repair, service, maintenance or the final disposal of this unit.*

**THE COOLING CHARGE TABLE IS ON THE UNIT CODE PLATE ATTACHED TO THE OUTSIDE OF THE CONTROL BOX COVER.**

SECTION IX: WIRING DIAGRAM

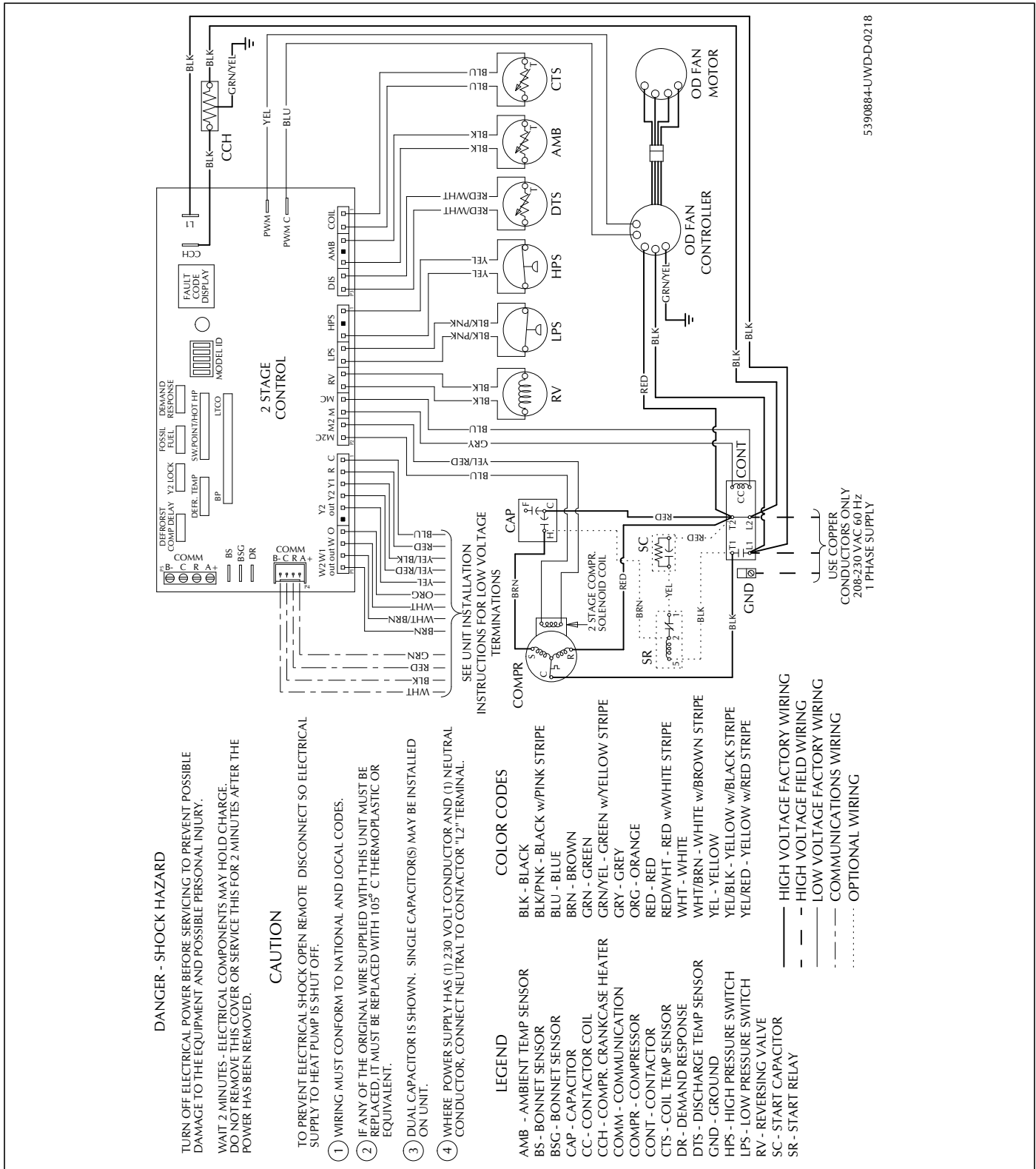


FIGURE 21: Wiring Diagram



## SECTION X: START UP SHEET

## Residential Split 2-Stage Capacity System Unit Cooling With Electric Heat Start-Up Sheet

Proper start-up is critical to customer comfort and equipment longevity

Start-Up Date	<input type="text"/>	Company Name	<input type="text"/>	Start-Up Technician	<input type="text"/>
Dealer Training Certification Number		<input type="text"/>			

**Owner Information**

Name	<input type="text"/>	Address	<input type="text"/>	Daytime Phone	<input type="text"/>
City	<input type="text"/>	State or Province	<input type="text"/>	Zip or Postal Code	<input type="text"/>

**Equipment Data**

Outdoor Model #	<input type="text"/>	Unit Serial #	<input type="text"/>
Indoor Coil/Air Handler Model #	<input type="text"/>	Unit Serial #	<input type="text"/>
Furnace Model #	<input type="text"/>	Unit Serial #	<input type="text"/>
Thermostat #	<input type="text"/>	Unit Serial #	<input type="text"/>

**General Information** (Check all that apply)

<input type="radio"/> New Construction	<input type="radio"/> Roof level	<input type="radio"/> Down flow	<input type="radio"/> Horizontal
<input type="radio"/> Retrofit	<input type="radio"/> Grade level	<input type="radio"/> Upflow	

**Unit Location and Connections** (Check all that apply)

<input type="checkbox"/> Unit is level and installed on:	<input type="checkbox"/> Slab	<input type="checkbox"/> Roof curb	<input type="checkbox"/> Duct connections are complete:	<input type="checkbox"/> Supply	<input type="checkbox"/> Return
<input type="checkbox"/> Condensate drain properly connected per the installation instructions	<input type="checkbox"/> Condensate trap has been primed with water				

**Filters**

<input type="checkbox"/> Filters installed	Number of filters	<input type="text"/>	Filter size	<input type="text"/>
--	-------------------	----------------------	-------------	----------------------

**Electrical Connections & Inspection** (Check all that apply)

<input type="radio"/> 208 volts AC	<input type="radio"/> 230 volt AC						
<input type="checkbox"/> Inspect wires and electrical connections	<input type="checkbox"/> Transformer wired properly for primary supply voltage	<input type="checkbox"/> Ground connected					
<input type="checkbox"/> Low voltage present at control board "R & C"	Measured voltage "R" and "C" outdoor unit control board	<input type="text"/>					
<input type="checkbox"/> Line voltage present at disconnect	Measured voltage "L1 to L2"	<input type="text"/>					
Compressor amperes "L1"	<input type="text"/>	"L2"	<input type="text"/>	Total amperes "L1"	<input type="text"/>	"L2"	<input type="text"/>

**Air Flow Setup / Cooling**

Blower Type & Set-Up	<input type="radio"/> ECM	COOL	<input type="radio"/> A	<input type="radio"/> B	<input type="radio"/> C	<input type="radio"/> D
		ADJUST	<input type="radio"/> A	<input type="radio"/> B	<input type="radio"/> C	<input type="radio"/> D
		DELAY	<input type="radio"/> A	<input type="radio"/> B	<input type="radio"/> C	<input type="radio"/> D
Supply static (inches of water column)	<input type="text"/>	Supply air dry bulb temperature	<input type="text"/>	Supply air wet bulb temperature	<input type="text"/>	
Return static (inches of water column)	<input type="text"/>	Return air dry bulb temperature	<input type="text"/>	Return air wet bulb temperature	<input type="text"/>	
Total external static pressure	<input type="text"/>	Temperature drop	<input type="text"/>	Outside air dry bulb temperature	<input type="text"/>	

Page 1 of 2 (9/27/17)

