

PLA-A24EA7 & PUY-A24NHA7(-BS)
24,000 BTU/H 3' X 3' CEILING CASSETTE
24,000 BTU/H COOLING ONLY OUTDOOR



Job Name:

System Reference:

Date:



Indoor Unit.....PLA-A24EA7

Outdoor Unit

Standard Model.....PUY-A24NHA7

Seacoast Model.....PUY-A24NHA7-BS

INDOOR UNIT FEATURES

- Space-efficient ductless installation
- Equipped with 3D i-see Sensor® for enhanced comfort and energy efficiency
- Airflow settings for high and low ceiling applications
- Individual vane settings for direct/indirect airflow control or variable airflow patterns
- Knockouts for outside-air intake and branch-duct run
- Filter indicator signal
- Easy-to-clean, washable filter (optional high-efficiency filter available - requires multi-function casement)
- Built-in condensate lift mechanism
- Ideal for retail shops, classrooms, office spaces, conference centers, building lobbies, and more
- Multiple control options available:
 - kumo cloud® smart device app for remote access
 - Third-party interface options
 - Wired or wireless controllers

OUTDOOR UNIT FEATURES

- Variable speed INVERTER-driven compressor
- Power receiver pre-charged with refrigerant volume for piping length up to 70 ft
- Low ambient cooling down to -40°F providing 100% capacity (only for PUY models with wind baffles installed)
- 24-hour continuous operation (cooling mode)
- High pressure protection
- Fast restart due to bypass valve make it ideal for equipment cooling applications, such as data centers
- Superior energy and operational efficiency

SPECIFICATIONS: PLA-A24EA7 & PUY-A24NHA7(-BS)

Cooling at 95°F ¹	Maximum Capacity	BTU/H	24,000
	Rated Capacity	BTU/H	24,000
	Minimum Capacity	BTU/H	10,000
	Maximum Power Input	W	1,670
	Rated Power Input	W	1,670
	Moisture Removal	Pints/h	3.0
	Sensible Heat Factor		0.86
Efficiency	Power Factor	%	94.3/94.3
	SEER		24.2
	EER ¹		14.3
Electrical	ENERGY STAR® Certified		Yes
	Voltage, Phase, Frequency		208/230, 1, 60
	Guaranteed Voltage Range	V AC	198 - 253
	Voltage: Indoor - Outdoor, S1-S2	V AC	208/230
	Voltage: Indoor - Outdoor, S2-S3	V DC	24
	Short-circuit Current Rating [SCCR]	kA	5
	Recommended Fuse/Breaker Size (Outdoor)	A	25
Indoor Unit	Recommended Wire Size [Indoor - Outdoor]	AWG	14
	MCA	A	1.0
	Fan Motor Full Load Amperage	A	0.49
	Fan Motor Output	W	120
	Airflow Rate at Cooling, Dry	CFM	530-640-710-810
	Airflow Rate at Cooling, Wet	CFM	490-600-670-770
	Airflow Rate at Heating, Dry	CFM	530-640-710-810
	Sound Pressure Level [Cooling]	dB[A]	28-30-33-36
	Sound Pressure Level [Heating]	dB[A]	28-30-33-36
	Drain Pipe Size	In. [mm]	1-1/4 [32]
	Condensate Lift Mechanism, Maximum Distance	In. [mm]	33-7/16 [849]
	Coating on Heat Exchanger		—
	External Finish Color		White Munsell 6.4Y 8.9/0.4
	Unit Dimensions	W x D x H: In. [mm]	33-1/16 // 37-13/32 x 33-1/16 // 37-13/32 x 11-3/4 // 1-9/16 [840 // 950 x 840 // 950 x 298 // 40]
	Package Dimensions	W x D x H: In. [mm]	35-9/16 // 39-6/16 x 34-5/16 // 38-3/16 x 16-9/16 // 4-12/16 [903 // 1000 x 871 // 970 x 421 // 121]
	Unit Weight	Lbs. [kg]	56 // 11 [25 // 5]
	Package Weight	Lbs. [kg]	68 [31]
Indoor Unit Operating Temperature Range	Cooling Intake Air Temp [Maximum / Minimum]*	°F	95 DB, 71 WB / 67 DB, 57 WB
	Heating Intake Air Temp [Maximum / Minimum]	°F	80 DB / 70 DB
Outdoor Unit	MCA	A	19.0
	MOCP	A	26
	Fan Motor Full Load Amperage	A	0.4
	Fan Motor Output	W	86
	Airflow Rate	CFM	1940
	Refrigerant Control		LEV
	Defrost Method		Reverse Cycle
	Coating on Heat Exchanger		Blue Fin Coating (BS Model only)
	Sound Pressure Level, Cooling ¹	dB(A)	47
	Compressor Type		INVERTER-driven twin rotary
	Compressor Model		SNB172FVHM1
	Compressor Rated Load Amps	A	7.0
	Compressor Locked Rotor Amps	A	11.0
	Compressor Oil Type // Charge	oz.	FV50S // 23
	External Finish Color		Ivory Munsell 3Y 7.8/1.1
	Base Pan Heater		N/A
	Unit Dimensions	W x D x H: In. [mm]	37-13/32 x 13 (+1-3/16) x 37-1/8 [950 x 330 (+30) x 943]
Package Dimensions	W x D x H: In. [mm]	40-15/16 x 17-11/16 x 40-11/16 [1040 x 450 x 1033]	
Unit Weight	Lbs. [kg]	151 [68]	
Package Weight	Lbs. [kg]	176 [80]	

NOTES:

AHRI Rated Conditions
 (Rated data is determined at a fixed compressor speed)

¹ Cooling (Indoor // Outdoor)	°F	80 DB, 67 WB // 95 DB, 75 WB
² Heating at 47°F (Indoor // Outdoor)	°F	70 DB, 60 WB // 47 DB, 43 WB
³ Heating at 17°F (Indoor // Outdoor)	°F	70 DB, 60 WB // 17 DB, 15 WB

Conditions

⁴ Heating at 5°F (Indoor // Outdoor)	°F	70 DB, 60 WB // 5 DB, 4 WB
⁵ Heating at -4°F (Indoor // Outdoor)	°F	70 DB, 60 WB // -4 DB, -5 WB
⁶ Heating at -5°F (Indoor // Outdoor)	°F	70 DB, 60 WB // -5 DB, -6 WB
⁷ Heating at -13°F (Indoor // Outdoor)	°F	70 DB, 60 WB // -13 DB, -14 WB

*Outdoor Unit Operating Temperature Range (Cooling Air Temp (Maximum / Minimum)):

- Applications should be restricted to comfort cooling only; equipment cooling applications are not recommended for low ambient temperature conditions.
 - » Wind baffles required to operate below 23°F DB in cooling mode.
 - » Cooling-only system with wind baffle: -40°F - 115°F.
 - » Heat pump system with wind baffle: 0°F - 115°F.
 - » Refer to wind baffle documentation for further information.

**Outdoor Unit Operating Temperature Range (Cooling Thermal Lock-out / Re-start Temperatures; Heating Thermal Lock-out / Re-start Temperatures):

- System cuts out in heating mode to avoid thermistor error and automatically restarts at these temperatures.

SEACOAST PROTECTION (-BS MODELS)

- External Outer Panel: Phosphate coating + Acrylic-Enamel coating
- Fan Motor Support: Epoxy resin coating (at edge face)
- Separator Assembly Valve Bed: Epoxy resin coating (at edge face)
- Blue Fin treatment is an anti-corrosion treatment that is applied to the condenser coil to protect it against airborne contaminants.

SPECIFICATIONS: PLA-A24EA7 & PUY-A24NHA7(-BS)

Outdoor Unit Operating Temperature Range	Cooling Air Temp [Maximum / Minimum]*	°F	115 DB / -40 DB
Refrigerant	Type		R410A
	Charge	Lbs, oz	7, 11
	Chargeless Piping Length	Ft. [m]	70.0 [20.0]
	Additional Refrigerant Charge Per Additional Piping Length	oz./Ft. [g/m]	0.3 [22.5]
Piping	Gas Pipe Size O.D. [Flared]	In.[mm]	5/8 [15.88]
	Liquid Pipe Size O.D. [Flared]	In.[mm]	3/8 [9.52]
	Maximum Piping Length	Ft. [m]	225 [68]
	Maximum Height Difference	Ft. [m]	100 [30]
	Maximum Number of Bends		10

NOTES:

AHRI Rated Conditions (Rated data is determined at a fixed compressor speed)	¹ Cooling (Indoor // Outdoor) ² Heating at 47°F (Indoor // Outdoor) ³ Heating at 17°F (Indoor // Outdoor)	°F °F °F	80 DB, 67 WB // 95 DB, 75 WB 70 DB, 60 WB // 47 DB, 43 WB 70 DB, 60 WB // 17 DB, 15 WB
Conditions	⁴ Heating at 5°F (Indoor // Outdoor) ⁵ Heating at -4°F (Indoor // Outdoor) ⁶ Heating at -5°F (Indoor // Outdoor) ⁷ Heating at -13°F (Indoor // Outdoor)	°F °F °F °F	70 DB, 60 WB // 5 DB, 4 WB 70 DB, 60 WB // -4 DB, -5 WB 70 DB, 60 WB // -5 DB, -6 WB 70 DB, 60 WB // -13 DB, -14 WB

*Outdoor Unit Operating Temperature Range (Cooling Air Temp (Maximum / Minimum)):

- Applications should be restricted to comfort cooling only; equipment cooling applications are not recommended for low ambient temperature conditions.
 - » Wind baffles required to operate below 23°F DB in cooling mode.
 - » Cooling-only system with wind baffle: -40°F - 115°F.
 - » Heat pump system with wind baffle: 0°F - 115°F.
 - » Refer to wind baffle documentation for further information.

**Outdoor Unit Operating Temperature Range (Cooling Thermal Lock-out / Re-start Temperatures; Heating Thermal Lock-out / Re-start Temperatures):

- System cuts out in heating mode to avoid thermistor error and automatically restarts at these temperatures.

SEACOAST PROTECTION (-BS MODELS)

- External Outer Panel: Phosphate coating + Acrylic-Enamel coating
- Fan Motor Support: Epoxy resin coating (at edge face)
- Separator Assembly Valve Bed: Epoxy resin coating (at edge face)
- Blue Fin treatment is an anti-corrosion treatment that is applied to the condenser coil to protect it against airborne contaminants.

INDOOR UNIT ACCESSORIES: PLA-A24EA7

Control Interface	3-Pin Connector	<input type="checkbox"/> PAC-715AD
	BACnet® and Modbus Interface	<input type="checkbox"/> PAC-UKPRC001-CN-1
	CN24 Relay Kit	<input type="checkbox"/> CN24RELAY-KIT-CM3
	IT Extender	<input type="checkbox"/> PAC-WHS01IE-E
	kumo station® for kumo cloud®	<input type="checkbox"/> PAC-WHS01HC-E
	Lockdown bracket for remote controller	<input type="checkbox"/> RCMKP1CB
	Remote Operation Adapter†	<input type="checkbox"/> PAC-SF40RM-E
	Thermostat Interface	<input type="checkbox"/> PAC-US444CN-1
	USNAP Adapter	<input type="checkbox"/> PAC-WHS01UP-E
	Wireless Interface for kumo cloud®	<input type="checkbox"/> PAC-USWHS002-WF-2
Remote Sensor	Flush Mount Temperature Sensor	<input type="checkbox"/> PAC-USSEN001-FM-1
	Remote Temperature Sensor surface mount	<input type="checkbox"/> PAC-SE41TS-E
	Wireless temperature and humidity sensor for kumo cloud®	<input type="checkbox"/> PAC-USWHS003-TH-1
Wired Remote Controller	Deluxe Wired MA Remote Controller†	<input type="checkbox"/> PAR-40MAAU
	Simple MA Remote Controller†	<input type="checkbox"/> PAC-YT53CRAU-J
	Touch MA Controller†	<input type="checkbox"/> PAR-CT01MAU-SB
Wireless Remote Controller	kumo touch™ RedLINK™ Wireless Controller	<input type="checkbox"/> MHK2
	Wireless Remote Controller	<input type="checkbox"/> PAR-SL100A-E
	Wireless Signal Receiver Panel	<input type="checkbox"/> PAR-SR4LU-E
Casement	Multi-function Casement	<input type="checkbox"/> PAC-SJ41TM-E
Condensate	Blue Diamond (Advanced) Mini Condensate Pump w/ Reservoir & Sensor (208/230V) [recommended]	<input type="checkbox"/> X87-721
	Blue Diamond (MegaBlue Advanced) Condensate Pump w/ Reservoir & Sensor	<input type="checkbox"/> X87-835
	Blue Diamond Sensor Extension Cable — 15 Ft.	<input type="checkbox"/> C13-103
Disconnect Switch	(30A/600V/UL) [fits 2" X 4" utility box] - Black	<input type="checkbox"/> TAZ-MS303
	(30A/600V/UL) [fits 2" X 4" utility box] - White	<input type="checkbox"/> TAZ-MS303W
Filter	High Efficiency Filter Element	<input type="checkbox"/> PAC-SH59KF-E
Lineset	10' x 3/8" x 10' x 5/8" Lineset (Twin-Tube Insulation)	<input type="checkbox"/> MPLS385812T-10
	100' x 3/8" x 100' x 5/8" Lineset (Twin-Tube Insulation)	<input type="checkbox"/> MPLS385812T-100
	15' x 3/8" x 15' x 5/8" Lineset (Twin-Tube Insulation)	<input type="checkbox"/> MPLS385812T-15
	30' x 3/8" x 30' x 5/8" Lineset (Twin-Tube Insulation)	<input type="checkbox"/> MPLS385812T-30
	50' x 3/8" x 50' x 5/8" Lineset (Twin-Tube Insulation)	<input type="checkbox"/> MPLS385812T-50
	65' x 3/8" x 65' x 5/8" Lineset (Twin-Tube Insulation)	<input type="checkbox"/> MPLS385812T-65
Shutter Plate	Drain Pan	<input type="checkbox"/> PAC-SJ37SP-E
Space Panel	Architectural Surround for Ceiling Recessed Units	<input type="checkbox"/> PLFY-ITP1
	Space Panel	<input type="checkbox"/> PAC-SJ38AS-E

NOTES:

*PAC-SF40RM-E (Unable to use with wireless remote controller)
 • Ceiling Cassette, Ceiling Suspended, Horizontal-ducted and Multi-position Air Handler

OUTDOOR UNIT ACCESSORIES: PUY-A24NHA7(-BS)

Air Outlet Guide	Air Outlet Guide (1 Piece)	<input type="checkbox"/> PAC-SG59SG-E
Centralized Drain Pan	Drain Pan	<input type="checkbox"/> PAC-SG64DP-E
Control/Service Tool	Control/Service Tool	<input type="checkbox"/> PAC-SK52ST
	M- & P-Series Maintenance Tool Cable Set	<input type="checkbox"/> M21EC0397
	USB/UART Conversion Cable (Required for all laptop connection)	<input type="checkbox"/> M21EC1397
Distribution pipe	Twinning Distribution Pipe (50:50)	<input type="checkbox"/> MSDD-50TR-E
Drain Socket	Drain Socket	<input type="checkbox"/> PAC-SG61DS-E
Hail Guards	Hail Guard	<input type="checkbox"/> HG-A6
M-NET Converter	M-NET Converter	<input type="checkbox"/> PAC-SJ85MA-E
	M-NET Converter	<input type="checkbox"/> PAC-SJ95MA-E
Mini-Split Wire	14 Gauge, 4 wire MiniSplit Cable—250 ft. roll	<input type="checkbox"/> S144-250
	14 Gauge, 4 wire MiniSplit Cable—50 ft. roll	<input type="checkbox"/> S144-50
	16 Gauge, 4 wire MiniSplit Cable—250 ft. roll	<input type="checkbox"/> S164-250
	16 Gauge, 4 wire MiniSplit Cable—50 ft. roll	<input type="checkbox"/> S164-50
Mounting Pad	Condensing Unit Mounting Pad: 24" x 42" x 3"	<input type="checkbox"/> ULTRILITE2
Stand	18" Single Fan Stand	<input type="checkbox"/> QSMS1801M
	24" Single Fan Stand	<input type="checkbox"/> QSMS2401M
	Condenser Wall Bracket	<input type="checkbox"/> QSWB2000M-1
	Condenser Wall Bracket -Stainless Steel Finish	<input type="checkbox"/> QSWBSS
	Outdoor Unit Stand — 12" High	<input type="checkbox"/> QSMS1201M
Wind Baffle	Front Wind Baffle	<input type="checkbox"/> WB-PA5
	Rear Wind Baffle	<input type="checkbox"/> WB-RE5
	Side Advanced Wind Baffle	<input type="checkbox"/> WB-SD5

INDOOR UNIT DIMENSIONS: PLA-A24EA7

Unit: inch (mm)

- 1) CHOOSE THE GRILLE AMONG THE DESIGNATED GRILLES.
- 2) REINFORCE THE SUSPENSION BOLT FOR EARTHQUAKE RESISTANCE AS NEEDED.
- 3) PROCEED AT THE LOCAL SITE.
- 4) FOR DRAIN PIPE, USE W-2410, H-1411, 20" PVC TUBE.
- 5) DRAIN IS MADE AS A CONNECTION FROM THE CEILING.
- 6) ELECTRICAL BOX MAY BE REMOVED FOR THE SERVICE PURPOSE.
- 7) REQUIRE "E" OR MORE SPACE BETWEEN RANSOM AND CEILING FOR THE INSTALLATION.
- 8) WHEN INSTALLING THE BRANCH DUCTS, BE SURE TO INSULATE ADEQUATELY.
- 9) AS FOR NECESSARY INSTALLATION SERVICE SPACE, PLEASE REFER TO THE MULTIFUNCTIONAL CASEMENT REFER TO SPECIAL DRAWING.

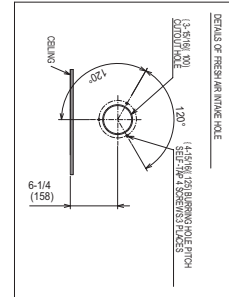
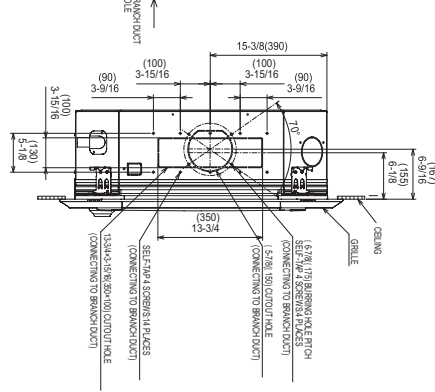
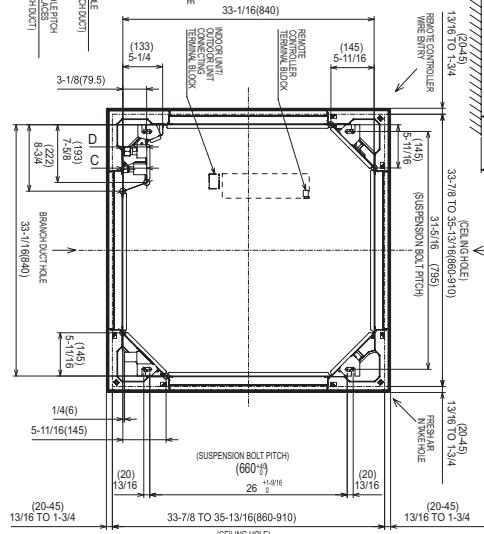
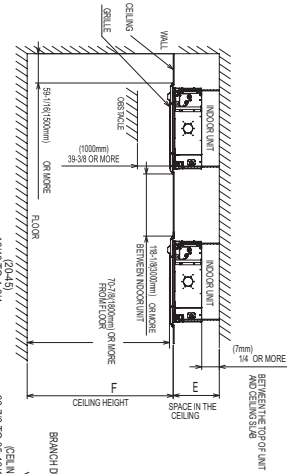
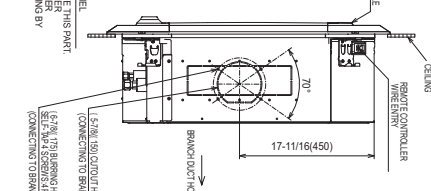
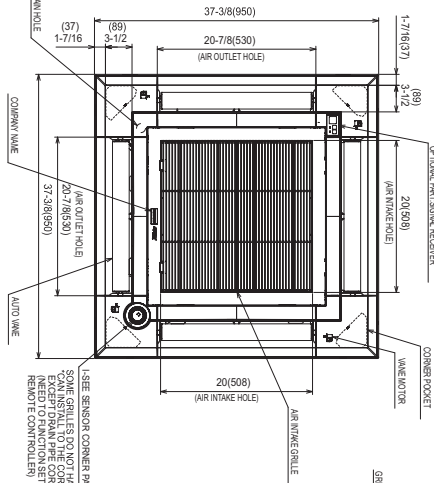

MODELS	①	②	A	B	C	D	E	F
2418R81UH	REFRESH AIR TAKE INDOOR UNIT	REFRESH AIR TAKE INDOOR UNIT	5-1/2 (140)	10-3/8 (268)	3-1/8 (90)	3-1/8 (90)	10-1/2 (267)	10-1/2 (267)
2418R81UH	REFRESH AIR TAKE INDOOR UNIT	REFRESH AIR TAKE INDOOR UNIT	5-1/2 (140)	10-3/8 (268)	3-1/8 (90)	3-1/8 (90)	10-1/2 (267)	10-1/2 (267)
2418R81UH	REFRESH AIR TAKE INDOOR UNIT	REFRESH AIR TAKE INDOOR UNIT	5-1/2 (140)	10-3/8 (268)	3-1/8 (90)	3-1/8 (90)	10-1/2 (267)	10-1/2 (267)

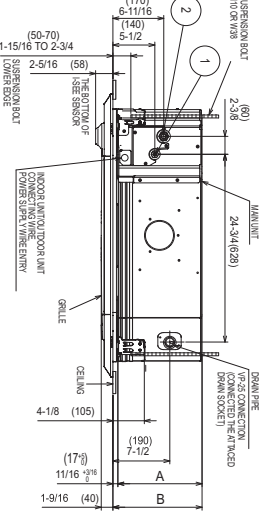
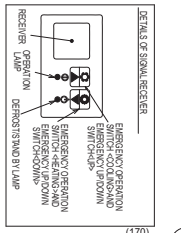

OUTDOOR UNIT DIMENSIONS: PUY-A24NHA7(-BS)

Unit: mm<in>

1 FREE SPACE (Around the unit)

The diagram below shows a basic example. Explanation of particular details are given in the installation manuals etc.

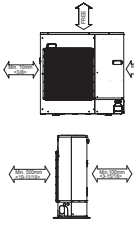

2 SERVICE SPACE

Dimensions of space needed for service access are shown in the below diagram.

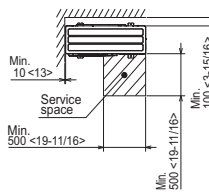

3 FOUNDATION BOLTS

Please secure the unit firmly with 4 foundation (M10<W3/8>) bolts. (Bolts and washers must be purchased locally.)

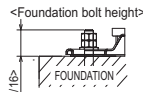

4 PIPING-WIRING DIRECTIONS

Piping and wiring connections can be made from 4 directions: FRONT, Right, Rear and Below.

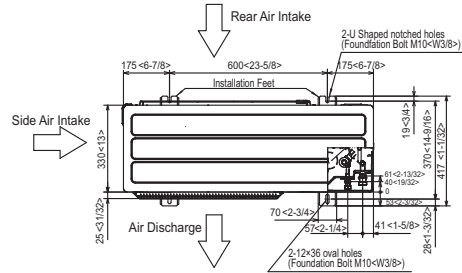

Example of Notes

- ① ... Refrigerant GAS pipe connection (FLARE) ø15.88(5/8F)
- ② ... Refrigerant LIQUID pipe connection (FLARE) ø9.52(3/8F)
- *1... Indication of STOP VALVE connection location.

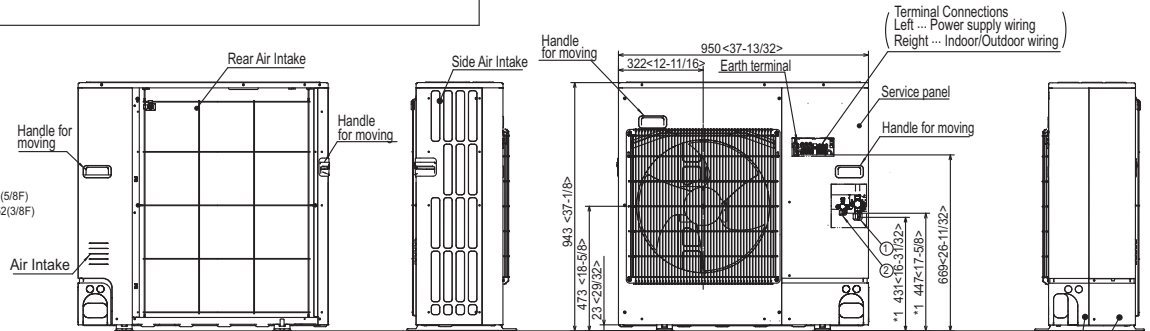

Piping knockout Hole Details

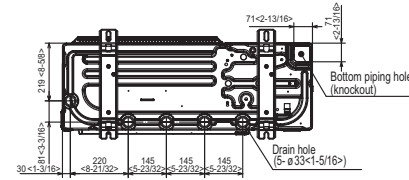
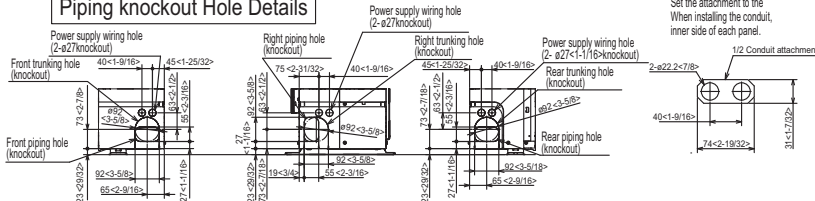

1340 Satellite Boulevard Suwanee, GA 30024
Toll Free: 800-433-4822 www.mehvac.com



FORM# PLA-A24EA7 & PUY-A24NHA7(-BS) - 202103