

Model TSTATG2111-2

Goodman

Air Conditioning & Heating

RESIDENTIAL

1 Day Programmable
Digital Thermostat
MultiStage 2+1



**GREAT
FEATURES!**

Owner's Manual
and
Installation Instructions

Thank goodness for Goodman.™



CAUTION

Follow the Installation Instructions before proceeding. Set the thermostat mode to “OFF” prior to changing settings in setup or restoring Factory Defaults.

This device complies with Part 15 of the FCC Rules. Operation is subject to the following two conditions: (1) this device may not cause harmful interference, and (2) this device must accept any interference received, including interference that may cause undesired operation.

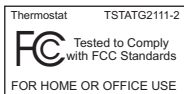

Glossary of Terms

- Auto-Changeover:** A mode in which the thermostat will turn on the heating or cooling based on room temperature demand.
- Cool Setpoint:** The warmest temperature that the space should rise to before cooling is turned on (without regard to deadband).
- Deadband:** The number of degrees the thermostat will wait, once a setpoint has been reached, before energizing heating or cooling.
- Differential:** The forced temperature difference between the *heat setpoint* and the *cool setpoint*.
- Heat Setpoint:** The coolest temperature that the space should drop to before heating is turned on (without regard to deadband).
- Icon:** The word or symbol that appears on the thermostat display.
- Mode:** The current operating condition of the thermostat (i.e. Off, Heat, Cool, Auto, Program On).
- Non-Programmable Thermostat:** A thermostat that does not have the capability of running *Time Period Programming*.
- Programmable Thermostat:** A thermostat that has the capability of running *Time Period Programming*.
- Temperature Swing:** *Same as Deadband.*
- Time Period Programming:** A program that allows the thermostat to automatically adjust the *heat setpoint* and/or the *cool setpoint* based on the time of the day.

Table of Contents

<i>Get to Know Your Thermostat</i>	1
<i>Quick Start</i>	5
<u>INSTALLATION INSTRUCTIONS</u>	7
<i>Sample Wiring Diagrams</i>	11
<i>Test Operation</i>	14
<u>USER SETUP</u>	
<i>Backlight Operation</i>	15
<i>Scrolling Display Options</i>	16
<i>Thermostat Display Options</i>	16
<i>Emergency Heat</i>	17
<i>Wireless Accessories</i>	17
<i>System Runtimes</i>	18
<i>Time Period Programming</i>	19
<u>INSTALLER SETUP</u>	
<i>Program Mode Operation</i>	20
<i>Cycles Per Hour</i>	21
<i>Dry Contact Operation</i>	21
<i>Factory Defaults</i>	22
<i>Locking and Unlocking the Keypad</i>	23
<u>TECHNICIAN SETUP</u>	
<i>Sensor Calibration</i>	24
<i>Equipment Testing</i>	24
<i>Advanced Output Testing</i>	24
<i>Advanced Setup Table</i>	25
<i>Troubleshooting</i>	26
<u>INDEX</u>	27

Get to Know Your Thermostat

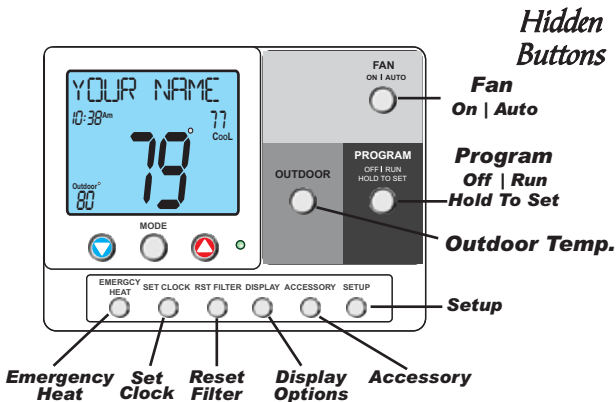
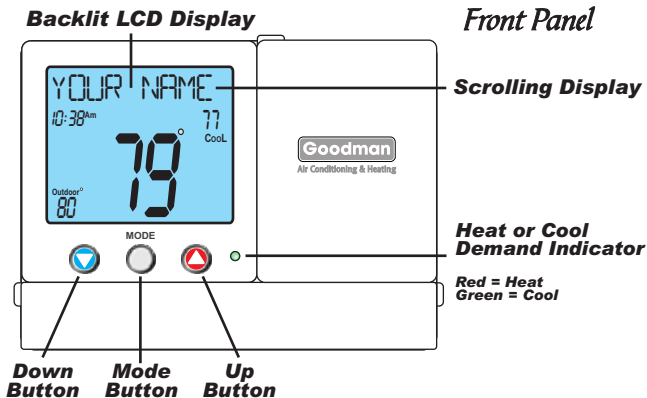

Get to Know Your Thermostat

Display Features

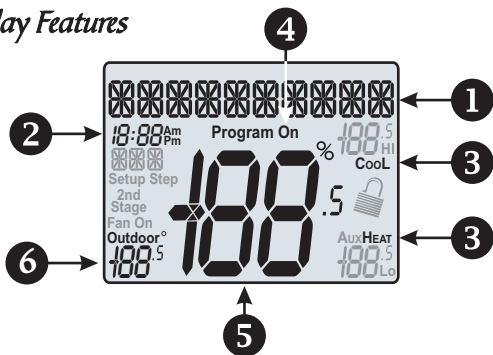

1 The scrolling display will be used to help you easily navigate the setup screens in the thermostat.

2 Clock
Indicates the current time. This clock is also used to program the time period schedule.

3 Mode Indicators
Selects the operational mode of the equipment.
HEAT - Indicates the heating mode.
COOL - Indicates the air conditioning mode.
HEAT & COOL - Indicates the system will automatically change-over between heat and cool modes as the temperature varies.
OFF - Indicates heating and cooling is turned off.

4 Program icon
Indicates that Time Period Programming is running or is enabled to be set.

5 Room Temperature Display
Indicates the current room temperature and displays the outdoor temperature when selected.

6 Outdoor icon
Indicates the temperature displayed is from the optional outdoor sensor.

Get to Know Your Thermostat

Display Features

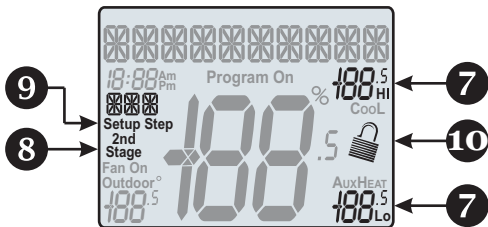

- 7** **Desired Set Temperature**
Indicates desired room temperature(s). Also displays the highest and lowest temperatures for the day.
- 8** **2nd Stage icon**
Indicates what stage of heating is currently energized.
- 9** **Setup Step icon**
Indicates the step number when the thermostat is in the setup mode.
- 10**  **icon**
Indicates the keypad has been locked.

Get to Know Your Thermostat

Display Features

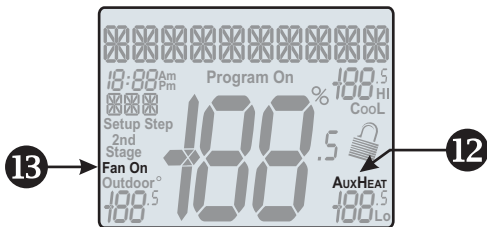

12 AuxHeat icon

Indicates 2nd stage electric strip heat is being used when the thermostat is programmed for Heat Pump operation.

13 Fan On icon

Indicates constant, continuous fan operation.
When **Fan On** is not lit - indicates the fan will only operate when necessary to heat or to cool.

Quick Start

During Setup and Programming:

Press the UP or DOWN buttons to modify the selection.

Press the MODE button to advance and confirm through the setup steps.

Setting the Clock



Press the SET CLOCK button. Adjust the clock using the UP or DOWN buttons. Press the SET CLOCK button to confirm settings.

TIP: To adjust the time by hours press and hold the FAN button while pressing the UP or DOWN buttons.

Selecting the Heat or Cool Mode

Select mode by pressing the MODE button.



Heating Only - The HEAT setting indicates the temperature the room has to reach before the furnace will turn on to heat the room.

Cooling Only - The COOL setting indicates the temperature the room has to reach before the air conditioner will turn on to cool the room.

Heating or Cooling (Auto-Changeover) - AUTO will automatically select heat or cool based on room temperature demand.

OFF - OFF indicates both heating and air conditioning systems are turned off.

NOTE - This thermostat has a fixed two degree deadband. With a Cool setpoint of 72 degrees Fahrenheit, cooling will energize at a room temperature of 74 degrees. With a Heat setpoint of 68 degrees Fahrenheit, heating will energize at 66 degrees.

Quick Start

Selecting Your Desired Temperature

AUTO-CHANGEOVER MODE - Pressing the UP or DOWN buttons in Auto or Program mode will adjust **both** the heat and cool setpoints simultaneously. To adjust heat and cool setpoints individually, choose HEAT mode to adjust the heat setpoint and COOL mode to adjust the cool setpoint, then return to AUTO mode.

HEAT OR COOL MODE - Pressing the UP or DOWN buttons in Heat or Cool mode will adjust only the heat **or** cool setpoints individually displayed.

Using the Fan Button



Fan On indicates constant fan operation.

You may turn the fan on even if the thermostat is in the OFF mode. Pressing the FAN button toggles this feature on or off.

Viewing the Outdoor Temperature Sensor



OUTDOOR TEMP - Press the OUTDOOR button to view the current outdoor temperature. Press the OUTDOOR button again to return to normal operation.

Note: If no outdoor sensor is connected, 2 dashes [- -] will appear with the first button press.

Using the Reset Filter Button



Reset Filter - Press the RST FILTER button to view the current filter runtime. Press the OUTDOOR button to reset the filter runtime counter to 0. Press the RST FILTER button again to return to normal operation.

Installation Instructions

Remove & Replace the Old Thermostat

To install the thermostat properly, please follow these step by step instructions. If you are unsure about any of these steps, call a qualified technician for assistance.

- Assemble tools: Flat blade screwdriver, wire cutters and wire strippers.



- Make sure your Heater/Air Conditioner is working properly before beginning installation of the thermostat.
- Carefully unpack the thermostat. Save the screws, any brackets, and instructions.
- Turn off the power to the Heating/Air Conditioning system at the main fuse panel. Most residential systems have a separate breaker for disconnecting power to the furnace.
- Remove the cover of the old thermostat. If it does not come off easily, check for screws.
- Loosen the screws holding the thermostat base or subbase to the wall and lift away.
- Disconnect the wires from the old thermostat. Tape the ends of the wires as you disconnect them, and mark them with the letter of the terminal for easy reconnection to the new thermostat.
- Keep the old thermostat for reference purposes, until your new thermostat is functioning properly.

Installation Instructions

Wire Connections

If the terminal designations on your old thermostat do not match those on the new thermostat, **refer to the chart below or the wiring diagrams that follow.**

Wire from the old thermostat terminal marked	Function	Install on the new thermostat connector marked
G or F	Fan	G
Y1, Y or C	Cooling	Y1
W1, W or H	Heating	W1/O/B
Rh, R, M, Vr, A	Power	R
C	Common	C
O/B	Rev. Valve	W1/O/B*
W2	2nd Stage Heat	W2
Ck1	Dry Contact Switch	DRY CONTACT
CKGND	Dry Contact Switch	DRY CONTACT
S1, OUT -	Outdoor Sensor	OUTDOOR
S2, OUT +	Outdoor Sensor	OUTDOOR

* O/B is used if your system is a Heat Pump.

Installation Instructions

The TSTATG2111-2 Thermostat Backplate

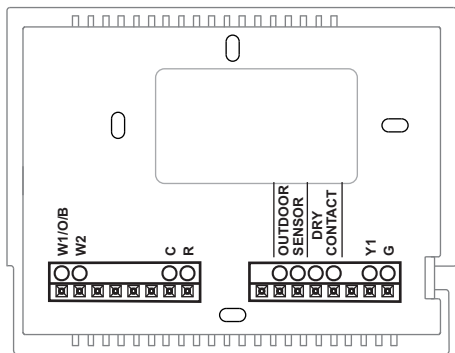

W1/O/B	1st stage heat/reversing valve
W2	2nd stage heat circuit
C	24 VAC common
R	24 VAC Return

OUTDOOR SENSOR	Outdoor Sensor connections
DRY CONTACT	Dry Contact connections
Y1	1st stage compressor
G	Fan relay

IMPORTANT: This thermostat requires both R (24 VAC Return) and C (24 VAC Common) be connected to the backplate terminals.

Installation Instructions

Explanation of Thermostat Jumpers

Jumpers are located on the back of the thermostat

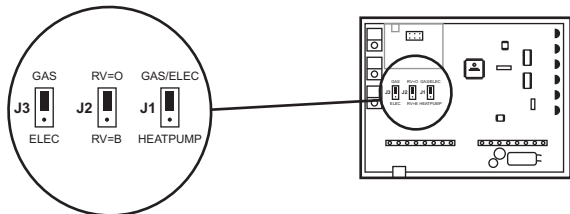

This jumper configures the thermostat to control a conventional gas/electric system or a heat pump. If your system is anything other than a heat pump, leave this jumper set for GAS/ELEC.*

**For some commercial heat pumps, this jumper will need to be set for GAS/ELEC. Consult the commercial heat pump literature.*



When J1 is configured to control a heat pump, this jumper (J2) must be set to control the appropriate reversing valve. If RV=O is chosen, the W1/O/B terminal will energize in cooling. If RV=B is chosen, the W1/O/B terminal will energize in heating.

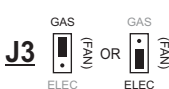

When J1 is set for GAS/ELEC:

This jumper (J3) controls how the thermostat will control the Fan (G) terminal in heating mode. When **GAS** is chosen, the thermostat will not energize the Fan (G) terminal in heating. When **ELEC** is chosen the thermostat will energize the fan in heating.

Installation Instructions

Sample Wiring Diagrams

Conventional Heating and Cooling Systems

3 Wire, Heat Only

Residential & Commercial 1 Stage Heating with no Fan.

R 24VAC Power
C 24VAC Common
W1/O/B 1st Stage Heat

J1 = Gas/Elec
J2 = O (not used)
J3 = Gas

4 Wire, Cool Only

Residential & Commercial 1 Stage Cooling.

R 24VAC Power
C 24VAC Common
Y1 1st Stage Cool
G Fan

J1 = Gas/Elec
J2 = O (not used)
J3 = Gas

5 Wire, 1 Stage Cooling, 1 Stage Heat

Residential & Commercial 1 Stage Cooling, with 1 stage Gas Heat.

R 24VAC Power
C 24VAC Common
W1/O/B 1st Stage Heat
Y1 1st Stage Cool
G Fan

J1 = Gas/Elec
J2 = O (not used)
J3 = Gas

5 Wire, 1 Stage Cooling, 1 Stage Heat

Residential & Commercial 1 Stage Cooling, with 1 stage Electric Heat.

R 24VAC Power
C 24VAC Common
W1/O/B 1st Stage Heat
Y1 1st Stage Cool
G Fan

J1 = Gas/Elec
J2 = O (not used)
J3 = Electric

6 Wire, 1 Stage Cooling, 2 Stage Heat

Residential & Commercial 1 Stage Cooling, with 2 stage Gas Heat.

R 24VAC Power
C 24VAC Common
W1/O/B 1st Stage Heat
W2 2nd Stage Heat
Y1 1st Stage Cool
G Fan

J1 = Gas/Elec
J2 = O (not used)
J3 = Gas

Installation Instructions

Sample Wiring Diagrams

Heat Pump Systems

5 Wire, 1 Stage Cooling, 1 Stage Heat

Residential & Commercial Heat Pump with
'O' Reversing Valve

R	24VAC Power
C	24VAC Common
W1/O/B	Reversing Valve
Y1	1st Stage Compressor (Cool or Heat)
G	Fan
J1	= Heat Pump
J2	= O
J3	= Gas

6 Wire, 1 Stage Cooling, 2 Stage Heat

Residential & Commercial Heat Pump with
'O' Reversing Valve

R	24VAC Power
C	24VAC Common
W1/O/B	Reversing Valve
Y1	1st Stage Compressor (Cool or Heat)
W2	Aux Heat
G	Fan
J1	= Heat Pump
J2	= O
J3	= Electric

Installation Instructions

Sample Wiring Diagrams

Dry Contact and Outdoor Sensor

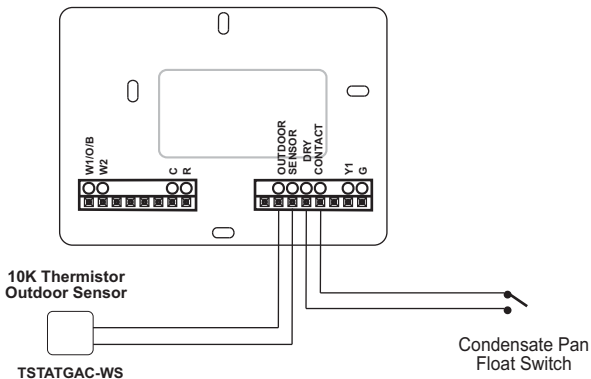

Installation Instructions: Test Operation

This thermostat has a diagnostic feature that enables testing of all outputs. This feature is contained in **Technician Setup**.

*To enter Technician Setup, press and hold the **SETUP** button for 5 seconds until all the icons appear. Follow the next steps to view settings and test equipment.*

1. Press **MODE** to view the version numbers of the thermostat.
2. Press **MODE** again to view the jumper settings and current state of the Dry Contact terminals.
3. Press **MODE** again and the scrolling display will read "TURN ON EQUIPMENT?" Press **UP** for Yes or **DOWN** for No.

If Yes is chosen, press **UP** to turn on heat or **DOWN** to turn on Cooling. The scrolling display will read "NOTHING ON." Next:

Press **UP** to turn on and cycle up through the heating stages. Press **DOWN** to turn the heating stages off. Press **MODE** to exit.

Press **DOWN** to turn on and cycle down through the cooling stages. Press **UP** to turn the cooling stages off. Press **MODE** to exit.

4. Press **MODE** until "CALIBRATE SENSORS?" appears on the scrolling display. Press **UP** for Yes or **DOWN** for No. Use **UP** or **DOWN** to modify your selection.

*To exit Technician Setup at any time, press the **SETUP** button. Technician Setup will automatically exit after 10 minutes if no buttons are pressed.*

User Setup: Backlight Operation

How to Change Settings in the Setup Screens

To enter Advanced Setup, press the **SETUP** button, then press **MODE**. Use the **UP** or **DOWN** buttons to adjust the value of your selection. Press **MODE** to advance to the next setup step. Press **SETUP** again to leave the setup screens.



Backlight (Setup Step 3)

The thermostat backlight may be set to be always on, on temporarily with any button press, on throughout the evening, or always off. (For always off, see Backlight Level)

Press the **SETUP** button, then press **MODE** repeatedly until the Backlight setup step appears. Use the **UP** or **DOWN** buttons to make selection. Press **MODE** to advance to the next step. Press **SETUP** to leave the setup screens.

Backlight Off - Backlight turns on with any button press and turns off after 8 seconds.

Backlight On - Backlight is on continuously.

Backlight 6pm to 6am - Backlight turns on at 6pm and turns off at 6am.

Backlight Level (Setup Step 4)

The backlight can be adjusted between always off and seven levels of brightness.

Press the **SETUP** button, then press **MODE** repeatedly until the Backlight setup step appears. Use the **UP** or **DOWN** buttons to adjust the brightness. Press **MODE** to advance to the next step. Press **SETUP** to leave the setup screens.

Language (Setup Step 16)

Setup step instructions on the scrolling display can be set for English, Spanish, or French.

Press the **SETUP** button, then press **MODE** repeatedly until the Language setup step appears. Use the **UP** or **DOWN** buttons to make selection. Press **MODE** to advance to the next step. Press **SETUP** to leave the setup screens.

User Setup: Scrolling Screen and Display Options

Scrolling Display Method (Setup Step 17)

This option allows the user to choose how the scrolling text is displayed. Options are:

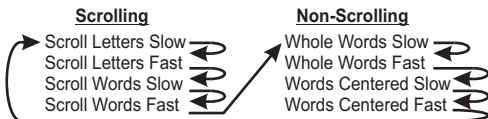

Press the **SETUP** button, then press **MODE** repeatedly until the Scrolling Method setup step appears. Use the **UP** or **DOWN** buttons to make a selection. Press **MODE** to advance to the next step. Press **SETUP** to leave the setup screens.



Example of “Whole Words Centered”:

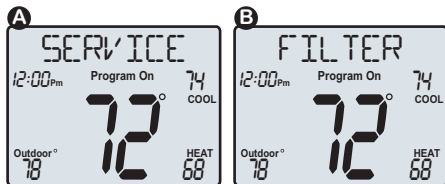

Display

This option allows the user to “de-clutter” the thermostat display screen by removing icons from the main display. The room temperature will always be shown. Service information may also be viewed by pressing and holding the **DISPLAY** button.

Each press of the **DISPLAY** button will remove icons. Keep pressing **DISPLAY** to make icons reappear.

Press and hold **DISPLAY** for 5 seconds to view a name and phone number to call for service.

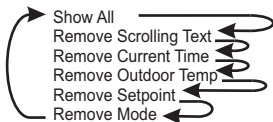

Any removed icons will be displayed temporarily when a setting change is made.

User Setup

Emergency Heat



The Emergency Heat function is only available if your thermostat is set to control a Heat Pump.

To initiate the Emergency Heat feature, **Press and hold the EMERGENCY HEAT button for 2 seconds.** During Emergency Heat operation the thermostat will turn on the fan and auxiliary stages of heat when there is a demand for heat. The 1st stage of heating and all stages of cooling will be unavailable. To exit Emergency Heat, press the EMERGENCY HEAT button.

Accessory



The optional RF Module must be installed to link and view wireless accessories.



The ACCESSORY button allows the user to view wired and wireless sensors and “link” these and other wireless devices to the thermostat via an optional RF module. Press the ACCESSORY button to enter the Accessory setup screen. Press UP to view linked and wired accessories. Follow the instructions included with the wireless accessory to begin linking process. Next, press DOWN to enter the wireless linking mode. Press MODE to initiate linking. Press ACCESSORY to return to the main screen. **NOTE:** A wired outdoor sensor's temperature reading is updated once every minute; a wireless outdoor sensor's temperature reading is updated once every 5 minutes.

User Setup: System Runtimes

These setup steps allow the user to monitor equipment runtimes and program service alerts.

Runtime hours or days appear in the clock display.



Service Filter Runtime (Setup Steps 5-6, 12-13)

Press the SETUP button, then press MODE repeatedly until the desired setup step appears. Use the UP or DOWN buttons to make selection. Press MODE to advance to the next step. Press SETUP to leave the setup screens.

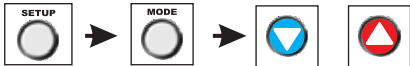

Current Service Filter Runtime Hours (Setup Step 5) - This counter keeps track of the number of hours of fan runtime in the Heating mode, Cooling mode, and in stand alone Fan operation. Press FAN to reset.

Current Service Filter Calendar Days (Setup Step 6) - This counter displays the total number of calendar days that have elapsed since the counter was reset to help the user track Fan runtime. Press FAN to reset.

Set Service Filter Runtime Hours (Setup Step 12) - This timer allows the user to specify the number of hours the fan will run before the "Replace Filter" alert will be displayed. Press DOWN continuously until OFF is displayed to disable this alert.

Set Service Filter Calendar Days (Setup Step 13) - This timer allows the user to specify the number of calendar days that will elapse before the "Replace Filter" alert will be displayed. Press DOWN continuously until OFF is displayed to disable this feature.

UV Lamp Runtime (Setup Steps 10, 14)

Current UV Lamp Calendar Days (Setup Step 10) - This counter displays the total number of calendar days that have elapsed to help the user track UV lamp runtime. Press FAN to reset.

Set UV Lamp Calendar Days (Setup Step 14) - This timer allows the user to specify the number of calendar days the UV Lamp will operate before the "Replace UV Lamp" alert will be displayed. Press DOWN continuously until OFF appears to disable this alert.

User Setup: Time Period Programming

To enter Time Period Programming screens, Press and hold PROGRAM until the scrolling prompt appears.

OFF - Time Period Program is off.

RUN - Time Period Program is running.

HOLD TO SET - Press and hold PROGRAM to make Time Period Programming changes.

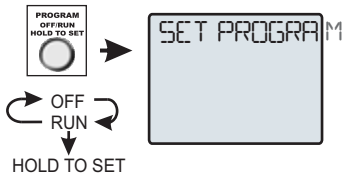

Programming a Daily Schedule



This thermostat features four programmable time periods per 24 hour day: Morning, Day, Evening, and Night. The start time for each time period is adjustable. The stop time for each time period is the start time for the next.

Select Morning Start Time - Press the UP or DOWN buttons to adjust the time of day desired. Press MODE to advance to the next step.

Select Morning Cool Setpoint - Press the UP or DOWN buttons to adjust the cool setpoint desired. Press MODE to advance to the next step.

Select Morning Heat Setpoint - Press the UP or DOWN buttons to adjust the heat setpoint desired. Press MODE to advance to the next step.

Repeat Start Time and Setpoint programming for Day, Evening, and Night.

Press the PROGRAM or MODE Button to exit Time Period Programming

Installer Setup

How to Change Settings in the Setup Screens

To enter Advanced Setup, press the **SETUP** button, then press **MODE**. Use the **UP** or **DOWN** buttons to adjust the value of your selection. Press **MODE** to advance to the next setup step. Press **SETUP** again to leave the setup screens.



Selecting Your Program Mode (Setup Step 1)

This thermostat may be configured to be programmable or non-programmable.

Non Program - No advanced time period programming available.

1 Day Program - Allows one 24 hour day to be programmed. This same schedule will be repeated everyday the program is set to run.

Selecting Your Available Modes (Setup Step 2)

Auto-Changeover - Allows the thermostat to turn on heating or cooling based on room temperature demand. Also allows the manual selection of HEAT only or COOL only and OFF.

Heat and Cool - Allows the thermostat to turn on heating or cooling depending on which one has been manually selected. Auto-Changeover is not available when this is selected.

Heat Only - Allows the thermostat to only turn on HEAT or OFF modes.

Cool Only - Allows the thermostat to only turn on COOL or OFF modes.

Installer Setup

Cycles Per Hour (Setup Step 21)

The Cycles Per Hour setting may limit the number of times per hour your HVAC unit may energize. For example, at a setting of 6 cycles per hour the HVAC unit will only be allowed to energize once every 10 minutes. The Cycles Per Hour limit may be overridden and reset by pressing the UP or DOWN buttons on the thermostat. Settings are No Limit, 2, 3, 4, 5, or 6.

Compressor Minimum Off Minutes (Setup Step 22)

This feature allows the user to set a minimum off time for the compressor. Settings are 5 mins., 3 mins., or 0 mins.

Minimum Heat/Cool Setpoint Difference (Setup Step 23)

This feature allows the user to set the minimum gap between Heat and Cool setpoints in **AUTO** mode. Select from 0 to 6. If setup step 2 is not set for **AUTO-CHANGEOVER**, this step will not appear.

Fahrenheit or Celsius (setup step 57)

This feature allows the thermostat to display temperature in Fahrenheit or Celsius.

Dry Contact Operation (setup step 71)

Dry Contact Polarity (Setup Step 71)

Open (Normally Open) - The dry contact is open until the connected device closes the circuit.



'Idle'



'Active'

Closed (Normally Closed) - The dry contact is closed until the connected device opens the circuit.



'Idle'



'Active'

When the dry contact is active, the thermostat will lockout the compressor terminal(s) and "SERVICE DRAIN PAN" will appear on the display.

Press Fan To Clear All Messages (setup step 76)

This feature allows the user to clear all current error messages from the display.

Installer Setup

Resetting the Thermostat to the Factory Default Settings (for default values see page 25)

If, for any reason, you desire to return all the stored settings back to the factory default settings, follow the instructions below.

WARNING: This will reset all Time Period and Advanced Programming to the default settings. Any information entered prior to this reset may be permanently lost.

- 1 Press and hold SETUP for 5 seconds. All icons will appear on the display.



Keep pressing the SETUP button until you see this screen.

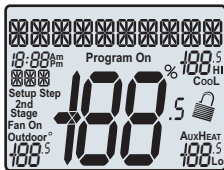

- 2 After all the icons appear, release SETUP. Press and hold FAN for 5 seconds. DEFAULTS will appear on the display.



Keep pressing the FAN button until you see this screen.

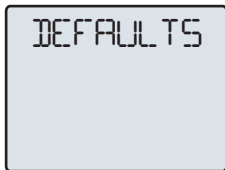

- 3 After DEFAULTS appears, release FAN. Press SETUP to return to normal operation.





Installer Setup

Locking/Unlocking the Keypad

To prevent unauthorized use of the thermostat, the front panel buttons may be disabled. To disable, or 'lock' the keypad, press and hold the MODE button. While holding the MODE button, press the UP and DOWN buttons together. The  icon will appear on the display, then release the buttons.

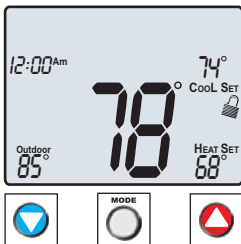
Press all three buttons in the order outlined above for keypad lockout



To **unlock** the keypad, press and hold the MODE button. While holding the MODE button, press the UP and DOWN buttons together. The  icon will disappear from the display, then release the buttons.

Technician Setup

To enter Technician Setup, press and hold the **SETUP** button for 5 seconds. After all the icons appear, press **MODE**. The version number of the thermostat will appear in the scrolling text. Press **MODE** to advance to the next step. Use the **UP** or **DOWN** buttons to adjust the value of your selection. To leave Technician Setup, press **SETUP**.

Hold for 5 seconds



All icons appear

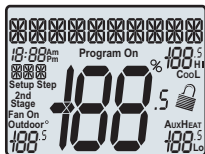

Press **MODE** to advance through the setup steps



Press **UP** or **DOWN** to adjust the selection



Technician Setup is for diagnostic and testing purposes and is intended for use by a qualified technician. See page 14 for more detailed instructions.

Technician Setup contains the following options:

- View the version number of the thermostat.
- View the jumper setting of **J1** (Gas/Electric or Heat Pump), **J2** (Reversing Valve: RV=O or RV=B), and **J3** (Fan: Gas or Electric) jumpers located on the back of the thermostat. (Remove thermostat from backplate for access)
- View the state of the Dry Contact terminal.
- Turn on equipment outputs for testing.
- Calibrate thermostat sensor.

Advanced Setup Table

Df = Factory Default Setting

Step#	Description	Pg#	Range	Df
1	Prog Mode	20	Non, 1	1
2	Available Modes	20	Heat/Cool/Auto/Off, Heat/Cool/Off,Heat/Off, Cool/Off	Heat/Cool/ Auto/Off
3	Backlight	15	On,Off,6pm-6am	Off
4	Backlight Level	15	Off-7 levels of brightness	Level 5
5	Current Service Filter Runtime Hours	18	0-1999	0
6	Current Service Filter Calendar Days	18	0-1999	0
10	Current UV Lamp Calendar Days	18	0-1999	0
12	Set Service Filter Runtime Hours	18	0-1950	0
13	Set Service Filter Calendar Days	18	0-720	0
14	Set UV Lamp Calendar Days	18	0-720	0
16	Language	15	English,Espanol,Francais	English
17	Scrolling Method	16	L-R Slow,L-R Fast,Word L-R Slow,Word L-R Fast, Whole Word L Slow, Whole Word L Fast, Whole Word Ctr Slow, Whole Word Ctr Fast	Whole Word Ctr Fast
21	Cycles Per Hour	21	No Limit,2,3,4,5,6	6
22	Compressor Minimum Off Minutes	21	0,3,5	5
23	Minimum Heat/Cool Setpoint Difference	21	0°-6°	2°
57	F/C	21	Fahrenheit,Celsius	F
71	Dry Contact Polarity	21	Open,Closed	Open
76	Press Fan To Clear All Messages	21	N/A	N/A

TroubleShooting

- **SYMPTOM:** The air conditioning does not attempt to turn on.
CAUSE: The compressor timer lockout may prevent the air conditioner from turning on for a period of time.
REMEDY: Consult the Owner's Manual in the Installer Setup section to defeat the Cycles Per Hour (page 21).
- **SYMPTOM:** The display is blank.
CAUSE: Lack of proper power.
REMEDY: Make sure the power is on to the furnace and that you have 24vac between **R & C**.
- **SYMPTOM:** The air conditioning does not attempt to turn on.
CAUSE: The cooling setpoint is set too high.
REMEDY: Lower the cooling setpoint.
- **SYMPTOM:** The heating does not attempt to turn on.
CAUSE: The heating setpoint is set too low.
REMEDY: Raise the heating setpoint.
- **SYMPTOM:** When controlling a residential heat pump, and asking for cooling, the heat comes on.
CAUSE: The thermostat reversing valve jumper is set for "**B**".
REMEDY: Set the reversing valve jumper for "**O**".
- **SYMPTOM:** When calling for cooling, both the heat and cool come on.
CAUSE: The thermostat equipment jumper is configured for "**HP**" and the HVAC unit is a Gas/Electric.
REMEDY: Set the equipment jumper for "**Gas**".
- **SYMPTOM:** When the Program button is pressed, the display reads "DISABLED".
CAUSE: Program mode is set to "**NON PROGRAM**".
REMEDY: Set Program Mode (Setup 1) to **1 Day**.
See Selecting Your Program Mode (page 20).



Alerts

see *Runtime*

Accessory, 17

Auto

adjust temperature, 6
changeover, 6, 20
fan, 6
mode, 5, 20

AuxHeat icon, 4



b reversing valve, 10, 24

Backplate, 9

Buttons

accessory, 1, 17
down (cooler) 1, 5
display, 1, 16
emergency heat, 1, 17
fan, 1, 6,
front panel, 1
mode, 1, 5
outdoor, 1, 6

program, 1, 19
reset filter, 1, 6
set clock, 1, 5
setup, 1, 15, 20
up (warmer), 1, 5



C, 25

Calibration, 14, 24

Celsius, 21, 27

Clock

display, 2
setting, 5

Compressor Lockout, 21

Cool

1st stage
deadband,
electric/heat pump, 5
icon, 2
indicator, 1
mode, 2, 5
setpoint, 2, 6, 19

Condensate Drain Pan, 21

Cycles Per Hour, 21



Day

programming, 19
setting, 19

Differential

heat and cool, 21

Disabled Keypad

see *Keypad Lockout*

Drain Pan Overflow

Alarm, see Dry Contact

Dry Contact

operation, 21
polarity, 21
service pan, 21



Electric Heating

AuxHeat icon, 2
jumper setting, 10

Emergency Heat, 17



Factory Defaults

- caution, i
- settings, 25
- resetting, 22

Fahrenheit, 21

Fan

- button function, see *Buttons*
- on during heat, see *Electric Heat*
- on icon, 4
- 2nd stage heat, see *Emergency Heat*



Gas/Electric Furnace

- jumper, 10

Green Indicator, 1



Heat

- 1st stage
 - deadband, see *Deadband*
 - emergency heat, 17
 - electric strip heat, 17
 - electric/heat pump, 10
 - indicator, 1
 - mode, 2, 5
 - setpoint, 6, 19

Heat Pump

- AuxHeat, 12
- emergency heat, 17
- jumper setting, 10
- multi-stage, 11, 12



Jumpers

- ELEC, 10
- electric heat, 10
- gas electric, 10
- heat pump, 10
- reversing valve, 10
- viewing, 14, 24



Keypad Lockout, 23



LCD, 1

Locked Indication,

- see *Keypad Lockout*



Manual

- changeover, 20
- cool, 20
- heat, 20

Mode, 2, 5, 20

Multi-stage Operation, 11, 12

Index



Non-Programmable Thermostat, 20

Normally Open/Closed,
dry contact, 21



O Reversing Valve
see *Reversing Valve*

Off Mode, 2, 5

Outdoor

button, see *Buttons*
icon, 2
sensor, 6, 13
viewing, 6



Pan, Service
see *Dry Contact*

Polarity, see Dry Contact
Programmable Thermostat, 20

Programming a Daily Schedule, 19



Reset
thermostat settings,
see *Factory Defaults*
runtime

fan/filter, 18
UV light, 18

Reversing Valve, 10

Runtime

resetting, see *Reset*
setting,

service filter, 18
UV light, 18

viewing,
service filter, 18
UV light, 18



Schedule

Daily, see *Program*

Sensor

outdoor, see *Outdoor*
thermostat, see
Thermostat

Service

filter, see *Reset*

pan, see *Dry Contact*
UV light, see *Reset*

Set Clock, see Clock

Setpoint

cool, see *Cool*
heat, see *Heat*

Simplest Operation, 5



Technician Setup, 14, 24

Thermostat Sensor

calibrate, 14, 24

Time, see Clock

Time Schedule, see Program



UV Light

resetting, 18
runtime, see *Runtime*
setting, see *Runtime*



Warranty, 30

Warranty

Five-Year Warranty - This Product is warranted to be free from defects in material and workmanship. If it appears within five years from the date of original installation, whether or not actual use begins on that date, that the product does not meet this warranty, a new or remanufactured part, at the manufacturer's sole option to replace any defective part, will be provided without charge for the part itself provided the defective part is returned to the distributor through a qualified servicing dealer.

THIS WARRANTY DOES NOT INCLUDE LABOR OR OTHER COSTS incurred for diagnosing, repairing, removing, installing, shipping, servicing or handling of either defective parts or replacement parts. Such costs may be covered by a separate warranty provided by the installer.

THIS WARRANTY APPLIES ONLY TO PRODUCTS IN THEIR ORIGINAL INSTALLATION LOCATION AND BECOMES VOID UPON REINSTALLATION.

LIMITATIONS OF WARRANTIES – ALL IMPLIED WARRANTIES (INCLUDING IMPLIED WARRANTIES OF FITNESS FOR A PARTICULAR PURPOSE AND MERCHANTABILITY) ARE HEREBY LIMITED IN DURATION TO THE PERIOD FOR WHICH THE LIMITED WARRANTY IS GIVEN. SOME STATES DO NOT ALLOW LIMITATIONS ON HOW LONG AN IMPLIED WARRANTY LASTS, SO THE ABOVE MAY NOT APPLY TO YOU. THE EXPRESSED WARRANTIES MADE IN THIS WARRANTY ARE EXCLUSIVE AND MAY NOT BE ALTERED, ENLARGED, OR CHANGED BY ANY DISTRIBUTOR, DEALER, OR OTHER PERSON WHATSOEVER.

ALL WORK UNDER THE TERMS OF THIS WARRANTY SHALL BE PERFORMED DURING NORMAL WORKING HOURS. ALL REPLACEMENT PARTS, WHETHER NEW OR REMANUFACTURED, ASSUME AS THEIR WARRANTY PERIOD ONLY THE REMAINING TIME PERIOD OF THIS WARRANTY.

THE MANUFACTURER WILL NOT BE RESPONSIBLE FOR:

1. Normal maintenance as outlined in the installation and servicing instructions or owner's manual, including filter cleaning and/or replacement and lubrication.
2. Damage or repairs required as a consequence of faulty installation, misapplication, abuse, improper servicing, unauthorized alteration or improper operation.
3. Failure to start due to voltage conditions, blown fuses, open circuit breakers or other damages due to the inadequacy or interruption of electrical service.
4. Damage as a result of floods, winds, fires, lightning, accidents, corrosive environments or other conditions beyond the control of the Manufacturer.
5. Parts not supplied or designated by the Manufacturer, or damages resulting from their use.
6. Manufacturer products installed outside the continental U.S.A., Alaska, Hawaii, and Canada.
7. Electricity or fuel costs or increases in electricity or fuel costs for any reason whatsoever including additional or unusual use of supplemental electric heat.
8. ANY SPECIAL INDIRECT OR CONSEQUENTIAL PROPERTY OR COMMERCIAL DAMAGE OF ANY NATURE WHATSOEVER. Some states do not allow the exclusion of incidental or consequential damages, so the above may not apply to you.

This warranty gives you specific legal rights and you may also have other rights which may vary from state to state.

Notes:



Printed on recycled paper.
P/N 88-890 Rev. 1