

FRESH-AIRE MINI UV LED

Mini-Split Installation Instructions

Fresh-Aire Mini UV LED improves indoor air quality and fights biological contamination inside mini-splits, particularly on the blower wheel.

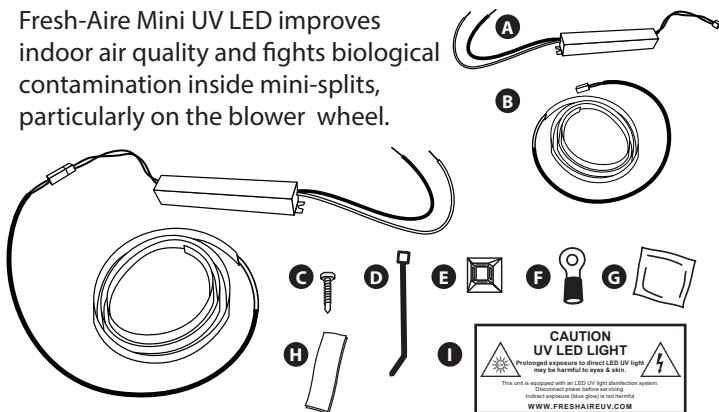

Parts Included

- A** Driver
- B** LED Strip
- C** Screws
- D** Zip Ties
- E** Zip Tie Base
- F** Ring Connectors
- G** Alcohol Wipe
- H** Adhesive Tape
- I** UV Warning Sticker

Optional

- J** Nighttime switch



IMPORTANT!

- Only qualified technicians should install this product
- Install in accordance with relevant building codes
- Read instructions carefully including safety warnings

© Fresh-Aire UV

TUV-MINI-LED-MAN 7.12.19

Installation Notes

Mini UV LED is typically used for mini split systems and other limited space applications. Because space is tight the best place for mounting the LED lights is usually inside the supply vent with the light shining onto the blower wheel (which is prone to the worst mold growth).

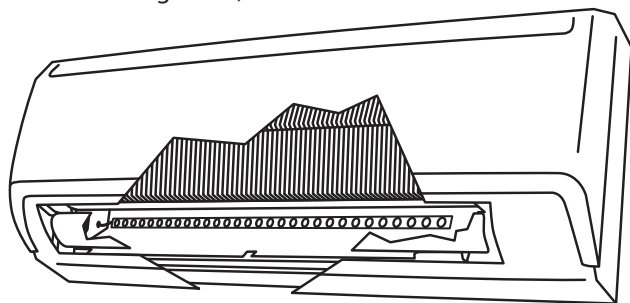

Cutaway view of typical Mini UV LED® installation in mini split



CAUTION UV LED LIGHT

Prolonged exposure to direct LED UV light may be harmful to eyes & skin. Disconnect power before servicing. Indirect exposure (blue glow) is not harmful.



IMPORTANT!

Install LED strip so that the light shines into the air system, not into the room.

Air System Preparation

1. Remove cover.

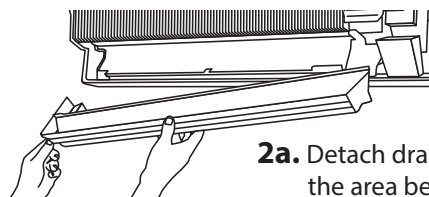
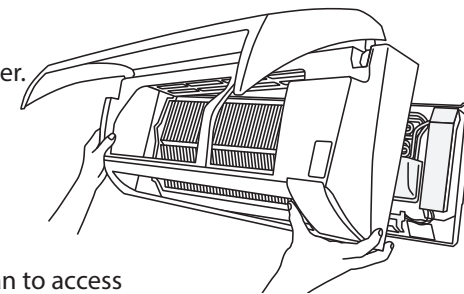

- 2a. Detach drain pan to access the area behind it.

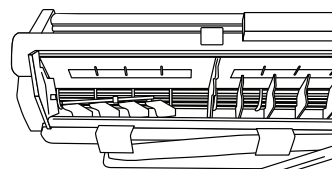

- 2b. For systems with non-removable drain pan, remove louvers and baffles to access the area behind.

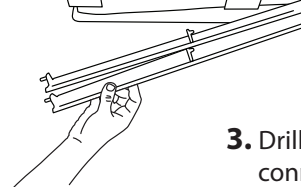

3. Drill a 1/2" hole to pass connector cable through to back of unit as needed.

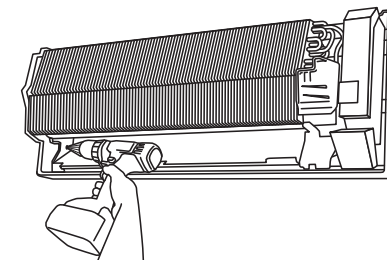

LED Strip Mounting

1. Determine the best location for the LED Strip and clean that area with the alcohol wipe.
2. If needed shorten the LED strip by 4" segments (**cut only between copper squares on strip**).
3. Pass the connector cable through the drilled hole.
4. Peel off paper from the adhesive backing on the LED strip a few inches at a time and press it down firmly onto the clean surface.

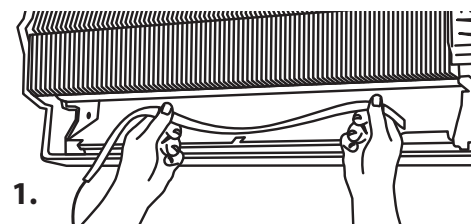

1.

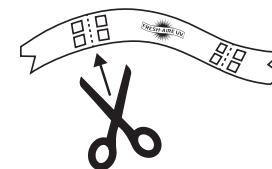

2.

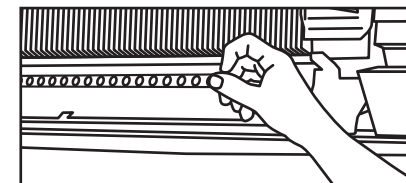

4.

IMPORTANT!

Place the LED strip so the light will shine on blower wheel and mold prone areas, **NOT INTO THE ROOM.**

Power Supply Installation

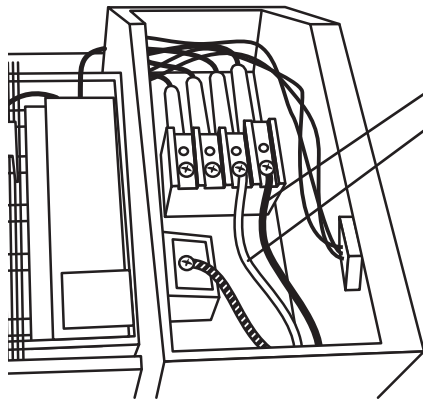

1. Remove the control box cover and connect the wiring harness as shown.

LED Driver wiring

- Black to hot terminal
- White to neutral (typically S1 & S2)

2. Wiring Diagram*

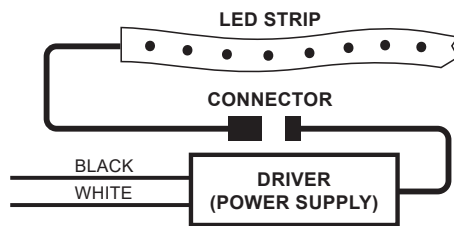

Note: Some indoor systems may require additional wiring to provide line voltage to the Mini UV LED power supply.

* Mini UV LED comes with a 120, 208, 240 VAC driver (power supply)

3. Insert the UV lamp cable connectors and wiring harness connector into the power supply.

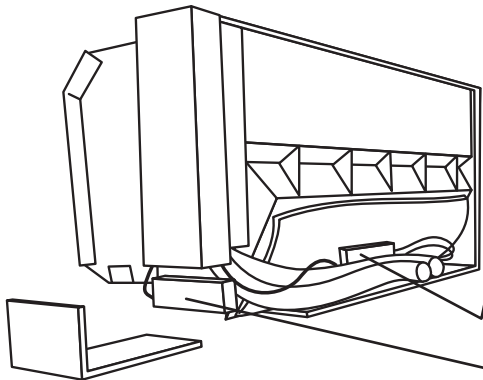

4. Tuck the power supply into the line chase on the back of the ac unit or place it in or under the control box or other secure location.

5. Return power to the system and confirm that Mini UV LED is working.

6. Apply the UV warning sticker in an appropriate location.

Optional Switch Installation

1. Select an appropriate location for the on/off switch on the mini-split access panel that is within 12" of the LED driver 12 VDC AMP connector.

2. Drill a 7/8" hole and insert switch.

3. Connect switch in series between driver and LED strip using the AMP connectors.

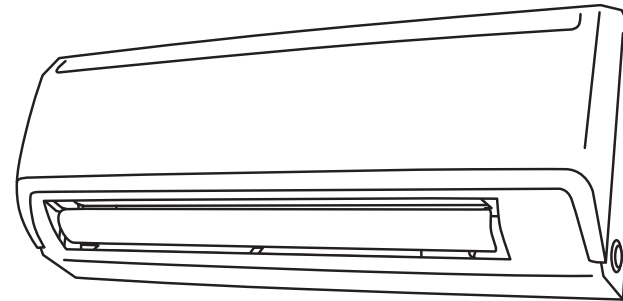
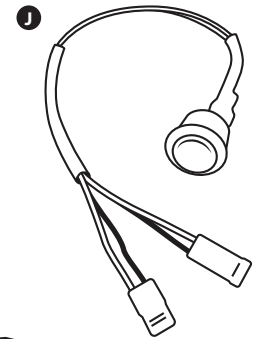

Manufacturer's Warranty:

This warranty supersedes and replaces any warranty statements orally made by the Sales Person, Distributor or Dealer or contained in the written instructions or other Brochures or informational documents in relation to this product. This warranty gives you specific legal rights, and you may also have other rights which vary from State to State.

What Does This Warranty Cover? The warranty covers any defects or malfunctions in material and workmanship under the normal use and service when operated and maintained in strict accordance with manufacturer's instructions for the Lifetime of the equipment.

How Long Does The Coverage Last? 1) Fresh-Aire Mini UV LED is warranted for five years from the date of installation. This warranty is not transferable.

What Will Triatomic Environmental, Inc. Do? Triatomic Environmental, Inc. will replace any defective or malfunctioning part at no charge. You must pay any labor charges and shipping charges of defective product to our warranty department.

What Does This Warranty Not Cover? THIS PRODUCT IS NOT INTENDED TO BE PURCHASED AND INSTALLED BY UNLICENSED HVAC OR ELECTRICAL CONTRACTORS. This warranty does not cover products or parts purchased from any source other than licensed HVAC or electrical contractors. This warranty does not cover parts installed by unlicensed HVAC or electrical contractors. This warranty does not cover parts damaged as a result of misuse, abuse, or any use other than its intended use, accident, acts of god, neglect, or from improper operation, maintenance, installation, modification or adjustments. Triatomic Environmental, Inc. shall have no responsibility for charges incurred by the customer for installation or removal of warranted items.

This warranty does not cover parts or equipment used with the Fresh-Aire UV system that are not manufactured by Triatomic Environmental, Inc.

Consequential and incidental damages are not recoverable under this warranty. Manufacturer assumes no liability for any harm, which may occur as a result of the use of the equipment herein and shall not be liable for consequential or any other damages whether or not caused by manufacturer's negligence or resulting from any express or implied warranty or breach thereof. Consequential damages for the purpose of this warranty shall include, but not be limited to, loss of use, income or profit, or loss of or damages to property or injury or death to persons or animals occasioned by or arising out of operation, use, the operation, installation, repair or replacement of the equipment or otherwise. Some states do not allow the exclusion or limitation of incidental or consequential damages, so the above limitation or exclusion may not apply to you.

There are no Warranties which extend beyond the description of the face hereof.

How Do You Get Service? In order to be eligible for service under this warranty you MUST return the warranty registration card or register online at www.freshaireuv.com. If something is wrong with your product, call your installing contractor to receive a Return Merchandise Authorization (RMA) and instructions for returning the product to a licensed distributor in your area or the manufacturer.

Once the product is returned, we will inspect your product and contact you within 10 business days of our receipt of the product to give the results of our inspection. If we determine that the product is covered under this warranty, we will ship to you at no additional cost a replacement part. Replacement parts may be refurbished. If we determine that the product is not covered under this warranty, or that this warranty is void, the product will be returned to you COD. There is no charge for inspection.

How Does State Law Apply? This warranty gives you specific legal rights, and you may also have other rights which vary from state to state.