

DAIKIN

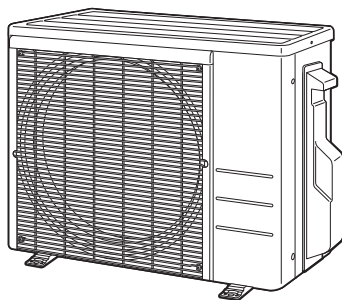

DAIKIN ROOM AIR CONDITIONER

INSTALLATION MANUAL

R410A Split Series



Installation manual
Manuel d'installation
Manual de instalación

English

Français

Español

MODELS

| | | |
|------------|------------|------------|
| RX09NMVJU | RK09NMVJU | RXL09QMVJU |
| RX12NMVJU | RK12NMVJU | RXL12QMVJU |
| RX18NMVJU | RK18NMVJU | RXL15QMVJU |
| RX24NMVJU | RK24NMVJU | |
| RXN09NMVJU | RKN09NMVJU | |
| RXN12NMVJU | RKN12NMVJU | |
| RXN18NMVJU | RKN18NMVJU | |
| RXN24NMVJU | RKN24NMVJU | |

Contents

| | | | |
|--|---|--|----|
| Safety Considerations | 1 | 3. Flaring the pipe end..... | 6 |
| Accessories | 3 | 4. Refrigerant piping | 6 |
| Precautions for Selecting a Location | 3 | 5. Pressure test and evacuating system..... | 7 |
| Precautions on Installation | 4 | 6. Refilling refrigerant | 8 |
| Outdoor Unit Installation Diagram | 4 | 7. Refrigerant piping work | 8 |
| Installation Space Requirements | 5 | Wiring | 9 |
| Outdoor Unit Installation | 5 | Facility Setting (cooling at low outdoor temperature) | 11 |
| 1. Installing the outdoor unit | 5 | Pump Down Operation | 11 |
| 2. Drain work (only for heat pump models, excluding RXL models) | 6 | Trial Operation and Testing | 12 |
| | | 1. Trial operation and testing | 12 |
| | | 2. Test items | 12 |

Safety Considerations

Read these **Safety Considerations for Installation** carefully before installing an air conditioner or heat pump. After completing the installation, make sure that the unit operates properly during the startup operation.

Instruct the user on how to operate and maintain the unit.

Inform users that they should store this installation manual with the operation manual for future reference.

Always use a licensed installer or contractor to install this product. Improper installation can result in water or refrigerant leakage, electric shock, fire, or explosion.

Meanings of **DANGER**, **WARNING**, **CAUTION**, and **NOTE**

Symbols:

 **DANGER** Indicates an imminently hazardous situation which, if not avoided, will result in death or serious injury.

 **WARNING** Indicates a potentially hazardous situation which, if not avoided, could result in death or serious injury.

 **CAUTION** Indicates a potentially hazardous situation which, if not avoided, may result in minor or moderate injury. It may also be used to alert against unsafe practices.

 **NOTE** Indicates situations that may result in equipment or property-damage accidents only.

DANGER _____

- Refrigerant gas is heavier than air and replaces oxygen. A massive leak can lead to oxygen depletion, especially in basements, and an asphyxiation hazard could occur leading to serious injury or death.
- Do not ground units to water pipes, gas pipes, telephone wires, or lightning rods as incomplete grounding can cause a severe shock hazard resulting in severe injury or death. Additionally, grounding to gas pipes could cause a gas leak and potential explosion causing severe injury or death.

- If refrigerant gas leaks during installation, ventilate the area immediately. Refrigerant gas may produce toxic gas if it comes into contact with fire. Exposure to this gas could cause severe injury or death.
- After completing the installation work, check that the refrigerant gas does not leak throughout the system.
- Do not install unit in an area where flammable materials are present due to risk of explosions that can cause serious injury or death.
- Safely dispose all packing and transportation materials in accordance with federal/state/local laws or ordinances. Packing materials such as nails and other metal or wood parts, including plastic packing materials used for transportation may cause injuries or death by suffocation.

WARNING _____

- Only qualified personnel must carry out the installation work. Installation must be done in accordance with this installation manual. Improper installation may result in water leakage, electric shock, or fire.
- When installing the unit in a small room, take measures to keep the refrigerant concentration from exceeding allowable safety limits. Excessive refrigerant leaks, in the event of an accident in a closed ambient space, can lead to oxygen deficiency.
- Use only specified accessories and parts for installation work. Failure to use specified parts may result in water leakage, electric shock, fire, or the unit falling.
- Install the air conditioner or heat pump on a foundation strong enough that it can withstand the weight of the unit. A foundation of insufficient strength may result in the unit falling and causing injuries.
- Take into account strong winds, typhoons, or earthquakes when installing. Improper installation may result in the unit falling and causing accidents.

- Make sure that a separate power supply circuit is provided for this unit and that all electrical work is carried out by qualified personnel according to local, state, and national regulations. An insufficient power supply capacity or improper electrical construction may lead to electric shock or fire.
- Make sure that all wiring is secured, that specified wires are used, and that no external forces act on the terminal connections or wires. Improper connections or installation may result in fire.
- When wiring, position the wires so that the electrical wiring box cover can be securely fastened. Improper positioning of the electrical wiring box cover may result in electric shock, fire, or the terminals overheating.
- Before touching electrical parts, turn off the unit.
- It is recommended to install a ground fault circuit interrupter if one is not already available. This helps prevent electric shock or fire.
- Securely fasten the outdoor unit terminal cover (panel). If the terminal cover/panel is not installed properly, dust or water may enter the outdoor unit causing fire or electric shock.
- When installing or relocating the system, keep the refrigerant circuit free from substances other than the specified refrigerant (R410A) such as air. Any presence of air or other foreign substance in the refrigerant circuit can cause an abnormal pressure rise or rupture, resulting in injury.
- Do not change the setting of the protection devices. If the pressure switch, thermal switch, or other protection device is shorted and operated forcibly, or parts other than those specified by Daikin are used, fire or explosion may occur.

CAUTION

- Do not touch the switch with wet fingers. Touching a switch with wet fingers can cause electric shock.
- Do not allow children to play on or around the unit to prevent injury.
- The heat exchanger fins are sharp enough to cut. To avoid injury wear gloves or cover the fins while working around them.
- Do not touch the refrigerant pipes during and immediately after operation as the refrigerant pipes may be hot or cold, depending on the condition of the refrigerant flowing through the refrigerant piping, compressor, and other refrigerant cycle parts. Your hands may suffer burns or frostbite if you touch the refrigerant pipes. To avoid injury, give the pipes time to return to normal temperature or, if you must touch them, be sure to wear proper gloves.
- Install drain piping to proper drainage. Improper drain piping may result in water leakage and property damage.
- Insulate piping to prevent condensation.
- Be careful when transporting the product.
- Do not turn off the power immediately after stopping operation. Always wait for at least 5 minutes before turning off the power. Otherwise, water leakage may occur.
- Do not use a charging cylinder. Using a charging cylinder may cause the refrigerant to deteriorate.
- Refrigerant R410A in the system must be kept clean, dry, and tight.
 - (a) Clean and Dry -- Foreign materials (including mineral oils such as SUNISO oil or moisture) should be prevented from getting into the system.



(b) Tight -- R410A does not contain any chlorine, does not destroy the ozone layer, and does not reduce the earth's protection against harmful ultraviolet radiation. R410A can contribute to the greenhouse effect if it is released. Therefore take proper measures to check for the tightness of the refrigerant piping installation. Read the chapter *Refrigerant Piping Work* and follow the procedures.

- Since R410A is a blend, the required additional refrigerant must be charged in its liquid state. If the refrigerant is charged in a state of gas, its composition can change and the system will not work properly.
- The indoor unit is for R410A. See the catalog for indoor models that can be connected. Normal operation is not possible when connected to other units.
- Remote controller (wireless kit) transmitting distance can be shorter than expected in rooms with electronic fluorescent lamps (inverter or rapid start types). Install the indoor unit far away from fluorescent lamps as much as possible.
- Indoor units are for indoor installation only. Outdoor units can be installed either outdoors or indoors. This unit is for indoor use.
- Do not install the air conditioner or heat pump in the following locations:
 - (a) Where a mineral oil mist or oil spray or vapor is produced, for example, in a kitchen. Plastic parts may deteriorate and fall off or result in water leakage.
 - (b) Where corrosive gas, such as sulfurous acid gas, is produced. Corroding copper pipes or soldered parts may result in refrigerant leakage.
 - (c) Near machinery emitting electromagnetic waves. Electromagnetic waves may disturb the operation of the control system and cause the unit to malfunction.
 - (d) Where flammable gas may leak, where there is carbon fiber, or ignitable dust suspension in the air, or where volatile flammables such as thinner or gasoline are handled. Operating the unit in such conditions can cause a fire.
- Take adequate measures to prevent the outdoor unit from being used as a shelter by small animals. Small animals making contact with electrical parts can cause malfunctions, smoke, or fire. Instruct the user to keep the area around the unit clean.

NOTE

- Install the power supply and inter-unit wires for the indoor and outdoor units at least 3.5ft away from televisions or radios to prevent image interference or noise. Depending on the radio waves, a distance of 3.5ft may not be sufficient to eliminate the noise.
- Dismantling the unit, treatment of the refrigerant, oil and additional parts must be done in accordance with the relevant local, state, and national regulations.
- Do not use the following tools that are used with conventional refrigerants: gauge manifold, charge hose, gas leak detector, reverse flow check valve, refrigerant charge base, vacuum gauge, or refrigerant recovery equipment.
- If the conventional refrigerant and refrigerator oil are mixed in R410A, the refrigerant may deteriorate.
- This air conditioner or heat pump is an appliance that should not be accessible to the general public.
- As design pressure is 478 psi, the wall thickness of field-installed pipes should be selected in accordance with the relevant local, state, and national regulations.

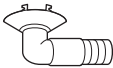
Accessories

| | | | | | |
|--|----------------|---|--|----------------|---|
| (A) Installation manual | | 1 | (B) Drain socket*  This is at the bottom of the packaging. | | 1 |
| (C) Drain cap (1)*  | 09/12 class | 4 | (D) Drain cap (2)*  | 09/12 class | 2 |
| | 15/18/24 class | 6 | | 15/18/24 class | 3 |
| (E) Warranty | | 1 | *Only for heat pump models. | | |

Precautions for Selecting a Location

- 1) Choose a place solid enough to bear the weight and vibration of the unit, where the operating sound will not be amplified.
- 2) Choose a location where the hot air discharged from the unit or the operating sound will not cause a nuisance to the neighbors of the user.
- 3) Avoid locations, such as near bedrooms, where the operating sound may cause disturbance.
- 4) There must be sufficient space to carry the unit into and out of the site.
- 5) There must be sufficient space for air passage and no obstructions around the air inlet and the air outlet.
- 6) The site must not be prone to flammable gas leaks in the surrounding area.
- 7) Install units, power cords and inter-unit wire at least 10ft (3m) away from television and radio sets. (This is to prevent interference to images and sounds. Noise may be produced even if they are more than 10ft (3m) away depending on radio wave conditions.)
- 8) In coastal areas or other places with a salty atmosphere or one containing sulfate gas, corrosion may shorten the life of the air conditioner.
- 9) Since water will flow from the drain of the outdoor unit, do not place under the unit anything which must be kept away from moisture.

NOTE

Cannot be installed suspended from a ceiling or stacked.

CAUTION

When operating the air conditioner in a low outdoor ambient temperature, be sure to follow the instructions described below.

- To prevent exposure to wind, install the outdoor unit with its suction side facing the wall.
- Never install the outdoor unit at a site where the suction side may be exposed directly to wind.
- To prevent exposure to wind, it is recommended to install a baffle plate on the air discharge side of the outdoor unit.
- In heavy snow areas, select an installation site where the snow will not affect the unit.
- If there is a likelihood of snow accumulating on the outdoor unit, attach a snow protection hood.
- In high humidity areas or heavy snow areas, it is recommended to attach a drain pan heater to prevent ice build-up from the bottom frame.

- Construct a large canopy.
- Construct a pedestal.

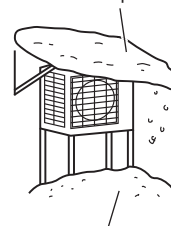

Install the unit high enough off the ground to prevent burying in snow.

Precautions on Installation

- Check the strength and level of the installation surface so that the unit does not cause any operating vibrations or noise after installation.
- Fix the unit in place securely using foundation bolts, as in the figure. (Prepare 4 sets of 5/16 inch (M8) or 3/8 inch (M10) foundation bolts, nuts and washers; all separately available.)
- It is best to screw in the foundation bolts until their ends are 3/4 inch (20mm) from the foundation surface.

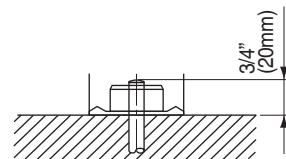

Outdoor Unit Installation Diagram

| | | | | |
|--|-----------------------------------|------------------------|--|--------------------------------|
| | RX09/12* RK09/12* RXL09/12* | RXN09/12* RKN09/12* | RX18*, RXN18* RK18*, RKN18* RXL15* | RX24*, RXN24* RK24*, RKN24* |
| Max. allowable piping length | 65-5/8ft (20m) | 49-1/4ft (15m) | 98-1/2ft (30m) | |
| ** Min. allowable piping length | 10ft (3m) | | | |
| Max. allowable piping height | 49-1/4ft (15m) | 39-3/8ft (12m) | 65-5/8ft (20m) | |
| * Additional refrigerant required for refrigerant pipe exceeding 32.8ft (10m) in length. | 0.21oz/ft (20g/m) | | | |
| Gas pipe | O.D. 3/8 inch (9.5mm) | | O.D. 1/2 inch (12.7mm) | O.D. 5/8 inch (15.9mm) |
| Liquid pipe | O.D. 1/4 inch (6.4mm) | | | |

*Be sure to add the proper amount of additional refrigerant. Failure to do so may result in reduced performance.

**The suggested shortest pipe length is 10ft (3m), in order to avoid noise from the outdoor unit and vibration. (Mechanical noise and vibration may occur depending on how the unit is installed and the environment in which it is used.)

Wrap the insulation pipe with finishing tape from bottom to top.

CAUTION
Keep the piping length between 10ft (3m) and 65-5/8ft (20m) (for RX09/12, RK09/12, RXL09/12), 10ft (3m) and 49-1/4ft (15m) (for RXN09/12, RKN09/12), 10ft (3m) and 98-1/2ft (30m) (for 15/18/24 class).

Stop valve cover
How to remove the stop valve cover
 1) Remove the screw on the stop valve cover.
 2) Slide the stop valve cover downward to remove it.
How to attach the stop valve cover
 1) Insert the upper part of the stop valve cover into the outdoor unit.
 2) Tighten the screw.

| | X | Y | Z |
|----------------|---------------------|---------------------|----------------------|
| 09/12 class | 18-1/2 inch (470mm) | 12-1/8 inch (308mm) | 3-13/16 inch (97mm) |
| 15/18/24 class | 23-5/8 inch (600mm) | 13-5/8 inch (346mm) | 4-15/16 inch (125mm) |

In sites with poor drainage, use block bases for the outdoor unit. Adjust foot height until the unit is level. Otherwise, water leakage or pooling of water may occur.

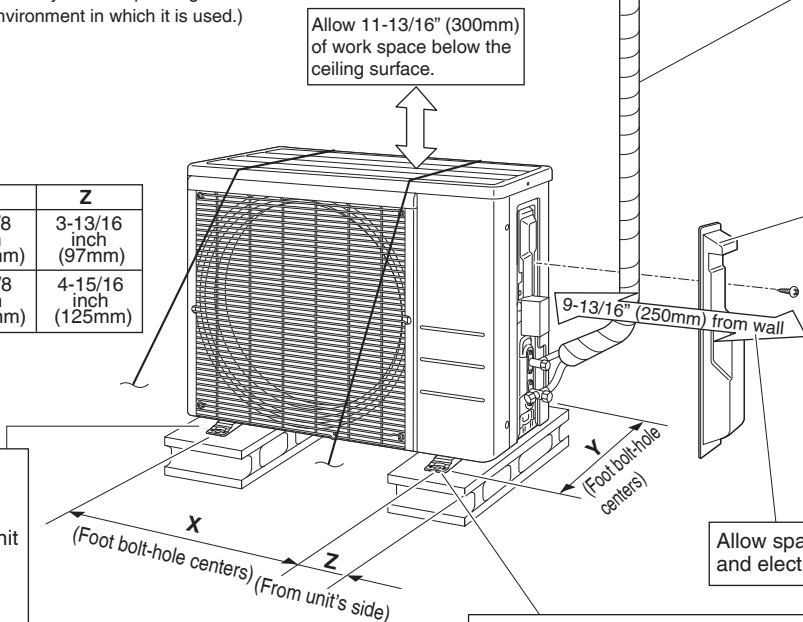

Appearance of outdoor units may differ from some models.

Installation Space Requirements

- Where a wall or other obstacle is in the path of the outdoor unit's intake or exhaust airflow, follow the installation space requirements below.
- For any of the below installation patterns, the wall height on the outlet side should be 47-1/4 inch (1200mm) or less.

09/12 class

Wall facing one side

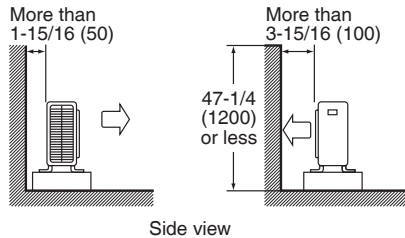

Walls facing two sides

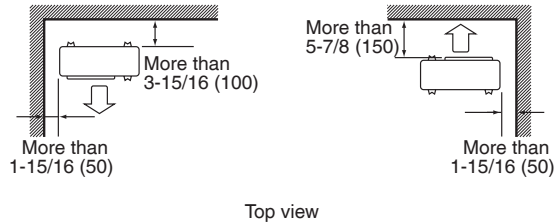

Walls facing three sides

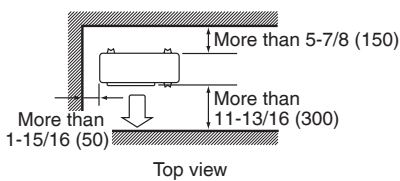

unit: inch (mm)

15/18/24 class

Wall facing one side

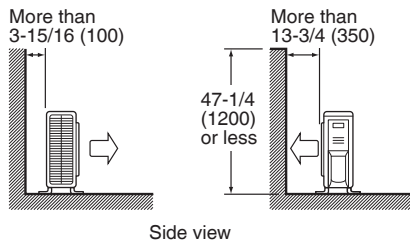

Walls facing two sides

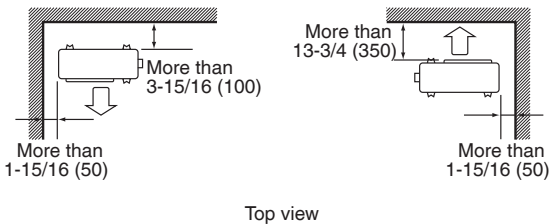

Walls facing three sides

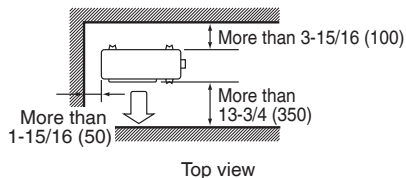

unit: inch (mm)

Outdoor Unit Installation

1. Installing the outdoor unit

- 1) When installing the outdoor unit, refer to “**Precautions for Selecting a Location**” and the “**Outdoor Unit Installation Diagram**”.
- 2) If drain work is necessary, follow the procedures on the next page.

2. Drain work (only for heat pump models, excluding RXL models)

⚠ CAUTION

In cold areas, do not use a drain socket, drain caps (1,2) and a drain hose with the outdoor unit. (Drain water may freeze, impairing heating performance.)

- If the drain port is covered by a mounting base or floor surface, place additional foot bases of at least 1-1/4 inch (30mm) in height under the outdoor unit's feet.

- Attach ③ drain cap (1) and ④ drain cap (2).
- Attach ② drain socket.
 - When attaching ② drain socket to the bottom frame, make sure to connect the drain hose to the drain socket first.

09/12 class

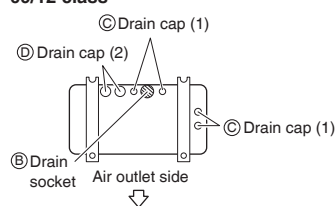

15/18/24 class

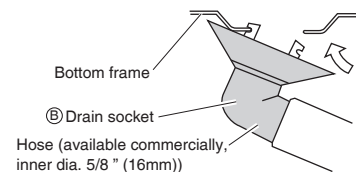
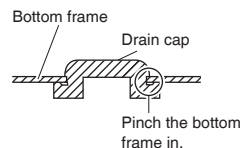
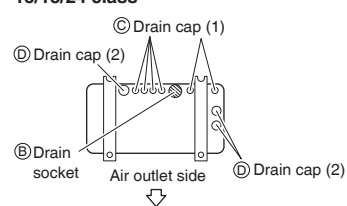

3. Flaring the pipe end

- Cut the pipe end with a pipe cutter.
- Remove burrs with the cut surface facing downward, so that the filings do not enter the pipe.
- Put the flare nut on the pipe.
- Flare the pipe.
- Check that the flaring has been done correctly.

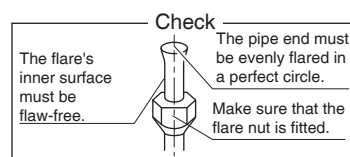
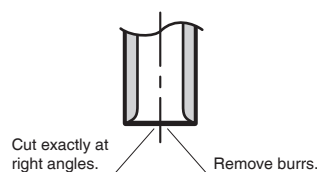

Flaring

| Set exactly at the position shown below. | | | | |
|--|------------------------|------------------------------|-------------------------------|--|
| Die | Flare tool for R410A | | Conventional flare tool | |
| | Clutch-type | Clutch-type (Rigid-type) | Wing-nut type (Imperial-type) | |
| A | 0-0.020 inch (0-0.5mm) | 0.039-0.059 inch (1.0-1.5mm) | 0.059-0.079 inch (1.5-2.0mm) | |

⚠ WARNING

- Do not apply mineral oil to the flare.
- Prevent mineral oil from getting into the system as this would reduce the service life of the units.
- Never use piping which has been used for previous installations. Only use parts which are delivered with this unit.
- Never install a dryer to this R410A unit in order to guarantee its service life.
- The drying material may dissolve and damage the system.
- Incomplete flaring may result in refrigerant gas leakage.

4. Refrigerant piping

⚠ CAUTION

- Use the flare nut fixed to the main unit. (This is to prevent the flare nut from cracking as a result of deterioration over time.)
- To prevent gas leakage, apply refrigeration oil only to the inner surface of the flare. (Use refrigeration oil for R410A.)
- Use a torque wrench when tightening the flare nuts to prevent damage to the flare nuts and gas leakage.

- Align the centers of both flares and tighten the flare nuts 3 or 4 turns by hand, then tighten them fully with a spanner and a torque wrench.

| Flare nut tightening torque | | | | |
|--|--|--|---|--|
| Gas side | | | Liquid side | |
| 3/8 inch (9.5mm) | 1/2 inch (12.7mm) | 5/8 inch (15.9mm) | 1/4 inch (6.4mm) | |
| 24-1/8 – 29-1/2ft • lbf (32.7-39.9N • m) | 36-1/2 – 44-1/2ft • lbf (49.5-60.3N • m) | 45-5/8 – 55-5/8ft • lbf (61.8-75.4N • m) | 10-1/2 – 12-3/4ft • lbf (14.2-17.2 N • m) | |
| Width across flats | 11/16 inch (17mm) | 3/4 inch (19mm) | 7/8 inch (22mm) | 1-1/16 inch (27mm) |
| Valve cap tightening torque | 10-1/2 – 12-5/8ft • lbf (14.2-17.2N • m) | 12-5/8 – 15-3/8ft • lbf (17.1-20.9N • m) | 16 – 20-1/4ft • lbf (21.6-27.4N • m) | 35-3/8 – 44-1/8ft • lbf (48-59.8N • m) |
| Service port cap tightening torque | | | | |
| 8 – 10-7/8ft • lbf (10.8-14.7N • m) | | | | |

Apply oil

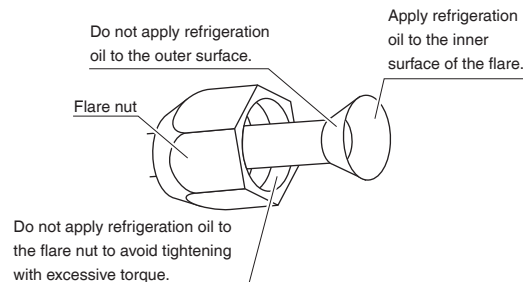

Outdoor Unit Installation

5. Pressure test and evacuating system

⚠ WARNING

- Do not mix any substance other than the specified refrigerant (R410A) into the refrigeration cycle.
- If refrigerant gas leaks should occur, ventilate the room as soon and as much as possible.
- R410A, as well as other refrigerants, should always be recovered and never be released directly into the environment.
- Use a vacuum pump for R410A exclusively. Using the same vacuum pump for different refrigerants may damage the vacuum pump or the unit.

⚠ CAUTION

It is highly recommended that you do not open/close the stop valves when the outdoor temperature is below -5°F (-21°C) as this may result in refrigerant leakage.

- When piping work is complete, it is necessary to perform a pressure test and evacuate system with a vacuum pump.
- If using additional refrigerant, purge the air from the refrigerant pipes and indoor unit using a vacuum pump, then charge additional refrigerant.
- Use a hexagonal wrench ($3/16$ inch (4mm)) to operate the stop valve rod.
- All refrigerant pipe joints should be tightened with a torque wrench to the specified tightening torque.

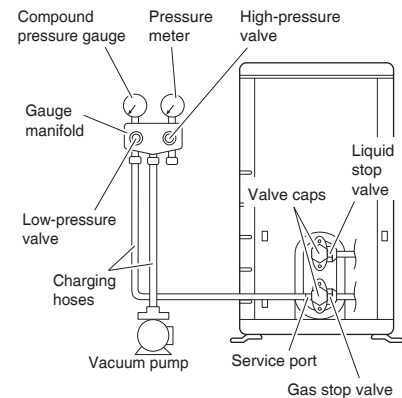

- 1) Pressurize the liquid pipe and gas pipe from the service ports of each stop valve to 550psi (3.8MPa) (do not pressurize more than 550psi (3.8MPa)) for 1 hour minimum, 24 hours recommended. If there is a pressure drop, check for leaks, make repairs and perform the pressure test again.
- 2) Connect the gauge manifold's charging hose to the gas stop valve's service port.
- 3) Fully open the gauge manifold's low-pressure valve (Lo) and completely close its high-pressure valve (Hi). (High-pressure valve will require no further operation.)
- 4) Evacuate system using vacuum pump to below 500 microns for 1 hour minimum.
- 5) Close the gauge manifold's low-pressure valve (Lo) and stop vacuum pump. (Maintain this condition for a few minutes to make sure that the compound pressure gauge pointer does not swing back.)*¹
- 6) Remove the valve caps from the liquid stop valve and gas stop valve.
- 7) Turn the liquid stop valve's rod 90° counter-clockwise with a hexagonal wrench to open the valve. Close it after 5 seconds, and check for gas leakage. Using soapy water, check for gas leakage from the indoor unit's flare and outdoor unit's flare and valve rods. After the check is complete, wipe all soapy water off.
- 8) Disconnect the charging hose from the gas stop valve's service port, then fully open the liquid and gas stop valves. (Do not attempt to turn the valve rod further than it can go.)
- 9) Tighten the valve caps and service port caps for the liquid and gas stop valves with a torque wrench to the specified torques. Refer to "4. Refrigerant piping" on page 6 for details.

*¹ If the compound pressure gauge pointer swings back, the refrigerant may have water content or there may be a loose pipe joint. Check all pipe joints and retighten nuts as needed, then repeat steps 3) through 5).

6. Refilling refrigerant

Check the type of refrigerant to be used on the machine nameplate.

Precautions when adding R410A

Fill from the liquid pipe in liquid form.

R410A is a mixed refrigerant, so adding it in gas form may cause the refrigerant composition to change, preventing normal operation.

- 1) Before filling, check whether the cylinder has a siphon attached or not. (It should have something like "liquid filling siphon attached" displayed on it.)

Filling a cylinder with an attached siphon



Stand the cylinder upright when filling.

(There is a siphon pipe inside, so the cylinder need not be upside-down to fill with liquid.)

Filling other cylinders



Turn the cylinder upside-down when filling.

- Be sure to use the R410A tools to ensure pressure and to prevent foreign objects entering.

7. Refrigerant piping work

7-1. Cautions on pipe handling

- Protect the open end of the pipe from dust and moisture.
- All pipe bends should be as gentle as possible. Use a pipe bender for bending.

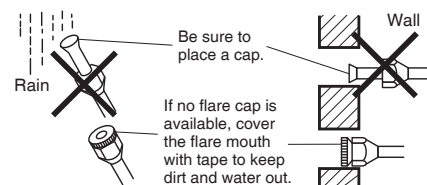

7-2. Selection of copper and heat insulation materials

When using commercial copper pipes and fittings, observe the following:

- Insulation material: Polyethylene foam
Heat transfer rate: 0.041 to 0.052W/mK (0.024 to 0.030Btu/ft^h°F (0.035 to 0.045kcal/mh°C))
Be sure to use insulation that is designed for use with HVAC Systems.
- ACR Copper only.
- Be sure to insulate both the gas and liquid piping and observe the insulation dimensions as below.

| | Piping size | Minimum bend radius | Piping thickness | Thermal insulation size | Thermal insulation thickness |
|-------------|------------------------|-----------------------------|-------------------------------|---------------------------------|------------------------------|
| Gas side | O.D. 3/8 inch (9.5mm) | 1-3/16 inch (30mm) or more | 0.031 inch (0.8mm) (C1220T-O) | I.D. 15/32-19/32 inch (12-15mm) | 13/32 inch (10mm) Min. |
| | O.D. 1/2 inch (12.7mm) | 1-9/16 inch (40mm) or more | | I.D. 9/16-5/8 inch (14-16mm) | |
| | O.D. 5/8 inch (15.9mm) | 1-15/16 inch (50mm) or more | 0.039 inch (1.0mm) (C1220T-O) | I.D. 5/8-13/16 inch (16-20mm) | |
| Liquid side | O.D. 1/4 inch (6.4mm) | 1-3/16 inch (30mm) or more | 0.031 inch (0.8mm) (C1220T-O) | I.D. 5/16-13/32 inch (8-10mm) | |

- Use separate thermal insulation pipes for gas and liquid refrigerant pipes.

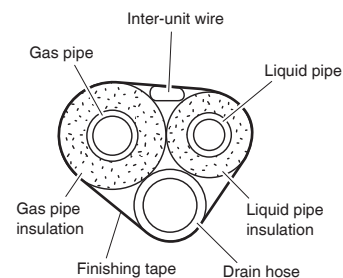

Wiring

⚠ WARNING

- Do not use tapped wires, extension cords, or starburst connections, as they may cause overheating, electric shock, or fire.
- Do not use locally purchased electrical parts inside the product. (Do not branch the power for the drain pump, etc., from the terminal block.) Doing so may cause electric shock or fire.
- Be sure to install a ground fault circuit interrupter. (One that can handle higher harmonics.)
(This unit uses an inverter. Therefore, a ground fault circuit interrupter capable of handling higher harmonics must be used in order to prevent the ground fault circuit interrupter malfunctioning.)
- Use an all-pole disconnection type circuit breaker with at least 1/8 inch (3mm) between the contact point gaps.
- When carrying out wiring, take care not to pull at the conduit.
- Do not connect the power wire to the indoor unit. Doing so may cause electric shock or fire.

- Do not turn on the circuit breaker until all work is completed.
 - 1) Strip the insulation from the wire (3/4 inch (20mm)).
 - 2) Connect the inter-unit wires between the indoor and outdoor units so that the terminal numbers match. Tighten the terminal screws securely. It is recommended that a flathead screwdriver be used to tighten the screws. The screws are packed with the terminal block.

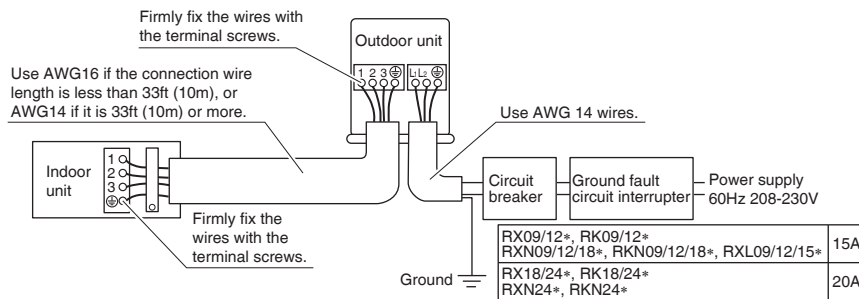

09/12 class

[Method of mounting conduit]

- A protection plate is fixed for protection from the high-voltage section.
 - 1) Dismount the stop valve cover by removing the screw.
 - 2) Dismount the protection plate by removing the 2 screws.
 - 3) Dismount the conduit mounting cover by removing the 2 screws.
 - 4) Pass wires through the conduit and secure them with a lock nut.
 - 5) After completing the work, reattach the stop valve cover, the conduit mounting cover, and the protection plate to its original position.

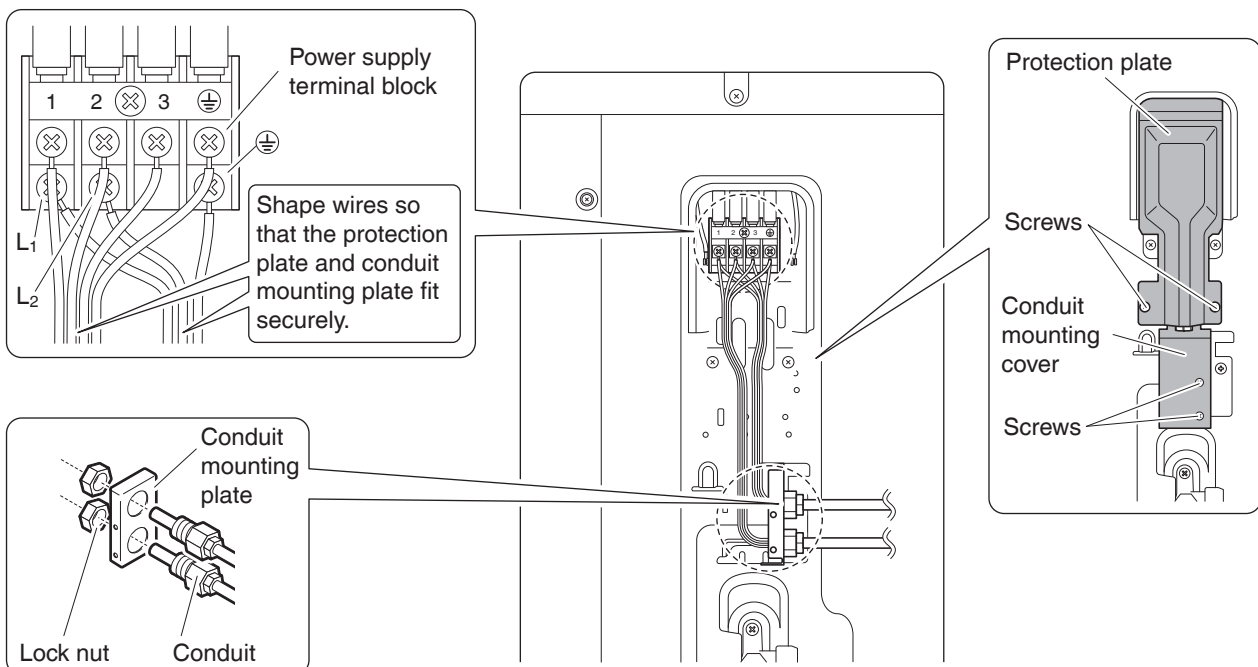

15/18/24 class

[Method of mounting conduit]

- 1) Dismount the service lid by removing the 2 screws.
- 2) Pass wires through the conduit and secure them with a lock nut.
- 3) After completing the work, reattach the service lid to its original position.

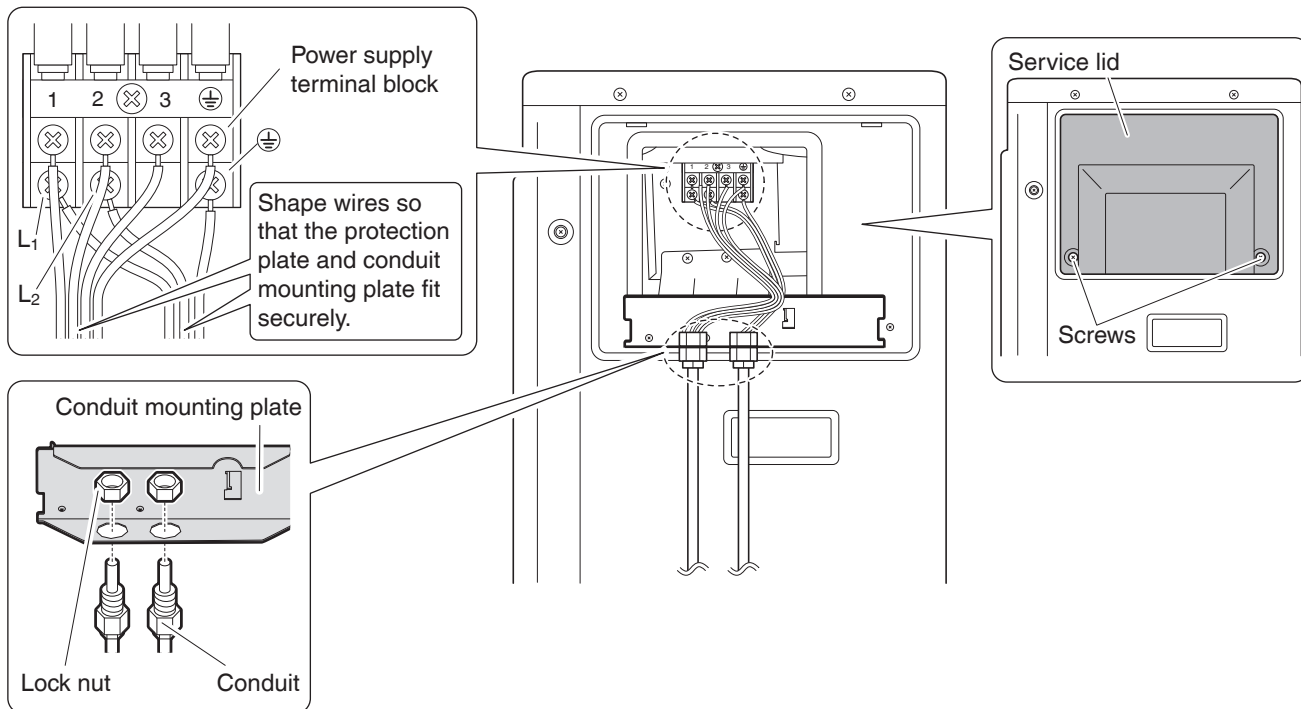

CAUTION

Precautions to be taken for power supply wiring

- When using stranded wires, make sure to use the round crimp-style terminal for connection to the power supply terminal block.

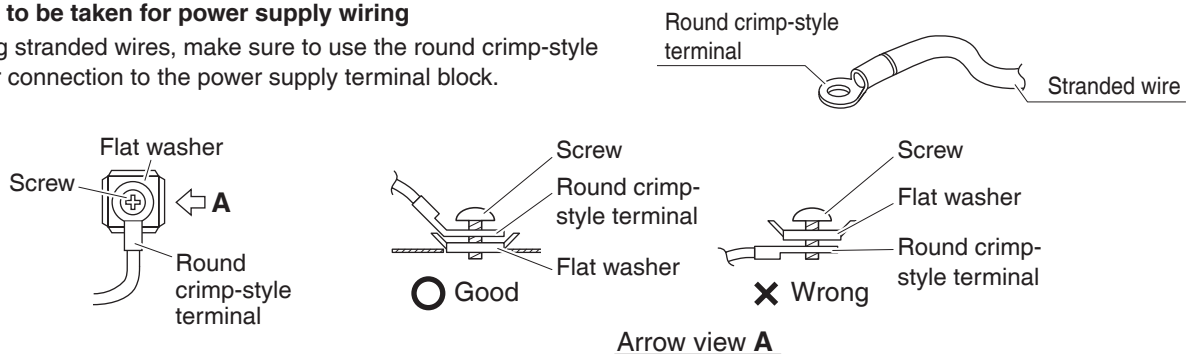

- When connecting the inter-unit wires to the terminal block using a single core wire, be sure to curl the end of the lead. Improper work may cause heat and fires.

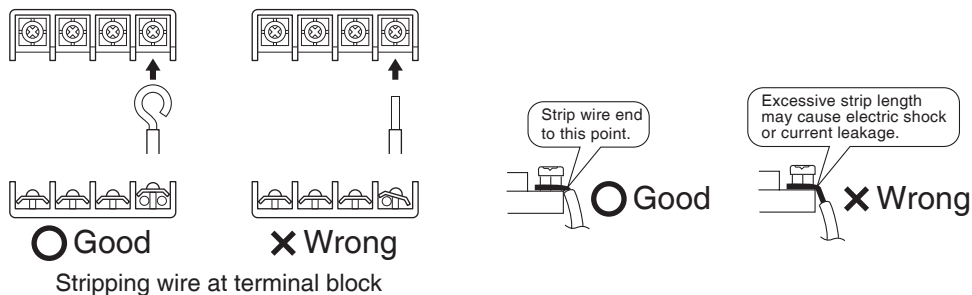

Facility Setting* (cooling at low outdoor temperature)

This function is limited only for facilities (the target of air conditioning is equipment (such as computer)).
Never use it in a residence or office (the space where there is a human).

*Only for RX, RK, and RXL models.

- Cutting jumper 6 (J6) on the circuit board will expand the operation range down to 5°F (–15°C). However it will stop if the outdoor temperature drops below –4°F (–20°C) and start back up once the temperature rises again.

- 1) Remove the top plate of the outdoor unit. (09/12 class: 3 screws, 15/18/24 class: 6 screws)
- 2) Remove the front plate. (09/12 class: 4 screws, 15/18/24 class: 8 screws)
- 3) Cut the jumper (J6) of the PCB inside.

⚠ CAUTION

- If the outdoor unit is installed where the heat exchanger of the unit is exposed to direct wind, provide a windbreak wall.
- Intermittent noises may be produced by the indoor unit due to the outdoor fan turning on and off when using facility settings.
- Do not place humidifiers or other items which might raise the humidity in rooms where facility settings are being used. A humidifier might cause dew jumping from the indoor unit outlet vent.
- Cutting jumper 6 (J6) sets the indoor fan tap to the highest position. Notify the user about this.

Pump Down Operation

In order to protect the environment, be sure to pump down when relocating or disposing of the unit.

- 1) Remove the valve cap from the liquid stop valve and gas stop valve.
- 2) Carry out forced cooling operation.
- 3) After 5 to 10 minutes, close the liquid stop valve with a hexagonal wrench.
- 4) After 2 to 3 minutes, close the gas stop valve and stop forced cooling operation.

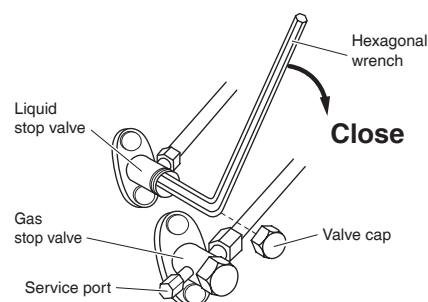

Forced cooling operation

■Using the indoor unit ON/OFF switch

Press the indoor unit ON/OFF switch for at least 5 seconds. (The operation will start.)

- Forced cooling operation will stop automatically after about 15 minutes. To stop the operation, press the indoor unit ON/OFF switch.

■Using the indoor unit's remote controller

[For wall mounted units]

- 1) Press **TEMP** (F/C), **TEMP** (F/C), and **OFF** at the same time.
 - 2) Press **TEMP** (F/C), then select **7**, press **FAN**.
 - 3) Press **COOL** to turn on the system.
- Forced cooling operation will stop automatically after about 30 minutes. To stop the operation, press **OFF**.

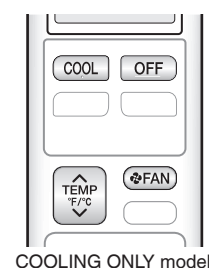

[For floor standing units]

- 1) Press **Mode** and select the COOL operation.
- 2) Press **On/Off** to turn on the system.
- 3) Press **Temp** (F/C), **Temp** (F/C), and **Mode** at the same time.
- 4) Press **Temp** (F/C), select "7", and press **Mode** for confirmation.

- Forced cooling operation will stop automatically after about 30 minutes. To stop the operation, press **On/Off**.



⚠ CAUTION

- When pressing the switch, do not touch the terminal block. It has a high voltage, and touching it could cause electric shock.

Trial Operation and Testing

1. Trial operation and testing

- Trial operation should be carried out in either COOL or HEAT operation.

1-1. Measure the supply voltage and make sure that it is within the specified range.

1-2. In COOL operation, select the lowest programmable temperature; in HEAT operation, select the highest programmable temperature.

1-3. Carry out the trial operation following the instructions in the operation manual to ensure that all functions and parts, such as the movement of the flap, are working properly.

- To protect the air conditioner, restart operation is disabled for 3 minutes after the system has been turned off.

1-4. After trial operation is complete, set the temperature to a normal level (78°F to 82°F (26°C to 28°C) in COOL operation, 68°F to 75°F (20°C to 24°C) in HEAT operation).

- When operating the air conditioner in COOL operation in winter, or HEAT operation in summer, activate trial operation mode by following the instructions in the installation manual for the indoor unit.
- The air conditioner draws a small amount of power in its standby mode. If the system is not to be used for some time after installation, shut off the circuit breaker to eliminate unnecessary power consumption.
- If the circuit breaker trips to shut off the power to the air conditioner, the system will restore the original operation mode when the circuit breaker is opened again.

2. Test items

| Test items | Symptom | Check |
|---|-------------------------------------|-------|
| Indoor and outdoor units are installed properly on solid bases. | Fall, vibration, noise | |
| No refrigerant gas leaks. | Incomplete cooling/heating function | |
| Refrigerant gas and liquid pipes and indoor drain hose extension are thermally insulated. | Water leakage | |
| Draining line is properly installed. | Water leakage | |
| System is properly grounded. | Electrical leakage | |
| The specified wires are used for inter-unit wiring. | No operation or burn damage | |
| Indoor or outdoor unit's air inlet or air outlet are unobstructed. | Incomplete cooling/heating function | |
| Stop valves are opened. | Incomplete cooling/heating function | |
| Indoor unit properly receives remote control commands. | No operation | |

GOODMAN MANUFACTURING COMPANY, L.P.

5151 San Felipe, Suite 500
Houston, TX 77056 USA

DAIKIN INDUSTRIES, LTD.

Head office:
Umeda Center Bldg., 2-4-12, Nakazaki-Nishi,
Kita-ku, Osaka, 530-8323 Japan

Tokyo office:
JR Shinagawa East Bldg., 2-18-1, Konan,
Minato-ku, Tokyo, 108-0075 Japan
<http://www.daikin.com>



Two-dimensional bar code
is a manufacturing code.

3P379970-6B

M15B135 (1511) HT