



SIUS04-921



Service Manual

Inverter Pair Wall Mounted Type H-Series



- [Applied Models]
● Inverter Pair : Heat Pump

Inverter Pair Wall Mounted Type H-Series

● Heat Pump

Indoor Units

FTXG09HVJU
FTXG12HVJU
FTXG15HVJU

Outdoor Units

RXG09HVJU
RXG12HVJU
RXG15HVJU

1. SAFETY CONSIDERATIONS.....	vi
-------------------------------	----

Part 1

List of Functions	1
--------------------------------	----------

1. Functions.....	2
-------------------	---

Part 2

Specifications	3
-----------------------------	----------

1. Specifications	4
-------------------------	---

Part 3

Printed Circuit Board

Connector Wiring Diagram	7
---------------------------------------	----------

1. Printed Circuit Board Connector Wiring Diagram.....	8
--	---

1.1 Indoor Unit.....	8
----------------------	---

1.2 Outdoor Unit	10
------------------------	----

Part 4

Function and Control..... 11

1. Description of Operation	12
1.1 Indoor Unit.....	12
1.2 Outdoor Unit.....	13
2. Main Functions.....	14
2.1 QUATERNITY Drying Operation.....	14
2.2 Comfort Sleep Operation.....	16
2.3 Automatic Operation.....	18
2.4 Comfort Airflow Mode.....	19
2.5 Cooling Breeze Operation.....	20
2.6 Power-airflow Dual FlapsFins.....	21
2.7 Wide-angle LouversFins.....	21
2.8 3-D Airflow.....	22
2.9 POWERFUL Operation	23
2.10 Indoor Unit Quiet Operation	23
2.11 Multi-colored Indicator Lamp	24
2.12 Monitor Brightness Setting	24
2.13 Information Display.....	25
2.14 Mold-Proof Stick.....	26
2.15 FLASH STREAMER AIR PURIFYING Operation	27
2.16 Wipe-clean Flat Panel	29
2.17 Filter Cleaning Indicator (Remote Controller).....	30
2.18 TIMER Operation	30
2.19 Night Set Mode.....	31
2.20 Table for Special Modes.....	32
2.21 Thermostat Control.....	33
2.22 Fan Speed Control for Indoor Units.....	34
2.23 Draft Prevention (Hot-Start).....	36
3. Control Specification	37
3.1 Frequency Control.....	37
3.2 Preheating Operation (Quick Warming Function)	38
3.3 Four Way Valve Operation	38
3.4 Compressor Start-up Protection.....	39
3.5 Fan Speed Control for Outdoor Unit.....	40
3.6 Fin Thermistor Control.....	41
3.7 Input Current Control.....	41
3.8 Peak-cut Control.....	42
3.9 Indoor Heat Exchanger Freeze-up Protection.....	43
3.10 Dew Prevention	44
3.11 Liquid Compression Protection 2	45
3.12 Discharge Pipe Temperature Control.....	45
3.13 Automatic Defrosting.....	46
3.14 Electronic Expansion Valve Control	47

Part 5**System Configuration..... 53**

1. Installation Manual	54
1.1 Indoor Units	54
1.2 Outdoor Units	64
2. System Configuration	70
3. Instruction.....	71
3.1 Remote Controller	71
3.2 Cooling · QUATERNITY DRYING Operation	73
3.3 Heating Operation	74
3.4 AUTO Operation.....	75
3.5 FLASH STREAMER AIR PURIFYING · POWERFUL Operation	76
3.6 Adjusting Airflow Direction · Airflow Rate	77
3.7 COMFORT AIRFLOW · COOLING BREEZE Operation	78
3.8 TIMER Operation	79
3.9 COMFORT SLEEP Operation.....	80
3.10 SET UP · CHILD PROOF LOCK	81
3.11 INFORMATION DISPLAY	82

Part 6**Service Diagnosis..... 83**

1. Convenient Service Check Function	85
2. Troubleshooting	87
2.1 Error Code Indication by Remote Controller	87
2.2 Air conditioner does not run.	88
2.3 Air conditioner runs but does not cool or heat	91
2.4 When operation starts, safety breaker trips.....	93
2.5 Air conditioner makes a loud sound and vibrates.....	95
2.6 Indoor Unit PCB Abnormality	96
2.7 Peak-cut Control or Freeze-up Protection.....	97
2.8 Fan Motor System (DC Motor) Abnormality	99
2.9 Streamer Unit Abnormality	101
2.10 Thermistor System Abnormality	103
2.11 Front Panel Open / Close Abnormality	104
2.12 Humidity Sensor Abnormality	105
2.13 Signal Transmission Error (Indoor Unit - Outdoor Unit)	106
2.14 Incompatible Power Supply between Indoor Unit and Outdoor Unit	108
2.15 Outdoor Unit PCB Abnormality.....	109
2.16 OL Activation (Compressor Overload)	110
2.17 Compressor Lock	111
2.18 DC Fan Lock	112
2.19 Input Overcurrent Detection	113
2.20 Four-Way Valve Abnormality.....	115
2.21 Discharge Pipe Temperature Control.....	117
2.22 High Pressure Control in Cooling	118

2.23	Compressor Sensor System Abnormality	120
2.24	Position Sensor Abnormality	121
2.25	DC Voltage / DC Current Sensor Abnormality	123
2.26	Thermistor System Abnormality	124
2.27	Abnormal Temperature in Electrical Box	126
2.28	Temperature Rise in Radiation Fin.....	128
2.29	Output Overcurrent.....	130
2.30	Insufficient Gas.....	132
2.31	Over Voltage Protection / Low Voltage Protection	134
2.32	Outdoor Unit PCB Abnormality or Communication Circuit Abnormality.....	135
2.33	Signal Transmission Error on Outdoor Unit PCB	138
2.34	Lights-out of Microcomputer Status Lamp.....	140
3.	Check	141
3.1	Thermistor Resistance Check	141
3.2	Installation Condition Check.....	142
3.3	Outdoor Fan System Check (DC Motor)	142
3.4	Power Supply Waveform Check.....	143
3.5	Main Circuit Electrolytic Capacitor Check	143
3.6	Refrigerant System Check	144
3.7	“Inverter Checker” Check	145
3.8	Power Transistor Check.....	146
3.9	Discharge Pressure Check.....	147
3.10	Electronic Expansion Valve Check.....	148
3.11	Indoor Unit PCB Output Check	149
3.12	Rotating Pulse Input on Outdoor Unit PCB Check.....	150
3.13	Humidity Sensor Check.....	151
3.14	Main Circuit Short Check.....	151
3.15	Four-Way Valve Performance Check.....	152
3.16	Solenoid Valve for Dehumidification Check	153

Part 7

Removal Procedure 155

1.	Indoor Unit.....	156
1.1	Removal of Air Filters / Front panel.....	156
1.2	Removal of Upper Panel	163
1.3	Removal of Front Grille	166
1.4	Removal of Assembly of Open/Close Mechanism	169
1.5	Removal of Assembly of Reduction Motor	171
1.6	Removal of Electrical Box	174
1.7	Removal of PCB.....	179
1.8	Removal of Dehumidifying Solenoid Valve Coil	185
1.9	Removal of Drain Hose	186
1.10	Removal of Swing Motor	188
1.11	Removal of Heat Exchanger	190
1.12	Removal of Propeller Fan / Fan Motor	193
1.13	Removal of Horizontal Blades / Vertical Blades	196
1.14	Removal of Streamer Unit.....	199

2. Outdoor Unit.....	203
2.1 How to Check the Service Monitor (LED A)	203
2.2 Removal of Propeller Fan / Fan Motor	205
2.3 Removal of Electrical Box	210
2.4 Removal of PCB.....	214
2.5 Removal of Sound Blanket.....	218
2.6 Removal of Thermistor Assembly	220
2.7 Removal of Reactor / Partition Plate	222
2.8 Removal of Four Way Valve.....	224
2.9 Removal of the Expansion Valve	226
2.10 Removal of Compressor.....	228

Part 8

Others Additional Information 231

1. Additional Information	232
1.1 Trial Operation.....	232
1.2 Field Setting	233
1.3 Application of Silicon Grease to a Power Transistor and a Diode Bridge.....	234

Part 9

Appendix..... 235





1. Piping Diagrams.....	236
1.1 Indoor Units	236
1.2 Outdoor Units	236
2. Wiring Diagrams.....	237
2.1 Indoor Units	237
2.2 Outdoor Units	237

Index i

1. SAFETY CONSIDERATIONS

Read these **SAFETY CONSIDERATIONS** carefully before performing any repair work. Comply with these safety symbols without fail.

Meanings of **DANGER**, **WARNING**, **CAUTION**, and **NOTE** Symbols:

-  **DANGER** Indicates an imminently hazardous situation which, if not avoided, will result in death or serious injury.
-  **WARNING** Indicates a potentially hazardous situation which, if not avoided, could result in death or serious injury.
-  **CAUTION** Indicates a potentially hazardous situation which, if not avoided, may result in minor or moderate injury. It may also be used to alert against unsafe practices.
-  **NOTE** Indicates situations that may result in equipment or property-damage only.

1.1 Safety Considerations for Repair

DANGER

- If refrigerant gas leaks during repair or service, ventilate the area immediately. Refrigerant gas may produce toxic gas if it comes into contact with flames. Refrigerant gas is heavier than air and replaces oxygen. In the event of an accident, a massive leak could lead to oxygen depletion, especially in basements, and an asphyxiation hazard could occur leading to serious injury or death.
- Do not start or stop the air conditioner operation by plugging or unplugging the power cable plug if a plug is used. Plugging or unplugging the power cable plug to operate the equipment may cause an electrical shock or fire.
- Use parts listed in the service parts list and appropriate tools to conduct repair work. The use of inappropriate parts or tools may cause an electrical shock or fire.
- Disconnect power before disassembling the equipment for repairs. Working on the equipment that is connected to the power supply may cause an electric shock. If it is necessary to supply power to the equipment to conduct repairs or to inspect the circuits, do not touch any electrically charged sections of the equipment.
- The step-up capacitor supplies high-voltage electricity to the electrical components of the outdoor unit. Discharge the capacitor completely before conducting repair work. A charged capacitor may cause an electrical shock.

- If refrigerant gas is discharged during repair work, do not touch the discharged refrigerant gas. The refrigerant gas may cause frostbite.
 - Use only pipes, flare nuts, tools, and other materials designed specifically for R410A refrigerant systems. Never use tools or materials designed for R22 refrigerant systems on an R410A refrigerant system. Doing so can cause a serious accident or an equipment failure.
 - Check to see if the parts and wires are mounted and connected properly, and if the connections at the soldered or crimped terminals are secure. Improper installation and connections may cause excessive heat generation, fire, or electrical shock.
- ### **WARNING**
- Prior to disconnecting the suction or discharge pipe from the compressor at the welded section, pump-down the refrigerant gas completely in a well-ventilated place first. If there is refrigerant gas or oil remaining inside the compressor, the refrigerant gas or oil can discharge when the pipe is being disconnected and it may cause an injury.
 - Wear a safety helmet, gloves, and a safety belt when working at an elevated height of more than 6.5 ft (2 m). Insufficient safety measures may cause a fall resulting in injury.
 - Do not mix air or gas other than the specified refrigerant R410A to the refrigerant system. If air enters the refrigerant systems, it can cause an excessive high pressure resulting in equipment damage and injury.
 - When relocating the equipment, check if the new installation site has sufficient strength to withstand the weight of the equipment. If the installation site does not have sufficient strength and the equipment is not properly secured, the equipment may fall and cause injury.
 - Securely fasten the outside unit terminal cover (panel). If the terminal cover/panel is not fastened properly, dust or water may enter the outside unit causing fire or electric shock.
 - When relocating the system, keep the refrigerant circuit free from substances other than the specified refrigerant (R-410A) such as air. Any presence of air or other foreign substance in the refrigerant circuit can cause an abnormal pressure rise or rupture, resulting in injury.
 - If refrigerant gas leaks, locate the leaking point and repair it before charging refrigerant. After charging refrigerant, check for refrigerant leaks. If the leaking point cannot be located and the repair work must be stopped, perform a pump-down and close the service valve to prevent the refrigerant gas from

leaking into the room. The refrigerant gas itself is harmless, but it may generate toxic gases if it comes into contact with flames.

 CAUTION

- Do not repair the electrical components with wet hands. Working on the equipment with wet hands may cause an electrical shock.
- Do not clean the air conditioner by splashing water on it. Washing the unit with water may cause an electrical shock.
- Ground the unit when repairing equipment in a humid or wet place to avoid electrical shocks.
- Turn off the power when cleaning the equipment to prevent internal fans that rotate at high speed from starting suddenly as they can cause injury.
- Let the refrigerant lines cool down before performing any repair work. Working on the unit when the refrigerant lines are hot may cause burns.
- All welding and cutting operations must be done in a well-ventilated place to prevent the accumulation of toxic fumes or possibly oxygen deficiency to occur.
- Check the grounding and repair it if the equipment is not properly grounded. Improper grounding may cause an electrical shock.
- Measure the insulation resistance after the repair.
The resistance must be 1M Ω or higher. Faulty insulation may cause an electrical shock.

 NOTE

- Check the drainage of the indoor unit after finishing repair work. Faulty drainage may cause water to enter the room resulting in wet floors and furniture.
- Do not tilt the unit when removing it. The water inside the unit may spill resulting in wet floors and furniture.
- Dismantling of the unit, disposal of the refrigerant, oil, and additional parts, should be done in accordance with the relevant local, state, and national regulations.

1.2 Safety Considerations for Users

 DANGER

- Never attempt to modify the equipment. Doing so can cause electrical shock, excessive heat generation, or fire.
- If the power cable and lead wires have scratches or have become deteriorated, have them replaced. Damaged cable and wires may cause an electrical shock or fire.

- Do not use a joined power cable or an extension cord, or share the same power outlet with other electrical appliances as it may cause an electrical shock or fire.

- Use an exclusive power circuit for the equipment. Insufficient circuit amperage capacity may cause an electrical shock or fire.

 WARNING

- Do not damage or modify the power cable. Damaged or modified power cables may cause an electrical shock or fire. Placing heavy items on the power cable or pulling the power cable may damage the cable.
- Check the unit foundation for damage on a continual basis, especially if it has been in use for a long time. If left in a damaged condition, the unit may fall and cause injury. If the installation platform or frame has corroded, have it replaced. A corroded platform or frame may cause the unit to fall resulting in injury.
- If the unit has a power cable plug and it is dirty, clean the plug before securely inserting it into a power outlet. If the plug has a loose connection, tighten it or it may cause electrical shock or fire.

 CAUTION

- After replacing the battery in the remote controller, dispose of the old battery to prevent children from swallowing it. If a child swallows the battery, see a doctor immediately.
- Never remove the fan guard of the unit. A fan rotating at high speed without the fan guard is very dangerous.
- Before cleaning the unit, stop the operation of the unit by turning the power off or by pulling the power cable plug out from its receptacle. Otherwise an electrical shock or injury may result.
- Do not wipe the controller operation panel with benzene, thinner, chemical dust cloth, etc. The panel may get discolored or the coating can peel off. If it is extremely dirty, soak a cloth in a water-diluted neutral detergent, squeeze it well, and wipe the panel clean. Then wipe it with another dry cloth.

Part 1

List of Functions

1. Functions.....2

1. Functions

Category	Functions	FTXG09/12/15HVJU RXG09/12/15HVJU	Category	Functions	FTXG09/12/15HVJU RXG09/12/15HVJU	
Basic Function	Inverter (with Inverter Power Control)	○	Health & Clean	Air-Purifying Filter	—	
	Operation Limit for Cooling (°FDB)	14~109		Photocatalytic Deodorizing Filter	—	
	Operation Limit for Heating (°FWB)	-4~75		Air-Purifying Filter with Photocatalytic Deodorizing Function	—	
	PAM Control	○		Titanium Apatite Photocatalytic Air-Purifying Filter	○	
	Energy Saving During Operation Standby	—		Deodorizing Filter for Streamer	○	
Compressor	Oval Scroll Compressor	—	Flash Streamer Air-Purifying	○		
	Swing Compressor	○	Air Filter (Pre-filter)	○		
	Rotary Compressor	—	Wipe-clean Flat Panel	○		
	Reluctance DC Motor	○	Washable Upper Grille	○		
Comfortable Airflow	Power-Airflow Flap	—	Filter Cleaning Indicator (Remote Controller)	○		
	Power-Airflow Dual Flaps	○	Mold Proof Operation	—		
	Wide-Angle Louvers	○	Mold Shock Operation	—		
	Vertical Auto-Swing (Up and Down)	○	Mold-Proof Stick	○		
	Horizontal Auto-Swing (Right and Left)	○	Comfort Sleep Operation	○★2		
	3-D Airflow	○	Fresh Air Supply Ventilation	—		
	Comfort Airflow Mode	○	Home Leave Ventilation	—		
	COOLING BREEZE Operation	○	Weekly Timer	—		
Comfort Control	Auto Fan Speed	○	Timer	24-Hour ON/OFF Timer	○	
	Indoor Unit Quiet Operation	○		Count Up-down ON/OFF Timer	OFF only	
	Night Quiet Mode (Automatic)	—		Night Set Mode	○	
	Outdoor Unit Quiet Operation (Manual)	—		Worry Free "Reliability & Durability"	Auto-Restart (after Power Failure)	○
	INTELLIGENT EYE	—	Self-Diagnosis (Remote Controller) Display		○	
	2-Area INTELLIGENT EYE	—	Wiring Error Check		—	
	Quick Warming Function	○	Anticorrosion Treatment of Outdoor Heat Exchanger		○	
	Hot-Start Function	○	Flexibility	Multi-Split / Split Compatible Indoor Unit	—	
Automatic Defrosting	○	H/P, C/O Compatible Indoor Unit		—		
Operation	Automatic Operation	○		Chargeless	○	
		—		Either Side Drain (Right or Left)	○	
	QUATERNITY Drying Operation	—	Power Selection	—		
	DRY COOLING Operation	○	Low Temperature Cooling Operation (-15°C (5°F))	—		
	Program Dry Function	—	°C/°F changeover R/C temperature display (factory setting : °F)	○★3		
	Fan Only	—	Remote Control	5-Rooms Centralized Controller (Option)	○	
	Air-Purifying Operation	○		Remote Control Adaptor (Normal Open-Pulse Contact) (Option)	○	
Lifestyle Convenience	New POWERFUL Operation (Non-Inverter)	—		Remote Control Adaptor (Normal Open Contact) (Option)	○	
	Inverter POWERFUL Operation	○★1 ★2		DIII-NET Compatible (Adaptor) (Option)	○	
	Dry Keep	JP set		Remote Controller	Wireless	○
	Priority-Room Setting	—			Wired	—
	Cooling / Heating Mode Lock	—				
	HOME LEAVE Operation	—				
	ECONO Mode	—				
	Indoor Unit ON/OFF Switch	○				
	Signal Reception Indicator	○				
	Multi-colored Indicator	○				
	Monitor Brightness Setting	○				
	Temperature & Humidity Level Information Display (Remote Controller)	○				
	Childproof Lock	○				
R/C with Back Light	—					

Note: ○ : Included Functions
— : No Functions

(★1) Inverter POWERFUL operation can be used for COOLING, DRY COOLING, and HEATING.

(★2) The function setting is cancelled as it is restarted automatically.

(★3) Temperature display -9°C-37°C(16-99°F)

Part 2 Specifications

1. Specifications4

1. Specifications

60Hz 230V

Models	Indoor Units		FTXG09HVJU		FTXG12HVJU	
	Outdoor Units		RXG09HVJU		RXG12HVJU	
			Cooling	Heating	Cooling	Heating
Capacity Rated (Min.-Max.)	Btu/h		9,000 (5,300-12,300)	12,000 (4,400-18,000)	12,000 (5,300-15,700)	16,000 (4,400-19,100)
Moisture Removal	Pt/h		3.3	—	4.1	—
Running Current (Rated)	A		3.10	4.04	4.30	5.64
Power Consumption Rated (Min.-Max.)	W		570 (250-900)	780 (220-1,900)	860 (260-1,300)	1,160 (220-2,100)
Power Factor	%		80.0	84.0	87.0	89.5
EER (Rated)	Btu/h-W		15.8	—	14.0	—
COP (Rated)	W/W		4.6	4.5	4.1	4.0
Energy Efficiency	SEER/HSPF		26.1	11.0	24.2	10.6
Piping Connections	Liquid	inch (mm)	φ1/4" (6.4 mm)		φ1/4" (6.4 mm)	
	Gas	inch (mm)	φ3/8" (9.5 mm)		φ3/8" (9.5 mm)	
	Drain	inch (mm)	φ 11/16" (17.5 mm)		φ 11/16" (17.5 mm)	
Heat Insulation			Both Liquid and Gas Pipes		Both Liquid and Gas Pipes	
Max. Interunit Piping Length	feet (m)		32 ft (9.8 m)		32 ft (9.8 m)	
Max. Interunit Height Difference	feet (m)		26 ft (8 m)		26 ft (8 m)	
Chargeless			—		—	
Amount of Additional Charge of Refrigerant	oz/ft		—		—	
Indoor Units			FTXG09HVJU		FTXG12HVJU	
Front Panel Color			White		White	
Airflow Rate	cfm (m ³ /min)	H	420 (11.9)	438 (12.4)	459 (13.0)	470 (13.3)
		M	325 (9.2)	346 (9.8)	346 (9.8)	367 (10.4)
		L	230 (6.5)	258 (7.3)	240 (6.8)	272 (7.7)
Fan	Type		Cross Flow Fan		Cross Flow Fan	
	Motor Output	W	57		57	
	Speed	Steps	5 Steps, Quiet and Auto		5 Steps, Quiet and Auto	
Air Direction Control			Right, Left, Horizontal and Downward		Right, Left, Horizontal and Downward	
Air Filter			Removable / Washable / Mildew Proof		Removable / Washable / Mildew Proof	
Running Current (Rated)	A		0.12	0.14	0.14	0.15
Power Consumption (Rated)	W		24	26	29	31
Power Factor	%		87	80.7	90.1	89.9
Temperature Control			Microcomputer Control		Microcomputer Control	
Dimensions (HxWxD)	inch (mm)		12 x 35-1/16 x 8-1/4" (305 x 891 x 210 mm)		12 x 35-1/16 x 8-1/4" (305 x 891 x 210 mm)	
Packaged Dimensions (HxWxD)	inch (mm)		11 x 37-5/8 x 14-7/8" (279 x 956 x 378 mm)		11 x 37-5/8 x 14-7/8" (279 x 956 x 378 mm)	
Weight	Lbs (kg)		31 lbs (14 kg)		31 lbs (14 kg)	
Gross Weight	Lbs (kg)		38 lbs (17 kg)		38 lbs (17 kg)	
Operation Sound	H/M/L	dBA	42 / 33 / 26	42 / 35 / 28	43 / 35 / 27	43 / 36 / 29
Outdoor Units			RXG09HVJU		RXG12HVJU	
Casing Color			Ivory White		Ivory White	
Compressor	Type		Hermetically Sealed Swing Type		Hermetically Sealed Swing Type	
	Model		2YC36CXD		2YC36CXD	
	Motor Output	W	1,100		1,100	
Refrigerant Oil	Type		FVC50K		FVC50K	
	Charge	oz	13.5		13.5	
Refrigerant	Type		R-410A		R-410A	
	Charge	Lbs	3.1		3.1	
Airflow Rate	cfm (m ³ /min)	H	1,178 (33.4)	1,095 (31.0)	1,262 (35.7)	1,111 (31.5)
		L	—	—	—	—
Fan	Type		Propeller		Propeller	
	Motor Output	W	60		60	
Running Current (Rated)	A		2.98	3.9	4.16	5.49
Power Consumption (Rated)	W		546	754	831	1,129
Power Factor	%		79.7	84.1	86.9	89.4
Dimensions (HxWxD)	inch (mm)		22-3/8 x 31-5/16 x 11-1/4" (568 x 795 x 286 mm)		22-3/8 x 31-5/16 x 11-1/4" (568 x 795 x 286 mm)	
Packaged Dimensions (HxWxD)	inch (mm)		25-3/16 x 36-7/16 x 14-7/8" (640 x 926 x 378 mm)		25-3/16 x 36-7/16 x 14-7/8" (640 x 926 x 378 mm)	
Weight	Lbs (kg)		99 lbs (45 kg)		99 lbs (45 kg)	
Gross Weight	Lbs (kg)		104 lbs (47 kg)		104 lbs (47 kg)	
Operation Sound	H / L	dBA	46 / —	46 / —	49 / —	48 / —
Drawing No.			3D062857		3D062858	

Note: ■ The data are based on the conditions shown in the table below.

Cooling	Heating	Piping Length
Indoor ; 80°FDB/67°F WB Outdoor ; 95°FDB/75°F WB	Indoor ; 70°FDB/60°F WB Outdoor ; 47°FDB/43°F WB	25 ft (7.5 m)

Conversion Formulae
kcal/h=kWx860 Btu/h=kWx3414 cfm=m ³ /minx35.3

60Hz 230V

Model	Indoor Units		FTXG15HVJU	
	Outdoor Units		RXG15HVJU	
			Cooling	Heating
Capacity Rated (Min.~Max.)	Btu/h	15,000 (5,300~18,000)		18,000 (4,400~21,200)
Moisture Removal	Pt/h	4.8		—
Running Current (Rated)	A	5.64		6.36
Power Consumption Rated (Min.~Max.)	W	1,160 (260~1,930)		1,320 (230~2,120)
Power Factor	%	89.0		99.0
EER (Rated)	Btu/h-W	12.9		—
COP (Rated)	W/W	3.8		4.0
Energy Efficiency	SEER/HSPF	21.0		10.0
Piping Connections	Liquid	inch (mm)	φ1/4" (6.4 mm)	
	Gas	inch (mm)	φ3/8" (9.5 mm)	
	Drain	inch (mm)	φ 11/16" (17.5 mm)	
Heat Insulation	Both Liquid and Gas Pipes			
Max. Interunit Piping Length	feet (m)	32 ft (10 m)		
Max. Interunit Height Difference	feet (m)	26 ft (8 m)		
Chargeless	—			
Amount of Additional Charge of Refrigerant	oz/ft	—		
Indoor Unit		FTXG15HVJU		
Front Panel Color	White			
Airflow Rate	cfm (m³/min)	H	487 (13.8)	494 (14.0)
		M	371 (10.5)	392 (11.1)
		L	258 (7.3)	293 (8.3)
Fan	Type	Cross Flow Fan		
	Motor Output	W 57		
	Speed	Steps 5 Steps, Quiet, Auto		
Air Direction Control	Right, Left, Horizontal, Downward			
Air Filter	Removable / Washable / Mildew Proof			
Running Current (Rated)	A	0.15	0.16	
Power Consumption (Rated)	W	33	35	
Power Factor	%	95.7	95.1	
Temperature Control	Microcomputer Control			
Dimensions (HxWxD)	inch (mm)	12 x 35-1/16 x 8-1/4" (305 x 891 x 210 mm)		
Packaged Dimensions (HxWxD)	inch (mm)	11 x 37-5/8 x 14-7/8" (279 x 956 x 378 mm)		
Weight	Lbs (kg)	31 lbs (14 kg)		
Gross Weight	Lbs (kg)	38 lbs (17 kg)		
Operation Sound	H/M/L	dBA	45 / 37 / 29	44 / 38 / 31
Outdoor Unit		RXG15HVJU		
Casing Color	Ivory White			
Compressor	Type	Hermetically Sealed Swing Type		
	Model	2YC36CXD		
	Motor Output	W 1,100		
Refrigerant Oil	Model	FVC50K		
	Charge	oz 13.5		
Refrigerant	Model	R-410A		
	Charge	Lbs 3.1		
Airflow Rate	cfm (m³/min)	H	1,262 (35.7)	1,195 (33.8)
		L	—	—
Fan	Type	Propeller		
	Motor Output	W 60		
Running Current (Rated)	A	5.49	6.2	
Power Consumption (Rated)	W	1,127	1,285	
Power Factor	%	89.3	90.1	
Dimensions (HxWxD)	inch (mm)	22-3/8 x31-5/16 x11-1/4" (568 x 795 x 286 mm)		
Packaged Dimensions (HxWxD)	inch (mm)	25-3/16 x 36-7/16 x 14-7/8" (640 x 926 x 378 mm)		
Weight	Lbs (kg)	99 lbs (45 kg)		
Gross Weight	Lbs (kg)	104 lbs (47 kg)		
Operation Sound	H / L	dBA	50 / —	50 / —
Drawing No.	3D062859			

Note: ■ The data are based on the conditions shown in the table below.

Cooling	Heating	Piping Length
Indoor ; 80°FDB/67°FWB Outdoor ; 95°FDB/75°FWB	Indoor ; 70°FDB/60°FWB Outdoor ; 47°FDB/43°FWB	25 ft (7.5 m)

Conversion Formulae
kcal/h=kWx860 Btu/h=kWx3414 cfm=m³/minx35.3

Part 3

Printed Circuit Board Connector Wiring Diagram

1. Printed Circuit Board Connector Wiring Diagram.....	8
1.1 Indoor Unit.....	8
1.2 Outdoor Unit.....	10

1. Printed Circuit Board Connector Wiring Diagram

1.1 Indoor Unit

Connectors

A1P (Control PCB)

- | | |
|--------|---|
| 1) S1 | Connector for fan motor |
| 2) S21 | Connector for centralized control (HA) |
| 3) S32 | Connector for heat exchanger thermistor (R1T) |
| 4) S41 | Connector for swing motor (horizontal, vertical) |
| 5) S43 | Connector for solenoid valve |
| 6) S46 | Connector for display PCB |
| 7) S48 | Connector for humidity sensor PCB |
| 8) S51 | Connector for reduction motor, limit switch (front panel) |
| 9) S52 | Connector for streamer unit |

A2P (Display PCB)

- | | |
|--------------|---|
| 1) S56 | Connector for control PCB |
| 2) S57 | Connector for signal receiver / transmitter PCB |
| 3) S63 (H1P) | Connector for LED PCB (multi monitor) |

A3P (Signal Receiver/Transmitter PCB)

- | | |
|--------|---------------------------|
| 1) S58 | Connector for display PCB |
|--------|---------------------------|

A4P (Humidity Sensor PCB)

- | | |
|--------|---------------------------|
| 1) CN1 | Connector for control PCB |
|--------|---------------------------|

A5P (Streamer Unit PCB)

- | | |
|---------|---|
| 1) S401 | Connector for control PCB |
| 2) S402 | Connector for limit switch for streamer |
| 3) S403 | Connector for streamer |



Note: Other designations

A1P (Control PCB)

- | | |
|----------|--|
| 1) V1 | Varistor |
| 2) FU1 | Fuse (3.15A) |
| 3) LED A | LED for service monitor (green) |
| 4) JB | Fan speed setting when compressor is OFF on thermostat |
| JC | Power failure recovery function (auto-restart) |
- *Refer to page 233 for details.

A2P (Display PCB)

- | | |
|--------------|----------------------------------|
| 1) JA | Address setting jumper |
| 2) SW1 (S1W) | Forced operation ON / OFF switch |
| 3) LED2 | LED for timer (orange) |

A4P (Humidity Sensor PCB)

- | | |
|--------|-----------------------------|
| 1) R2T | Room temperature thermistor |
|--------|-----------------------------|

PCB Detail

PCB(1): Control PCB

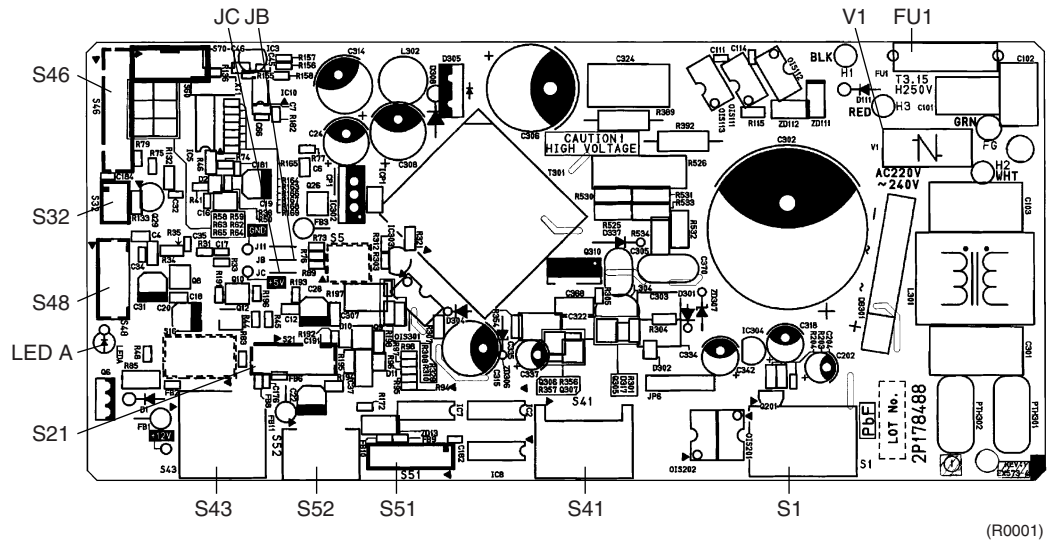

PCB(2): Display PCB

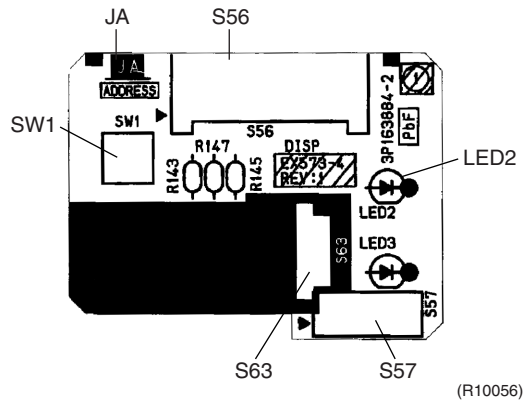

PCB(3): Signal Receiver / Transmitter PCB

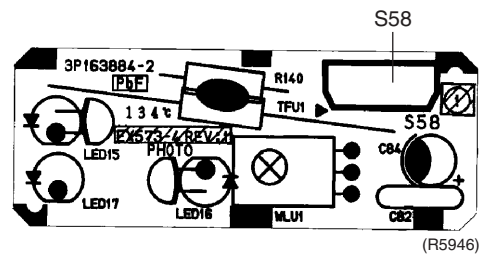

PCB(4): Humidity sensor PCB

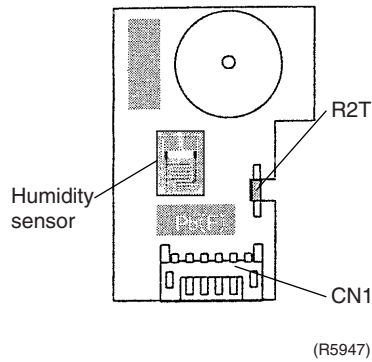

PCB(5): Streamer Unit PCB

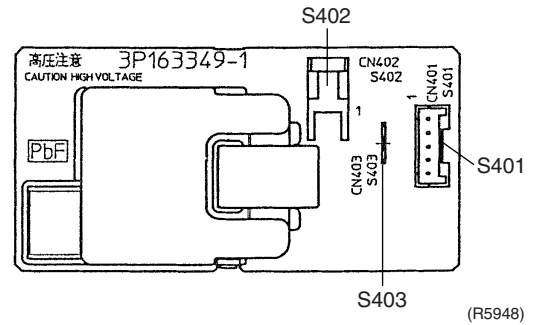

1.2 Outdoor Unit

Connectors

- 1) S20 Connector for electronic expansion valve coil
- 2) S45 Connector for thermal fuse
- 3) S70 Connector for DC fan motor
- 4) S80 Connector for four-way valve coil
- 5) S90 Connector for thermistor (outdoor, heat exchanger, discharge pipe)

i Note:

Other designations

- 1) FU1, FU2 Fuse (3.15A)
- 2) FU3 Fuse (30A)
- 3) V1, V2 Varistor
- 4) LED A LED for service monitor (green)
- 5) LED5 LED for inverter (green)

PCB Detail

PCB(1): Control PCB

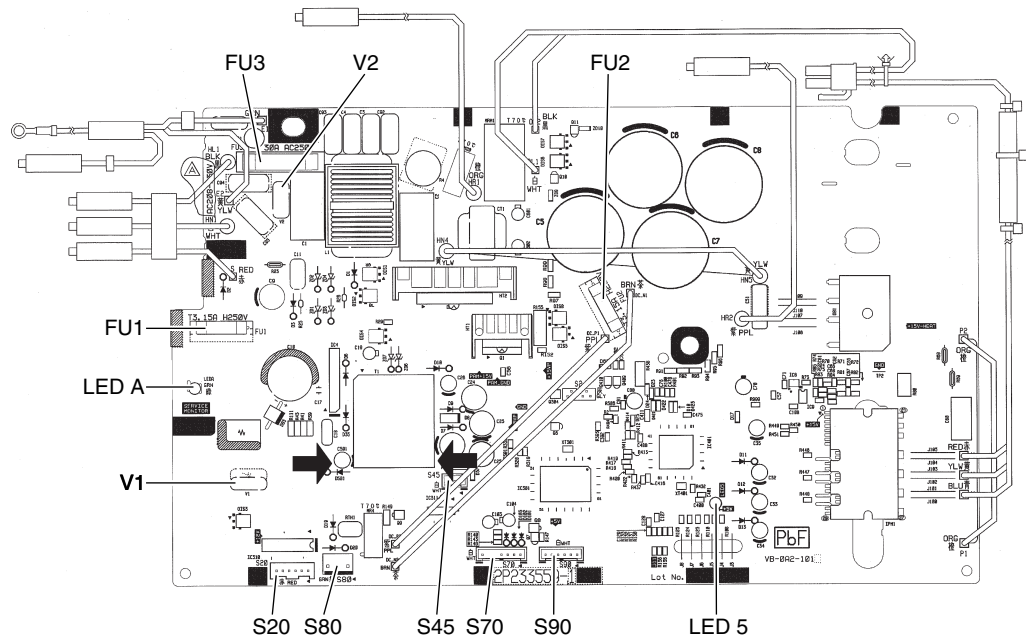

(R10057)

Part 4

Function and Control

1. Description of Operation	12
1.1 Indoor Unit.....	12
1.2 Outdoor Unit.....	13
2. Main Functions.....	14
2.1 QUATERNITY Drying Operation.....	14
2.2 Comfort Sleep Operation.....	16
2.3 Automatic Operation.....	18
2.4 Comfort Airflow Mode.....	19
2.5 Cooling Breeze Operation.....	20
2.6 Power-airflow Dual Flaps	21
2.7 Wide-angle Louvers	21
2.8 3-D Airflow.....	23
2.9 POWERFUL Operation	23
2.10 Indoor Unit Quiet Operation	24
2.11 Multi-colored Indicator Lamp.....	24
2.12 Monitor Brightness Setting	25
2.13 Information Display.....	25
2.14 Mold-Proof Stick.....	26
2.15 FLASH STREAMER AIR PURIFYING Operation	27
2.16 Wipe-clean Flat Panel	29
2.17 Filter Cleaning Indicator (Remote Controller).....	30
2.18 TIMER Operation	30
2.19 Night Set Mode.....	31
2.20 Table for Special Modes.....	32
2.21 Thermostat Control.....	33
2.22 Fan Speed Control for Indoor Units.....	34
2.23 Draft Prevention (Hot-Start).....	36
3. Control Specification	37
3.1 Frequency Control.....	37
3.2 Preheating Operation (Quick Warming Function)	38
3.3 Four-Way Valve Operation.....	38
3.4 Compressor Start-up Protection.....	39
3.5 Fan Speed Control for Outdoor Unit.....	40
3.6 Fin Thermistor Control.....	41
3.7 Input Current Control.....	41
3.8 Peak-cut Control.....	42
3.9 Indoor Heat Exchanger Freeze-up Protection.....	43
3.10 Dew Prevention	44
3.11 Liquid Compression Protection 2	45
3.12 Discharge Pipe Temperature Control.....	45
3.13 Automatic Defrosting.....	46
3.14 Electronic Expansion Valve Control	47

1. Description of Operation

1.1 Indoor Unit

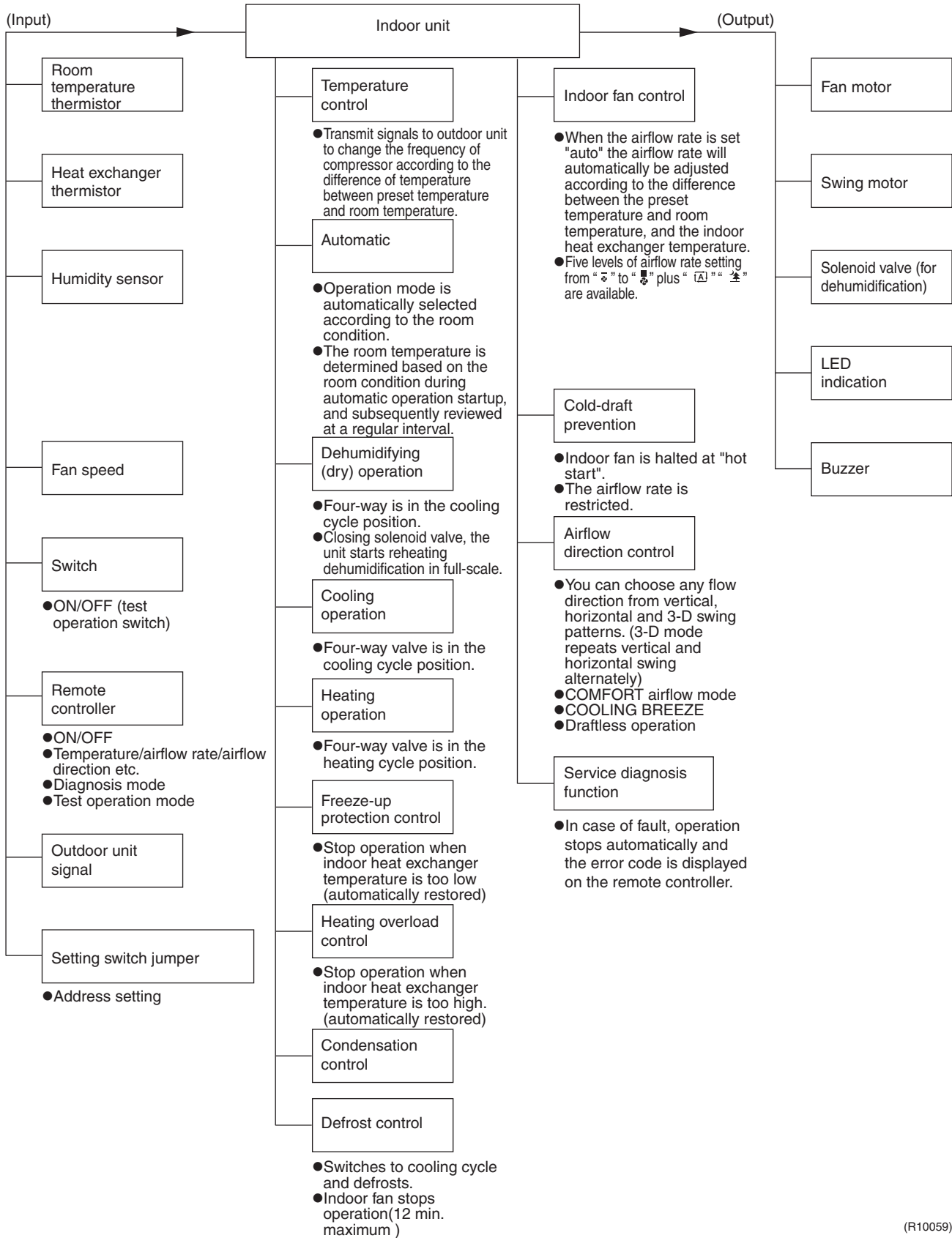

(R10059)

1.2 Outdoor Unit

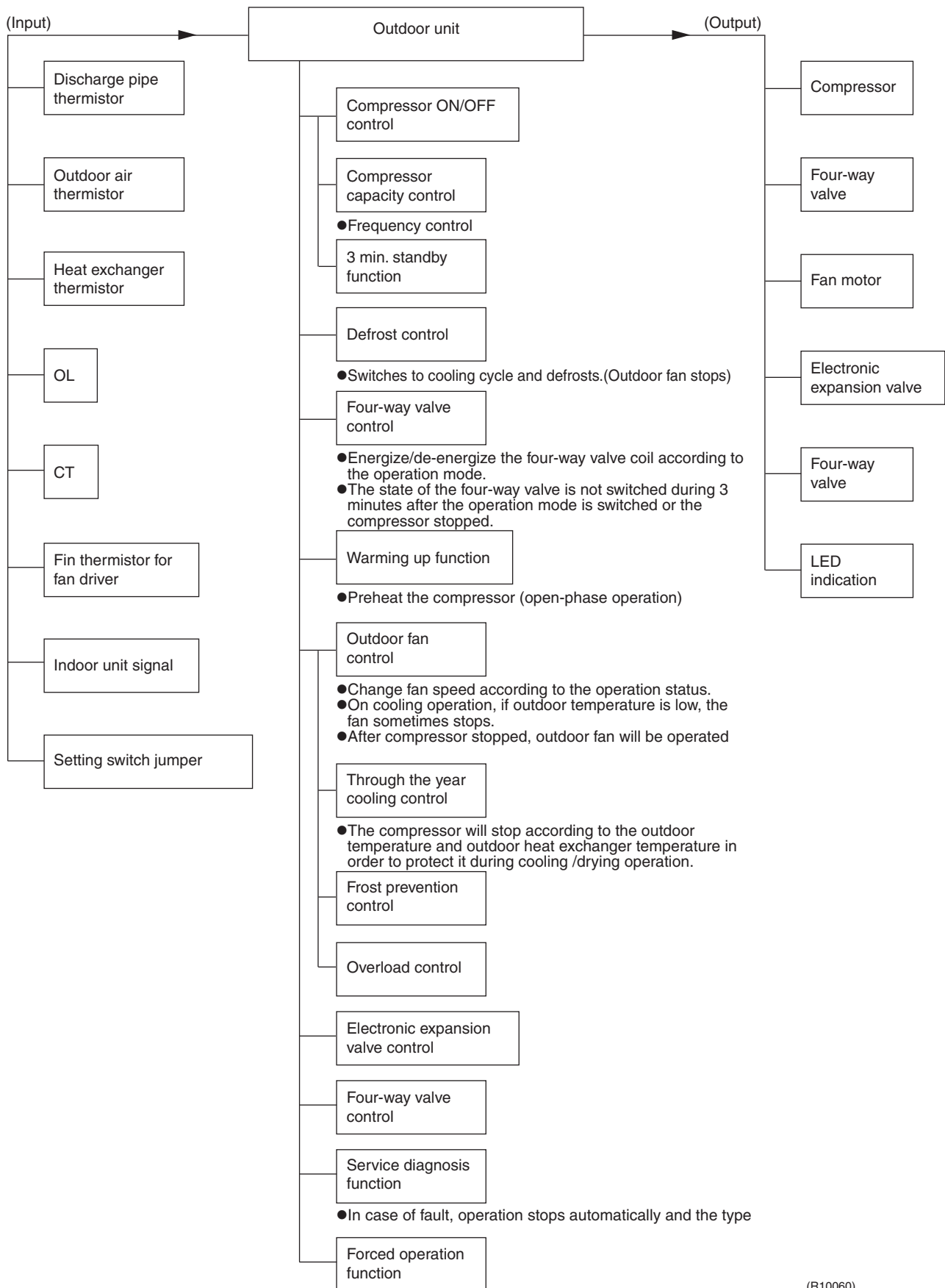

(R10060)

2. Main Functions

2.1 QUATERNITY Drying Operation

Operation

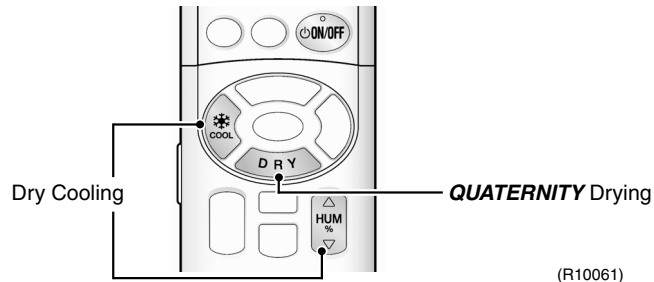

(R10061)

* Refer to the operation manual for details.

Features

■ **Reheating dehumidifying method is applied.**

Powerful evaporator eliminates the humidity in your room exclusively. Dry cool air is mixed with warm air from the reheater, thereby blowing in optimal and comfortable dry air.

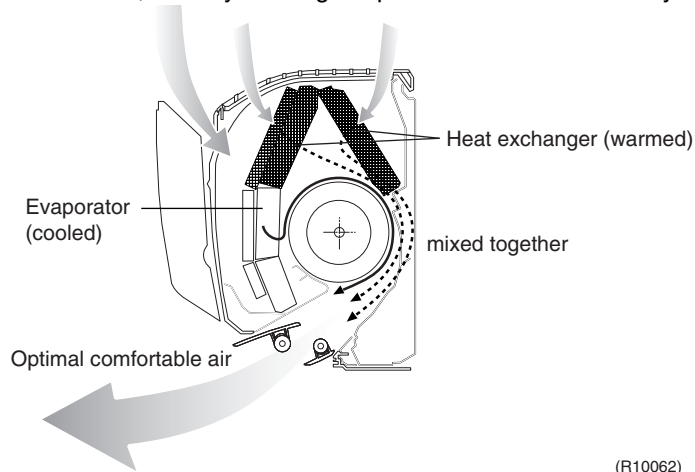

(R10062)

■ **Adjustable humidity even during full cooling**

It is comfortable even with moderate cooling because you can adjust the indoor humidity to your preference. Decreasing the temperature difference between the conditioned space and outside reduces the perception of it being too cold. It is recommended for those sensitive to cooling as well as a means to energy savings.

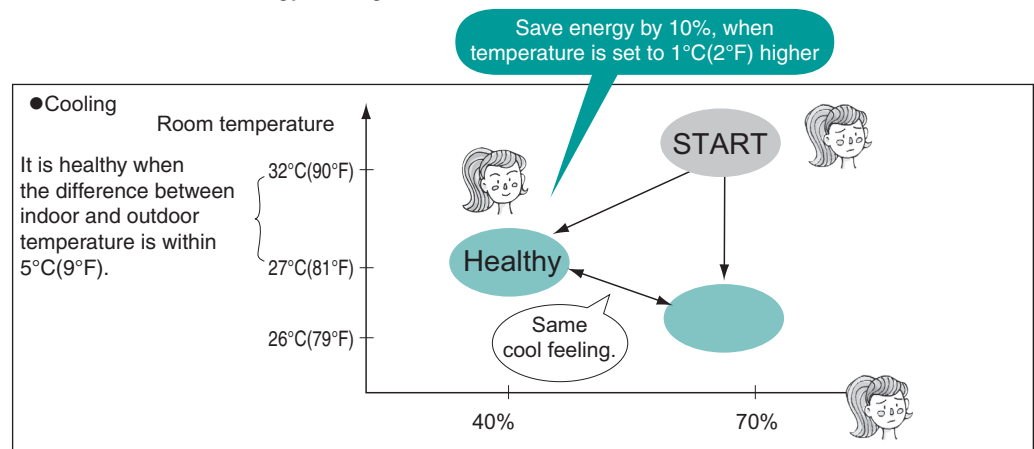

(R10063)

■ Differences on *QUANTERNITY* drying and "dry cooling" operation

	<i>QUANTERNITY</i> Drying	Dry Cooling
Method	<p>Puts a pressure reducing device (solenoid valve) in the center of the heat exchanger of indoor unit to separate it into upper and lower side. The upper side acts as a condenser to heat the air.</p> <p>The lower heat exchanger performs the usual Dry Cooling Operation to make low-temperature and low-humidity air.</p> <p>Both types of air are mixed to make moderate-temperature and low-humidity air for blowing.</p>	<p>As is the cooling mechanism, the Dry Cooling Operation raises latent heat capacity with controlling sensible heat capacity by adjusting the compressor frequency and indoor airflow rate.</p>
Case by case use for dehumidification and cooling dehumidification	<p>As this is a reheating method, it is recommended to eliminate humidity without lowering room temperature if possible (this is recommended when cooling load is small).</p>	<p>The dry cooling does not use a reheating method. In order to eliminate humidity, it is recommended to use at the set temperature lowered by several degrees from the room temperature at operation startup (this is recommended when cooling load is large).</p>
Mechanism		
Humidity adjusting method	<p>Adjust by operation frequency of the compressor.</p> <p>When operation frequency increases, humidity falls, and when the frequency decreases, humidity fall is suppressed.</p>	<p>Adjust by operation frequency of the compressor and indoor airflow rate.</p> <p>When operation frequency increases and indoor airflow rate decreases, the humidity falls. When operation frequency decreases and the airflow rate increases, humidity fall is suppressed.</p>
Room temperature adjusting method	<p>Adjust by outdoor airflow rate.</p> <p>When outdoor airflow rate increases, room temperature falls, and when it decreases, room temperature fall is suppressed.</p>	<p>Adjust by operation frequency of the compressor.</p> <p>When operation frequency increases, the room temperature falls, and when operation frequency decreases, the room temperature fall is suppressed.</p>
Thermostat OFF condition	<p>When room temperature falls.</p> <ul style="list-style-type: none"> Room temp. \leq preset temp. $-2.5^{\circ}\text{C}(4.5^{\circ}\text{F})$ or Room temp. \approx preset temp. and the humidity is lower than target humidity (lower by more than 5%). 	<p>When room temperature falls.</p> <ul style="list-style-type: none"> Room temp. \leq preset temp. $-2.0^{\circ}\text{C}(3.6^{\circ}\text{F})$ or Preset temp. $-1.5^{\circ}\text{C}(2.7^{\circ}\text{F}) <$ room temp. \leq preset temp. $-1.0^{\circ}\text{C}(1.8^{\circ}\text{F})$ continues for 10 min.
Thermostat OFF \rightarrow ON condition	<p>When thermostat OFF condition is not satisfied</p>	<ul style="list-style-type: none"> Room temp. \geq preset temp. $-0.5^{\circ}\text{C}(0.9^{\circ}\text{F})$ or Preset temp. $-1.5^{\circ}\text{C}(2.7^{\circ}\text{F}) <$ room temp. \leq preset temp. $-1.0^{\circ}\text{C}(1.8^{\circ}\text{F})$ continues for 10 min.
Time to reach the target humidity	<p>Approx. 1 hour consecutive as a standard (depending on the conditions)</p>	<p>Approx. 1 hour consecutive as a standard (depending on the conditions)</p>
Remarks (FAQ)	<p>The humidity does not decrease.</p> <p>According to the load conditions of your room, the temperature sometimes falls and thermostat ON/OFF repeats. As a result, the room may not be dehumidified enough. Set the temperature lower.</p>	<p>The humidity does not decrease. (Thermostat ON/OFF are repeated.)</p> <p>As the reheating method is not used, if you set the temperature close to the room temperature, thermostat ON/OFF are repeated according to the load conditions of the room. As a result, the room may not be dehumidified enough. In cooling dehumidification mode, set the temperature lower than the room temperature by several degrees. If you do not want to lower the room temperature too much, the reheating dehumidification operation method is recommended.</p>

2.2 Comfort Sleep Operation

Operation

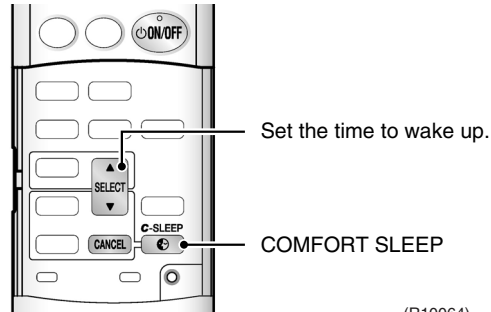

(R10064)

- Effective mode for COMFORT SLEEP operation
 - Cooling
 - Dry cooling
 - Heating

* Refer to the operation manual for details.

Features

- Outline of function

The temperature is controlled in unique V-shape pattern within the range of about 2°C (3.6°F) upper and lower. First the room temperature is gradually lowered at the beginning of sleep to induce the lowering of body temperature in sleeping.

Then, the room temperature is kept constant, and when the preset wake-up time approaches, the room temperature is gradually raised to induce the raising of body temperature before waking.
- V-shape pattern temperature control system
 - The air conditioner controls the room temperature showing V-shape pattern.

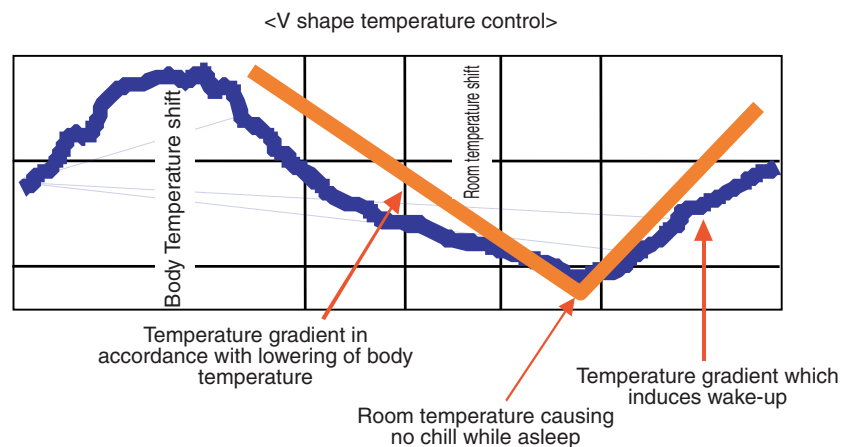

(R5089)

Change in body temperature in human sleep is controlled in ideal V-shape pattern by the air conditioner's temperature control.

(Reference: Control system adopted for JAL First Class flight)

- Human sleep
 - Sleep cycle and change in body temperature

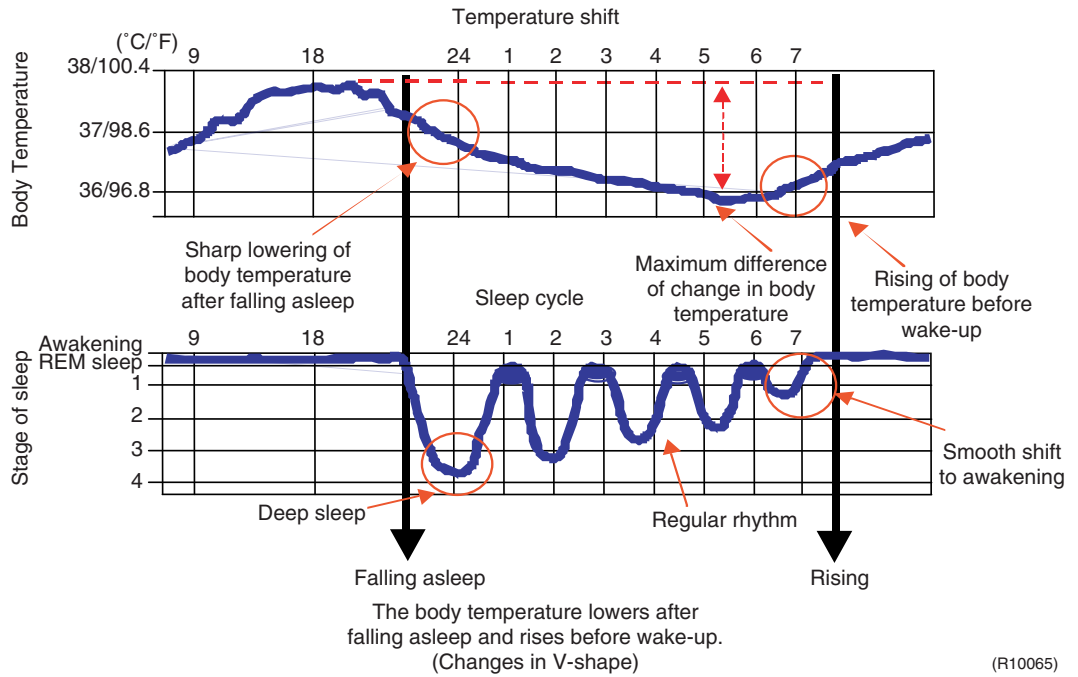

(R10065)

- Time chart of the V-shape comfort sleep control

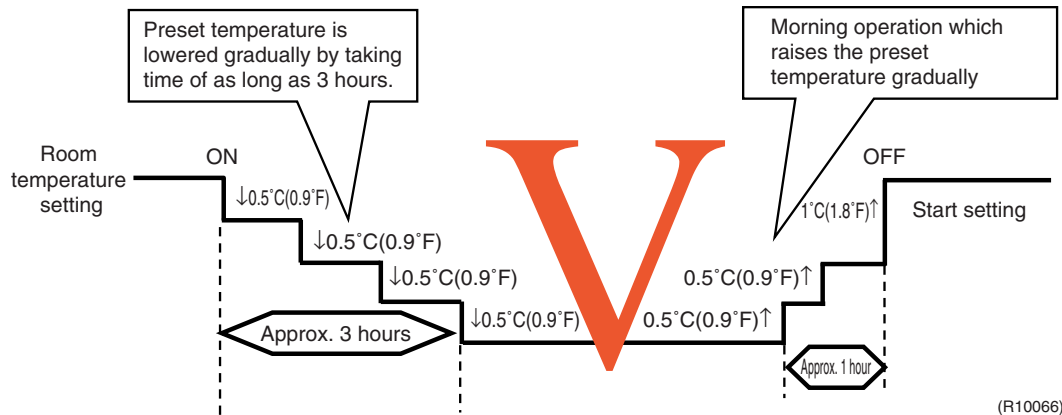

(R10066)

Reference

- Effect

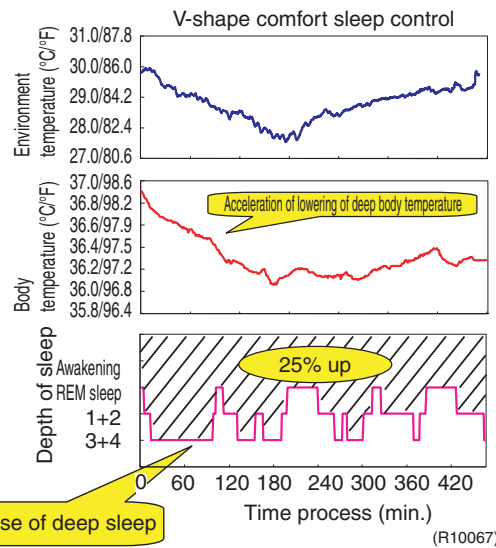
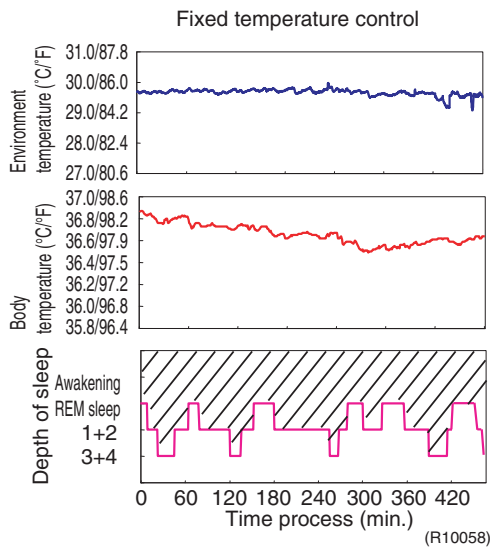

2.3 Automatic Operation

Operation

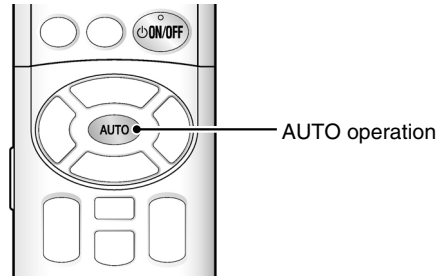

(R10068)

* Refer to the operation manual for details.

Features

When the AUTO mode is selected with the remote controller, the microcomputer automatically determines the operation mode from cooling and heating according to the room temperature and setting temperature at the time of the operation startup, and automatically operates in that mode. The unit automatically switches the operation mode to cooling or heating to maintain the room temperature at the main unit setting temperature.

Details

- Remote controller setting temperature is set as automatic cooling / heating setting temperature (18~30°C/64~86°F).
- Main unit setting temperature equals remote controller setting temperature plus correction value (correction value: 0 deg).
- Operation ON / OFF point and mode switching point are as follows.
 - Heating → Cooling switching point:
Room temperature \geq Main unit setting temperature +2.5°C(4.5°F).
 - Cooling → Heating switching point:
Room temperature $<$ Main unit setting temperature -2.5°C(4.5°F).
 - Thermostat ON / OFF point is the same as the ON / OFF point of cooling or heating operation.
- During initial operation
Room temperature \geq Remote controller setting temperature: Cooling operation
Room temperature $<$ Remote controller setting temperature: Heating operation

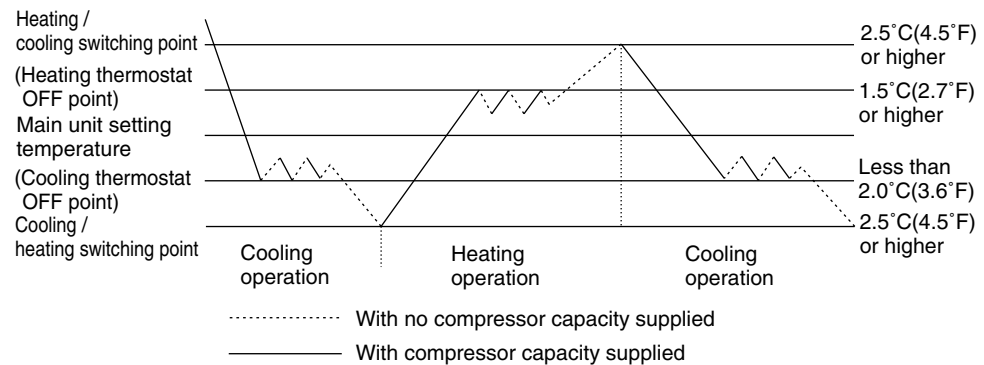

(R10069)

2.4 Comfort Airflow Mode

Operation

- Effective mode for comfort airflow mode

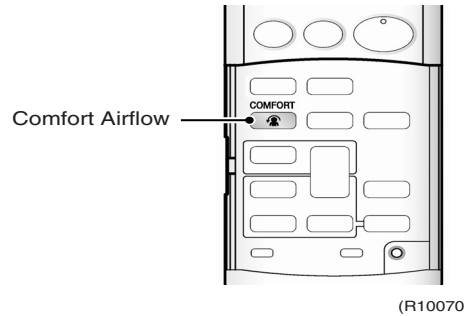

- Heating
 - Auto / Cooling
 - **QUATERNITY** drying
 - Dry cooling
 - Fin motion
 - Upper and lower fins halt at the fixed position of the upper side or lower side of the swing.
 - Left and right fins move according to the settings of remote controller.
 - Airflow rate
 - Airflow rate is at “automatic”.
- * Refer to the operation manual for details.

Features

- **Draftless operation prevents direct blowing of air on people**

Draftless operation deters direct blowing of air on skin. Cool air is blown up in the room and changed into a slow downward flow, circulating into entire room. Meanwhile the warm air is blown down vertically the occupants' feet, warming the room from the floor.

- Feel cold during cooling operation

- When comfort airflow mode is carried out in cooling, comfortable radiant cooling is realized.

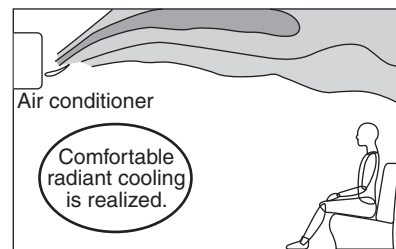
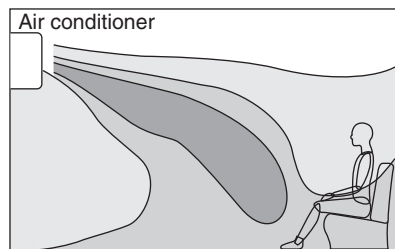

(R3355)

- Feel air during heating

- When comfort airflow mode is carried out in heating comfortable radiant heating is realized.

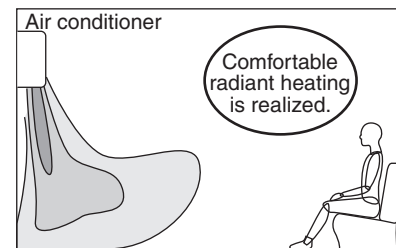
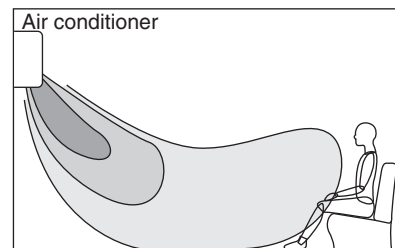

Note

In heating operation, it takes time to transmit heat to a distant place because the airflow direction is controlled not to blow directly on humans. It is recommended that this operation mode is used after the room has been warmed up.

2.5 Cooling Breeze Operation

Operation

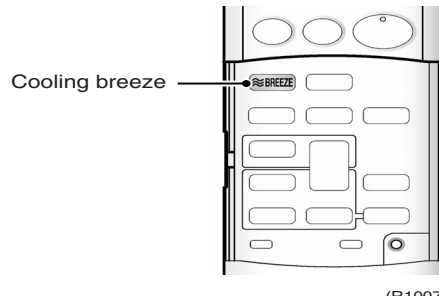

- Effective mode for cooling breeze airflow

- Auto / Cooling
- **QUATERNITY** drying
- Dry cooling
- Flash streamer air purifying



Note

In automatic mode, when actual operation mode is heating, this cool air fluctuation operation does not work. (Indication on remote controller is shown.)

- Fin operation

As shown in the following graph, the standard point is the upper limit of the swing so that the air does not touch directly.

Depending on the room temperature or the thermostat on/off state, the swing interval is changed.

The lower the temperature, the longer the swing interval, thereby comfort is maintained. Left and right fins move as set on the remote controller.

- Airflow rate

Airflow rate is controlled automatically.

* Refer to the operation manual for details.

Features

- **1/f fluctuation rhythms switches airflow direction**

By fluctuating airflow direction you can feel cool even if the room temperature is set high.

By 1/f fluctuation rhythm, upper and lower louvers move up and down unlike the conventional up and down swing, and this movement brings you comfortable air like breezes in nature.

Swing swaying (for example)

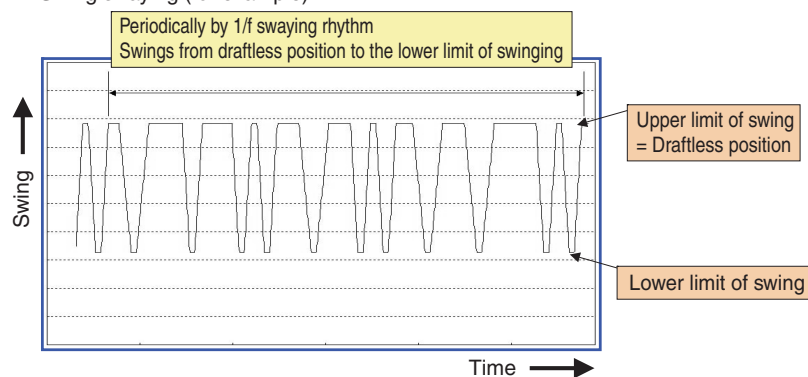

(R3357)

2.6 Power-airflow Dual Fins

- Triple airflow by the combination with wide-angle louvers

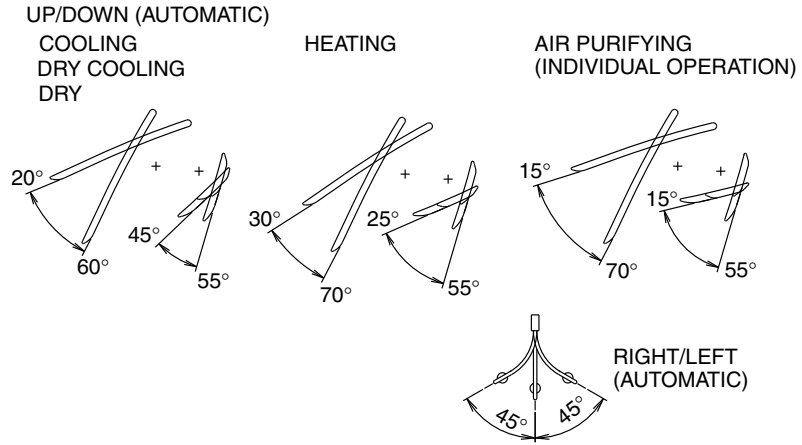

2.7 Wide-angle Fins

Wider airflow eliminates uncomfortable irregular temperature distribution. Wide-angle fins, enabling wider airflow to the left and right, are implemented to provide comfortable airflow to every corner of the room.

- Wide-angle Louvers

Direction of airflow changes greatly along the shape of curved vane.

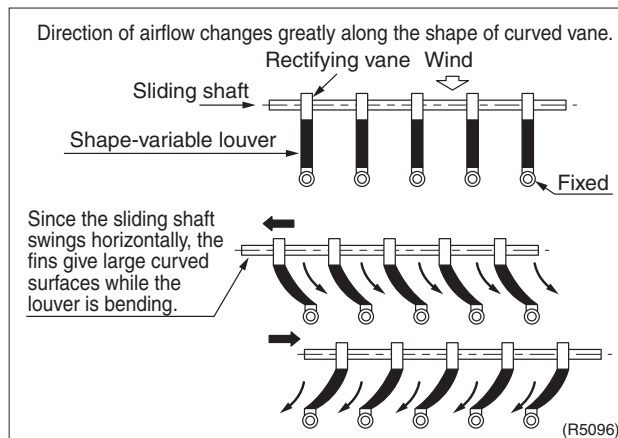

- Fin angle

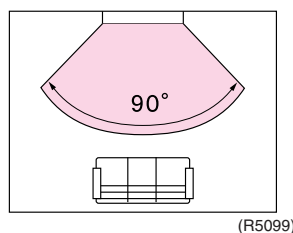

- It can send the airflow to the center of the room even when the airconditioner is installed in the corner of the room.

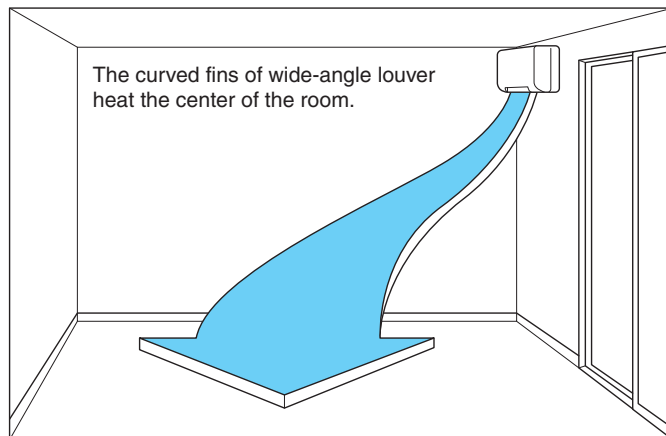

(R5098)

2.8 3-D Airflow

Alternating swing of blades in vertical and horizontal directions circulates the airflow to every corner of the room and prevents uneven temperature distribution.

Use of the 3-D airflow control prevents uneven temperature distribution in the whole room.

Particularly, the comfortable zone 10 cm (4 inch) above the floor is widened 1.5 times of the conventional zone.

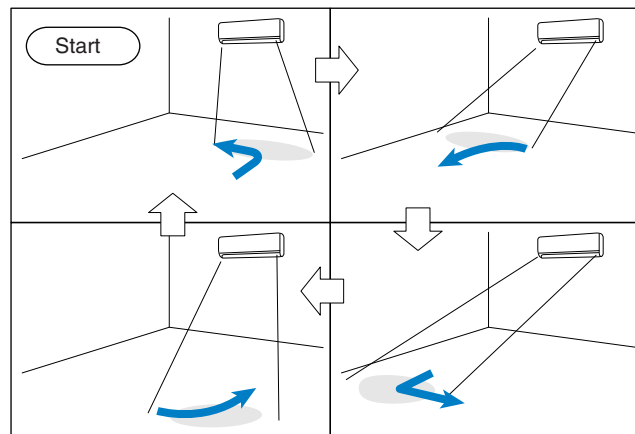

(R5102)

- If it is used at the start of operation, a sudden draft may cause you to feel chilly.
- Use it after the room temperature is stabilized.

2.9 POWERFUL Operation

Operation

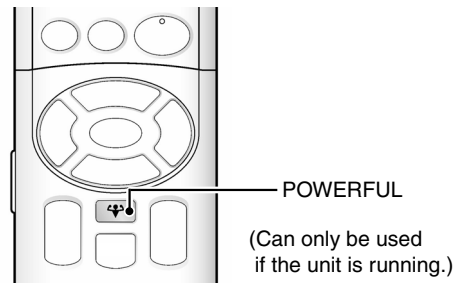

(R10073)

- Effective mode for POWERFUL COOLING
 - Cooling
 - Dry cooling
- Effective mode for POWERFUL HEATING
 - Heating

* Refer to the operation manual for details.



Note

- Operating sound becomes slightly louder.
- It is impossible to change the airflow rate, temperature, and humidity.

Features

The airflow rate and the compressor rotating speed are increased from the normal operation for 20 min. This operation is convenient when you return home. Normal operation will be resumed automatically in 20 minutes.

2.10 Indoor Unit Quiet Operation

Features

Forced lowering of the fan speed decreases the airflow rate and reduces airflow sound. Sound is reduced by about 3 dB as compared to that in L speed.



Note

- Airflow rate can not be set.
- Since the performance is somewhat lowered as compared to that in normal operation (70% under rated conditions), the room may not be cooled (or heated) when this operation is used for a long time.
- The indoor unit quiet operation is kept in memory even when the power supply is turned OFF. The indication remains on the display of the wireless remote controller and the indoor unit quiet operation works when the power is turned ON again.

2.11 Multi-colored Indicator Lamp

Features

Current operation mode is displayed in color of the lamp of the indoor unit. Operating status can be monitored even in automatic operation in accordance with the content of actual operation.

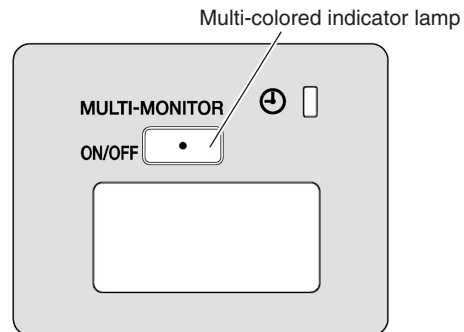

(R10074)

- The lamp color changes according to the operation.
 - HEATINGRed
 - COOLINGGreen
 - **QUATERNITY DRYING /**
DRY COOLING Yellow
- The lamp color also changes according to the optional function.
 - FLASH STREAMER AIR PURIFYING White
(Only for the first 2 seconds during operation of the air conditioner.)

2.12 Monitor Brightness Setting

The brightness of the multi-colored indicator lamp can be adjusted HIGH, LOW, or OFF.

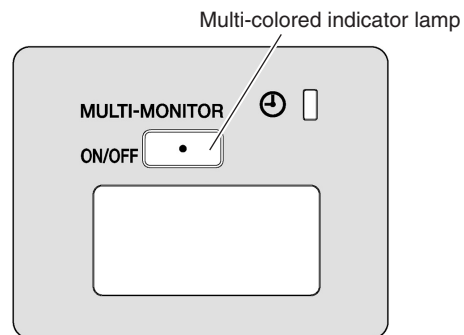

(R10075)

* Refer to the operation manual for details.

2.13 Information Display

Operation

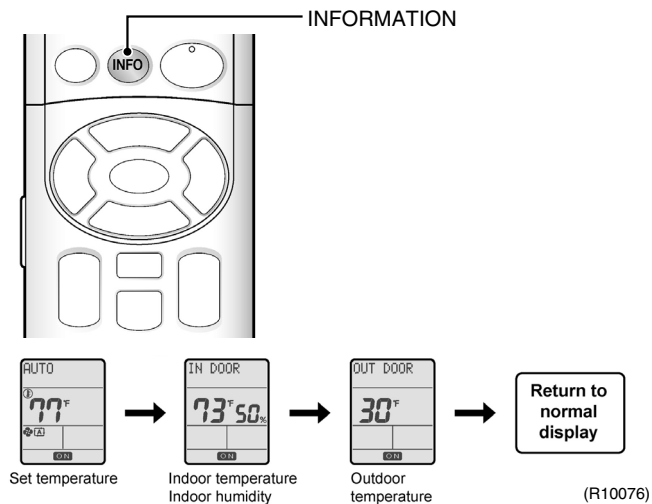

* Refer to the operation manual for details.

Features

- Room temperature, indoor humidity, and outdoor temperature are displayed.
- Point the remote controller at the indoor unit for 2 seconds.

i Note

- During operation, the outdoor temperature may sometimes be displayed higher than it actually is in COOLING or **QUATERNITY** DRYING mode or lower in HEATING mode (especially if frost has accumulated on the outdoor unit), due to the effects of the air blown from the outdoor unit or the temperature of the heat exchanger.
- The lowest indoor and outdoor temperature which can be displayed is -9°C (16°F). This will be displayed even if the actual temperature is lower. The highest temperature is 37°C (99°F). This will be displayed even if the actual temperature is higher.
- The indoor and outdoor temperatures and the humidity that are displayed are those near the sensors attached to the main air conditioner unit.
- The displayed temperature and humidity should only be taken as approximations, as they may be affected if there are objects around the sensors or due to direct sunlight depending on where the air conditioner is installed.

2.14 Mold-Proof Stick

Features

- Drain pan which prevents mold proliferation

The drain pan of the main unit can easily acquire mold so it is equipped with a mold-proof “Stick” providing a mildew-proof, antibacterial, and antivirus effect.

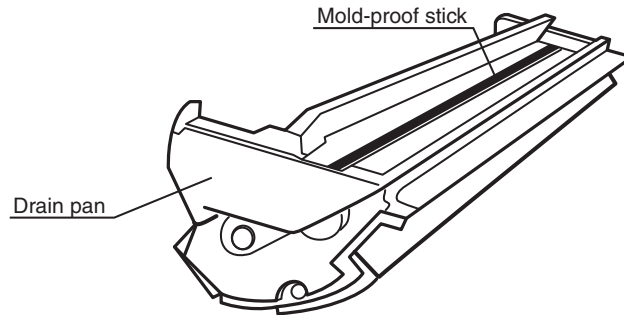

(R5104)

Since the mildew-proof, antibacterial and antivirus agent of the silver group (which is the compound of highly safe titanium oxide and silver) is used as a single agent, drain water is not affected by this agent.

The mildew-proof, antibacterial and antivirus agent is applied to a stick which is covered further with extremely thin resin skin of several microns (resin section without mildew-proof agent on the surface of the resin). The active ingredient is dissolved gradually for about 10 years by immersion and penetration of a mold-proof stick and drain water. Thus, the stick continues working.

- Image

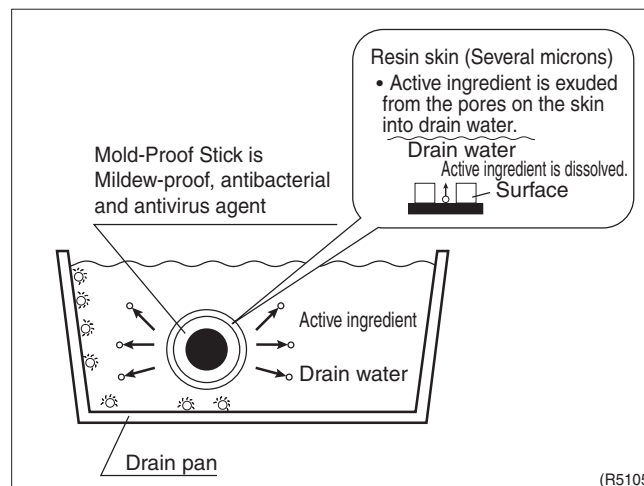

(R5105)

2.15 FLASH STREAMER AIR PURIFYING Operation

Operation

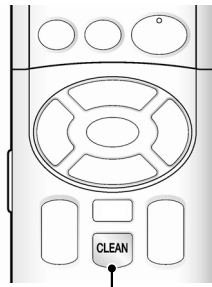

FLASH STREAMER AIR PURIFYING operation

(R10078)

* Refer to the operation manual for details.

■ FLASH STREAMER AIR PURIFYING

The technology for the real air purifier is adopted for the air conditioner. Our original **Flash Streamer** system technology used for our Daikin air purifiers is incorporated.

This technology far exceeds the air purifying performance of a normal air conditioner.

Daikin's advanced Flash Streamer Air-Purifying Unit effectively eliminates unpleasant odors, such as cooking or pet odor, cigarette smoke, and some allergens, viruses, and bacteria such as MS2 Virus and E. coli Bacteria.

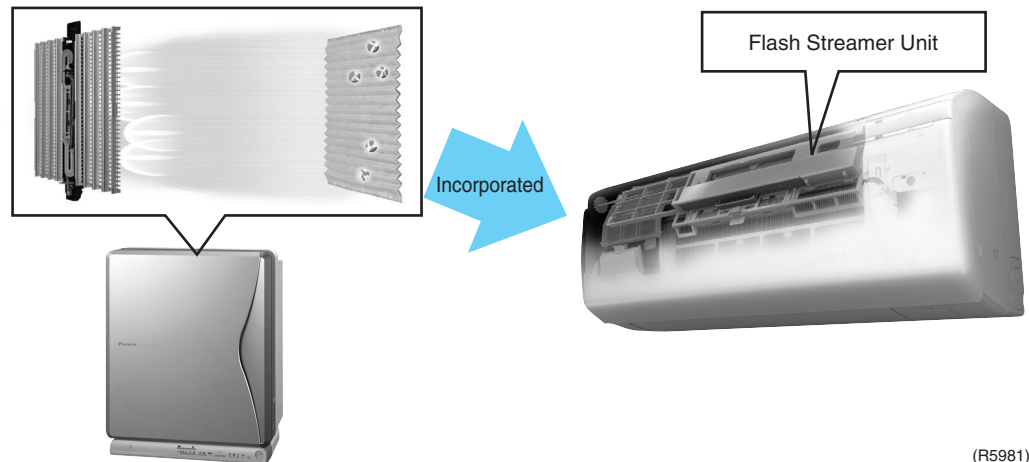

(R5981)

■ Mechanism of FLASH STREAMER AIR PURIFYING+

The streamer discharges high energy electrons, analyzes and removes powerful odors, some allergens, viruses, and bacteria such as the MS2 Virus and E. coli Bacteria at the oxidative distraction speed of 1000 times higher than the usual glow discharge.

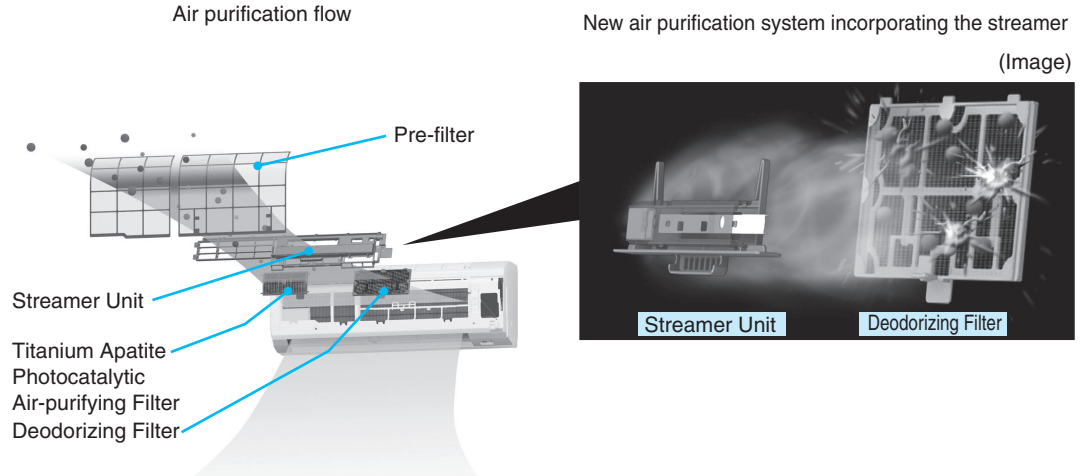

Powerfully decomposes and removes molecules of allergens or odors by collision with high-speed electrons discharged from streamer unit.

(R5982)

■ Removing Formaldehyde

Analyzes and quickly removes building material odors.

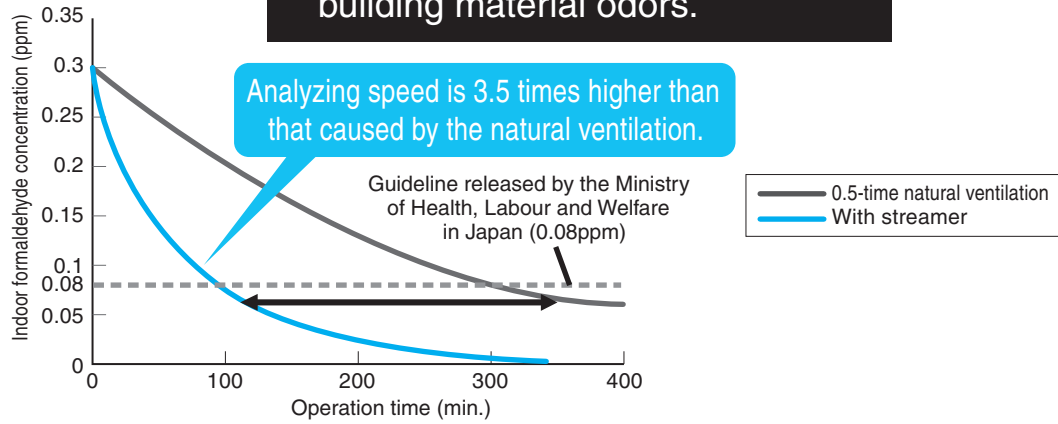

The formaldehyde concentration in the laboratory (10 m²/108 sq feet) at 0.5-time ventilation and the initial concentration setting of 0.3 ppm (Observed by Daikin) (Nozaki laboratory, Graduate Course of Health and Society System, Tohoku Bunka Gakuen University)

(R10079)

■ **Deodorizing Performance of Flash Streamer and Titanium Apatite Photocatalyst**

Unpleasant odor generating daily in the room such as pet odor or garbage odor is efficiently removed. Speedy deodorization: 90% or more odor has been removed in 10 minutes. Cigarette odor of 80% or more has been removed.

Daily odor removal performance by streamer air purifying (%)

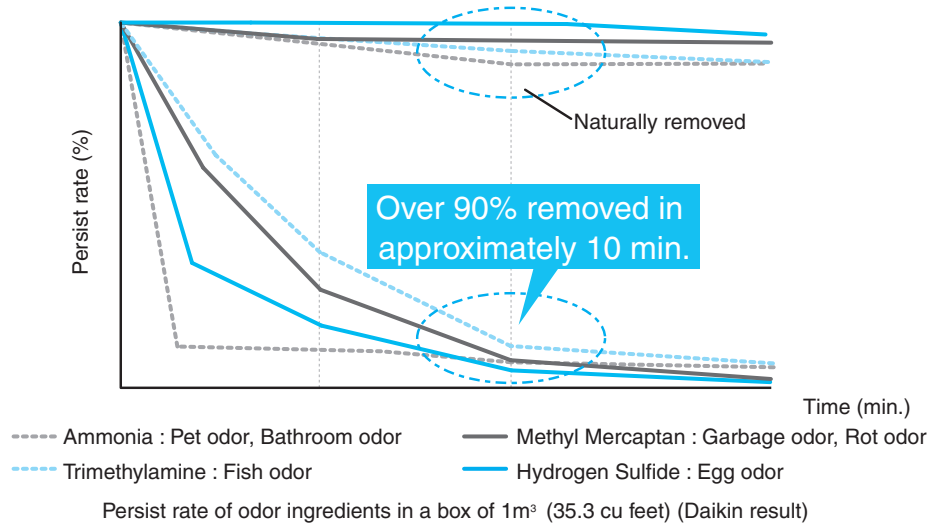

(R10080)

	Ammonia	Acetaldehyde	Acetic Acid	Cigarette Odor
Removal	90.6%	76.5%	87.2%	82.7%

2.16 Wipe-clean Flat Panel

Dirt can be wiped off the panel instantly. There is no grille and the panel can be easily removed for washing.

Remove the panel in the procedure as mentioned below, wipe it lightly with soft cloth soaked with lukewarm water or cold neutral detergent solution and dry it in the shade.

Note: If it is washed with use of polishing powder or scrubber, or in the water hotter than 40°C (104°F), it may be scratched, discolored or deformed.

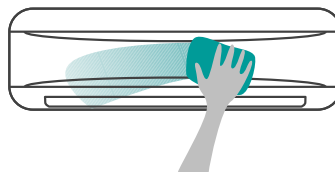

(R5115)

■ **Caution**

- When mounting or dismounting the front panel, use a robust and stable stand and watch your step.
- Proceed to work while supporting the front panel securely by hand.
- Do not use water hotter than 104°F (40°C), or benzine, gasoline, thinner, or other volatiles, polishing powders, or scrubbers.
- Make sure that the front panel is mounted securely.

2.17 Filter Cleaning Indicator (Remote Controller)

After the unit operates for about 2 weeks (about 340 hours), the filter cleaning indicator alerts you that it is time for maintenance.

If the filter is left dirty, the power consumption increases by about 10%. It is recommended to maintain it periodically to ensure energy-saving operation.

- How to reset the filter cleaning indicator

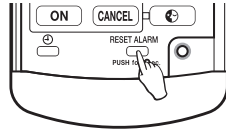

When the **RESET ALARM** button on the remote controller is pressed for about 2 seconds pointed toward the indoor unit after maintenance of the filter, the filter-cleaning indicator disappears.

(R5118)

2.18 TIMER Operation

2.18.1 24-hour ON/OFF Timer

Operation

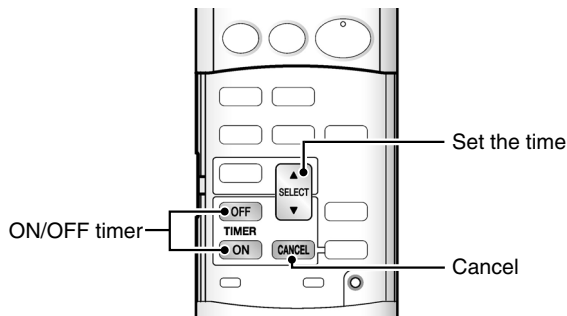

(R10081)

* Refer to the operation manual for details.

Features

- Time can be set in 10 minute increments.
- When the 24-hour ON/OFF is set, the indication of present time disappears.
- Time is kept in memory in the next operation unless it is cancelled.
- The clock error is ± 30 seconds per month.

ON Timer

The microcomputer monitors the indoor temperature and outdoor temperature before preset time and the operation is started automatically 1 hour before at maximum so that the room temperature becomes optimum at the preset time.

2.18.2 COUNTDOWN OFF Timer

Operation

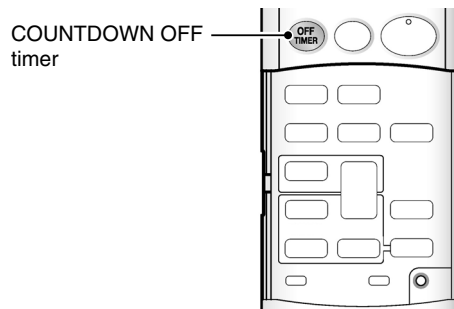

(R10082)

* Refer to the operation manual for details.

Features

- The COUNTDOWN OFF timer sets the time by simple button pressing. The operation is stopped when the set time comes. The time can be set in the unit of 0.5 hour for maximum 9.5 hours. It can be used in combination with the ON timer.

2.18.3 Combination of ON Timer and OFF Timer

- ON timer and OFF timer, or ON timer and COUNTDOWN OFF timer can be used in combination.

Refer to the operation manual for details.

2.19 Night Set Mode

- When you set the COUNTDOWN OFF TIMER or OFF TIMER, the unit is operated automatically in night set mode.

Cooling / Dry cooling

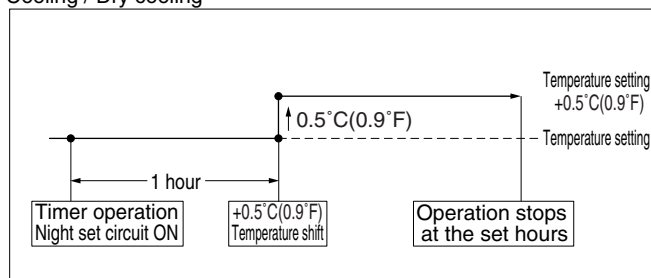

(R10083)

Heating

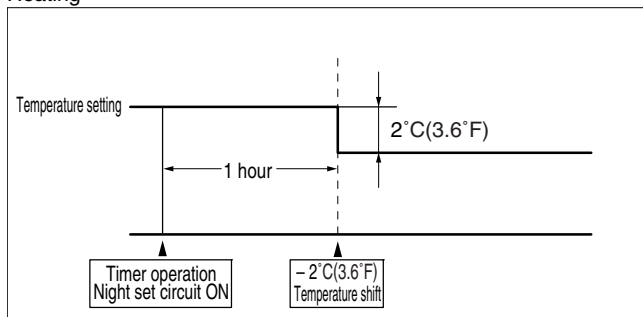

(R10084)

2.20 Table for Special Modes

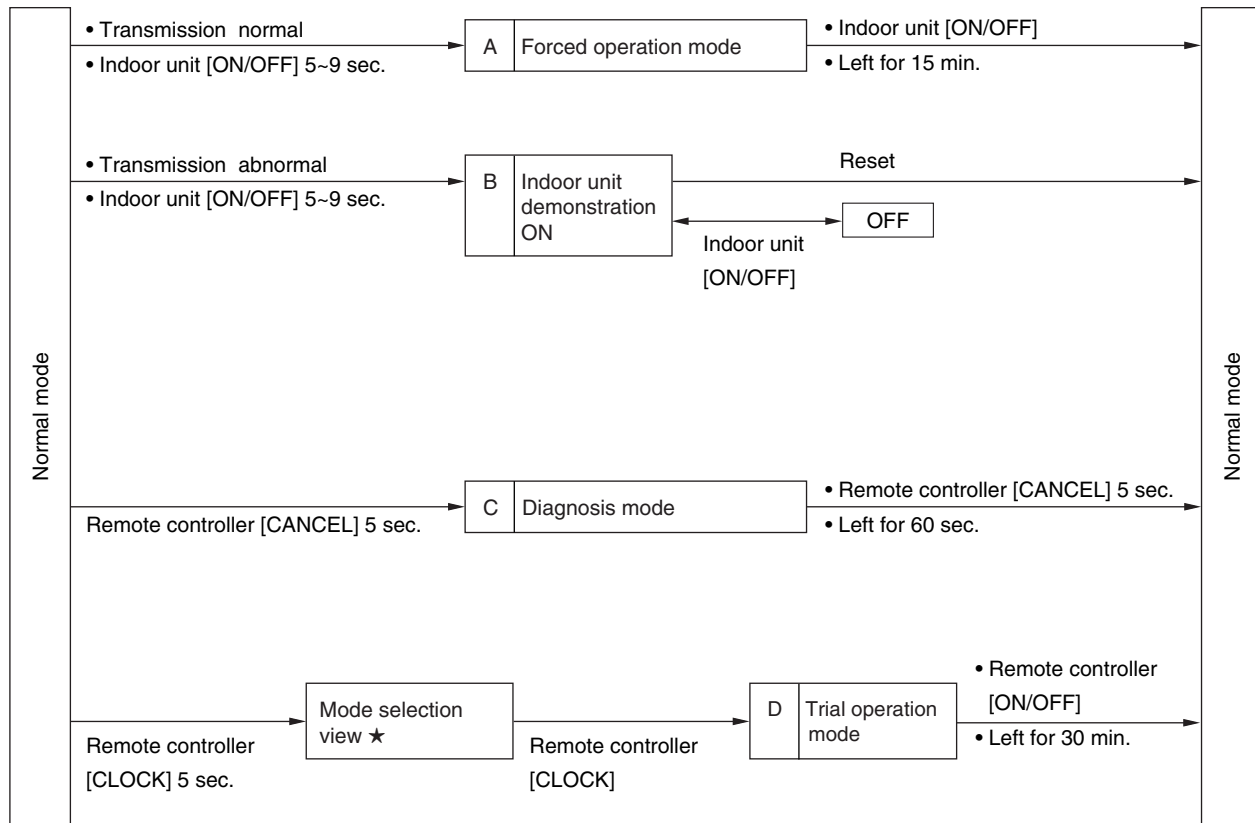

★ : For FTXG 09/12/15 models,
you cannot select any other mode but trial operation mode.

(R10193)

A. Forced operation mode:

Forced operation mode will be set by pressing the ON/OFF button for between 5 to 9 seconds while the unit is not operating.

The buzzer beeps, and the timer and multi-colored indicator lamp illuminate. The operation ends automatically after 15 minutes.

B. Indoor unit demonstration:

You can see the demonstration of the multi-colored indicator lamp, open / close movement of the front panel, and swing of the flaps.

C. Diagnosis mode:

Diagnosis mode is improved to enable one-touch indication by applying two-way communication. Refer to page 85 for details.

D. Trial operation mode:

- ◆ You can select a mode for trial operation on the remote controller.
- ◆ The operation continues for approx. 30 minutes.
- ◆ The delay time to start compressor can be set by “▲ (forward)” button by 0 min., 1 min. or 3 minutes.

Refer to the installation manual on page 63 for details.

2.21 Thermostat Control

Outline

When COOLING or HEATING mode is selected with the remote controller, the microcomputer prevents the unit from turning OFF until the requested room temperature is achieved. **Details**

In the table below you can find the thermostat ON and OFF conditions for a set point of 70°F(21°C).

		OFF	ON	Monitoring	
Cooling	Set point 70°F(21°C) --> shift 0.5°C (0.9°F)	67.1°F(19.5°C)	69.8°F(21°C)	68.0~68.9°F (20~20.5°C)	10min
Heating	Set point 70°F(21°C) --> shift 2.0°C (3.6°F)	76.1°F(24.5°C)	73.4°F(23°C)	74.3~75.2°F (23.5~24°C)	10sec

Cooling operation:

The unit will turn OFF by thermostat when the room temperature reaches 19.5°C(67.1°F). When the room temperature rises above 21°C(70°F), the thermostat turns back ON and the unit resumes its operation. When the room temperature is between 20~20.5°C(68.0~68.9°F), it is in the monitoring zone. If for cooling, the room temperature stays in the monitoring zone for more than 10 minutes, the thermostat will also turn back ON and the unit will resumes its operation.

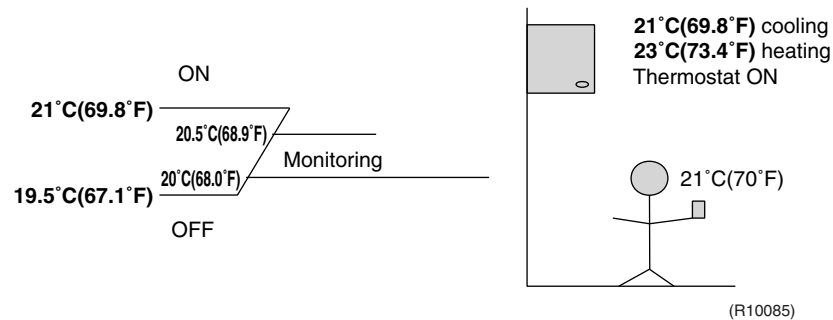

Between the indoor unit and the position of the end user, there is taken into calculation a temperature shift of 0.5°C(0.9°F in the control logic). This means that at thermostat OFF, the temperature at the end user is e.g. 20°C(68.0°F).

Heating operation:

The unit will turn ON by thermostat when the room temperature reaches its set value + a shift of 2.0°C (3.6°F) (e.g. room temperature : 21°C (70°F) => thermostat ON temperature : 23°C (73.4°F)). When the room temperature rises above 24.5°C (76.1°F), the thermostat turns back OFF. When the room temperature is between 24~23.5°C (75.2~74.3°F), it is in the monitoring zone. If for heating, the room temperature stays in the monitoring zone for more than 10 minutes, the thermostat will also turn back ON and the unit will resume operation.

2.22 Fan Speed Control for Indoor Units

Control mode The airflow can be automatically controlled depending on the difference between the set temperature and the room temperature. This is done through speed control and Hall IC control.

Phase steps Speed control and fan speed control contains different steps:

Step	Cooling	Heating	Dry mode
LLL	 (R4085)	 (R4085)	09 · 12 · 15 class : 1000 rpm No POWERFUL
LL			
SL (Quiet)			
L			
ML			
M			
MH			
H			
HH (POWERFUL)			

= Within this range the airflow rate is automatically controlled when the FAN setting button is set to automatic.

1. During POWERFUL operation, fan rotates at H tap + 80 rpm.
2. Fan stops during defrost operation.
3. In time of thermostat OFF, the fan rotates at the following speed.
 Cooling: The fan keeps rotating at the set tap.
 Heating: The fan stops.

09 class	LLL	LL	SL	L	ML	M	MH	H	HH
Cooling	---	590	720	790	900	1020	1140	1260	1340
Heating	350	590	790	860	970	1080	1190	1300	1380

12 class	LLL	LL	SL	L	ML	M	MH	H	HH
Cooling	---	590	750	820	950	1080	1210	1350	1430
Heating	350	590	820	890	1010	1130	1250	1380	1460

15 class	LLL	LL	SL	L	ML	M	MH	H	HH
Cooling	---	590	790	860	1000	1140	1280	1420	1500
Heating	350	590	860	950	1070	1190	1310	1440	1520

In the above table you can see all the different fan speeds of the indoor units fan motor.

When selecting AUTOMATIC airflow control on the remote controller, the indoor fan speed will be regulated according to the difference between the room temperature and the required set point in cooling mode. On heating mode, the indoor fan speed will be regulated according to the indoor heat exchanger temperature and the difference between the room temperature and the required set point.

Cooling

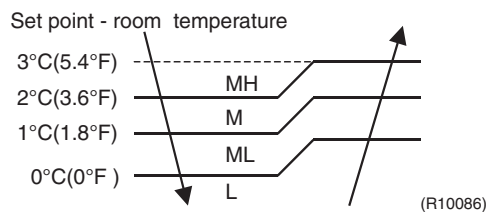

Heating

Room temp.area	Indoor heat exchanger temperature area						
	G	F	E	D	C	B	A
A	MH	ML	ML	L	L	L	LL
B	MH	ML	ML	L	L	L	LL
C	MH	ML	ML	L	L	L	LL
D	MH	M	ML	ML	L	L	LL
E	MH	M	M	ML	ML	L	LL
F	MH	MH	M	M	ML	L	LL
G	MH	MH	MH	M	ML	L	LL
H	MH	MH	MH	MH	M	M	M
I	MH	MH	MH	MH	M	M	M
J	MH	MH	MH	MH	MH	MH	MH
K	MH	MH	MH	MH	MH	MH	MH
L	MH	MH	MH	MH	MH	MH	MH

Room temperature area

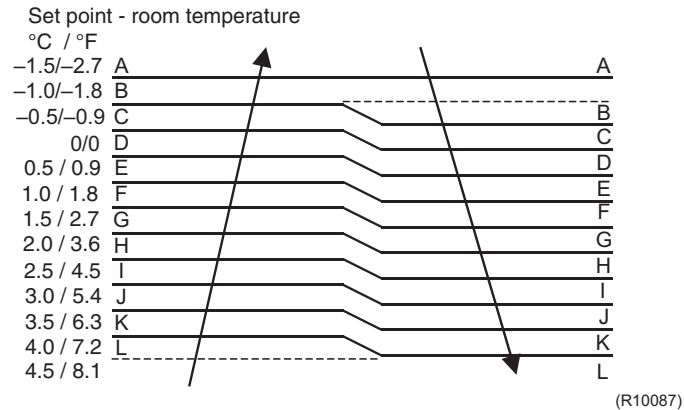

The value will increase when the operation starts.

Indoor heat exchanger temperature area

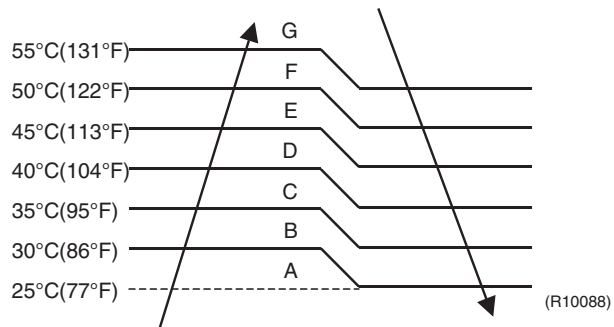

2.23 Draft Prevention (Hot-Start)

Outline

Draft prevention control is carried out to prevent a cold draft feeling when the unit is started in heating operation. This also will happen if the indoor heat exchanger temperature drops.

Details

The outdoor unit will prevent a cold draft by monitoring the indoor heat-exchanger thermistor. It will increase the minimum compressor frequency if the indoor heat exchanger drops below 33°C (91.4°F). If the indoor heat exchanger is not hot enough, the indoor fan will not start at the set speed.

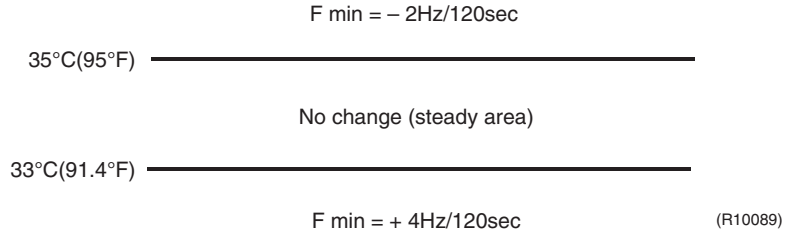

The fan speed will be reduced step by step. The limitation of the fan speed will be lifted when the indoor heat exchanger temperature rises above F°C.

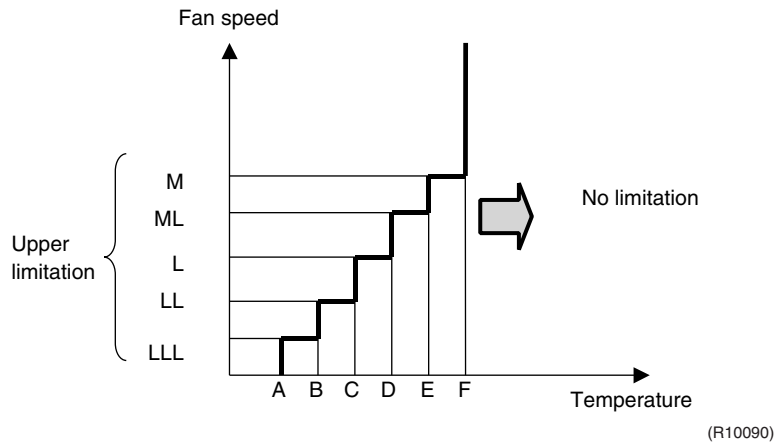

(Unit : °C/°F)

	A	B	C	D	E	F
09 class	10/50	25/77	33/91.4	34/93.2	35/95	36/96.8
12 class	10/50	25/77	35/95	37/98.6	38/100.4	39/102.2
15 class	10/50	25/77	35/95	37/98.6	38/100.4	39/102.2

3. Control Specification

3.1 Frequency Control

Outline

Once the timers for the compressor start-up have elapsed, the unit will determine its compressor frequency from the following parameters;

ΔD : The difference between the room temperature and the setpoint ($^{\circ}\text{C}$)

Indoor frequency command

The indoor command frequency is determined by the difference between the room temperature and the temperature set by the remote controller. Out of this difference a ΔD value (D from difference) is calculated which is then send to the outdoor unit.

Underneath you'll find a table, which relates the different ΔD values to the temperature differences.

Temperature difference $^{\circ}\text{C}(^{\circ}\text{F})$	ΔD signal	Temperature difference $^{\circ}\text{C}(^{\circ}\text{F})$	ΔD signal	Temperature difference $^{\circ}\text{C}(^{\circ}\text{F})$	ΔD signal	Temperature difference $^{\circ}\text{C}(^{\circ}\text{F})$	ΔD signal
0 (0)	*Th OFF	2.0 (3.6)	4	4.0 (7.2)	8	6.0 (10.8)	C
0.5 (0.9)	1	2.5 (4.5)	5	4.5 (8.1)	9	6.5 (11.7)	D
1.0 (1.8)	2	3.0 (5.4)	6	5.0 (9.0)	A	7.0 (12.6)	E
1.5 (2.7)	3	3.5 (6.3)	7	5.5 (9.9)	B	7.5 (13.5)	F

*Th OFF = Thermostat OFF

Table: ΔD value summary table

Initial frequency setting

When starting the compressor, the frequency must be (re-) initialized in accordance to the ΔD value. Out of this parameters, the micro-controller will determine the initial compressor frequency. The frequency changes because of the decreasing ΔD value of the indoor unit. The frequency also changes through limiting functions, which are protecting the unit. Some of these directly control the operating frequency.

Other functions will change the upper or lower frequency limit, preventing the unit from going into a certain operation frequency that will damage it.

PI Control

The PI control will ensure a fast and efficient way of determining the compressor frequency build up.

Details

I control

This regulator will look at the temperature difference between the room temperature and the set point (ΔD).

- $\Delta D > 4$ then the compressor frequency will rise with ΔD Hz per 120 sec.
- $\Delta D = 4$ then there is no change.
- $\Delta D < 4$ then the compressor frequency will drop with 4 Hz per 120 sec.

P control

This regulator will look at the differences between the room temperatures and the setpoints (ΔD) in time.

Compare the current ΔD and the last ΔD (20 seconds before). If any change is observed, correct the value calculated by the following formula.

- $(\Delta D_{\text{currently}} - \Delta D_{\text{last measurement}}) \times 4$

3.2 Preheating Operation (Quick Warming Function)

Outline Operate the inverter in the open phase operation with the conditions including the preheating command from the discharge pipe temperature.

Details **ON condition**
 The preheating operation starts when the discharge pipe temperature drops. At that time, the inverter in open phase operation starts. This means that a small current is send through one of the compressor windings in order to heat up the inside of the compressor. This is done in order to prevent liquid compression at start-up of the compressor when the outdoor temperature is low.

OFF condition
 When the discharge temperature is higher than a certain value, the inverter in open phase operation stops.

The inverter in open phase control consumes approximately 25~40W.

Note When the preheating operation is active, there is the possibility that a frequency noise can be noticed at the outdoor unit site due to the open phase control.

outdoor temperature $\geq 7^{\circ}\text{C}$ (44.6°F)

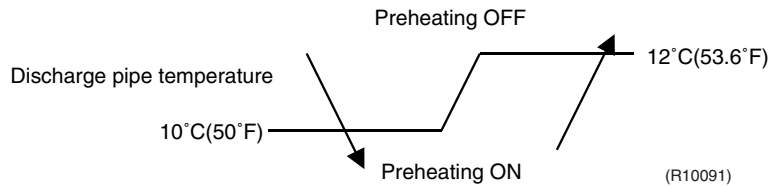

outdoor temperature $< 7^{\circ}\text{C}$ (44.6°F)

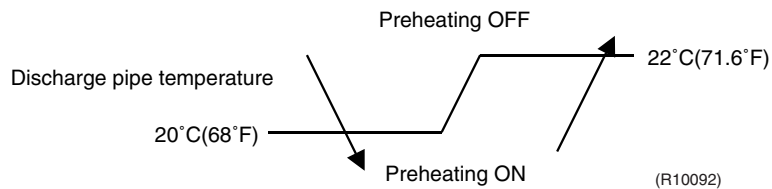

3.3 Four Way Valve Operation

Outline Because the four-way valve only operates properly when there is an adequate pressure difference, the four-way valve compensation function has been implemented to insure this minimal pressure difference.

Details The four-way valve compensation function ensures the four-way valve operation by demanding a certain minimal operation frequency for a certain time. By doing this, the unit ensures the switching of the four-way valve.
 When this function is enabled, the unit will not look at the other safeties (with the exception of input current control).

The four-way valve compensation function is engaged in four cases

- When starting the compressor for heating.
- When the operation mode is changed.
- When starting the compressor for defrosting.
- When starting the compressor after a power failure (auto-restart).

No power to the valve --> cooling.

Power to the valve --> heating.

		Frequency [Hz]	Time [sec]
Cooling		52	60
Heating	outdoor temperature < 16°C(60.8°F)	52	
	outdoor temperature ≥ 16°C(60.8°F)	- 0.9 x outdoor temperature (°C) + 68	

3.4 Compressor Start-up Protection

Details

The gradual buildup of the upper operation frequency is illustrated in the graph below.

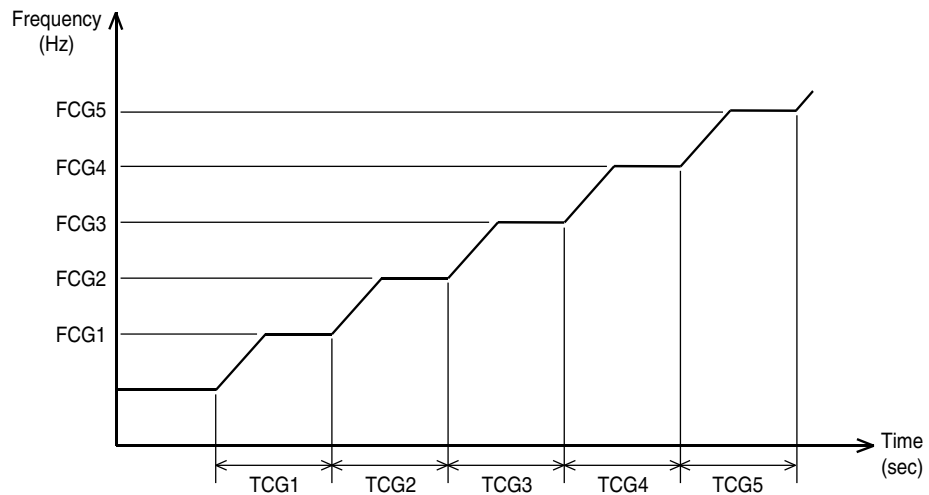

(R10093)

Fig. : Compressor protection function graph.

Timers and frequencies for the compressor protection function

FCG1	52
FCG2	52
FCG3	58
FCG4	80
FCG5	98
TCG1	450
TCG2	90
TCG3	90
TCG4	60
TCG5	60

3.5 Fan Speed Control for Outdoor Unit

Outline The fan speed control regulates the speed of the outdoor fan.

Details Fan control is carried out according to the following conditions.

1. Fan ON control for electric component cooling fan
2. Fan control when defrosting
3. Fan OFF delay when stopped
4. ON/OFF control when cooling operation
5. Fan control during heating operation

Cooling

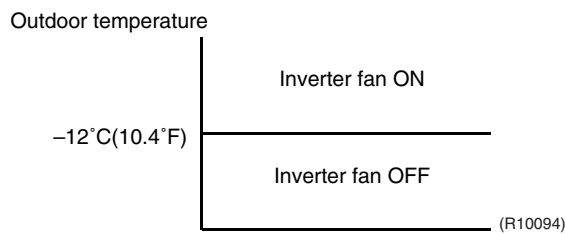

Class	Cooling
09	800rpm
12	850rpm
15	850rpm

The fan speed is fixed.

Heating

Class	Heating
09	750rpm
12	760rpm
15	810rpm

The fan speed is fixed.

3.6 Fin Thermistor Control

Outline

When the fin temperature rises, the fan rotation speed will increase to protect the electrical parts. This function is only applicable for inverters. The temperature sensor is located on the top of the radiation fins connected to the power elements of the electronic inverter circuit (PAM & PWM).

Details

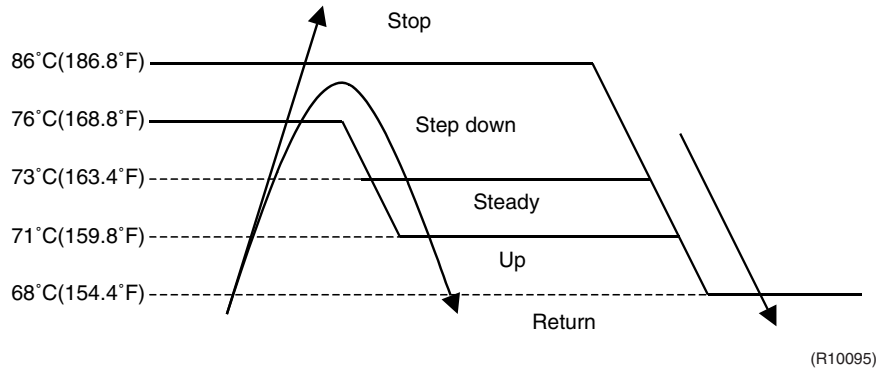

Return area:

- Limiting control for the minimum rotation speed of fan is cancelled.

Up area:

- The minimum rotation speed of fan decreases by 10 rpm / 60 seconds.

Steady area:

- The minimum rotation speed of fan remains constant.

Step down area:

- The minimum rotation speed of fan increases by 60 rpm / 30 seconds.

Stop area:

- The compressor will stop.

3.7 Input Current Control

Details

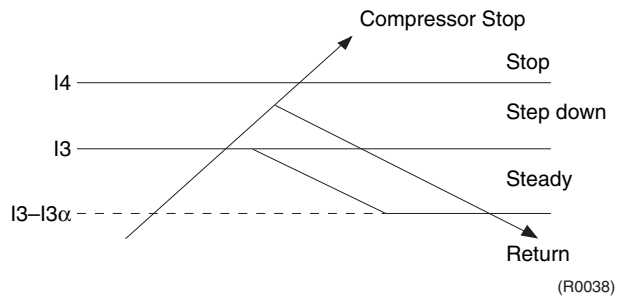

Class	Cooling			Heating		
	09	12	15	09	12	15
I4 (A)	14	14	14	14	14	14
I3 (A)	5.5	7.5	9.75	10.5	10.5	10.5

I3-I3α	4.5	6.5	8.75	9.5	9.5	9.5
--------	-----	-----	------	-----	-----	-----

Return area:

- Limiting control for the maximum frequency is cancelled.

Steady area:

- The maximum frequency remains constant.

Step down area:

- The maximum frequency in this control is defined as (operation frequency – 2 Hz).
- After this, the frequency decreases by 2 Hz / 1 second until it reaches the steady area.

Stop area:

- When this state continues for 5 seconds, the compressor will stop.

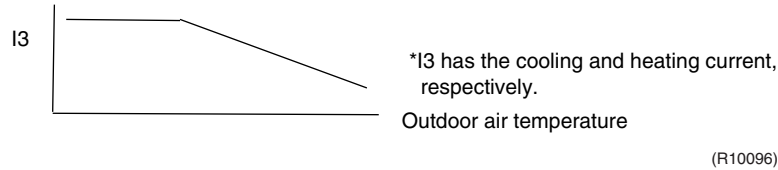

3.8 Peak-cut Control

Outline

In heating operation, malfunctioning of the unit (for example dirty filters) can cause the discharge pressure to rise excessively and reach unacceptable levels. To avoid this, peak-cut control will monitor the condensing temperature and when necessary decrease the operating frequency in an attempt to lower the discharge pressure at an early stage.

Details

In a similar way as with the freeze protection function, the peak-cut control function regulates the maximum operation frequency as indicated in the picture underneath.

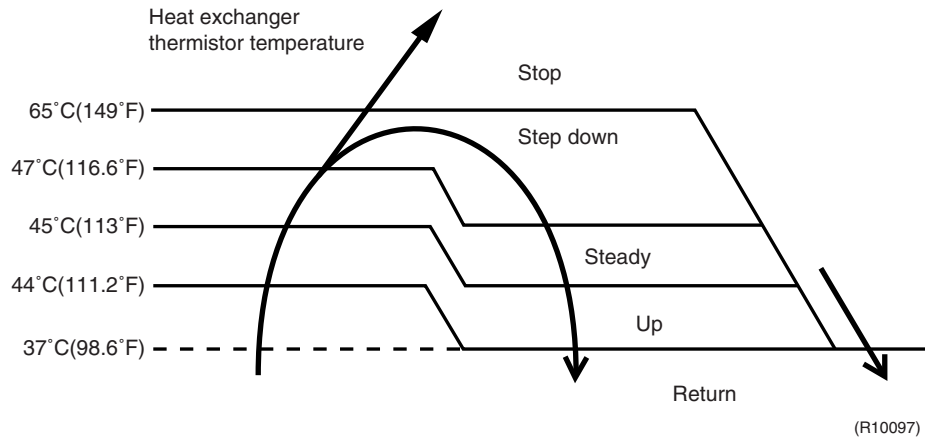

Fig. : Peak-cut control function graph

Return area:

- Limiting control for the maximum frequency is cancelled.

Up area:

- The maximum frequency increases by 2Hz / 3 minutes.

Steady area:

- The maximum frequency remains constant.

Step down area:

- The maximum frequency decreases by 4Hz / 20 seconds.

Stop area:

- The compressor, indoor fan, and outdoor fan will stop.

3.9 Indoor Heat Exchanger Freeze-up Protection

Outline

During cooling or dry operation, a malfunction of the unit may cause the indoor heat exchanger's temperature to drop excessively. To prevent the indoor heat exchanger from freezing up, the freeze protection function will reduce the compressor's maximum operation frequency.

Details

The freeze protection function regulates the maximum operation frequency as indicated in the following graph:

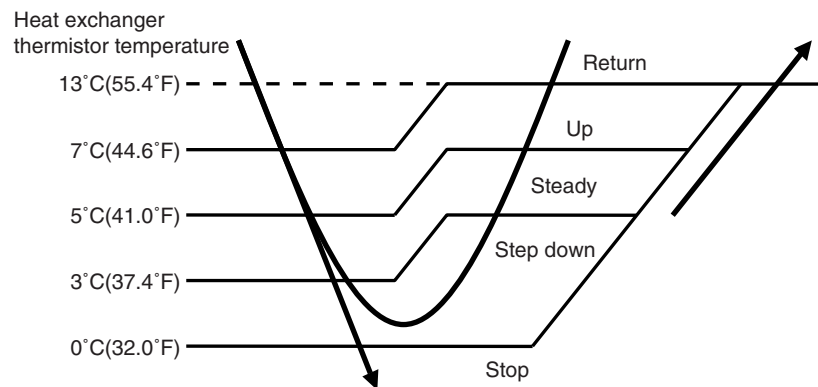

(R10098)

Return area:

- Limiting control for the maximum frequency is cancelled.

Up area:

- The maximum frequency increases by 2Hz / 90 seconds.

Steady area:

- The maximum frequency remains constant.

Step down area:

- The maximum frequency decreases by 2Hz / 60 seconds.

Stop area:

- The compressor stops completely and the outdoor unit fan will stop. The indoor unit fan operates at LL tap. The system will stay OFF until the indoor heat exchanger temperature goes to the return area.

3.10 Dew Prevention

Outline

Cooling the air around us means that the air is dehumidified (condensation of water on the coil). But because the air is cooled down, less water can be absorbed by the air and as a consequence the relative humidity of the air rises. When the relative humidity of the outlet air nears 100%, you will have water being blown in. To prevent this from happening, the unit will, under certain circumstances, change its target evaporating temperature and the frequency of the compressor. Normally speaking, even under these conditions (dew-prevention safety active), the room should still be cooled down, only slower. Of course, if the indoor unit is on the small size in comparison to the heat load, this will not be the case and capacity shortage complaints will follow.

Details

1. Conditions for initiating the dew prevention function.

- ① Operation mode is in cooling/dry.
- ② Compressor is running.
- The target temperature of heat exchanger (Δ °C) is calculated by the following formula with using the room temperature and indoor humidity.

$$\Delta = 15/16 \times \text{room temperature} + (\text{indoor humidity} + 5) \times 70/256 + \text{B}$$

Mode	Swing	Flap	B (°C)
Dry	—	—	-34
Cooling	ON	—	-34
	OFF	Downward	-34
		Upward	-32

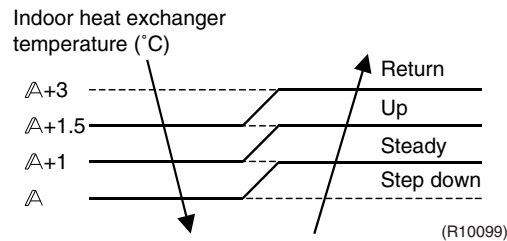

Return area:

- Limiting control for the maximum frequency is cancelled.

Up area:

- The maximum frequency increases by 2Hz / 90 seconds.

Steady area:

- The maximum frequency remains constant.

Step down area:

- The maximum frequency decreases by 2Hz / 60 seconds.

2. Conditions for ending the dew prevention function

- ① Operation mode is not in cooling/dry.
- ② Compressor is not running.

3.11 Liquid Compression Protection 2

Outline

The function will ensure a pressure differential between the high pressure and the low pressure. This is required when cooling with low outdoor air temperature because HP gets weak and you will have small capacity and a high power input. The compressor stops according to the conditions of the outdoor air temperature.

Details

Conditions

- ◆ Cooling or Dry cooling mode
- ◆ Not in forced cooling mode
- ◆ Outdoor air temperature < -12°C (10.4°F)

If all of these are fulfilled, the compressor is stopped. The system resumes operation when the outdoor air temperature rises above -12°C (10.4°F).

3.12 Discharge Pipe Temperature Control

Outline

Overheating has a negative influence on the operating lifetime of a compressor which is why this function will limit the maximum operating frequency of the compressor if deemed necessary.

Details

Discharge pipe temperature °C (°F)

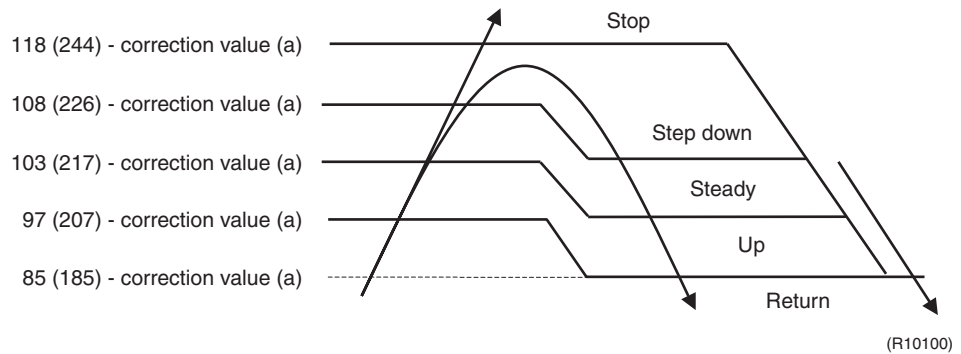

Correction value (a) = correction value by operation frequency (b) + correction value by outdoor temperature (c)

Correction value by operation frequency (b)

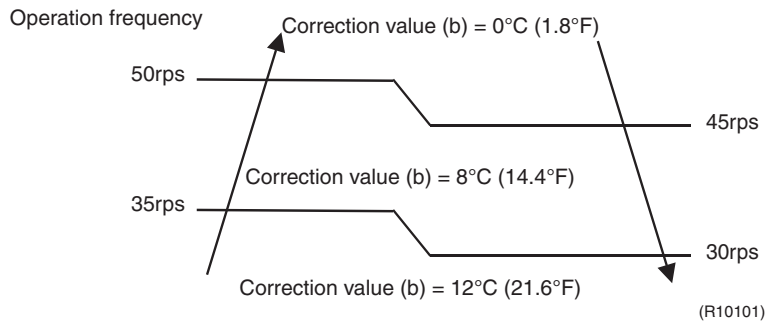

Correction value by outdoor temperature (c)

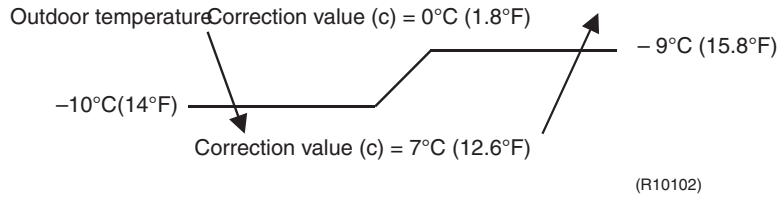

Return area:

- Limiting control for the maximum frequency is cancelled.

Up area:

- The maximum frequency increases by 2Hz / 60 seconds.

Steady area:

- The maximum frequency remains constant.

Step down area:

- The maximum frequency decreases by 4Hz / 30 seconds.

Stop area:

- The compressor stops and will only restart when the sensor senses a temperature below set point.

3.13 Automatic Defrosting

Defrost Control Start Condition

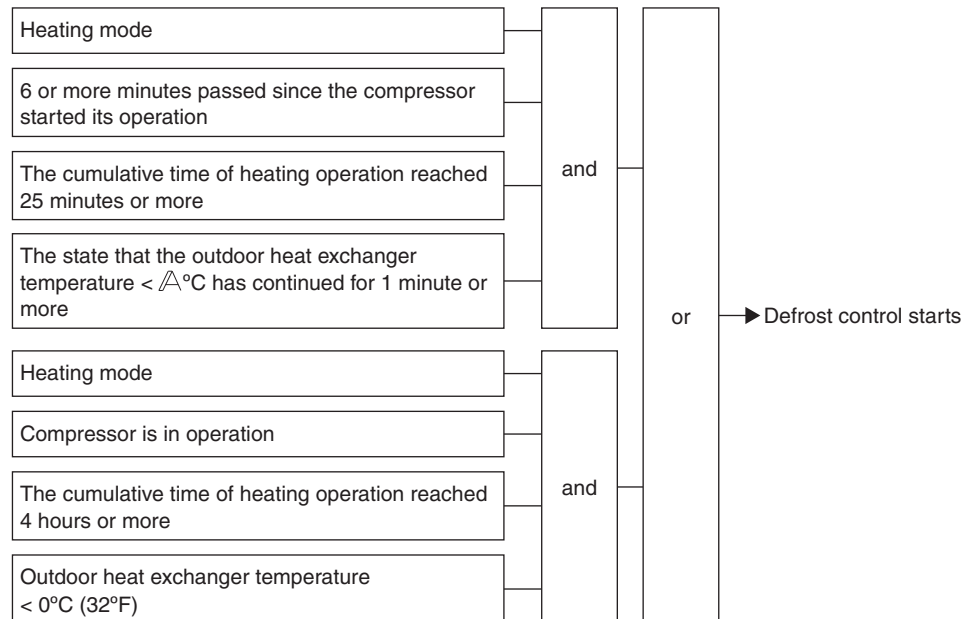

Δ (°C) is calculated by the following formula:

$$\Delta \text{ (}^\circ\text{C)} = -17/256 \times \text{compressor frequency} + 43/64 \times \text{outdoor air temperature} + \text{B (}^\circ\text{C)}$$

$$-20^\circ\text{C (-4}^\circ\text{F)} \leq \Delta \leq -4^\circ\text{C (24.8}^\circ\text{F)}$$

Time of the last defrost operation	B °C (°F)
short	-6 (21.2)
long	+4 (39.2)

NOTE: (°F) conversion temperatures are included for reference; the formula must be carried out in °C.

Operation during Defrosting and Termination Condition

- Operation should be conducted at 64Hz during defrosting.
- Defrosting operation must be conducted for 2 minutes, and after that, defrosting operation is conducted until the outdoor heat exchanger temperature reaches the defrost cancellation temperature at C°C .
- After the temperature has reached the defrost cancellation temperature, the defrosting should be terminated.

C°C is calculated by the following formula:

$$\text{C}^{\circ}\text{C} = 18 - 22/64 \times \text{outdoor air temperature } (^{\circ}\text{C})$$

However, when the calculated value is outside the range between 6°C (42.8°F) and 20°C (68°F), if it is less than 6°C (42.8°F), 6 (42.8) should be adopted and if it is more than 20°C (68°F), 20 (68) is adopted, as the defrost cancellation temperature. **Defrosting Time Chart:**

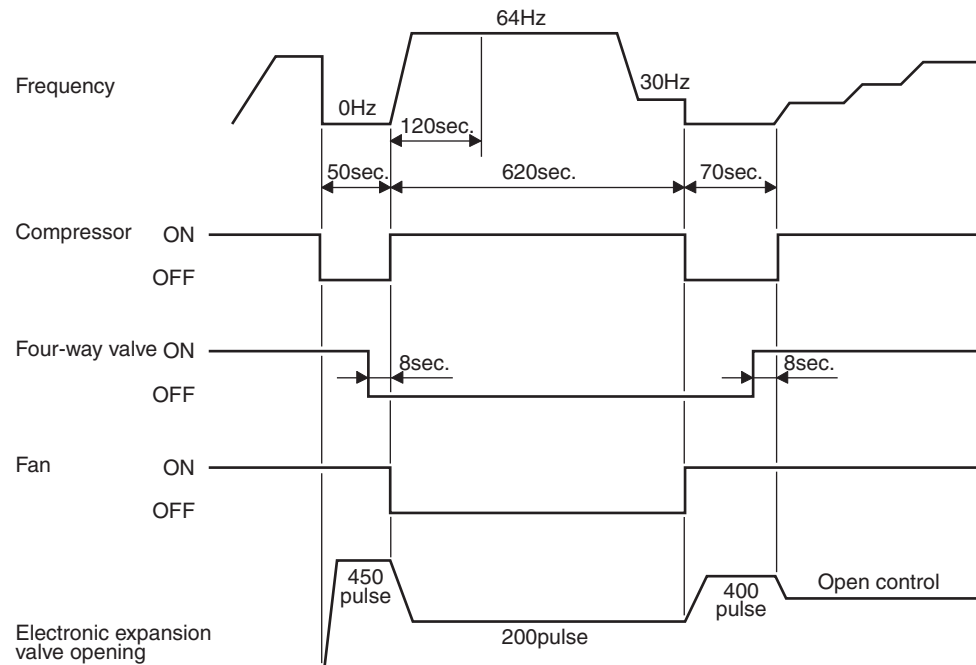

NOTE: ($^{\circ}\text{F}$) conversion temperatures are included for reference; the formula must be carried out in $^{\circ}\text{C}$.

3.14 Electronic Expansion Valve Control

Outline

The following items are included in the electronic expansion valve control.

Electronic expansion valve is fully closed

- ♦ Electronic expansion valve is fully closed when turning on the power.
- ♦ Pressure equalizing control

Open Control

- ♦ Electronic expansion valve control when starting operation
- ♦ Control when frequency changed
- ♦ Control for defrosting (only for heat pump model)
- ♦ Control when a discharge pipe temperature is abnormally high
- ♦ Control when the discharge pipe thermistor is disconnected

Feedback Control

- ♦ Discharge pipe temperature control

- Maximum electronic expansion valve opening : 470 pulses
- Minimum electronic expansion valve opening : 52 pulses

Details

The gray squares indicate which secondary functions are active or can be activated.

Operation pattern	Main operation control	Control when frequency is changed	Control for abnormally high discharge temperature
Power ON	Power initialization control	—	—
Cooling 1 room operation	Control when starting	—	○
	Control of target discharge temp.	○	○
Stop	Pressure equalization control	—	—
Heating 1 room operation	Control when starting	—	○
	Control of target discharge temp.	○	○
Stop	Pressure equalization control	—	—
Heating operation discharge sensor disconnected	Control when starting	—	○
	Control of target discharge temp.	—	—
Stop	pressure equalization control	—	—

3.14.1 Power Initialization Control

Outline

When turning on the power to the unit, the expansion valve is initialized to a certain starting position.

Details

At initialization the following steps are executed.

- ◆ The electronic expansion valve is closed by 700 pulses (to make sure it is closed shut).
- ◆ After closing the valve, it is opened again by 400 pulses.

3.14.2 Control when Starting

Outline

When the unit is switched on, some adjustments to the expansion valve opening have to be made in order to prevent excessive heating or moisture.

Cooling

$$EV = K_{evopf} \times \Delta F_{com} + K_{evopdce} \times DA + K_{evopdoa} \times DOA + P_5$$

Heating

In 2 min. from the operation starts.

$$EV = K_{evopf} \times \Delta F_{com} + P_5$$

After 2 min. from the operation starts.

$DOA \leq d_{oaopf}$	$EV = K_{evopf} \times \Delta F_{com} + P_5$
$d_{oaopf} < DOA \leq d_{oaopf} + dd_{oaopf}$	$EV = K_{evopf} \times \Delta F_{com} + P_5 + K_{evopdoa} \times (DOA - d_{oaopf})$
$d_{oaopf} + dd_{oaopf} < DOA$	$EV = K_{evopf} \times \Delta F_{com} + P_5 + K_{evopdoa} \times dd_{oaopf}$

Ending Condition

After 6 minutes from the time compressor starts.

or

Discharge temperature(°C) + 6 > condensation temperature (°C) > (36°C) (96.8°F)

K_{evopf}	: A constant depending on the outdoor unit type
P_5	: A constant depending on the outdoor unit type
$K_{evopdce}$: A constant depending on the outdoor unit type
$K_{evopdoa}$: A constant depending on the outdoor unit type
d_{oaopf}	: A constant
dd_{oaopf}	: A constant
D_A	: The room temperature (°C)
D_{OA}	: The outdoor temperature (°C)
ΔF_{com}	: Compressor frequency change

3.14.3 Control when Frequency is Changed**Outline**

Because the operation frequency is one of the variables in the calculation of the original opening of the expansion valve, the opening will have to be recalculated when the operation frequency is changed. During this recalculation, the target discharge temperature control will be deactivated.

Details

This control will engage when the operation frequency is changed during the target discharge temperature control. When this happens, a 10 seconds timer is set. Once this timer expires, the expansion valve opening is recalculated using the formulas below:

$$PHNHZ = PHNHZZ + KEVOPF \times (FMK - FMKZ)$$

Where:

PHNHZZ = expansion valve opening before change

PHNHZ = expansion valve opening after change

KEVOPF = constant value (cooling : 2.7, heating : 2.0)

FMK = operation frequency after change

FMKZ = operation frequency before change

The expansion valve opening is only changed when $FMK - FMKZ > 4$.

3.14.4 Superheat (SH) is required to ensure that only gas and not liquid enters the compressor. Because of the direct link between the SH and the discharge temperature (see the following figure show the target discharge temperature), a control on the discharge temperature was made to be one of the main control systems of Daikin airconditioners. The **Target Discharge Pipe Temperature Control**

Outline

Superheat (SH) is required to insure that only gas and not liquid is sucked up by the compressor. Because of the direct link between the SH and the discharge temperature (see Fig. target discharge temperature), a control on the discharge temperature was made to be one of the main control systems of Daikin air-conditioners. The discharge temperature and SH are regulated by the expansion valve.

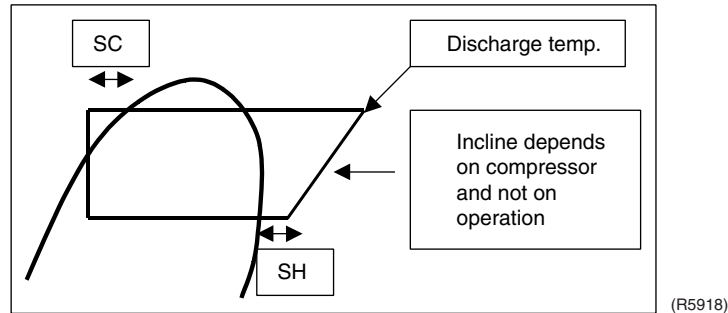

Fig.: Target discharge pipe temperature control graph

Details

The adjustment to the expansion valve opening is determined by the difference between the actual discharge temperature and the target discharge temperature.

Starting conditions for this operation are:

- ◆ The starting control and the 'operation room change' control (only for multi system) are inactive.
- ◆ The frequency changing control, high discharge temperature control and disconnected discharge thermistor control are inactive
- ◆ The defrost operation is inactive
- ◆ The compressor is active

Target discharge temperature = $\alpha \times$ condensing temperature – $\beta \times$ evaporating temperature + γ

α, β, γ ; predetermined constants related to different model types.

Discharge temp > target discharge temp, exp. valve will open.

Discharge temp < target discharge temp, exp. valve will close.

The target superheat (SH) will be 5°C ~ 7°C (9°F ~ 12.6°F) in cooling operation and 0°C (0°F) in heating operation. The discharge superheat always have to be larger than 10°C (18°F). Otherwise the unit will have liquid compression. (depends on compressor type)

3.14.5 Pressure Equalization Control

Outline

The pressure difference between both sides of the expansion valve works as an extra load when restarting the compressor. To limit the load on the compressor when restarting it and consequently limit the starting current, a pressure-equalization is performed after deactivating the compressor. Pressure equalization is achieved by opening the expansion valve to a certain level and then closing it again.

Details

As soon as the compressor is stopped due to an OFF command, the expansion valve valve is controlled as following.

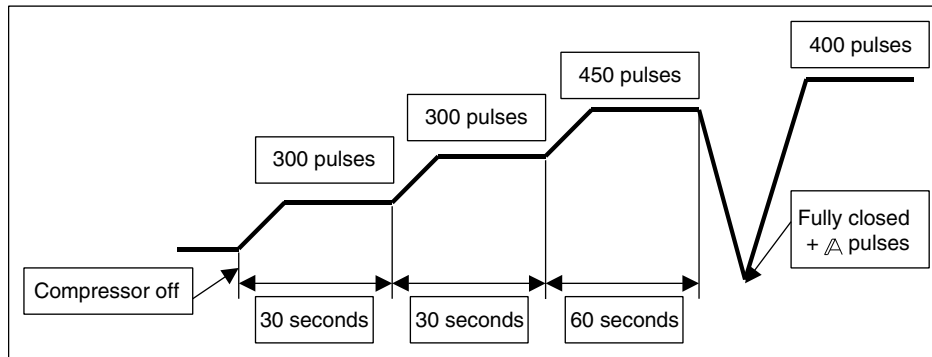

(R5919)

Fig.: Pressure equalization control graph in cooling mode

	Δ
OFF command by remote controller, mode change	24
Thermostat OFF	0

3.14.6 Control for Abnormally High Discharge Temperature

Outline

An abnormally high discharge temperature is an indication for a too high suction temperature or super-heat. Making adjustments to the expansion valve opening can solve this problem.

Details

Increasing the expansion valve opening will increase the refrigerant flow through the evaporator and decrease the superheat and the discharge temperature.

The unit is operating in the 'dropping zone' when all the following conditions are met:

- The compressor is operating
- the discharge temperature exceeds Δ °C

The unit is operating in the 'reset zone' when one of the following conditions are met:

- The compressor has stopped
- the discharge temperature is below B °C

Δ = 104 - correction value (a)

B = 100 - correction value (a)

For the correction value (a), refer to Page 45 *High Discharge Pipe Temperature Control*.

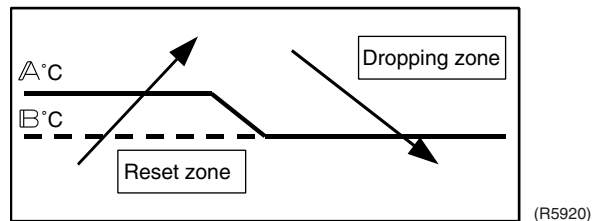

Fig.: Abnormal high discharge temperature control graph

In the dropping zone the unit will react as follows:

- Prohibit the discharge pipe temperature control
- When entering the dropping zone from the reset zone, it will add 20 pulses the expansion valve opening and set a 30 seconds 'opening adjustment timer'.
- Each time the opening adjustment timer reaches zero without leaving the dropping zone, 20 pulses will be added to the expansion valve opening and the opening adjustment timer will be reset.

Part 5

System Configuration

1. Installation Manual	54
1.1 Indoor Units	54
1.2 Outdoor Units	64
2. System Configuration	70
3. Instruction	71
3.1 Remote Controller	71
3.2 Cooling · QUATERNITY DRYING Operation	73
3.3 Heating Operation	74
3.4 AUTO Operation	75
3.5 FLASH STREAMER AIR PURIFYING · POWERFUL Operation	76
3.6 Adjusting Airflow Direction · Airflow Rate	77
3.7 COMFORT AIRFLOW · COOLING BREEZE Operation	78
3.8 TIMER Operation	79
3.9 COMFORT SLEEP Operation	80
3.10 SET UP · CHILD PROOF LOCK	81
3.11 INFORMATION DISPLAY	82

1. Installation Manual

1.1 Indoor Units

Indoor Unit Installation Drawings

1. Removing and installing indoor unit.

• Installation method

- 1) Using the Δ marks (3 locations) on top of the indoor unit, attach the $\text{\textcircled{A}}$ mounting plate hooks onto the indoor unit.
- 2) Attach the tabs on the bottom frame onto the $\text{\textcircled{A}}$ mounting plate. If the tabs are not hooked onto the plate, remove the front grille to hook them. (Check to see if the tabs are hooked securely.)

• Removal method

Push up the mark part on the bottom of the front grille, discharge the tabs, and then remove the unit while lifting it up.

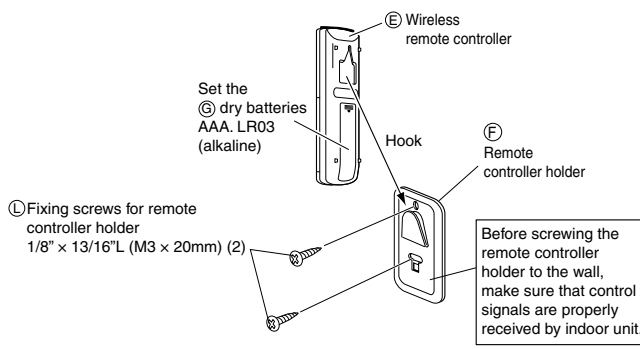
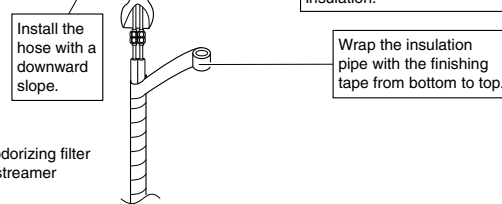
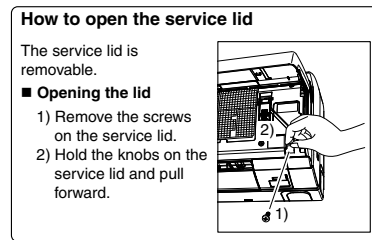
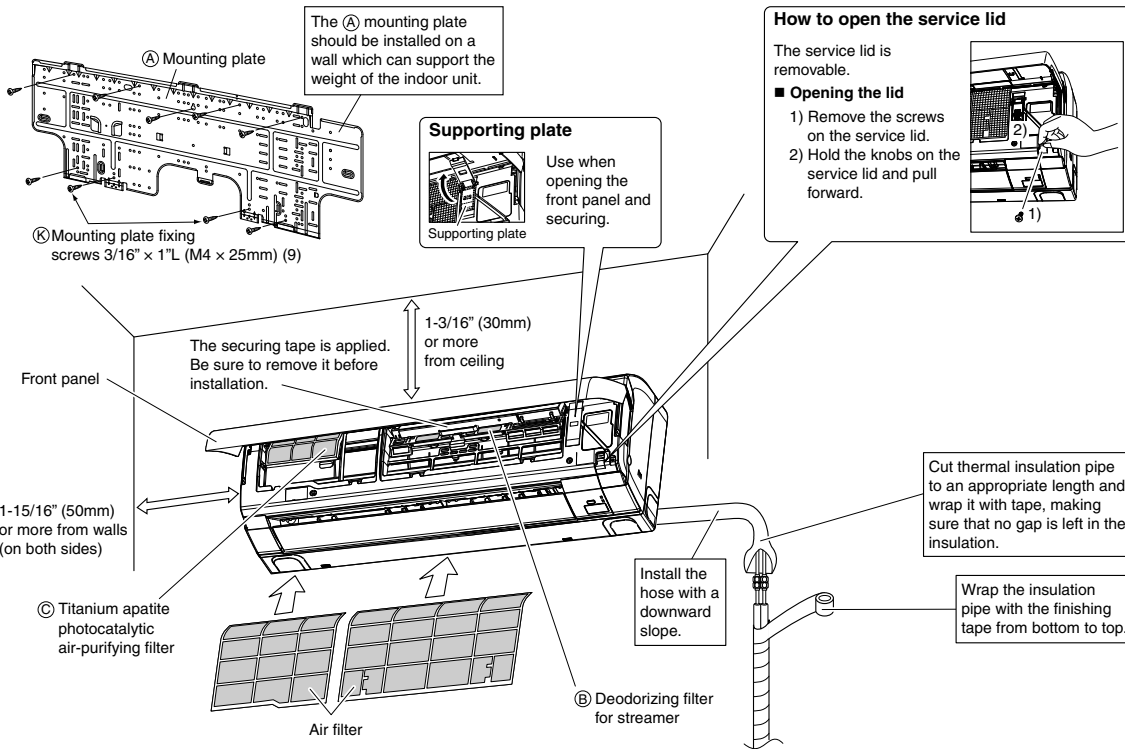
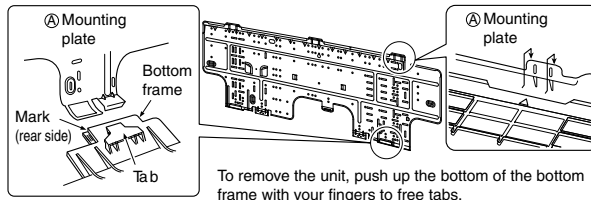

Installation Tips

1. Removing and installing front panel.

• Removal method

- 1) Open the front panel.
- 2) Spread out the shaft hole on the left side and remove the rotating shaft.
Spread out the shaft hole on the right side as well and remove the rotating shaft.

• Installation method

- Insert the right and left rotating shafts on the front panel into the shaft holes one at a time and slowly close the panel.
(Press on both sides of the front panel.)

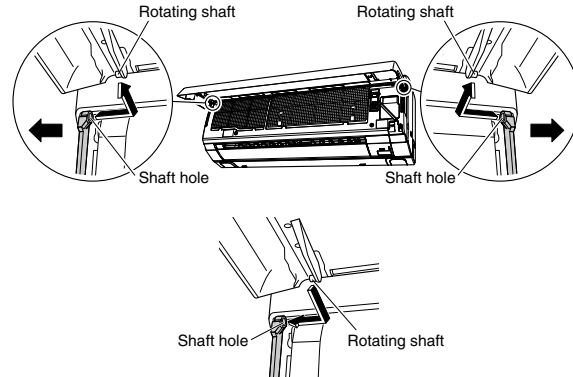

2. Removing and installing the upper panel.

• Removal method

- 1) Remove the front panel and air filter.
- 2) Hold and pull forward 2 tabs on both sides to disengage them, then disengage the center tab, and then lift up the upper panel.

• Installation method

- 1) Push in the upper panel along the guide on the top of the front grille and insert the 3 tabs into the slots on the front grille.
- 2) Push the upper panel down until it clicks.
- 3) Attach the air filter and front panel.

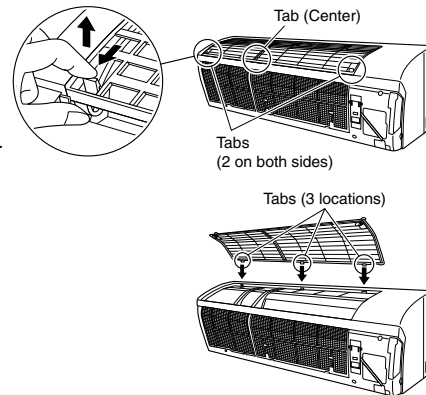

3. Removing and installing the front grille.

• Removal method

- 1) Remove the front panel, air filter and upper panel.
- 2) Fully open the top and bottom horizontal louvers. (See Fig. 1)
- 3) Remove the 3 screws in the front grille.
- 4) Lift the hooks (3 locations) on the front grille with a flathead screwdriver to discharge the tab.
(Look for the ○○○ mark.) (See Fig. 2)
- 5) Pull forward the front grille to remove.

• Installation method

- 1) Open the top louver fully and close the bottom louver fully.
- 2) Store the gear case arm in the front grille. (See Fig. 3)
- 3) Attach the front grille to the lower part of the unit.
(Use caution not to pinch the horizontal louver.)
- 4) Make sure to firmly latch the top hooks (3 locations).
- 5) Tighten with the 3 front grille screws.
- 6) Attach the upper panel, air filter and front panel.

Fig. 3

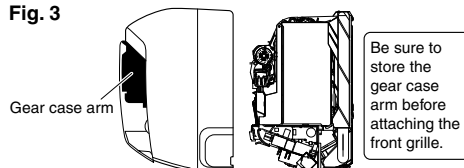

Fig. 1

Horizontal louver

When removing or attaching the front grille, pay attention to open or close of each horizontal louver.

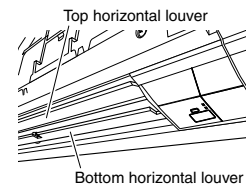
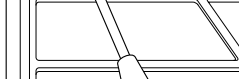

Fig. 2

Hooks on the front grille

○○○ mark area (3 locations)

CAUTION
Use caution to prevent the front grille from breaking.



○○○ mark area (3 locations)

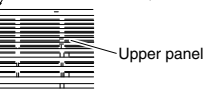

4. Installing the titanium apatite photocatalytic air-purifying filter and deodorizing filter for streamer.

- 1) Open the front panel to pull out the air filter.
- 2) Attach the ㉟ titanium apatite photocatalytic air-purifying filter.
- 3) Attach the ㊸ deodorizing filter for streamer.
- 4) Replace the air filter to its original position and close the front panel.

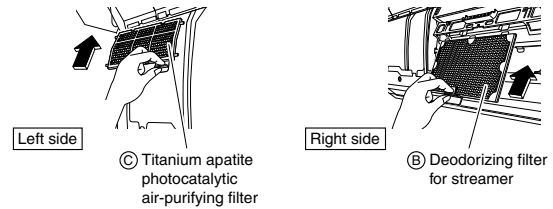

5. How to replace the drain plug and drain hose.

• Replacing onto the left side

- 1) Remove the insulation fixing screws on the right to remove the drain hose.
- 2) Reattach the insulation fixing screw on the right as it was.
*(Forgetting to attach this may cause water leakages.)
- 3) Remove the drain plug on the left side and attach it to the right side.
- 4) Insert the drain hose and tighten with included ㉞ indoor unit fixing screw.

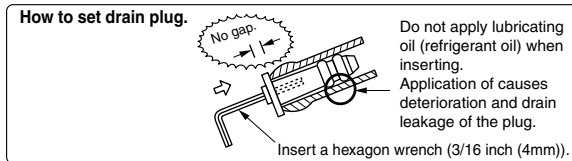
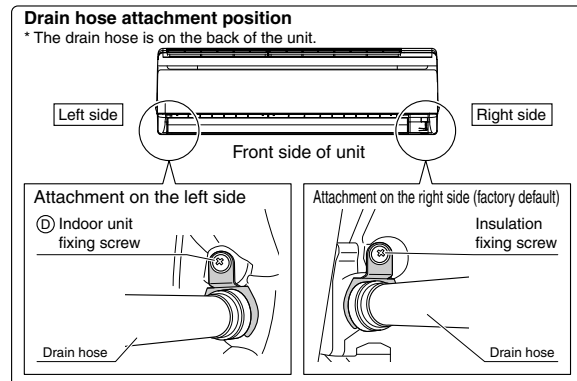

6. How to set the different addresses.

- When 2 indoor units are installed in 1 room, the 2 wireless remote controllers can be set for different addresses.

- 1) Remove the front grille. (3 screws)
- 2) Cut the address jumper "JA". (See Fig. 1)

Fig. 1

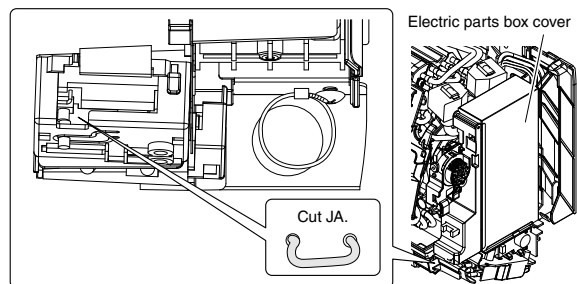

- 3) Remove the remote controller lid and cut the address jumper "J4". (See Fig. 2)

Fig. 2

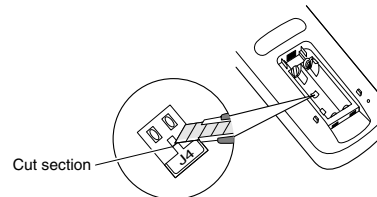

Indoor Unit Installation

1. Installing the mounting plate.

- The Ⓐ mounting plate should be installed on a wall which can support the weight of the indoor unit.
 - Temporarily secure the Ⓐ mounting plate to the wall, make sure that the panel is completely level, and mark the fixing points on the wall.
 - Secure the Ⓐ mounting plate to the wall with screws.

Recommended mounting plate retention spots and Dimensions

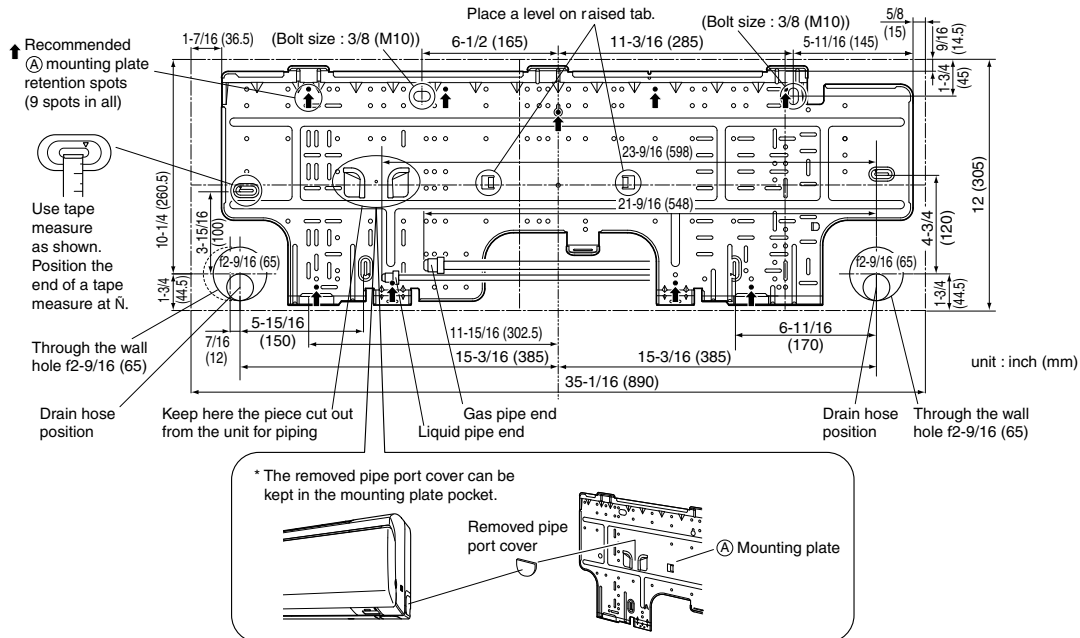

2. Boring a wall hole and installing wall embedded pipe.

- For walls containing metal frame or metal board, be sure to use a wall embedded pipe and wall cover in the feed-through hole to prevent possible heat, electrical shock, or fire.
- Be sure to caulk the gaps around the pipes with caulking material to prevent water leakage.
 - Bore a feed-through hole of f2-9/16 inch (65mm) in the wall so it has a down slope toward the outside.
 - Insert a wall pipe into the hole.
 - Insert a wall cover into wall pipe.
 - After completing refrigerant piping, wiring, and drain piping, caulk pipe hole gap with putty.

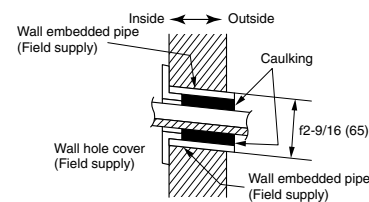

3. Installing inter-unit wiring.

- Open the front panel and remove the service lid.
- Pull out the inter-unit wiring from the back of the indoor unit to the front. It is easier to pull out if bending up the wire edge in advance.
- To connect the inter-unit wiring after hooking the unit onto the Ⓐ mounting plate, connect the inter-unit wiring as shown in the figure at right.

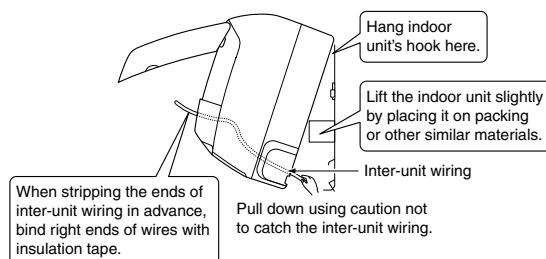

4. Laying piping and wiring.

- Lay the piping and drain hose according to the orientation of the piping coming out of the unit, as shown below.
- Make sure the drain hose is sloped downward.
- Wrap the piping and drain hose together using insulation tape.

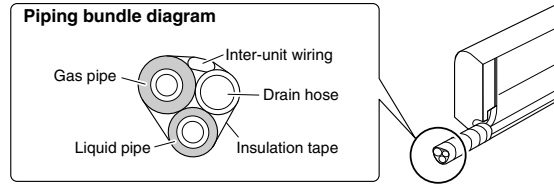

4-1. Right-side, right-back, or right-bottom piping.

• Right-side piping

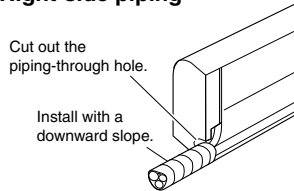

• Right-back piping

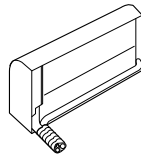

• Right-bottom piping

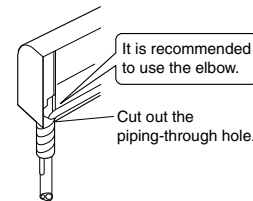

- 1) Wrap the piping and inter-unit wiring using insulation tape as shown in the piping bundle diagram.
- 2) Put all the pipes through the through-hole in the wall and hook the indoor unit onto the (A) mounting plate.
- 3) Connect the pipes.

4-2. Left-side, left-back, or left-bottom piping.

• Left-side piping

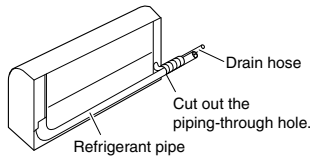

• Left-back piping

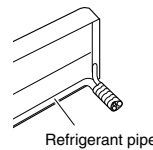

• Left-bottom piping

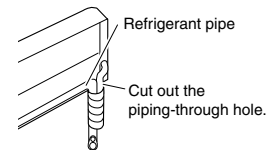

- 1) Replace the drain plug and drain hose. (**How to replace the drain plug and drain hose.**)
- 2) Pull in the refrigerant piping and lay it so that it matches the liquid and gas piping marked on the (A) mounting plate.
- 3) Hook the indoor unit onto the (A) mounting plate.
- 4) Connect the pipes. If it is difficult to do, remove the front panel first.
- 5) Wrap the insulation on the piping with insulation tape. If you are not repositioning the drain hose, store it in the location shown below.

When securing the indoor unit with screws

- 1) Remove the front grille.
- 2) Secure the indoor unit with the (D) indoor unit fixing screws.
- 3) Install the front grille.

(D) 3/16" × 1/2"L (M4 × 12mm)

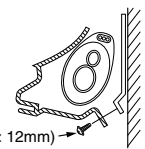

4-3. Left-back piping.

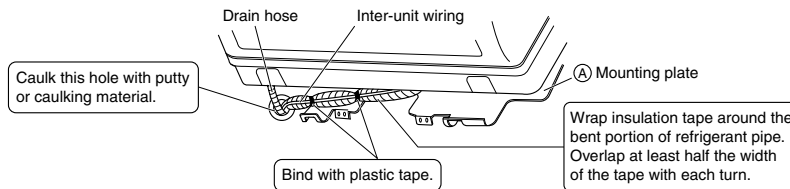

Indoor Unit Installation

4-4. Wall embedded piping.

Follow the instructions given under

Left-side, left-back, or left-bottom piping

- 1) Insert the drain hose to this depth so it won't be pulled out of the drain pipe.

Insert drain hose to this depth so it won't be pulled out of drain pipe.

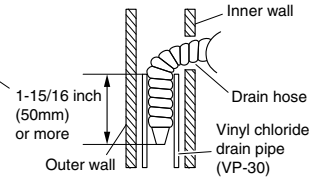

⚠ WARNING

Do not bundle the power code with a binding band, a twist tie or other method. This may cause heat, electric shock or fire.

5. Wiring

- 1) Strip the insulation from the wire (3/4 inch (20mm)).
- 2) Match wire colors with terminal numbers on indoor and outdoor unit's terminal blocks and firmly screw wires to the corresponding terminals.
- 3) Connect the ground wires to the corresponding terminals.
- 4) Pull the wires to make sure that they are securely connected, and retain the wires with the binding band as shown in the illustration below.
- 5) In case of connecting to an adapter system. Run the remote controller cable and attach the S21. (Refer to 6. **Connecting to the HA system.**)
- 6) Shape the wires so that the service lid fits securely, then close service lid.

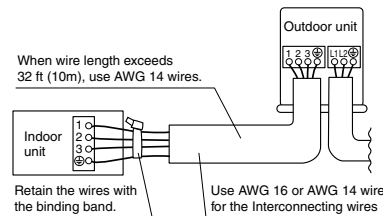
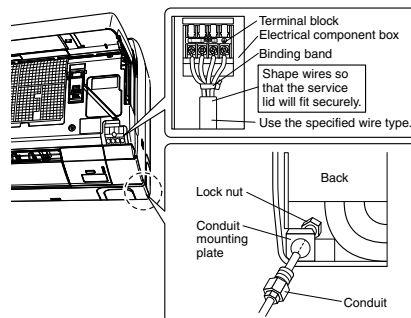

⚠ WARNING

- 1) Do not use tapped wires, strand wires, extension cords or starburst connections, as they may cause overheating, electrical shock, or fire.
- 2) Do not use locally purchased electrical parts inside the product. (Do not branch the power for the drain pump, etc., from the terminal block.) Doing so may cause electric shock or fire.
- 3) When carrying out wiring connection, take care not to pull at the conduit.

6. Connecting to the HA system.

- 1) Remove the front grille. (3 screws)
- 2) Remove the decelerator assembly parts. (1 screw)
 - 2-1) Remove the decelerator assembly part screws. (See Fig. 1)
 - 2-2) Remove the decelerator assembly part connector. Remove by pressing on the tabs on the bottom of the connector. (See the tab position diagram 1)
- 3) Remove the electric parts box. (1 screw, 2 tabs)
 - 3-1) Remove the electric parts box fixing screw.
 - 3-2) Pull the electric parts box toward you and disengage Tab 2.

Fig. 1

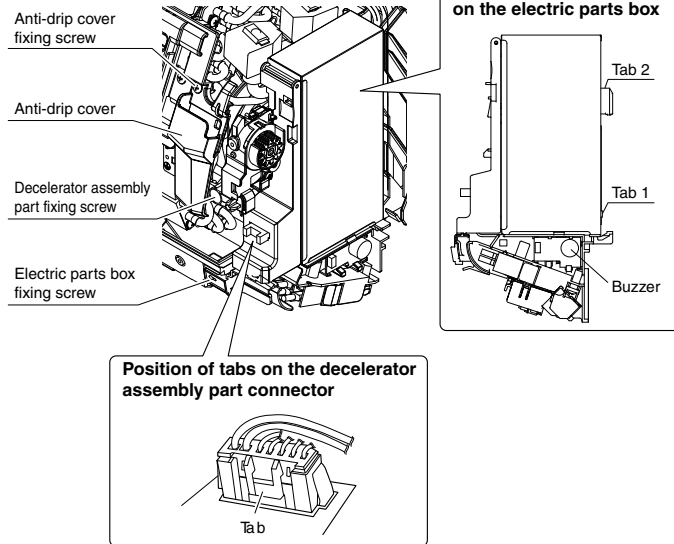

- 4) Remove the electric parts box cover. (3 tabs) (Refer to Fig. 2)
 - 4-1) Disengage Tab 3.
 - 4-2) Pull up the electric parts box cover slowly, disengage Tab 4, slide up, and disengage Tab 5.
- 5) Insert the connection cord into the HA connector "S21."

Fig. 2

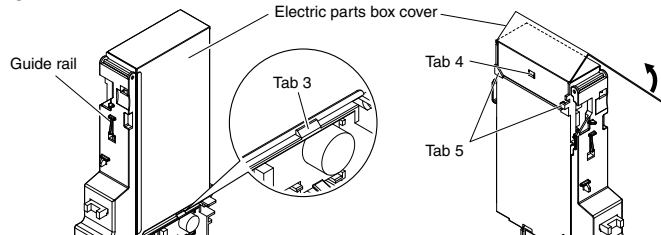

- 6) Lay the connection cord as shown in Fig. 3.
- 7) Replace the electric parts box cover and electric parts box as they were.
- 8) Attach the decelerator assembly part along with the guide rail. (Refer to Fig. 2)
- 9) Install the front grille.

Fig. 3

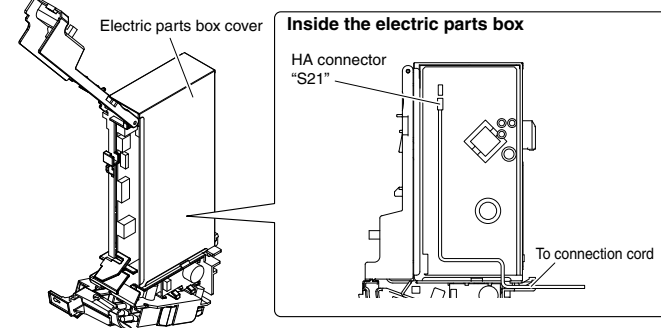

Indoor Unit Installation

7. Drain piping.

1) Connect the drain hose, as described right.

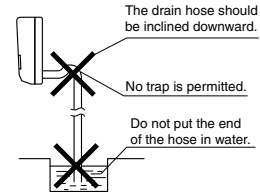

2) Remove the air filters and pour some water into the drain pan to check the water flows smoothly.

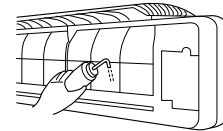

3) When drain hose requires extension, obtain an extension hose commercially available. Be sure to thermally insulate the indoor section of the extension hose.

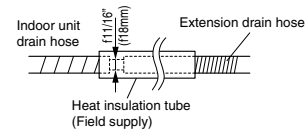

4) When connecting a rigid polyvinyl chloride pipe (nominal diameter 1/2 inch (13mm) directly to the drain hose attached to the indoor unit as with embedded piping work, use any commercially available drain socket (nominal diameter 1/2 inch (13mm) as a joint.

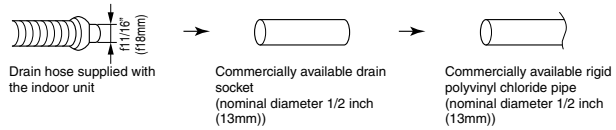

8. Improving installation strength.

- We recommend screwing the indoor unit onto a ① mounting plate in order to improve the installation strength.

- 1) Remove the front grille.
- 2) Screw in the indoor unit with ② fixing screws.
- 3) Attach the front grille.

Screw position
Front diagram

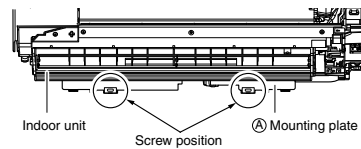

Enlarged diagram

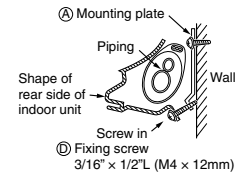

Refrigerant Piping Work

1. Flaring the pipe end.

- 1) Cut the pipe end with a pipe cutter.
- 2) Remove burrs with the cut surface facing downward so that the chips do not enter the pipe.
- 3) Put the flare nut on the pipe.
- 4) Flare the pipe.
- 5) Check that the flaring is properly made.

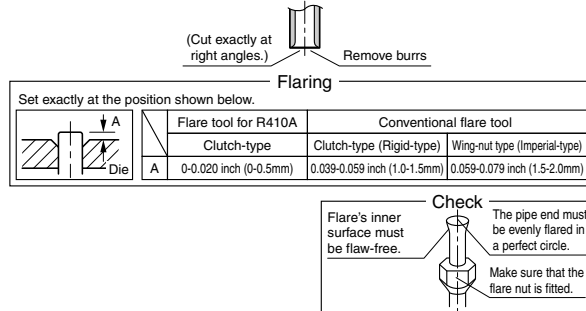

⚠ WARNING

- 1) Do not use mineral oil on flared part.
- 2) Prevent mineral oil from getting into the system as this would reduce the lifetime of the unit.
- 3) Never use piping which has been used for previous installations. Only use parts which are delivered with the unit.
- 4) Never install a drier to this R410A unit in order to guarantee its lifetime.
- 5) The drying material may dissolve and damage the system.
- 6) Incomplete flaring may cause refrigerant gas leakage.

2. Refrigerant piping

⚠ CAUTION

- 1) Use the flare nut fixed to the main unit. (To prevent cracking of the flare nut by age deterioration.)
- 2) To prevent gas leakage, apply refrigeration oil only to the inner surface of the flare. (Use refrigeration oil for R410A.)
- 3) Use torque wrenches when tightening the flare nuts to prevent damage to the flare nuts and gas leakage.

Align the centers of both flares and tighten the flare nuts 3 or 4 turns by hand. Then tighten them fully with the torque wrenches.

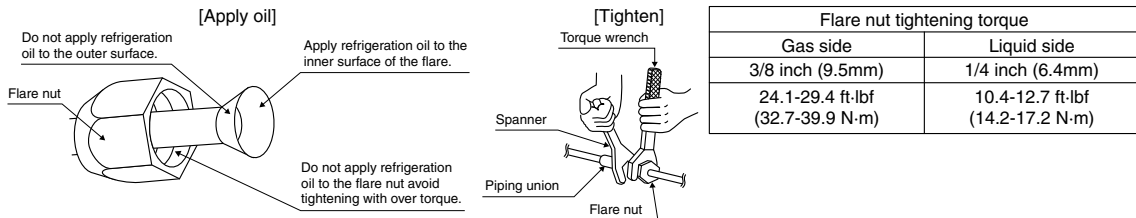

2-1. Caution on piping handling.

- 1) Protect the open end of the pipe against dust and moisture.
- 2) All pipe bends should be as gentle as possible. Use a pipe bender for bending.

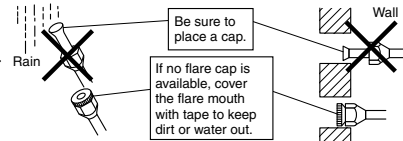

2-2. Selection of copper and heat insulation materials.

- When using commercial copper pipes and fittings, observe the following:

- 1) Insulation material: Polyethylene foam
Heat transfer rate: 0.041 to 0.052W/mK (0.024 to 0.030 Btu/ft²h°F (0.035 to 0.045 kcal/mh°C))
Refrigerant gas pipe's surface temperature reaches 230°F (110°C) max.
Choose heat insulation materials that will withstand this temperature.

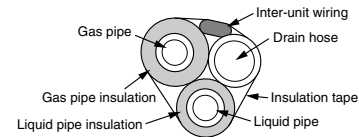

- 2) Be sure to insulate both the gas and liquid piping and to provide insulation dimensions as below.

Gas side	Liquid side	Gas pipe thermal insulation	Liquid pipe thermal insulation
O.D. 3/8 inch (9.5mm)	O.D. 1/4 inch (6.4mm)	I.D. 0.472-0.590 inch (12-15mm)	I.D. 0.315-0.393 inch (8-10mm)
Minimum bend radius		Thickness 0.393 inch (10mm) Min.	
1-3/16 inch (30mm) or more			
Thickness 0.031 inch (0.8mm) (C1220T-O)			

- 3) Use separate thermal insulation pipes for gas and liquid refrigerant pipes.

Trial Operation and Testing

1. Trial operation and testing.

1-1. Measure the supply voltage and make sure that it falls in the specified range.

1-2. Trial operation should be carried out in either cooling or heating mode.

- In cooling mode, select the lowest programmable temperature; in heating mode, select the highest programmable temperature.
 - 1) Trial operation may be disabled in either mode depending on the room temperature.
Use the remote controller for trial operation as described below.
 - 2) After trial operation is complete, set the temperature to a normal level 26°C to 28°C (78°F to 82°F) in cooling mode, 20°C to 24°C (68°F to 75°F) in heating mode.
 - 3) For protection, the system disables restart operation for 3 minutes after it is turned off.

1-3. Operate the unit in accordance with the operation manual to check that it operates normally.

- Even when the air conditioner is not operating, it consumes some electric power. If the customer is not going to use the unit soon after it is installed, turn off the breaker to avoid wasting electricity.

Trial operation from remote controller

- 1) Hold the "CLOCK button" for 5 seconds.
(The matrix display will appear on the remote controller.)
- 2) Display "SETTING" on the matrix display of the remote controller and press the "CLOCK button".

- 3) "7-" will be displayed and the unit will enter test run mode.
- 4) Press the button for test run mode.
 - Test run mode will stop automatically after around 30 minutes.
Press the ON/OFF button to force the test-run to stop.

2. Test items.

Test items	Symptom (diagnostic display on RC)	Check
Indoor and outdoor units are installed properly on solid bases.	Fall, vibration, noise	
Did you install the deodorizing filter for the streamer and the titanium apatite photocatalytic air-purifying filter?	Noise, water leakage	
Have you performed a gas leak test?	Incomplete cooling/heating function	
No refrigerant gas leaks.	Incomplete cooling/heating function	
Refrigerant gas and liquid pipes and indoor drain hose extension are thermally insulated.	Water leakage	
Draining line is properly installed.	Water leakage	
Does the drain hose produce abnormal noise (perking sound) when using the ventilation fan or others?	Use of separately sold air cut drain plug	
System is properly ground to earth.	Electrical leakage	
The specified wires are used for inter-unit wiring connections.	Inoperative or burn damage	
Indoor or outdoor unit's air intake or exhaust has clear path of air. Stop valves are opened.	Incomplete cooling/heating function	
Indoor unit properly receives remote controller commands.	Inoperative	
Did you check the address setting?	Inoperative	

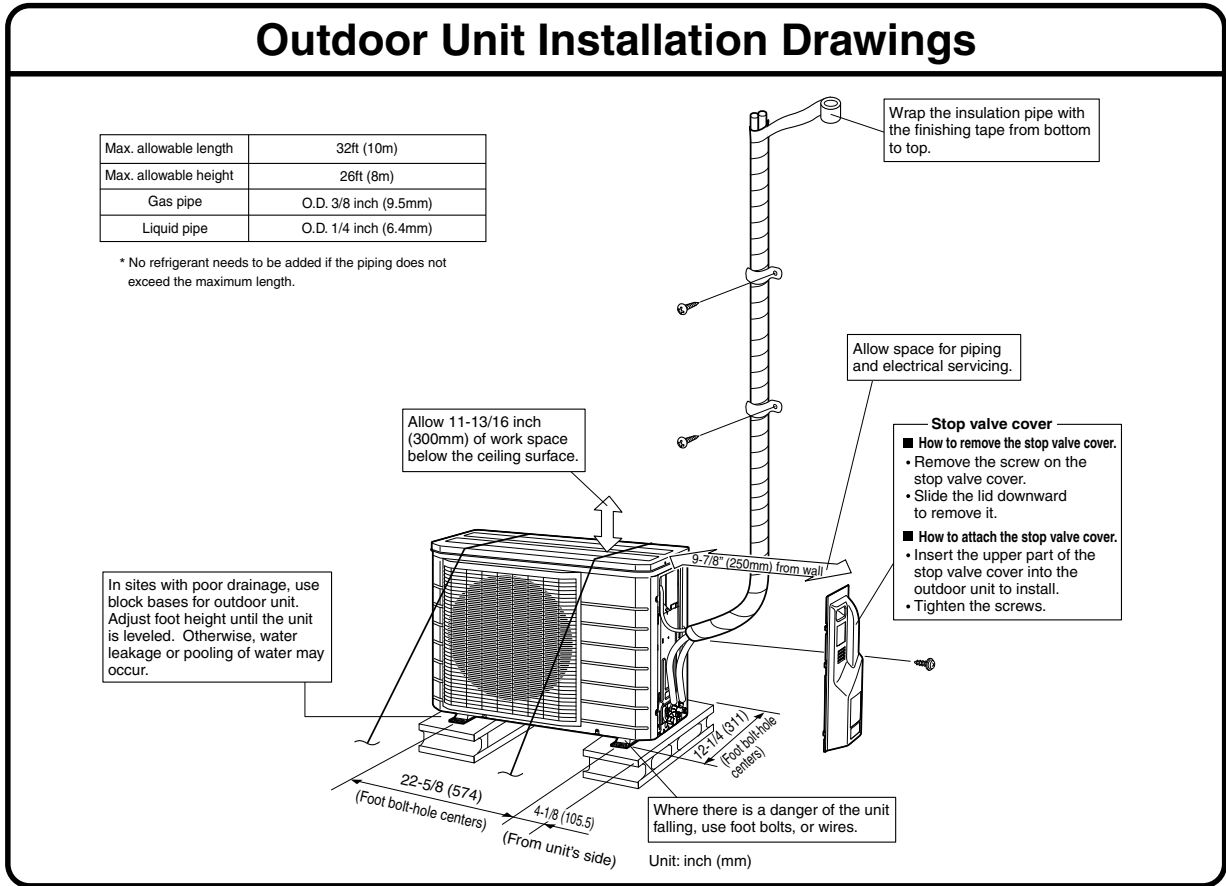
1.2 Outdoor Units



Outdoor Unit Installation (1)

1. Installing outdoor unit.

- 1) When installing the outdoor unit, refer to “Precautions for Selecting the Location” and the “Outdoor Unit Installation Drawings”.
- 2) If drain work is necessary, follow the procedures below.

2. Drain work (heat pump-models).

- 1) Use drain plug for drainage.
- 2) If the drain port is covered by a mounting base or floor surface, place additional foot bases of at least 1-1/4 inch (30mm) height under the outdoor unit's feet.
- 3) In cold areas, do not use a drain hose with the outdoor unit.
(Otherwise, drain water may freeze, impairing heating performance.)

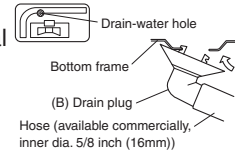

3. Flaring the pipe end.

- 1) Cut the pipe end with a pipe cutter.
- 2) Remove burrs with the cut surface facing downward so that the chips do not enter the pipe.
- 3) Put the flare nut on the pipe.
- 4) Flare the pipe.
- 5) Check that the flaring is properly made.

(Cut exactly at right angles.) Remove burrs

Flaring

Set exactly at the position shown below.

Flare tool for R410A	Conventional flare tool	
	Clutch-type	Wing-nut type (Imperial-type)
A	0-0.020 inch (0-0.5mm)	0.059-0.079 inch (1.5-2.0mm)

Check

Flare's inner surface must be flaw-free.

The pipe end must be evenly flared in a perfect circle.

Make sure that the flare nut is fitted.

WARNING

- 1) Do not use mineral oil on flared part.
- 2) Prevent mineral oil from getting into the system as this would reduce the lifetime of the units.
- 3) Never use piping which has been used for previous installations. Only use parts which are delivered with the unit.
- 4) Never install a drier to this R410A unit in order to guarantee its lifetime.
- 5) The drying material may dissolve and damage the system.
- 6) Incomplete flaring may cause refrigerant gas leakage.

4. Refrigerant piping.

CAUTION

- 1) Use the flare nut fixed to the main unit to prevent cracking of the flare nut by aged deterioration.
- 2) To prevent gas leakage, apply refrigeration oil only to the inner surface of the flare. Use refrigeration oil for R410A.
- 3) Use torque wrenches when tightening the flare nuts to prevent damage to the flare nuts and gas leakage.

Align the centers of both flares and tighten the flare nuts 3 or 4 turns by hand. Then tighten them fully with the torque wrenches.

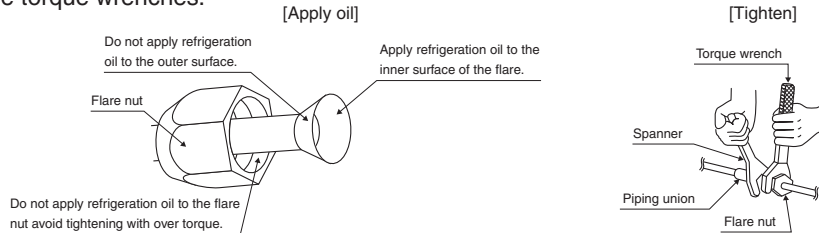

Flare nut tightening torque	
Gas side	Liquid side
3/8 inch (9.5mm)	1/4 inch (6.4mm)
24.1-29.4ft • lbf (32.7-39.9N • m)	10.4-12.7ft • lbf (14.2-17.2N • m)

Valve cap tightening torque	
Gas side	Liquid side
3/8 inch (9.5mm)	1/4 inch (6.4mm)
15.9-20.2ft • lbf (21.6-27.4N • m)	15.9-20.2ft • lbf (21.6-27.4N • m)

Service port cap tightening torque	7.9-10.8ft • lbf (10.8-14.7N • m)
------------------------------------	-----------------------------------

Outdoor Unit Installation (2)

5. Purging air and checking gas leakage.

- When piping work is completed, it is necessary to purge the air and check for gas leakage.

⚠ WARNING

- Do not mix any substance other than the specified refrigerant (R410A) into the refrigeration cycle.
- When refrigerant gas leaks occur, ventilate the room as soon and as much as possible.
- R410A, as well as other refrigerants, should always be recovered and never be released directly into the environment.
- Use a vacuum pump for R410A exclusively. Using the same vacuum pump for different refrigerants may damage the vacuum pump or the unit.

- If using additional refrigerant, perform air purging from the refrigerant pipes and indoor unit using a vacuum pump, then charge additional refrigerant.
- Use a hexagonal wrench (3/16 inch (4mm)) to operate the stop valve rod.
- All refrigerant pipe joints should be tightened with a torque wrench at the specified tightening torque.

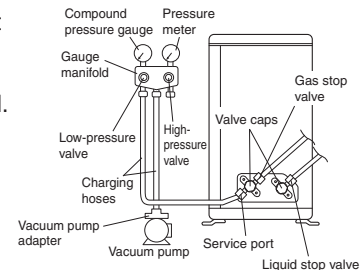

1) Connect projection side of charging hose (which comes from gauge manifold) to gas stop valve's service port.



2) Fully open gauge manifold's low-pressure valve (Lo) and completely close its high-pressure valve (Hi).
(High-pressure valve subsequently requires no operation.)



3) Do vacuum pumping and make sure that the compound pressure gauge reads 500 Microns.
(The vacuum pump should run for at least 10 min.)



4) Close gauge manifold's low-pressure valve (Lo) and stop vacuum pump.
(Keep this state for 20 minutes to make sure that the compound pressure gauge pointer does not swing back.)*1



5) Remove valve caps from liquid stop valve and gas stop valve.



6) Turn the liquid stop valve's rod 90 degrees counterclockwise with a hexagonal wrench to open valve.
Close it after 5 seconds, and check for gas leakage.
Using soapy water, check for gas leakage from indoor unit's flare and outdoor unit's flare and valve rods.
After the check is complete, wipe all soapy water off.



7) Disconnect charging hose from gas stop valve's service port, then fully open liquid and gas stop valves.
(Do not attempt to turn valve rod beyond its stop.)



8) Tighten valve caps and service port cap for the liquid and gas stop valves with a torque wrench at the specified torques.

*1. If the compound pressure gauge pointer swings back, refrigerant may have water content or a loose pipe joint may exist. Check all pipe joints and retighten nuts as needed, then repeat steps 2) through 4).

Outdoor Unit Installation (3)

6. Refilling the refrigerant.

Check the type of refrigerant to be used on the machine nameplate.

Precautions when adding R410A

Fill from the liquid pipe in liquid form.

It is a mixed refrigerant, so adding it in gas form may cause the refrigerant composition to change, preventing normal operation.

- 1) Before filling, check whether the cylinder has a siphon attached or not.
(It should have something like "liquid filling siphon attached" displayed on it.)

- Be sure to use the R410A tools to ensure pressure and to prevent foreign objects entering.

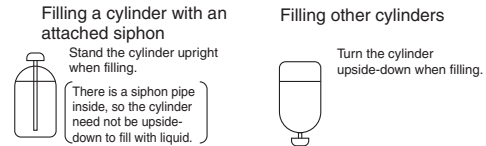

7. Refrigerant piping work.

7-1 Cautions on pipe handling.

- 1) Protect the open end of the pipe against dust and moisture.
- 2) All pipe bends should be as gentle as possible. Use a pipe bender for bending.

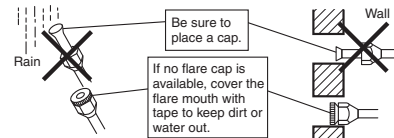

7-2 Selection of copper and heat insulation materials.

When using commercial copper pipes and fittings, observe the following:

- 1) Insulation material: Polyethylene foam
Heat transfer rate: 0.041 to 0.052W/mK / 0.035-0.045kcal/mh°C (0.024-0.030Btu/ftth°F)
Refrigerant gas pipe's surface temperature reaches 110°C (230°F) max.
Choose heat insulation materials that will withstand this temperature.
- 2) Be sure to insulate both the gas and liquid piping and to provide insulation dimensions as below.

Seal the edge of the insulation if there is a possibility that the condensation from the shut-off valve might drip onto the indoor unit through the gap between the insulation and the pipe.

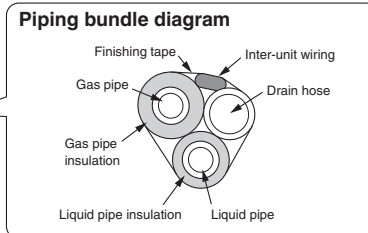
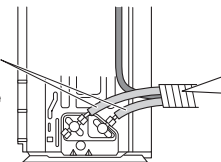

Gas side	Liquid side	Gas pipe thermal insulation	Liquid pipe thermal insulation
O.D. 3/8inch (9.5mm)	O.D. 1/4inch (6.4mm)	I.D. 0.472-0.590inch (12-15mm)	I.D. 0.315-0.393inch (8-10mm)
Minimum bend radius		Thickness 0.393inch (10mm) Min.	
1-3/16inch (30mm) or more			
Thickness 0.031inch (0.8mm) (C1220T-O)			

- 3) Use separate thermal insulation pipes for gas and liquid refrigerant pipes.

Pump Down Operation

In order to protect the environment, be sure to pump down when relocating or disposing of the unit.

- 1) Remove the valve caps from liquid stop valve and gas stop valve.
- 2) Carry out forced cooling operation.
- 3) After 5 to 10 minutes, close the liquid stop valve with a hexagonal wrench.
- 4) After 2 to 3 minutes, close the gas stop valve and stop forced cooling operation.

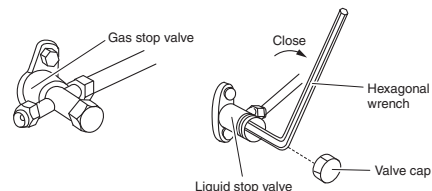

How to force cooling operation mode

■ Using the indoor unit operation/stop button

- Press the indoor unit operation/stop button for at least 5 seconds. (Operation will start.)
- Forced cooling operation will stop automatically after around 15 minutes.
- To force a test run to stop, press the indoor unit operation/stop button.



CAUTION

After closing the liquid stop valve, close the gas stop valve within 3 minutes, then stop the forced operation.

Wiring (1)

⚠ WARNING

- 1) Do not use spliced wires, stranded wires, extension cords, or starburst connections, as they may cause overheating, electrical shock, or fire. Follow all Local, and State electrical codes.
- 2) Do not use locally purchased electrical parts inside the product. (Do not overload the circuit by adding drain pump or other electrical equipment to unit terminals.) Doing so may cause electric shock or fire.
- 3) Be sure to install a ground leak detector (One that can handle higher harmonics.)
(This unit uses an inverter, which means that it must be used a ground leak detector capable of handling harmonics in order to prevent malfunctioning of the ground leak detector itself.)
- 4) Use an all-pole disconnection type breaker with at least 1/8 inch (3mm) between the contact point gaps.
- 5) The ground leakage circuit breaker must operate at 30mA or lower.
- 6) When carrying out wiring connection, take care not to pull at the conduit.

<Work before wiring>

A protection plate is fixed for protection from the high-voltage section.
Before starting wiring work, remove the 2 screws and the protection plate.

<Method of mounting conduit>

- 1) Pass wires through the conduit and secure them with a lock nut.
- 2) By removing the 2 screws to remove the conduit mounting plate, you can work without the plate.
- 3) Secure the wire with a binding band to the conduit mounting plate.
After completing the work, reattach the conduit mounting plate to its original position.

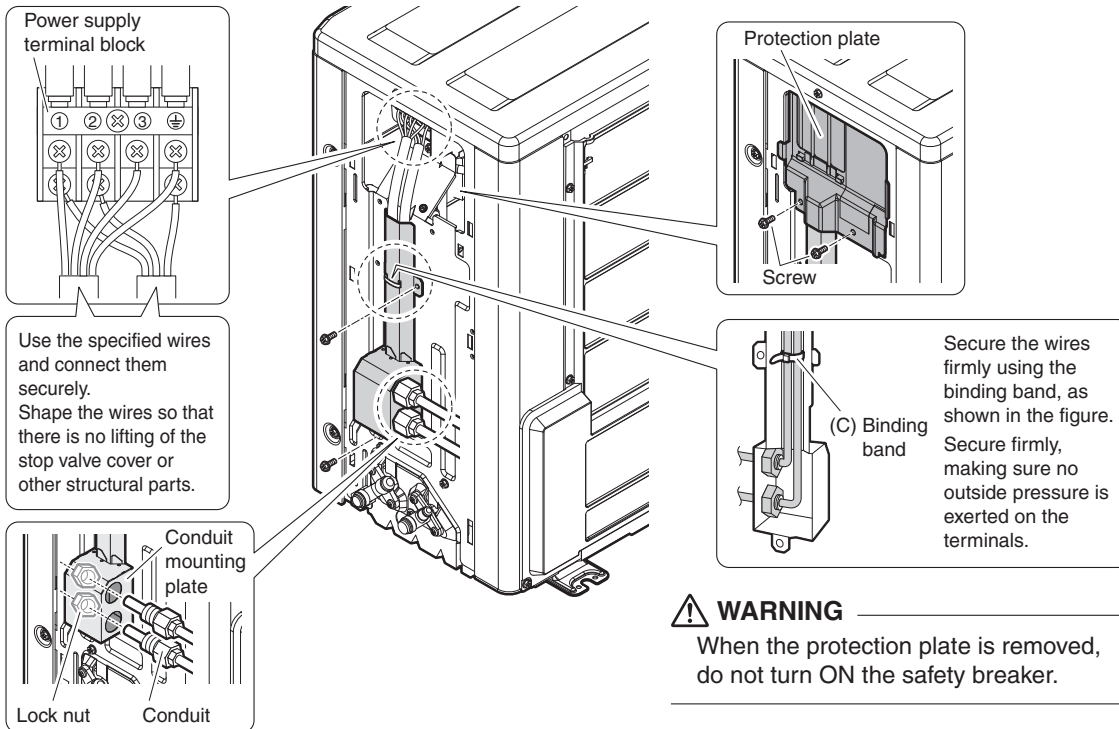

• Do not turn ON the safety breaker until all work is completed.

<Wiring procedure>

- 1) Strip the insulation from the wire (3/4 inch (20mm)).
- 2) Connect the connection wires between the indoor and outdoor units **so that the terminal numbers match**.
- 3) After completing wiring, fix the protection plate to its original position.

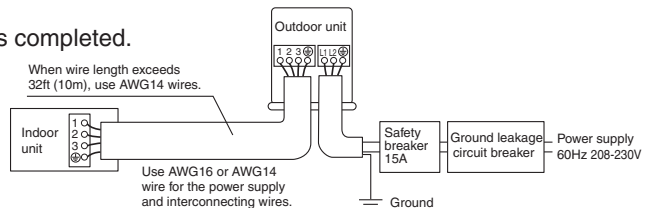

Wiring (2)

⚠ CAUTION (1)

In case using stranded wires is unavoidable for some reason, make sure to install the round crimp-style terminals on the tip.

Place the round crimp-style terminals on the wires up to the covered part and secure in place.



<Ground terminal installation>

1) Use the following method when installing a single core wire.

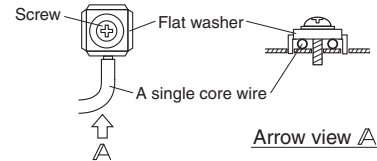

2) Use the following method when installing the round crimp-style terminal.

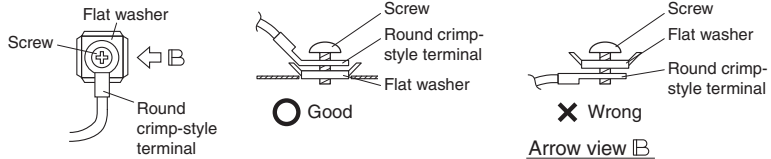

⚠ CAUTION (2)

When connecting the connection wires to the terminal board using a single core wire, be sure to perform curling. Problems with the work may cause heat and fires.

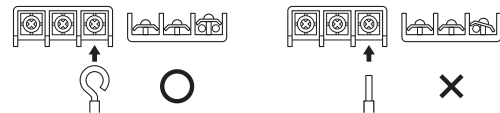

3) Pull the wire and make sure that it does not disconnect. Then fix the wire in place with a wire stop.

Test Run and Final Check

1. Trial operation and testing.

- Measure the supply voltage and make sure that it falls in the specified range.
- See “Test Run and Final Check” in the installation manual that came with the indoor unit for details on how to perform the test run and what to check for.

2. Test items.

Test items	Symptom (diagnostic display on RC)	Check
Outdoor unit is installed properly on a solid base.	Fall, vibration, noise	
No refrigerant gas.	Incomplete cooling/heating function	
Refrigerant gas and liquid pipes and indoor drain hose extension are thermally insulated.	Water leakage	
Draining line is properly installed.	Water leakage	
Contact and check with the user whether the outdoor unit requires drainage work.	Drainage instillation from the bottom hole of the outdoor unit.	
System is properly ground to earth.	Electrical leakage	
The specified wires are used for interconnecting wire connections.	Inoperative or burn damage	
Outdoor unit's air intake or exhaust has clear path of air. Stop valves are opened.	Incomplete cooling/heating function	

2. System Configuration

After the installation and test operation of the room air conditioner have been completed, it should be operated and handled as described below. Every user would like to know the correct method of operation of the room air conditioner, to check if it is capable of cooling (or heating) well, and to know the most beneficial method of using it.

In order to meet this expectation of the users, giving sufficient explanations has been proven to reduce about 80% of the callback requests for servicing. However good the installation work is and however good the functions are, the customer may blame either the room air conditioner or its installation work because of improper operation. The installation work and handing over of the unit can only be considered to have been completed when its operation has been explained to the user without using technical terms but giving full knowledge of the equipment.

3. Instruction

3.1 Remote Controller

Name of Parts

Remote Controller: ARC447A3

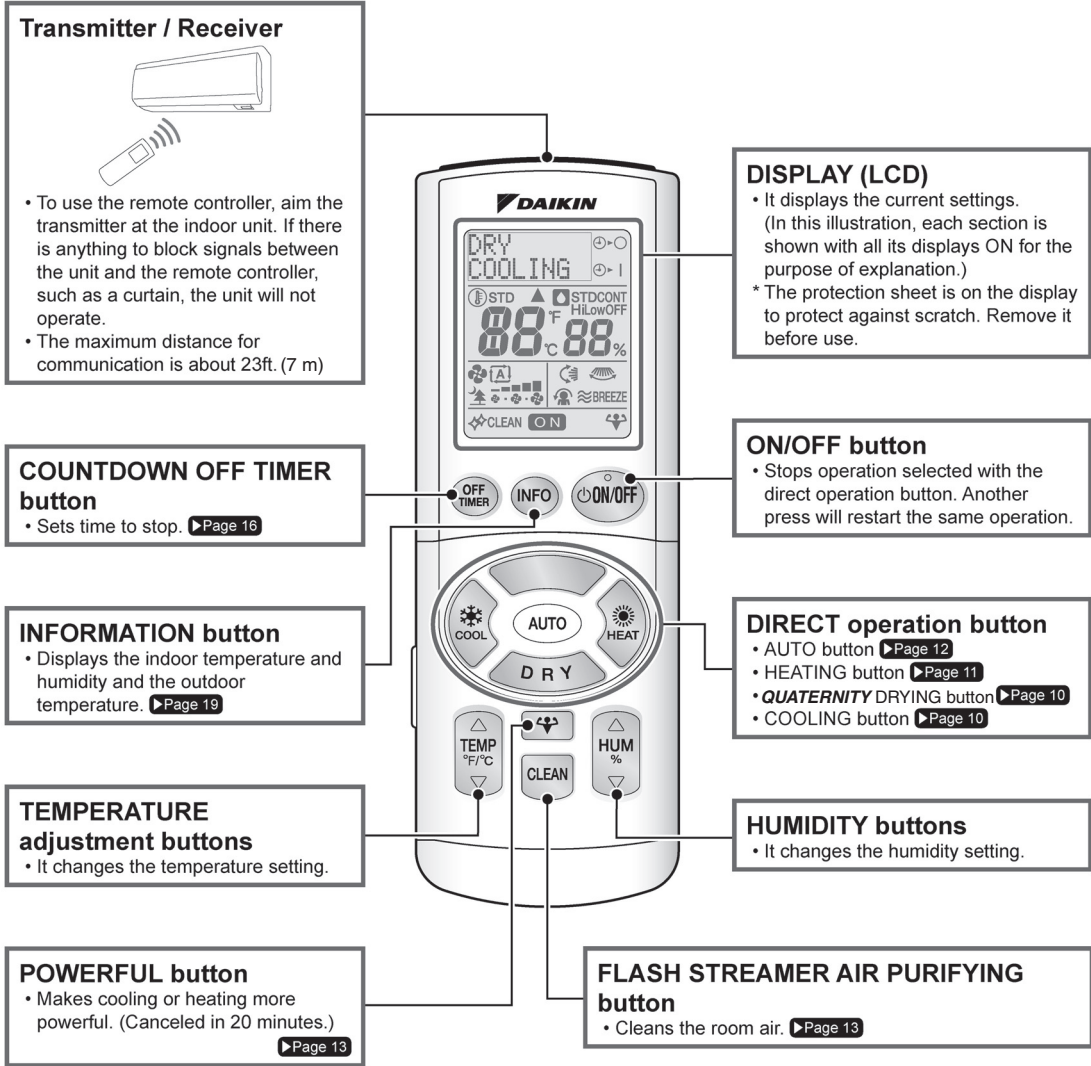

Open the lid

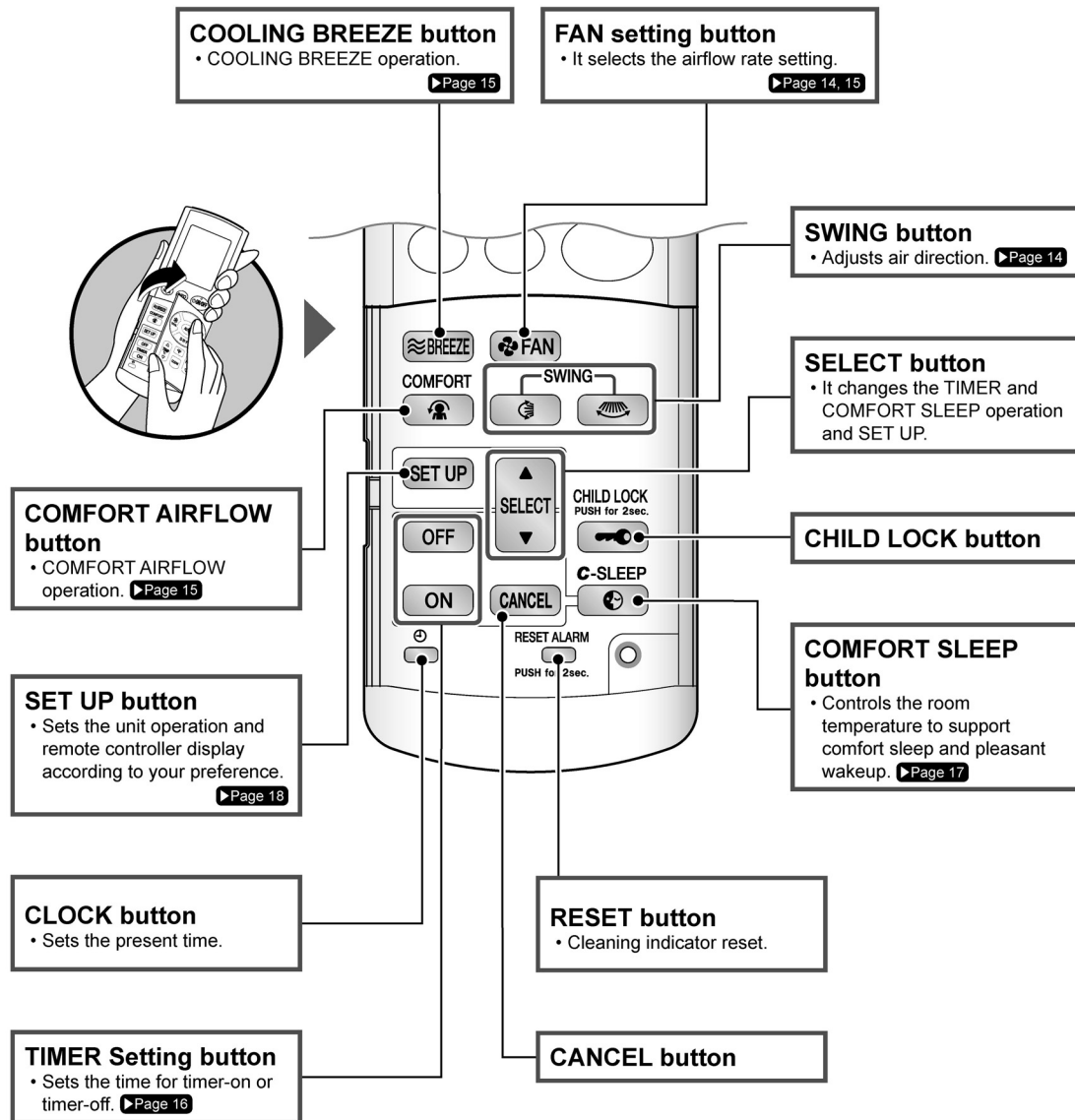

3.2 Cooling · QUATERNITY DRYING Operation

COOLING QUATERNITY DRYING Operation



COOLING operation

To lower temperature

Press  .

- The multi-monitor lamp of the unit will turn on GREEN.

To lower temperature and humidity

Press  .

- The multi-monitor lamp of the unit will turn on YELLOW.
- * It is recommended to switch to COOLING operation if you want to lower temperature preferentially during DRY COOLING operation.

QUATERNITY DRYING operation

To lower humidity

Press  .



- The multi-monitor lamp of the unit will turn on YELLOW.

■ To stop operation

Press  .

- The multi-monitor lamp of the unit will go off.

■ To change the temperature or humidity setting

	COOLING	DRY COOLING	DRY
	18°C - 32°C (64°F - 90°F)		-3°C (-5°F) - STD
	OFF ≥ HIGH ≥ STD ≥ LOW ≥ CONT		HIGH ≥ STD ≥ LOW ≥ CONT
	GREEN	YELLOW	

NOTE

- **Note on ON / OFF button**
 - Pressing  will start the same operation as the last time.
- **Note on COOLING operation**
 - This air conditioner cools the room by blowing the hot air in the room outside, so if the outside temperature is high, performance drops.
- **Note on DRY COOLING**
 - Pressing the humidity button down in COOLING mode set the unit to DRY COOLING.
 - Removes more humidity than the normal COOLING operation. It is recommended, however, to set temperature slightly lower than the room temperature to lower humidity because this operation mode does not heat air supplementary.
- **Note on QUATERNITY DRYING OPERATION**
 - Removes humidity with less lowering of the room temperature by heating air supplementary.
 - The operation mode change from COOLING to QUATERNITY DRYING may raise humidity temporarily.

3.3 Heating Operation

HEATING Operation



HEATING operation

To raise temperature

Press  .



- The multi-monitor lamp of the unit will turn on RED.

To stop operation

Press  .

- The multi-monitor lamp of the unit will go off.

To change the temperature

HEATING	
	10°C - 30°C (50°F - 86°F)
MULTI-MONITOR ON/OFF 	RED

NOTE

■ Note on HEATING operation

- Since this air conditioner heats the room by taking heat from outdoor air to indoors, the HEATING capacity becomes smaller in lower outdoor temperatures. If the HEATING effect is insufficient, it is recommended to use another HEATING appliance in combination with the air conditioner.
- The heat pump system heats the room by circulating hot air around all parts of the room. After the start of HEATING operation, it takes some time before the room gets warmer.
- In HEATING operation, frost may occur on the outdoor unit and lower the HEATING capacity. In that case, the system switches into defrosting operation to take away the frost.
- During defrosting operation, hot air does not flow out of indoor unit.

3.4 AUTO Operation

AUTO Operation

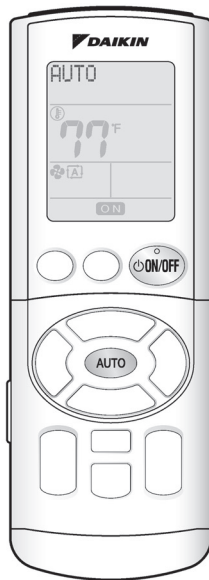

After pressing the AUTO button, the air conditioner will operate according to room conditions in an automatic mode.

Press **AUTO**.

- **HEATING:** The multi-monitor lamp of the unit will turn on **RED**.
- **COOLING:** The multi-monitor lamp of the unit will turn on **GREEN**.
- The color of the multi-monitor lamp changes according to the actual operations.
- When the AUTO button is pressed, the color according to the operation selected by the air conditioner will light up.

■ To change the temperature setting

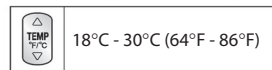

■ To stop operation

Press **ON/OFF**.

- The multi-monitor lamp of the unit will go off.

NOTE

■ Note on AUTO operation

- In AUTO operation, the system selects an appropriate operation mode (COOLING or HEATING) based on the room temperature at the start of the operation.
- The system automatically reselects setting at a regular interval to bring the room temperature to user setting level.
- If you do not like AUTO operation, you can manually select the operation mode and setting you like.

3.5 FLASH STREAMER AIR PURIFYING · POWERFUL Operation

FLASH STREAMER AIR PURIFYING · POWERFUL Operation

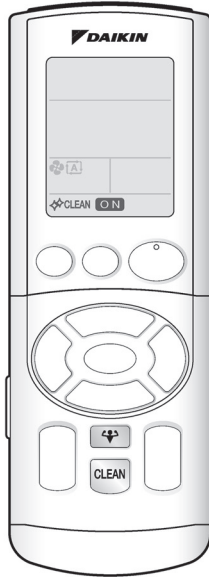

The absorption power of the Titanium apatite photocatalytic air-purifying filter and air supply filter and the resolving power of the streamer discharge reduce bad odors and viruses, cleaning the room air.

Press .

(Can be used together with heating or cooling, or on its own.)

- Changes every time the button is pressed. (Use instead of FAN operation.)



- The multi-monitor lamp of the unit will turn on **WHITE**.
(This will illuminate whitely for the first 2 seconds of operation of the air conditioner.)

ATTENTION

- Temperature and humidity cannot be changed during FLASH STREAMER AIR PURIFYING operation only.

POWERFUL operation quickly maximizes the cooling (heating) effect in any operation mode.

Press  during operation.

- POWERFUL operation ends in 20 minutes.

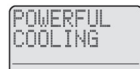

- POWERFUL COOLING: The multi-monitor lamp of the unit will turn on **GREEN**.

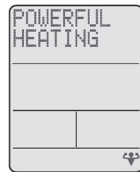

- POWERFUL HEATING: The multi-monitor lamp of the unit will turn on **RED**.

■ To cancel POWERFUL operation

Press  again.

- The operation mode goes back to the previous one. The multi-monitor lamp on the unit also goes back to the previous color.

NOTE



■ Note on FLASH STREAMER AIR PURIFYING operation

- The streamer discharge energy and Titanium apatite photocatalytic air-purifying filter clean the air in the room.

■ What is streamer discharge?

- It generates high-speed electron with high oxidizing power in the unit to resolve odor and harmful gas.
(It is safe because the high-speed electron is generated and goes away inside the unit.)
- * The streamer discharge fizzes, but this is not a malfunction.

■ Note on POWERFUL operation

- Can be used for COOLING, DRY COOLING and HEATING. (Cannot be used while the unit is not running.)
Pressing  during COOLING, DRY COOLING changes the operation mode to POWERFUL COOLING.
Pressing  during HEATING, change the operation mode to POWERFUL HEATING.
- The operation noise is slightly louder during POWERFUL operation.

3.6 Adjusting Airflow Direction · Airflow Rate

ADJUSTING AIRFLOW DIRECTION · AIRFLOW RATE

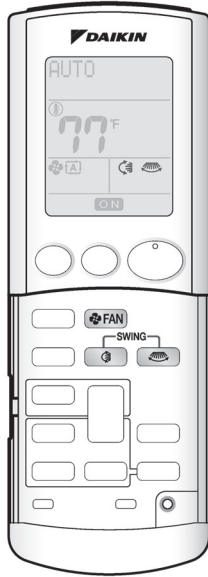

More comfortable airflow is provided with airflow direction and airflow rate adjustment.

- To change vertical and horizontal airflow directions
Press or during operation.



(In case of vertical direction) • The airflow direction indication will display.

- The horizontal and vertical louvers respectively move vertically and horizontally automatically.

- If you want to fix airflow direction
Press or again.

- To use 3-D AIRFLOW
Press and then during operation.

- The vertical and horizontal airflow direction indications will display.
- The horizontal and vertical louvers move alternately.

- To cancel 3-D AIRFLOW
Press or again.

- To change the airflow rate
Press during operation. (Refer to table.)

- COOLING or HEATING with “” or other weak airflow rate may not cool or heat the room sufficiently.
- Indoor unit quiet operation
When the air flow is set to “”, the noise from the indoor unit will become quieter.

Operating mode	Airflow rate setting
QUATERNITY DRYING	
DRY COOLING	
AUTO / COOLING	
HEATING	
FLASH STREAMER AIR PURIFYING	

Five levels of air flow rate setting from to plus “” “” are available.

NOTE

- If the unit is operated with the horizontal louvers pointed down and stopped in COOLING, QUATERNITY DRYING, or DRY COOLING operation, the louvers will move automatically after about one hour. (This it to prevent condensation from forming on them.)

■ ATTENTION

- Be sure to use the remote controller to adjust the airflow direction. Manual operation of the louvers may cause it to work improperly.

■ Note on Adjusting the vertical airflow direction

- The movable area for the horizontal louver is different depending on the operation mode.

■ Note on 3-D AIRFLOW

- Using 3-D AIRFLOW circulates cold air, which tends to be collected at the bottom of the room, and hot air, which tends to be collected near the ceiling, throughout the room, preventing areas of cold and hot from developing.

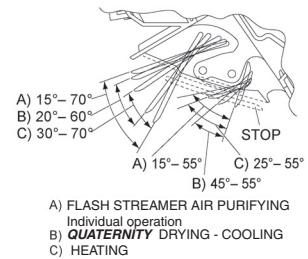

3.7 COMFORT AIRFLOW · COOLING BREEZE Operation

COMFORT AIRFLOW · COOLING BREEZE Operation



■ COMFORT AIRFLOW operation

Press .

■ COMFORT AIRFLOW MODE operation

- The airflow direction and airflow rate are adjusted so that the air from the unit does not blow directly on the occupants of the room.
- < COOLING/DRYING > The flap will go up.
- < HEATING > The flap will go down.
- The airflow rate is set to "AUTO".

■ COOLING BREEZE operation

Press .







■ COOLING BREEZE operation

- COOLING BREEZE operation is for COOLING, **QUATERNITY** DRYING and FLASH STREAMER AIR PURIFYING operation.

■ To change the airflow rate

Press  during operation. (Refer to table.)

- COOLING or HEATING with "▲" or other weak airflow rate may not cool or heat the room sufficiently.
- Indoor unit quiet operation
When the air flow is set to "▲", the noise from the indoor unit will become quieter.

Operating mode	Airflow rate setting		
QUATERNITY DRYING		●	●
DRY COOLING		●	●
AUTO / COOLING		●	●
HEATING		●	
FLASH STREAMER AIR PURIFYING			●

 : COMFORT AIRFLOW MODE operation is possible.

 : COOLING BREEZE operation is possible.

Five levels of air flow rate setting from "●" to "▲" plus "[A]" "▲" are available.

NOTE

■ Note on COMFORT AIRFLOW MODE operation

- The airflow direction is as figure.

■ Note on COOLING BREEZE operation

- The vertical movement of the horizontal louvers with "1/ f breeze" rhythm provides comfort air like natural breeze. The room temperature is felt cooler with cooling breeze.

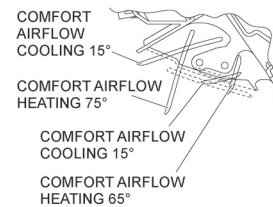

3.8 TIMER Operation

TIMER Operation



Timer functions are useful for automatically switching the air conditioner on or off at night or in the morning. The timer operates only one time. Set the timer for each use.

■ COUNTDOWN OFF TIMER operation

Set the time to stop.

Press **OFF TIMER**.

- The displayed time, which changes in 0.5 hour increments every time the button is pressed, is set. The time from 0.5 to 9.5 hours can be set.
- TIMER lamp will light up.

■ ON/OFF TIMER operation

Set time for ON TIMER or OFF TIMER.

- Check that the clock is correct. If not, set the clock to the present time.
- The present time display disappears when the time ON/OFF TIMER is reserved.

1. Press OFF for OFF TIMER and press ON for ON TIMER.



2. Press SELECT to set the time to be reserved.

- Pressing the button changes the time in 10 minutes. Holding the button makes the time change faster.

3. Press OFF for OFF TIMER and press ON for ON TIMER.



■ To cancel the TIMER operation

Press **CANCEL**.

- The TIMER lamp will go off and the TIMER will be canceled.

NOTE

■ In the following cases, set the timer again.

- After a breaker has turned OFF.
- After a power failure.
- After replacing batteries in the remote controller.

■ Note on TIMER operation

- Starting COUNTDOWN OFF TIMER and OFF TIMER causes the unit to automatically change the set temperature 1 hour later to prevent the room from becoming too cold or too hot. (Turns up 0.5°C (1°F) during COOLING or DRY COOLING and turns down 2°C (3.6°F) during heating.
- Reserving the ON TIMER will cause the unit to start running up to 1 hour before, in order to make sure the temperature reaches the temperature set on the remote controller by the set time.
- When operating the unit via the COUNTDOWN OFF TIMER or OFF TIMER, the actual length of operation may vary from the time entered by the user.
- Once you set ON/OFF TIMER, the time setting is kept in the memory. However, the COUNTDOWN OFF TIMER does not have this memory function. (The memory is canceled when remote controller batteries are replaced.)
- Cannot operate with POWERFUL or COMFORT SLEEP operation.

■ To combine ON TIMER and OFF TIMER

- See the right example for reserving in combination of COUNTDOWN OFF TIMER and ON TIMER as well as OFF TIMER and ON TIMER.

■ To cancel combined reservation

- Press **ON** and then **CANCEL** to cancel the ON TIMER only.
- Press **OFF** and then **CANCEL** to cancel the OFF TIMER only.
- Press **OFF TIMER** several times to reach 9.5 hours and then press it one more time to cancel the COUNTDOWN OFF TIMER only.

(Example)

Present time: 23:00 (air conditioner is running).
You want to have the unit run for 1 more hour and then turn back on at 7:00 am.

Setting the COUNTDOWN OFF TIMER to 0:00 1 hour later
Setting the ON TIMER to 0:00 at 7:00

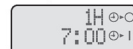

Setting the OFF TIMER to 0:00 at 0:00
Setting the ON TIMER to 0:00 at 14:00

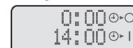

3.9 COMFORT SLEEP Operation

COMFORT SLEEP Operation

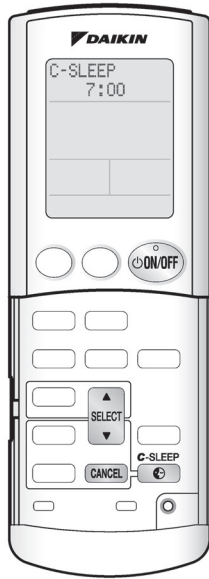

Controlling the room temperature supports comfort sleep and pleasant wake up.

- Check that the clock is correct. If not, set the clock to the present time.
- The present time display disappears when the COMFORT SLEEP operation is set.

1. Press during operation.





2. Press to set the time to wake up.

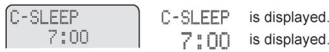

- Pressing the button changes the time in 10 minutes. Holding the button makes the time change faster.

3. Press .



- When settings are made while the unit is not running, press  to start the operation.

■ To cancel the comfort sleep operation

Press .

ATTENTION

- Make the room temperature comfortable to some extent before sleep.
 <Recommended set temperature> COOLING 26 - 29°C (79 - 84°F)
 HEATING 20 - 25°C (68 - 77°F)
- * Too low set temperature may cause you to get chilled while asleep.

NOTE

- **Note on COMFORT SLEEP operation**
 - Can be used for COOLING, DRY COOLING and HEATING.
 - Cannot be used with TIMER operation.
- **How to use COMFORT SLEEP operation effectively**
 - Starting COMFORT SLEEP operation lowers the set temperature by 2°C (3.6°F) in 3 hours and starts raising it by 1°C (1.8°F) 1 hour before the set time, offering V-curve temperature control. (See the right figure.)
 - Set the airflow direction so that the air from the unit does not directly blow on the occupants of the room.

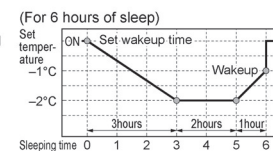

3.10 SET UP · CHILD PROOF LOCK

SET UP · CHILD PROOF LOCK

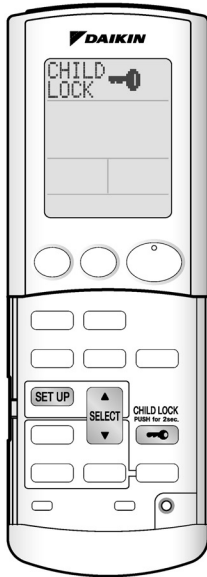

■ SET UP

Sets the unit operation and remote controller display according to your preference.

1. Press **SET UP** .

• The setup mode will be activated.

2. The item will change every time **SET UP** is pressed.

3. The settings will change every time **SELECT** is pressed respectively.

• Direct the remote controller toward the main unit to make settings.

is default.

Item	Setting	Description
CELSIUS/FAHRENHEIT change	<input type="checkbox"/> °F <input type="checkbox"/> °C	• Switches the temperature between Celsius and Fahrenheit.
MONITOR BRIGHTNESS	HIGH <input type="checkbox"/> LOW <input type="checkbox"/> OFF	• Changes the brightness of the indoor unit display.
BEEP volume	LOW <input type="checkbox"/> HIGH <input type="checkbox"/> OFF	• Sets the receiving tone volume.
CONTRAST setting	1 <input type="checkbox"/> 6 <input type="checkbox"/> 16	• Sets the grayscale for the remote controller LCD. • Selectable from contrast 1 to 16.

Setting complete : The display on the remote control goes back to normal if no setting is made for 10 seconds.

■ CHILD PROOF LOCK

Restrict the remote controller operates to avoid misuse by children.

Press **CHILD LOCK** for about 2 seconds.

• “CHILD LOCK ” is displayed.

■ To cancel CHILD PROOF LOCK

Press **CHILD LOCK** for about 2 seconds again.

3.11 INFORMATION DISPLAY

INFORMATION DISPLAY



Displays the room temperature and humidity and outdoor temperature.

Press **INFO**.

- After pressing **INFO**, point the remote controller at the air conditioner unit for 2 seconds.

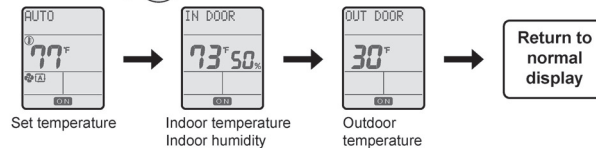

- The display changes every time **INFO** is pressed.

NOTE

■ Note on INFORMATION DISPLAY

- The signal from the air conditioner is not being received properly if "RCU ERR. RETRY" is displayed when you press **INFO**. Repeat, aiming the remote controller at the air conditioner.
- During operation, the outdoor temperature may sometimes be displayed higher than it actually is in COOLING or **QUATERNITY DRYING** mode or lower in HEATING mode (especially if frost has accumulated on the outdoor unit), due to the effects of the air blown from the outdoor unit or the temperature of the heat exchanger.
- The lowest indoor and outdoor temperature which can be displayed is -9°C (16°F). This will be displayed even if the actual temperature is lower. The highest temperature is 37°C (99°F). This will be displayed even if the actual temperature is higher.
- The indoor and outdoor temperatures and the humidity which are displayed are those near the sensors attached to the main air conditioner unit.
- The displayed temperature and humidity should only be taken as approximations, as they may be affected if there are objects around the sensors or due to direct sunlight, depending on where the air conditioner is installed.

Part 6

Service Diagnosis

1. Convenient Service Check Function	85
2. Troubleshooting	87
2.1 Error Code Indication by Remote Controller	87
2.2 Air conditioner does not run.	88
2.3 Air conditioner runs but does not cool or heat.	91
2.4 When operation starts, safety breaker trips.....	93
2.5 Air conditioner makes a loud sound and vibrates.....	95
2.6 Indoor Unit PCB Abnormality	96
2.7 Peak-cut Control or Freeze-up Protection	97
2.8 Fan Motor System (DC Motor) Abnormality	99
2.9 Streamer Unit Abnormality	101
2.10 Thermistor System Abnormality	103
2.11 Front Panel Open / Close Abnormality	104
2.12 Humidity Sensor Abnormality	105
2.13 Signal Transmission Error (Indoor Unit - Outdoor Unit)	106
2.14 Incompatible Power Supply between Indoor Unit and Outdoor Unit	108
2.15 Outdoor Unit PCB Abnormality.....	109
2.16 OL Activation (Compressor Overload)	110
2.17 Compressor Lock	111
2.18 DC Fan Lock	112
2.19 Input Overcurrent Detection	113
2.20 Four-Way Valve Abnormality.....	115
2.21 Discharge Pipe Temperature Control.....	117
2.22 High Pressure Control in Cooling	118
2.23 Compressor Sensor System Abnormality	120
2.24 Position Sensor Abnormality	121
2.25 DC Voltage / DC Current Sensor Abnormality	123
2.26 Thermistor System Abnormality	124
2.27 Abnormal Temperature in Electrical Box.....	126
2.28 Temperature Rise in Radiation Fin.....	128
2.29 Output Overcurrent.....	130
2.30 Insufficient Gas.....	132
2.31 Over Voltage Protection / Low Voltage Protection	134
2.32 Outdoor Unit PCB Abnormality or Communication Circuit Abnormality	135
2.33 Signal Transmission Error on Outdoor Unit PCB	138
2.34 Lights-out of Microcomputer Status Lamp.....	140
3. Check.....	141
3.1 Thermistor Resistance Check	141
3.2 Installation Condition Check.....	142
3.3 Outdoor Fan System Check (DC Motor)	142

3.4	Power Supply Waveform Check.....	143
3.5	Main Circuit Electrolytic Capacitor Check	143
3.6	Refrigerant System Check	144
3.7	“Inverter Checker” Check	145
3.8	Power Transistor Check.....	146
3.9	Discharge Pressure Check.....	147
3.10	Electronic Expansion Valve Check.....	148
3.11	Indoor Unit PCB Output Check	149
3.12	Rotating Pulse Input on Outdoor Unit PCB Check	150
3.13	Humidity Sensor Check.....	151
3.14	Main Circuit Short Check.....	151
3.15	Four-Way Valve Performance Check.....	152
3.16	Solenoid Valve for Dehumidification Check	153

1. Convenient Service Check Function

■ Failure diagnosis with operation lamp

The operation lamp on the display of the indoor unit flashes when any of the following failures are detected.

1. When a protection device of the indoor or outdoor unit is activated or when the thermistor malfunctions and the system does not work.
2. When a signal transmission error occurs between the indoor and outdoor units.

For detailed troubleshooting, refer to the following pages **Troubleshooting** (87~).

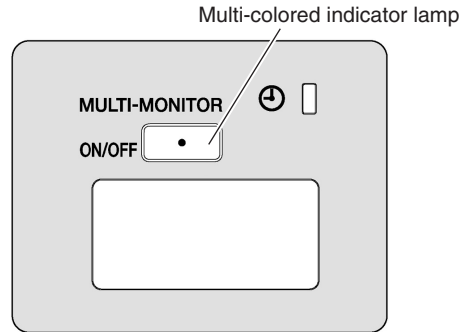

(R10104)

■ Failure diagnosis by remote controller

With the wireless remote controller supplied with the unit, or sold separately, error codes by failure diagnosis can be confirmed. (Press timer cancel button down for 5 seconds continuously.)

ARC447A series

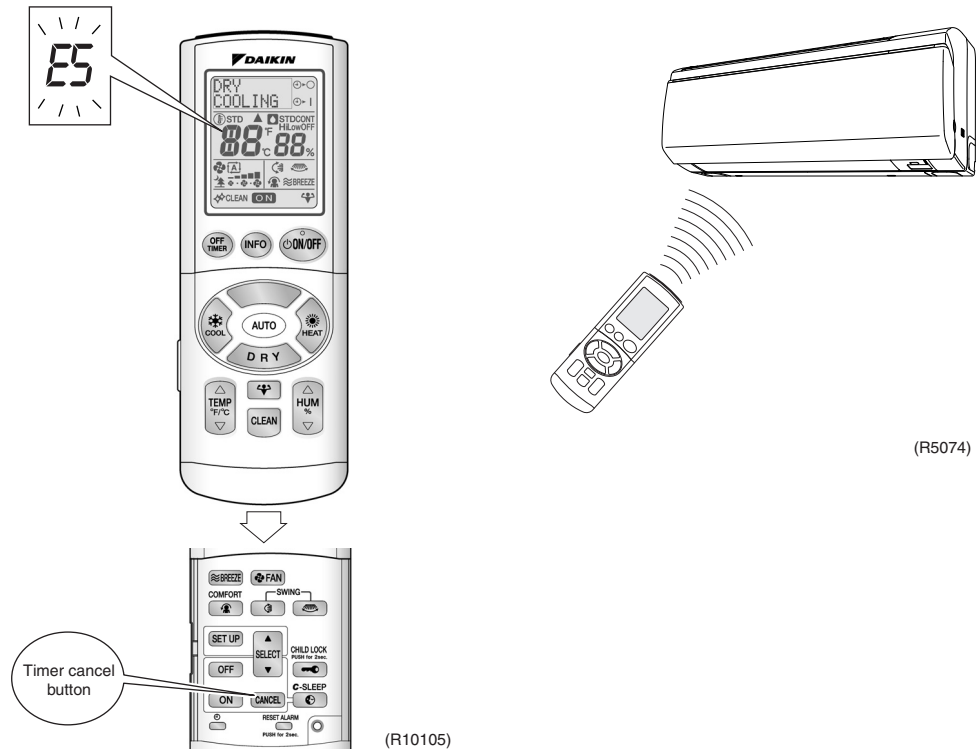

(R5074)

(R10105)

1. Hold the timer cancel button down for 5 seconds, with the remote controller set toward the indoor unit.
2. The temperature display on the remote controller changes to the error code display and a long beep notifies this indication change.

<Note>

To cancel indication of error code, hold the timer cancel button down for 5 seconds. The code display also cancels itself if the button is not pressed for 1 minute.

■ Failure diagnosis by LED indication

The following failure diagnosis can be done by LED indication on the outdoor unit PCB.

1. The outdoor unit has 2 green LED(LED A, LED5) on the PCB. Refer to page 11.

The flashing green LED indicates "in order" condition.

The turned ON or OFF LED indicates the failure related to the microcomputer.

- PCB is set upside down (with backside up).
- LED A can be visually inspected through an inspection slit.

2. Troubleshooting

2.1 Error Code Indication by Remote Controller

* Various cases may be possible.

Code	Unit	Description	Reference page
Basic Failure Diagnosis		Air conditioner does not run.	88
		Air conditioner runs but does not get cooling (heating).	91
		When operation starts, safety breaker trips.	93
		Air conditioner makes a loud noise and vibrates.	95
<i>R1</i>	Indoor	Indoor unit PCB abnormality	96
<i>RS</i>		Peak-cut control or freeze-up protection	97
<i>RE</i>		Fan motor system abnormality	99
<i>RM</i>		Streamer unit abnormality	101
<i>C4</i>		Indoor heat exchanger thermistor abnormality	103
<i>C7</i>		Front panel open / close abnormality	104
<i>C9</i>		Room temperature thermistor abnormality	103
<i>CC</i>		Humidity sensor abnormality	105
<i>E1</i>	Outdoor	Outdoor unit PCB abnormality	109
<i>ES</i>		OL activation (compressor overload)	110
<i>EE</i>		Compressor lock	111
<i>E7</i>		DC fan lock	112
<i>EB</i>		Input overcurrent detection	113
<i>ER</i>		Four-way valve abnormality	115
<i>F3</i>		Discharge pipe temperature control	117
<i>FB</i>		High pressure control in cooling	118
<i>HO</i>		Compressor sensor system abnormality	120
<i>HE</i>		Outdoor	Position sensor abnormality
<i>HB</i>	DC voltage / DC current sensor abnormality		123
<i>HS</i>	Outdoor air thermistor abnormality		124
<i>J3</i>	Discharge pipe thermistor abnormality		124
<i>JE</i>	Outdoor heat exchanger thermistor abnormality		124
<i>L3</i>	Abnormal temperature in electrical box		126
<i>L4</i>	Temperature rise in radiation fin		128
<i>L5</i>	Output overcurrent		130
<i>P4</i>	Radiation fin thermistor abnormality		124
<i>U0</i>	System		Insufficient gas
<i>U2</i>		Over voltage protection (OVP) / low voltage protection (LVP)	134
<i>U4</i>		Signal transmission error (indoor unit - outdoor unit)	106
<i>U7</i>	Outdoor	Outdoor unit PCB abnormality or communication circuit abnormality	135
<i>U7</i>	System	Signal transmission error on outdoor unit PCB	138
<i>UR</i>		Incompatible power supply between indoor unit and outdoor unit	108
—	System	Lights-out of microcomputer status lamp	140

2.2 Air conditioner does not run.

**Method of
Malfunction
Detection**

**Malfunction
Decision
Conditions**

**Supposed
Causes**

- Power supply is OFF
- Improper power supply voltage
- Improper connection of wire
- Incorrect combination of indoor unit and outdoor unit
- Battery shortage of remote controller
- Invalid address setting
- Protection device works
(dirty air filter, insufficient charge of refrigerant, overcharge of refrigerant, mixed air, etc.)
- Transmission error between indoor unit and outdoor unit
(Defective PCB on outdoor unit)

Troubleshooting



Caution

Be sure to turn off the power switch before connecting or disconnecting the connector, or parts damage may occur.

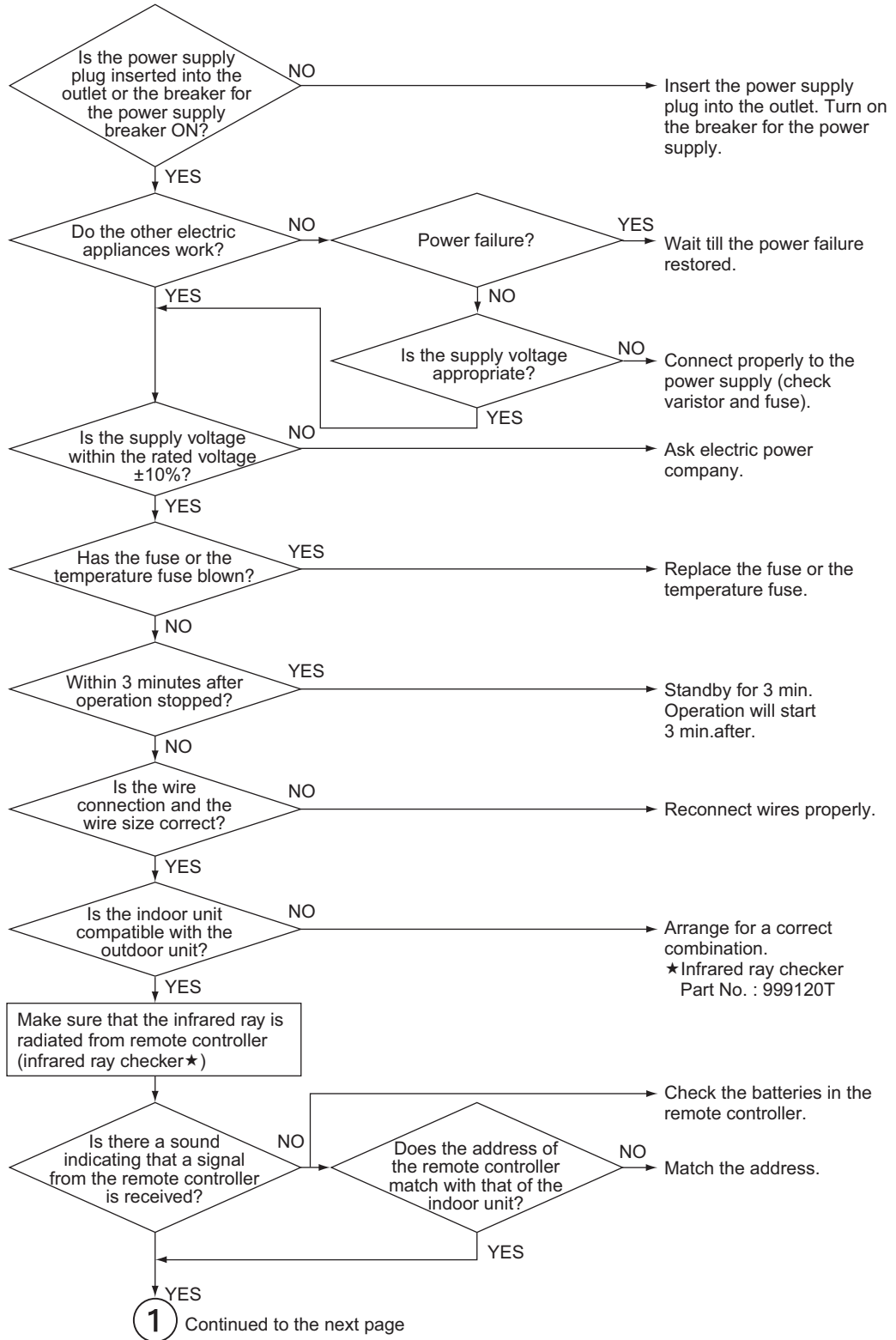

1 Continued to the next page

(R10106)

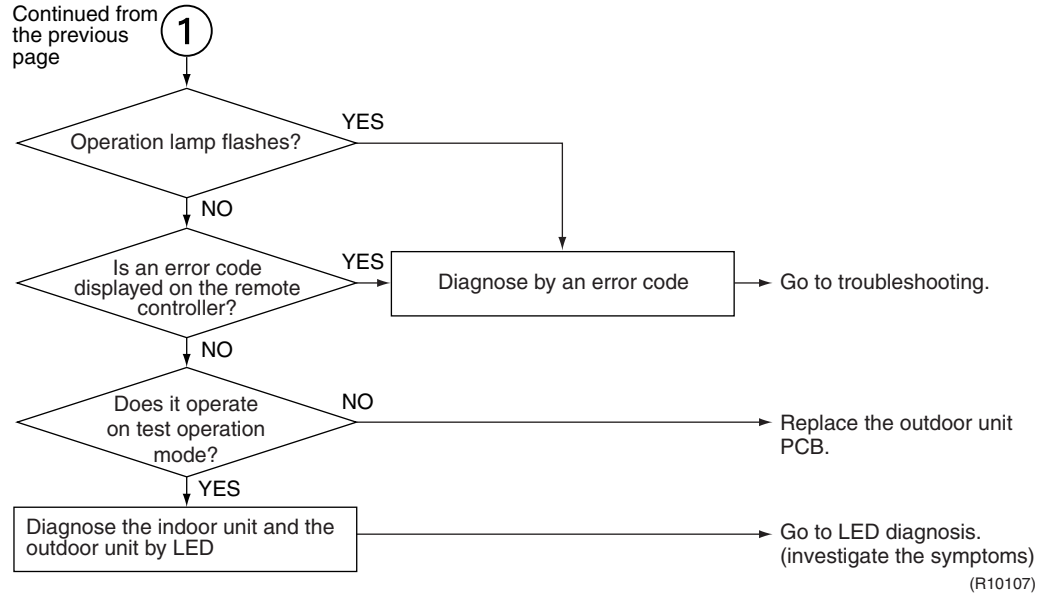

2.3 Air conditioner runs but does not cool or heat

**Method of
Malfunction
Detection**

**Malfunction
Decision
Conditions**

**Supposed
Causes**

- Incorrect temperature setting
- Incorrect combination of indoor unit and outdoor unit
- Blocked air filter
- Insufficient power
- Refrigerant piping is too long
- Improper setting of piping length
- Defective field piping (squeezed, etc.)

Troubleshooting



Check No.02
Refer to P.141



Caution Be sure to turn off the power switch before connecting or disconnecting the connector, or parts damage may occur.

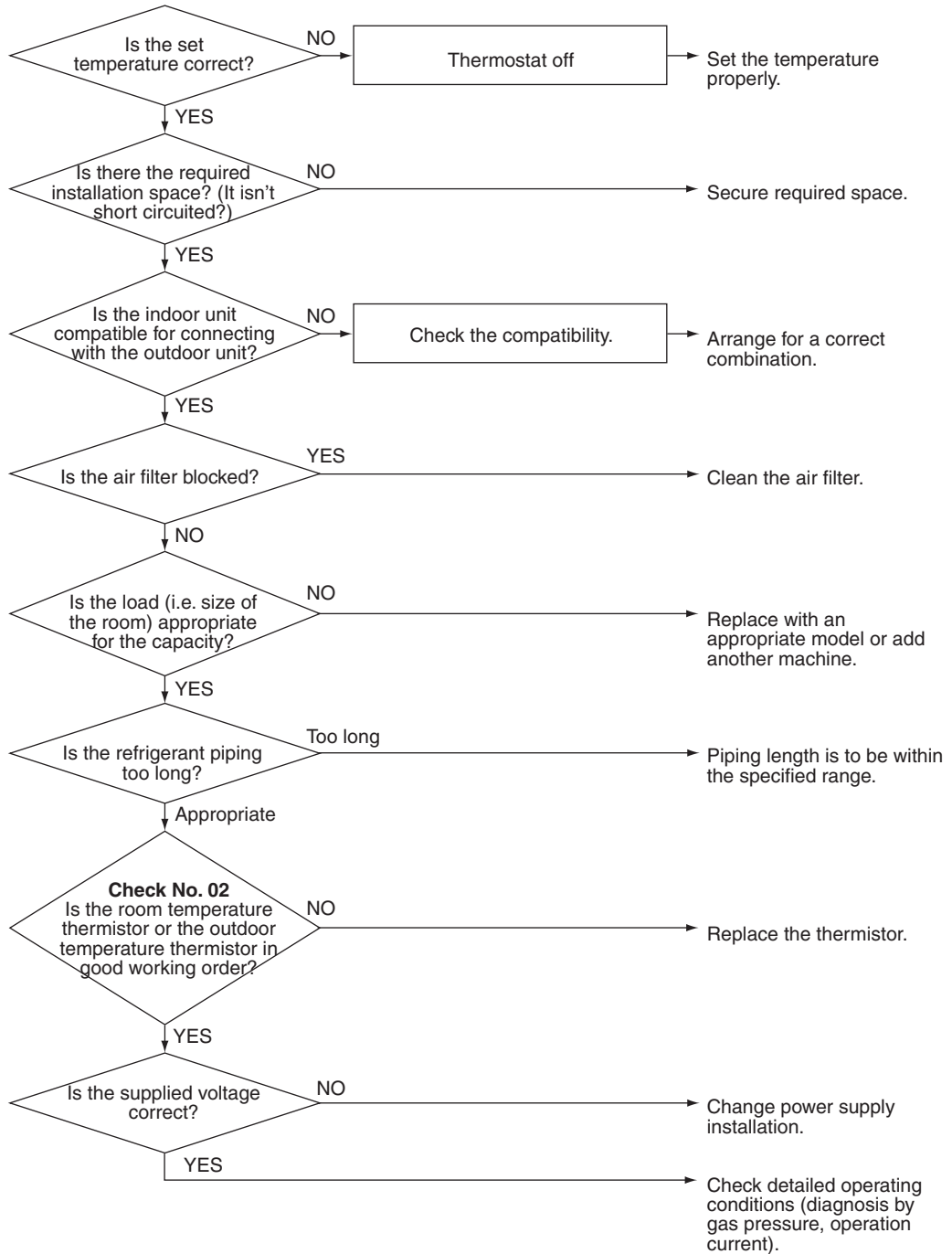

(R10108)



Warning:

When an air conditioner does not cool or heat the room, refrigerant leak is considered to be one of the reasons.

Make sure that there is no gas leakage or breaks due to an over-tightened flare connection.

Though the refrigerant used in an air conditioner is itself harmless, it can generate toxic gases when it leaks into a room and contacts flames, such as fan and other heaters, stoves, and ranges.

In case of leakage, ventilate the room immediately.

2.4 When operation starts, safety breaker trips

**Method of
Malfunction
Detection**

**Malfunction
Decision
Conditions**

**Supposed
Causes**

- Insufficient capacity of safety breaker
- Ground leakage breaker is too sensitive
- Not exclusive circuit
- The supply voltage is not within rated voltage $\pm 10\%$.
- The size of connecting wire is too small (indoor power supply unit)
- Air is mixed with refrigerant (over filling)
- Damaged outdoor unit PCB (short circuit)

Troubleshooting



Check No.29
Refer to P.151



Caution

Be sure to turn off the power switch before connecting or disconnecting the connector, or parts damage may occur.

[Power supply]

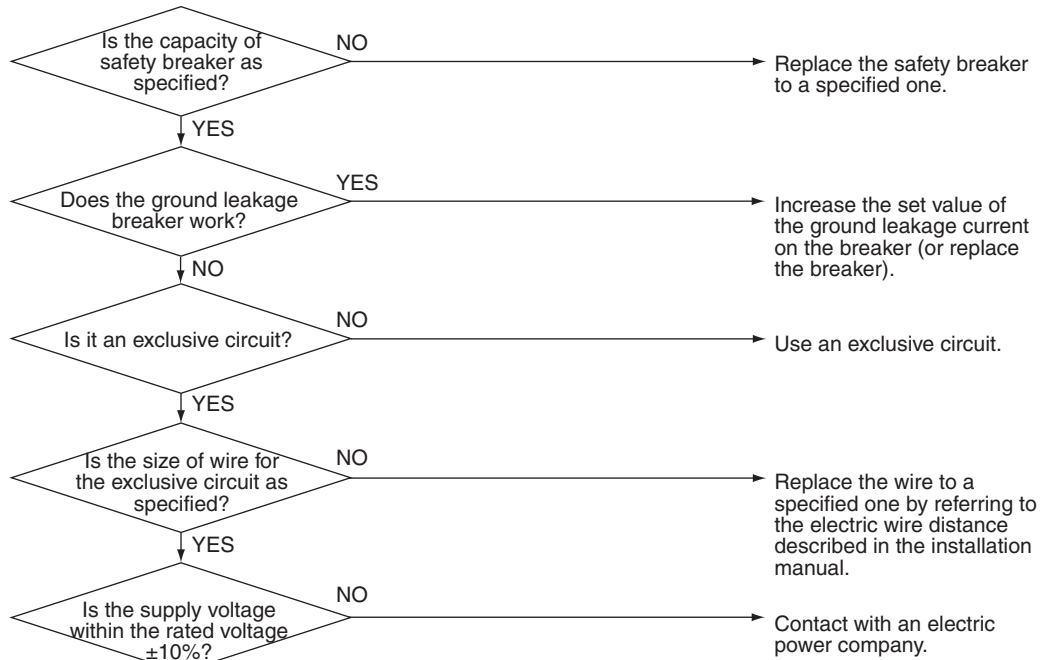

[Installation]

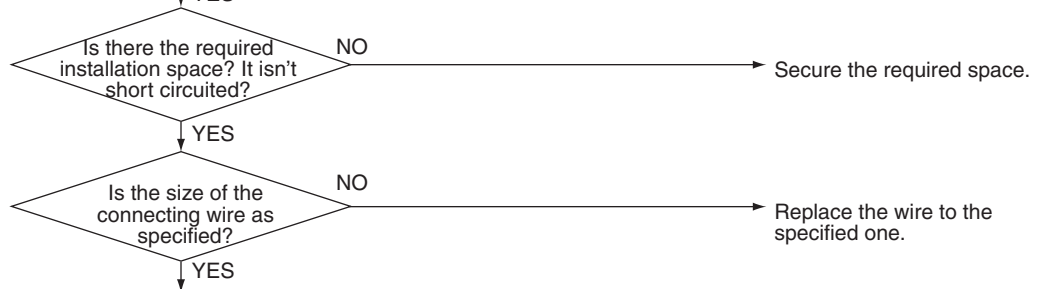

Check No. 29
Short circuit check

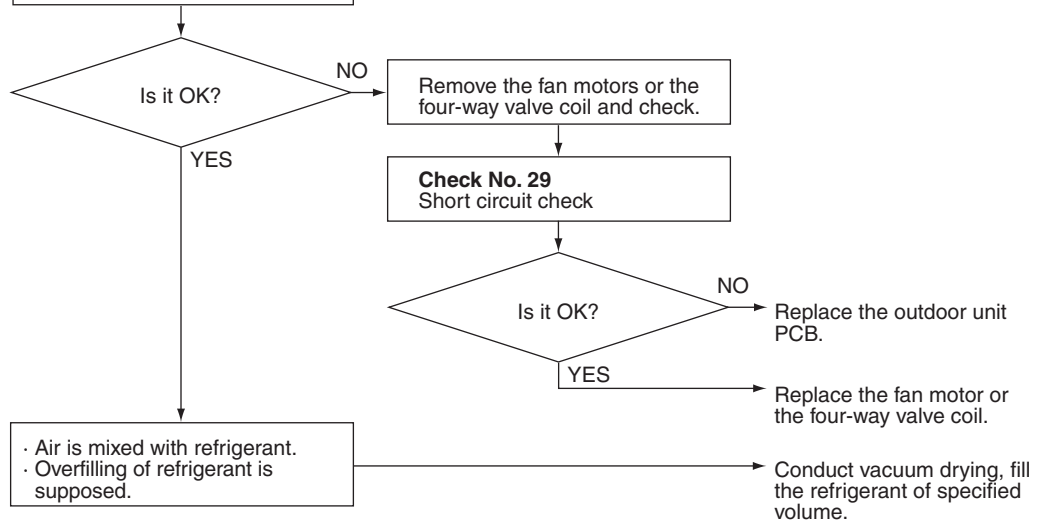

(R10109)

2.5 Air conditioner makes a loud sound and vibrates.

Method of Malfunction Detection

Malfunction Decision Conditions

Supposed Causes

- Piping length is too short
- Mounting wall is too thin
- Insufficient vibration prevention measures
- Deformation of the unit
- Improper quantity of refrigerant

Troubleshooting



Caution

Be sure to turn off the power switch before connecting or disconnecting the connector, or parts damage may occur.

[Installation]

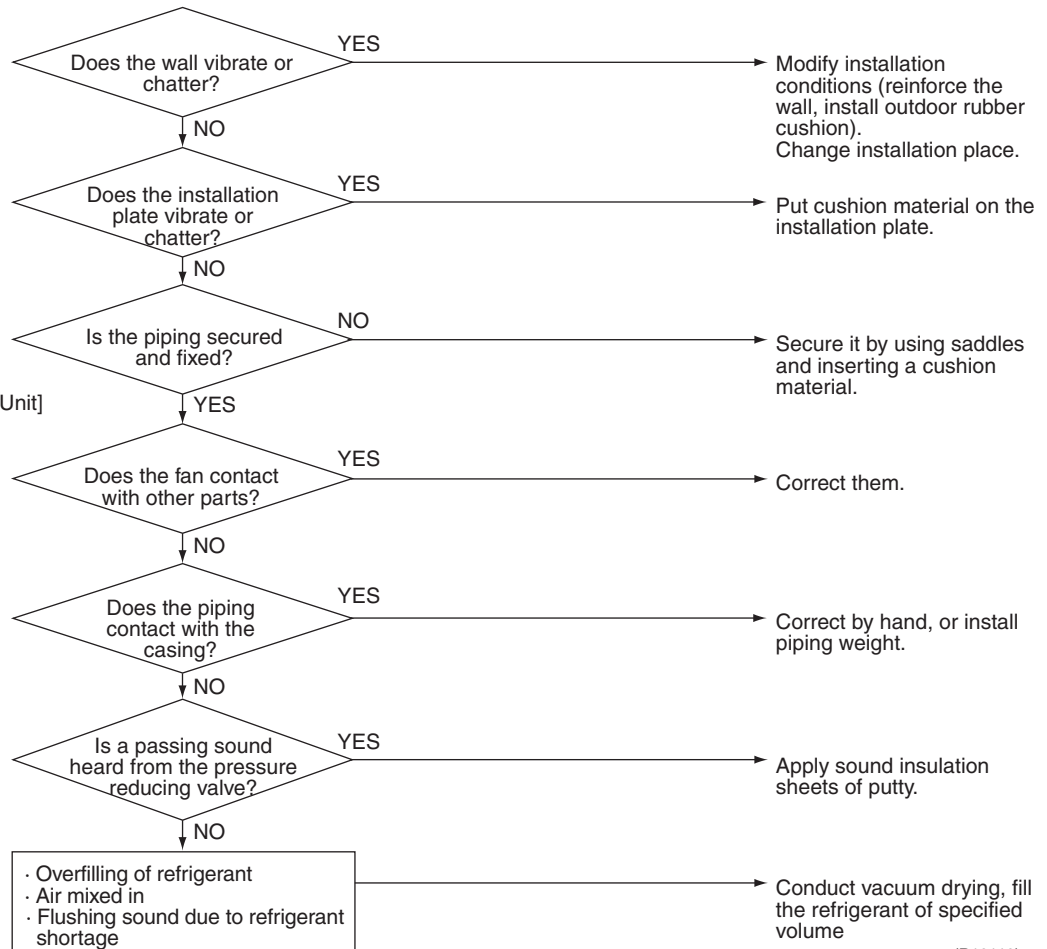

(R10110)

2.6 Indoor Unit PCB Abnormality

Remote Controller Display	
Method of Malfunction Detection	Check zero-cross detection from the power supply of the indoor unit
Malfunction Decision Conditions	When no zero-cross detection is performed in approximately 10 continuous seconds
Supposed Causes	<ul style="list-style-type: none"> ■ Defective indoor unit PCB (Faulty EEPROM data) ■ Improper connector connection ■ Defective indoor terminal board

Troubleshooting

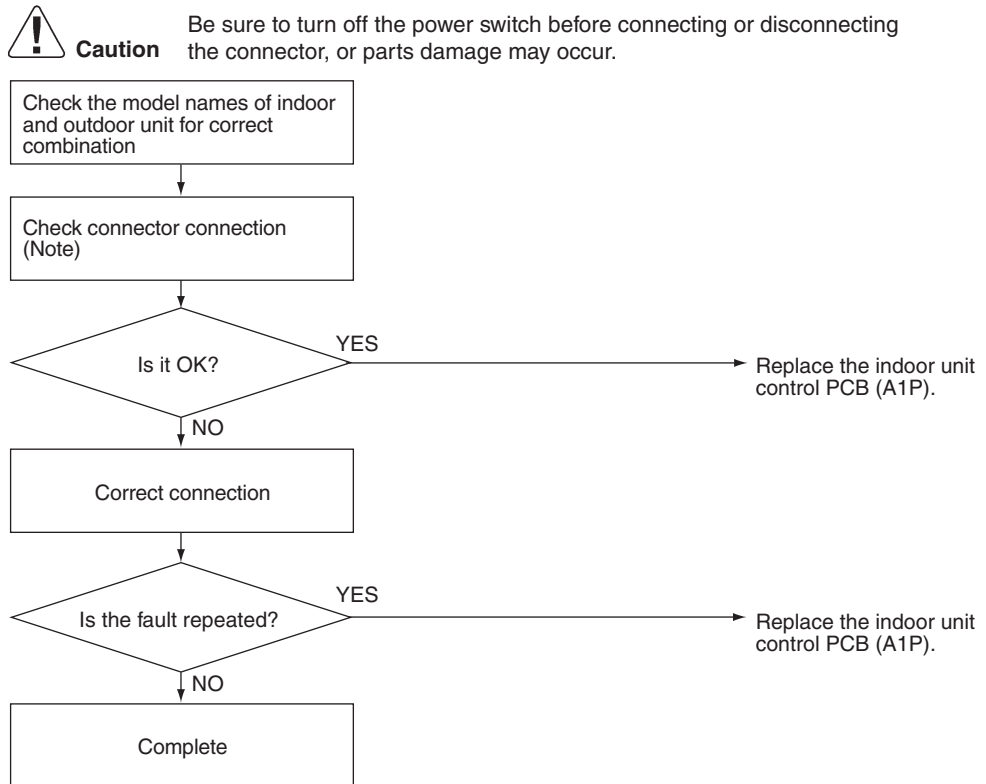

(R10111)

 **Note:** ■ Between terminal board and indoor unit control PCB.

2.7 Peak-cut Control or Freeze-up Protection

Remote Controller Display

85

Method of Malfunction Detection

- Peak-cut control (high pressure control)
During heating operation, the temperature detected by the indoor heat exchanger thermistor is used for the high pressure control (stop, outdoor fan stop, etc.).
- Freeze-up protection control (operation halt) is activated during cooling operation according to the temperature detected by the indoor heat exchanger thermistor.

Malfunction Decision Conditions

- Peak-cut control
On heating operation, when indoor heat exchanger temperature is about 47°C(116.6°F) or more
- Freeze-up protection
On cooling operation, indoor heat exchanger temperature is 0°C(32°F) or less

Supposed Causes

- System shutdown due to dirty indoor unit filter
- System shutdown due to dirty indoor heat exchanger
- System shutdown due to short circuit
- Faulty detection due to defective indoor heat exchanger thermistor
- Reheating dehumidification solenoid valve remains closed (on cooling operation)
- Faulty detection due to defective indoor unit PCB

Troubleshooting



Check No.02
Refer to P.141



Caution

Be sure to turn off the power switch before connecting or disconnecting the connector, or parts damage may occur.

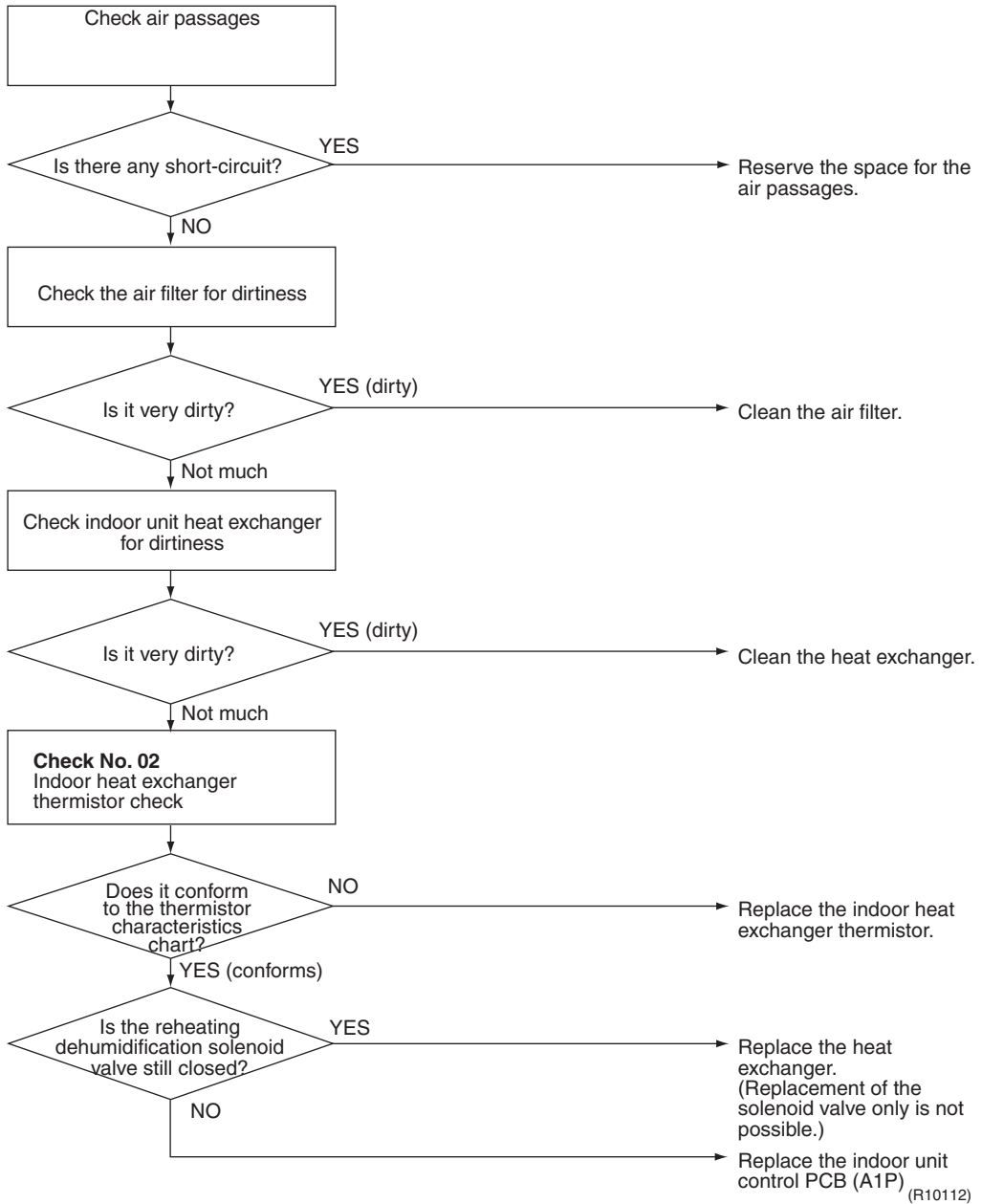

2.8 Fan Motor System (DC Motor) Abnormality

Remote
Controller Display

FE

**Method of
Malfunction
Detection**

The fan speed detected by the Hall IC during operation of high-pressure fan motor is used to determine abnormal fan operation.

**Malfunction
Decision
Conditions**

When the detected fan speed is less than 50% of the HH tap under the maximum fan motor rpm demanded.

**Supposed
Causes**

- System shutdown due to rare short circuit inside the fan motor
- System shutdown due to breakage of wire inside the fan motor
- System shutdown due to breakage of the lead wire of fan motor
- Faulty detection due to defective indoor control PCB

Troubleshooting



Check No.18
Refer to P.149



Caution Be sure to turn off the power switch before connecting or disconnecting the connector, or parts damage may occur.

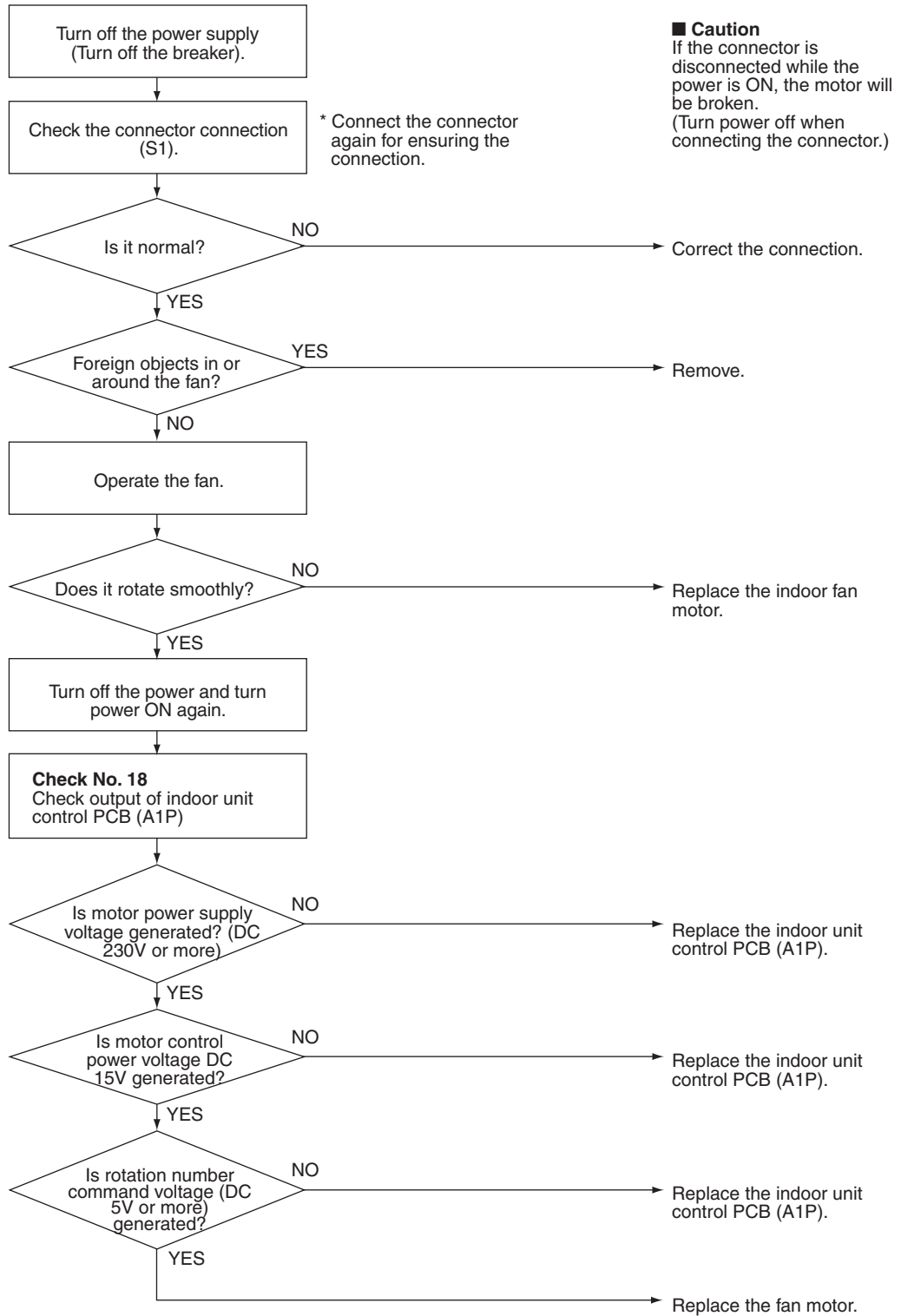

Caution
If the connector is disconnected while the power is ON, the motor will be broken. (Turn power off when connecting the connector.)

* Connect the connector again for ensuring the connection.

(R10113)

2.9 Streamer Unit Abnormality

Remote
Controller
Display



Method of
Malfunction
Detection

Malfunction
Decision
Conditions

- If the error repeats 3 times in air purifying operation.
- Clearing condition: Continuous run for about 2 minutes (normal).

Supposed
Causes

- Short circuit caused by the dust or water on the streamer unit electrode part.
- Scratch or crack in the harness for the streamer unit.
- Faulty streamer unit PCB

Troubleshooting



Caution Be sure to turn off the power switch before connecting or disconnecting the connector, or parts damage may occur.

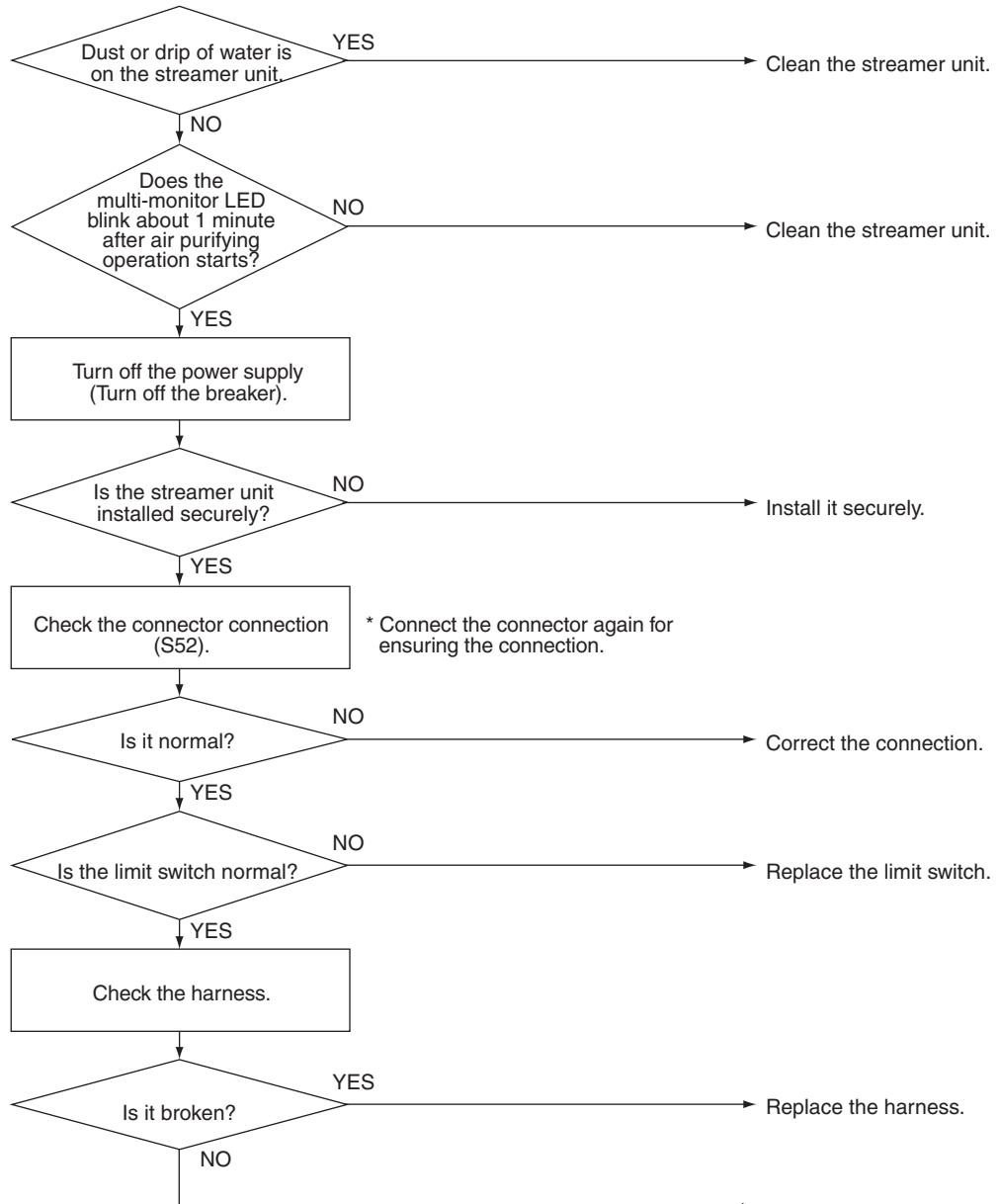

Note 1.
Be careful not to break the electrode in cleaning.

Note 2.
The electrode part contains high voltage so be sure to disconnect the power plug or turn of the breaker when you clean it. Touching it while it is connected results in electrical shock.

(R10114)

2.10 Thermistor System Abnormality

Remote Controller Display	⌘4,⌘9
Method of Malfunction Detection	Thermistor fault is detected based on the temperature determined by each thermistor
Malfunction Decision Conditions	When power is supplied and the input of thermistor is 4.96 V or more or 0.04 V or less * (for reference) In case of 120 Ω (equivalent to 212°C / 413.6°F) or less or 1860 kΩ (equivalent to -50°C / -58°F) or more
Supposed Causes	<ul style="list-style-type: none"> ■ Improper connector connection ■ Defective thermistor ■ Defective PCB for indoor unit control system ■ Defective PCB for indoor humidity sensor

Troubleshooting Chart



Check No.02
Refer to P.141

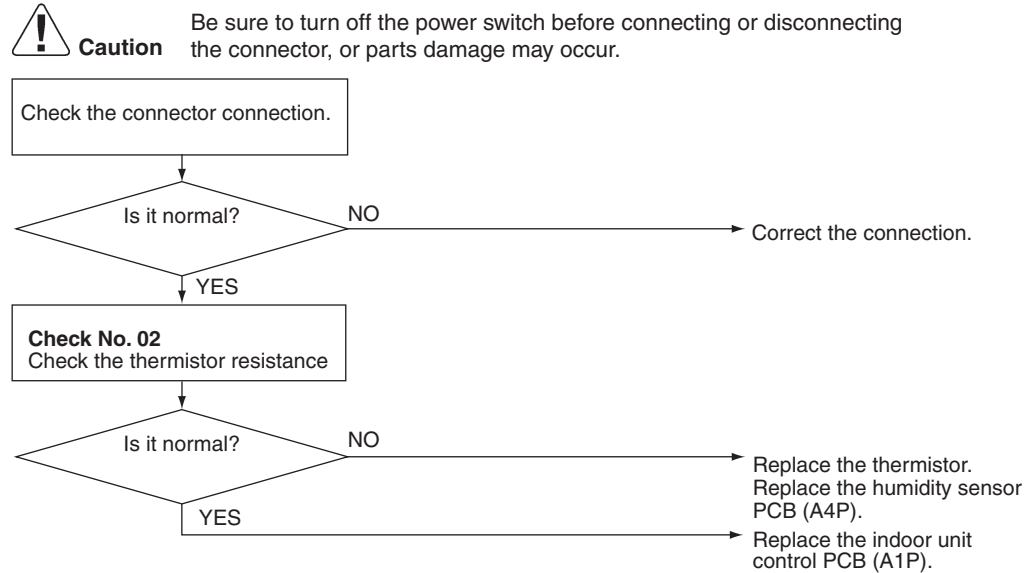

(R10120)

⌘4 : Indoor heat exchanger thermistor

⌘9 : Room temperature thermistor

2.11 Front Panel Open / Close Abnormality

Remote
Controller
Display



Method of
Malfunction
Detection

Malfunction
Decision
Conditions

- The system will be shut down when the error occurs twice.

Supposed
Causes

- Malfunction of the reduction motor
- Malfunction or deterioration of the front panel mechanism
- Malfunction of the limit switch

Troubleshooting

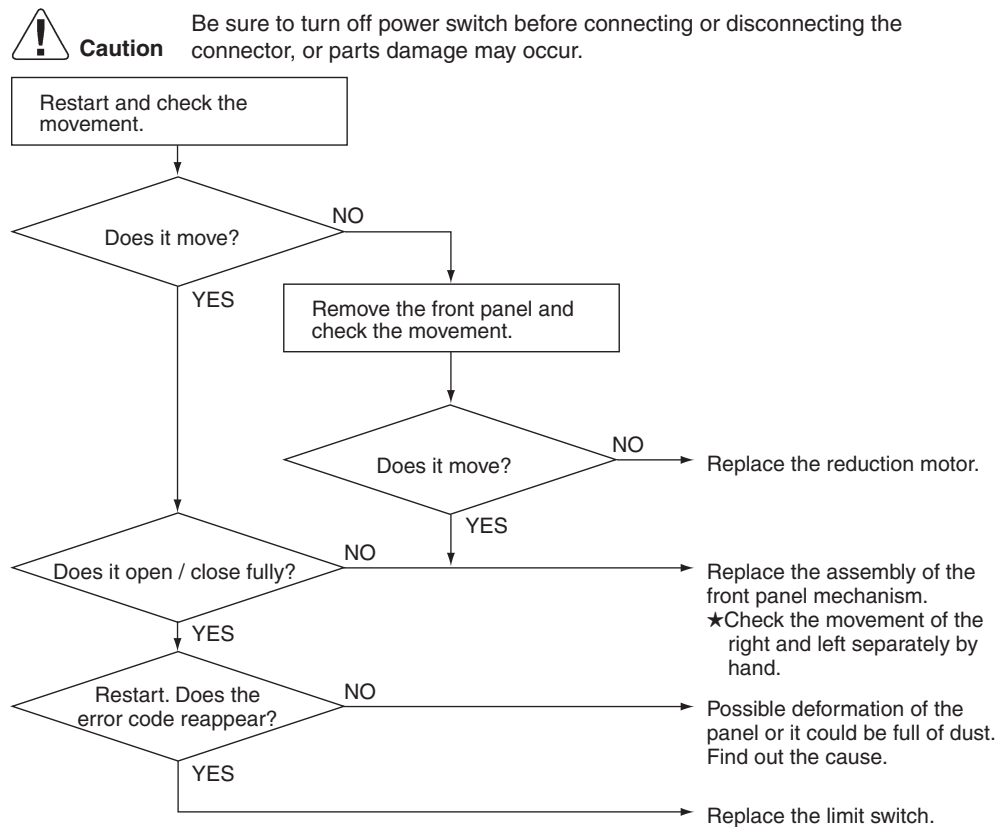

(R10115)



Note: You cannot operate the unit by the remote controller when the front panel mechanism breaks down.

<To the dealers: temporary measure before repair>

1. Turn the breaker off.
2. Remove the front panel.
3. Turn the breaker on.
(Wait until the initialization finishes.)
4. Operate the unit by the indoor unit ON/OFF switch.

2.12 Humidity Sensor Abnormality

Remote
Controller Display



Method of
Malfunction
Detection

Sensor fault is detected by input value.

Malfunction
Decision
Conditions

When the input from a temperature sensor is 4.96 V or more or 0.04 V or less*

Supposed
Causes

- Improper connector connection
- Defective indoor control PCB
- Defective humidity sensor PCB

Troubleshooting



Check No.27
Refer to P.151



Caution Be sure to turn off the power switch before connecting or disconnecting the connector, or parts damage may occur.

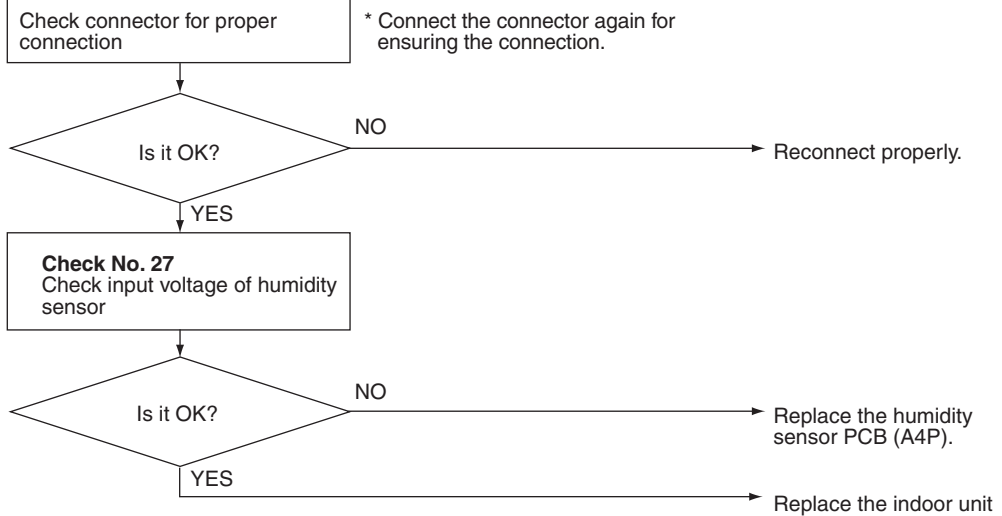

: Humidity sensor

(R10116)

2.13 Signal Transmission Error (Indoor Unit - Outdoor Unit)

**Remote
Controller Display**



**Method of
Malfunction
Detection**

The data sent from the outdoor unit is checked for problem.

**Malfunction
Decision
Conditions**

When the data sent from the outdoor unit can not be received without error, or when the disabled status of signal transmission continues for 15 seconds and the same status continuously repeats 3 times.

**Supposed
Causes**

- Defective outdoor unit PCB
- Defective indoor unit PCB
- Signal transmission error between indoor and outdoor unit due to improper wiring
- Signal transmission error between indoor and outdoor unit due to breakage of relay wire (transmission wire)

Troubleshooting



Caution Be sure to turn off the power switch before connecting or disconnecting the connector, or parts damage may occur.

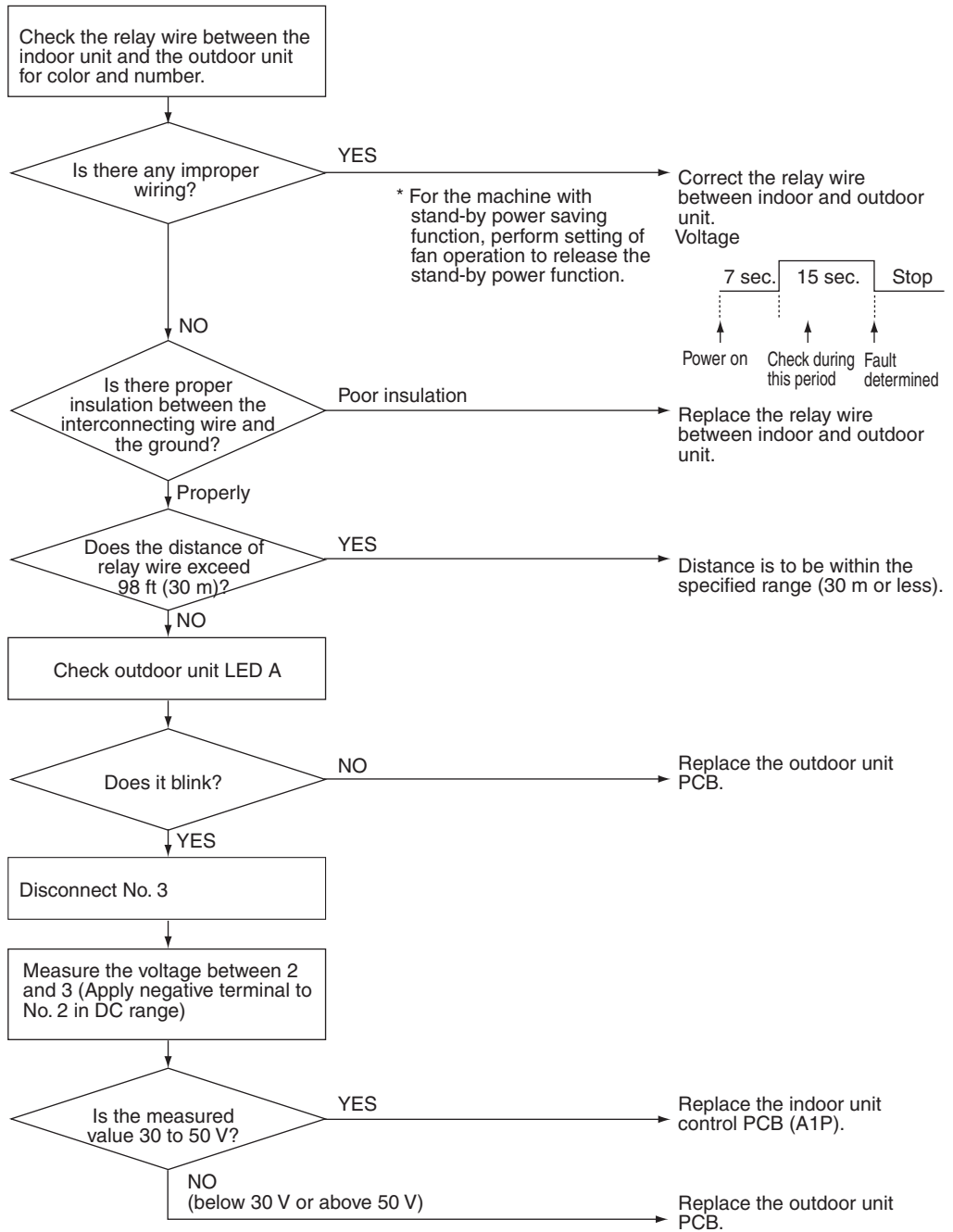

(R10121)

2.14 Incompatible Power Supply between Indoor Unit and Outdoor Unit

Remote
Controller Display



Method of
Malfunction
Detection

Check the incompatible power supply between the indoor unit and the outdoor unit by using signal transmission.

Method of
Malfunction
Detection

In case that the incorrect indoor model is connected to the incorrect outdoor model.

Supposed
Causes

- Connected to wrong model
- Mounted improper indoor unit PCB
- Defective indoor unit PCB
- Mounted improper outdoor unit PCB or defective PCB

Troubleshooting



Caution

Be sure to turn off the power switch before connecting or disconnecting the connector, or parts damage may occur.

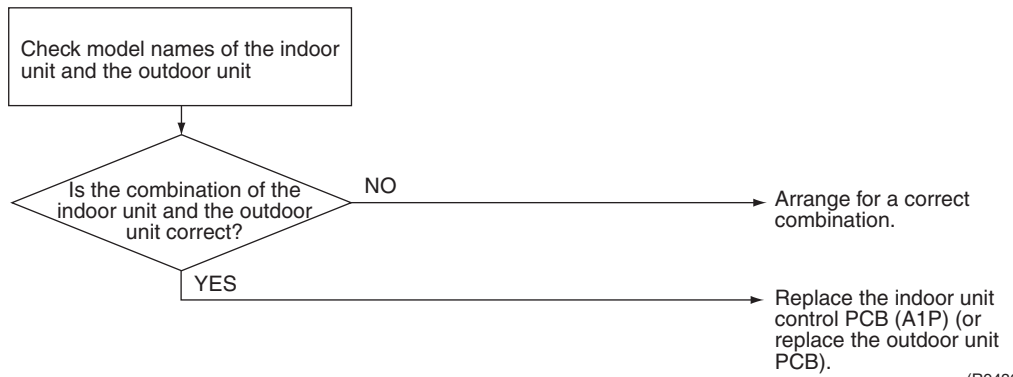

(R9436)

2.15 Outdoor Unit PCB Abnormality

Remote Controller Display



Outdoor Unit LED Display

A 5

Method of Malfunction Detection

- Detect within the program of the microcomputer if the program is in good running order.
- Detect input of zero-cross signal.

Malfunction Decision Conditions

- When the program of the microcomputer is in bad running order.
- Zero-cross signal can not be detected.

Supposed Causes

- Out of control of microcomputer caused by external factors
 - Noise
 - Momentary fall of voltage
 - Momentary power loss
- Defective outdoor unit PCB
- Breakage of harness between PCBs

Troubleshooting



Caution

Be sure to turn off the power switch before connecting or disconnecting the connector, or parts damage may occur.

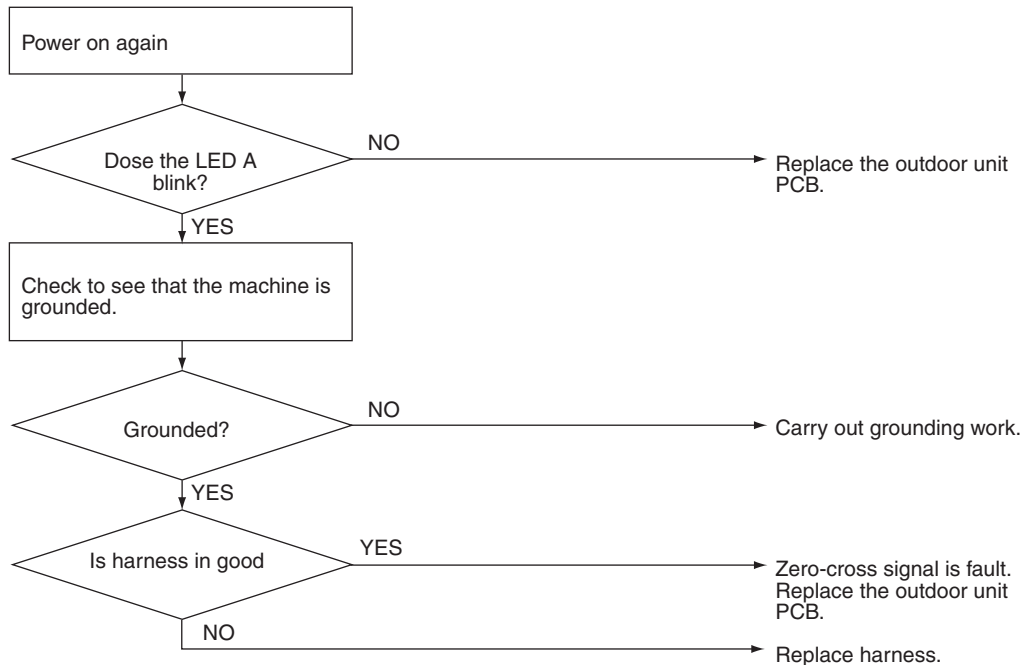

(R9437)

2.16 OL Activation (Compressor Overload)

Remote
Controller
Display



Method of
Malfunction
Detection

A compressor overload is detected through compressor OL.

Malfunction
Decision
Conditions

- If the compressor OL is activated twice, the system will be shut down.
 - The error counter will reset itself if this or any other error does not occur during the following 60-minute compressor running time (total time).
- * The operating temperature condition is not specified.

Supposed
Causes

- Refrigerant shortage
- Four-way valve malfunctioning
- Outdoor unit PCB defective
- Water mixed in the local piping
- Electronic expansion valve defective
- Stop valve defective

Troubleshooting



Check No.02
Refer to P.141



Check No.12
Refer to P.144



Check No.17
Refer to P.148



Check No.31
Refer to P.152



Caution Be sure to turn off the power switch before connecting or disconnecting the connector, or parts damage may occur.

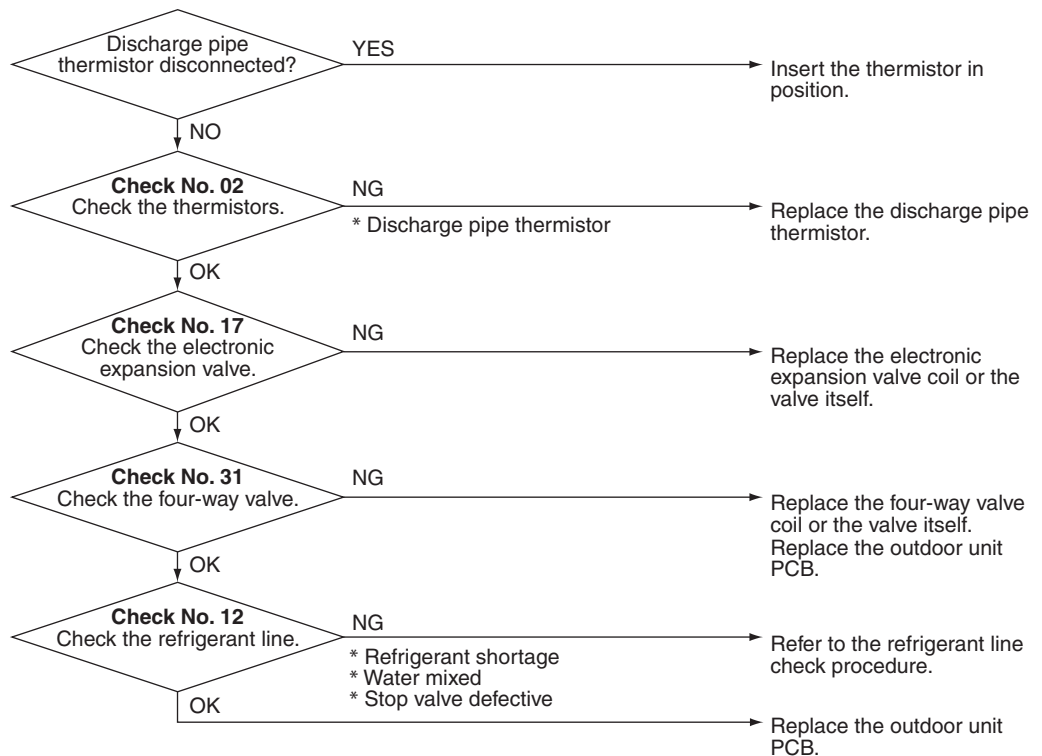

(R10122)

2.17 Compressor Lock

Remote Controller Display



Outdoor Unit LED Display

A0 50 (-)

Method of Malfunction Detection

Judging from current waveform generated when high-frequency voltage is applied to the compressor.

Malfunction Decision Conditions

- The machine is shut down when the fault count reaches 16.
- Clear condition: Continuous operation for 11 min. (without fault)

Supposed Causes

- Compressor lock
- Disconnection of compressor harness

Troubleshooting



Check No.14
Refer to P.145



Caution

Be sure to turn off the power switch before connecting or disconnecting connector, or parts damage may occur.

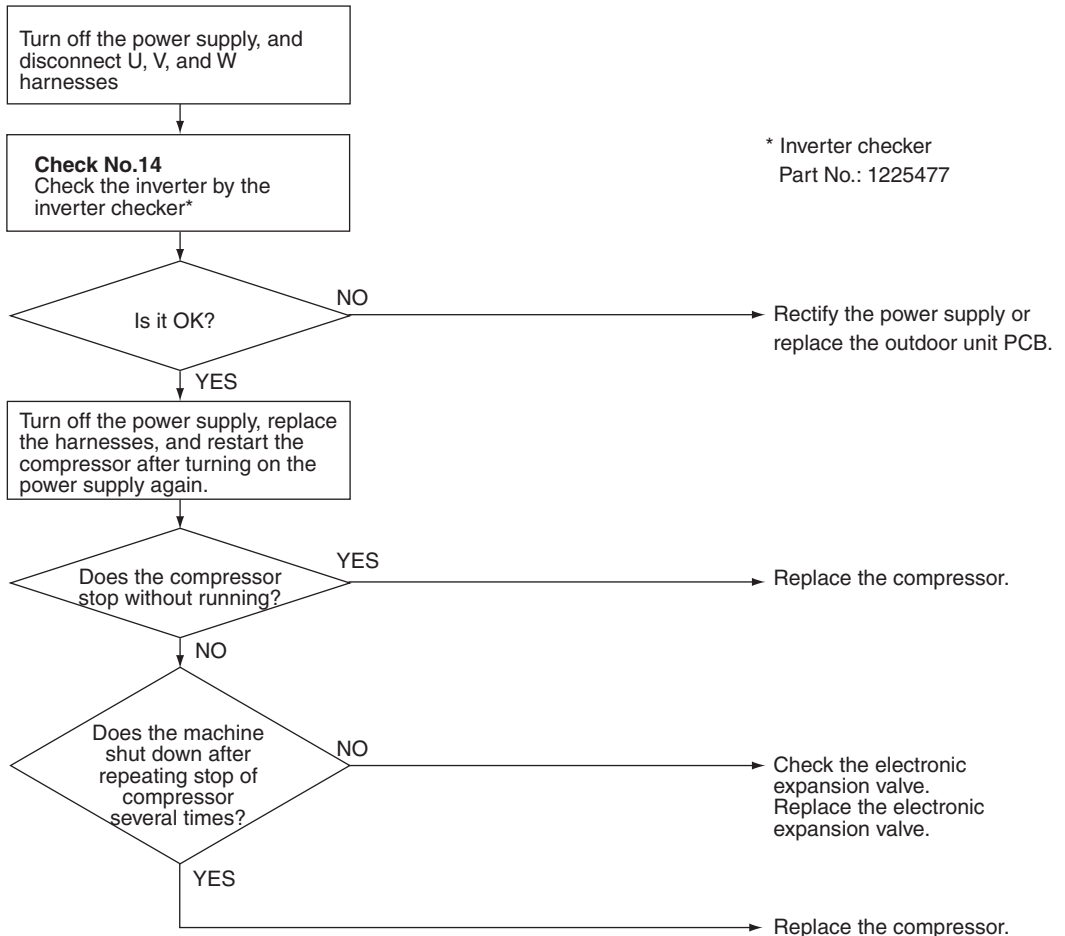

2.18 DC Fan Lock

Remote
Controller Display



Outdoor Unit LED
Display

A0 50 (-)

Method of
Malfunction
Detection

Identify the fan motor system fault based on the fan speed detected by Hall IC while the high pressure fan motor is running.

Malfunction
Decision
Conditions

- When the fan motor is running, the fan does not rotate for 60 seconds or more.
- Shut down when the error repeats 16 times
- Clear condition: The fan continuously rotates for 11 minutes without fault.

Supposed
Causes

- Failure in fan motor
- Disconnection or improper connection of harness/connector between fan motor and PCB
- The fan does not rotate because it gets caught in foreign matter

Troubleshooting



Check No.23
Refer to P.150



Caution

Be sure to turn off the power switch before connecting or disconnecting the connector, or parts damage may occur.

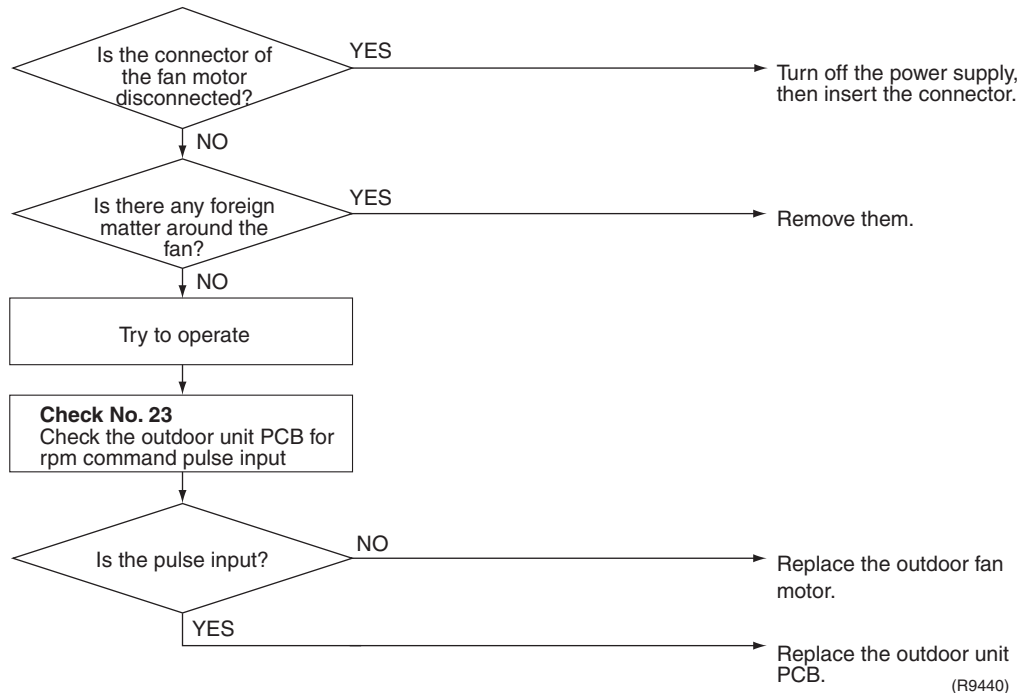

2.19 Input Overcurrent Detection

Remote Controller Display	EE
Outdoor Unit LED Display	A0 50 (-)
Method of Malfunction Detection	Detect an input overcurrent by checking the inverter power consumption or the input current detected by CT with the compressor running.
Malfunction Decision Conditions	<ul style="list-style-type: none"> ■ When 14 A or more of inverter power consumption or CT input continues for 5 seconds. ■ The compressor stops if the error occurs, and restarts automatically after 3 minutes standby.
Supposed Causes	<ul style="list-style-type: none"> ■ Overcurrent due to defective compressor ■ Overcurrent due to defective power transistor ■ Overcurrent due to defective electrolytic capacitor of inverter main circuit ■ Overcurrent due to defective outdoor unit PCB ■ Detection error due to defective outdoor unit PCB ■ Overcurrent due to short circuit

Troubleshooting



Check No.03
Refer to P.142



Check No.11
Refer to P.143



Check No.14
Refer to P.145



Check No.16
Refer to P.147



Caution Be sure to turn off the power switch before connecting or disconnecting the connector, or parts damage may occur.

*Input overcurrent may be caused by improper wiring inside the machine. If the machine stops due to input overcurrent after connecting or disconnecting wires to replaced part, check wiring for proper connection.

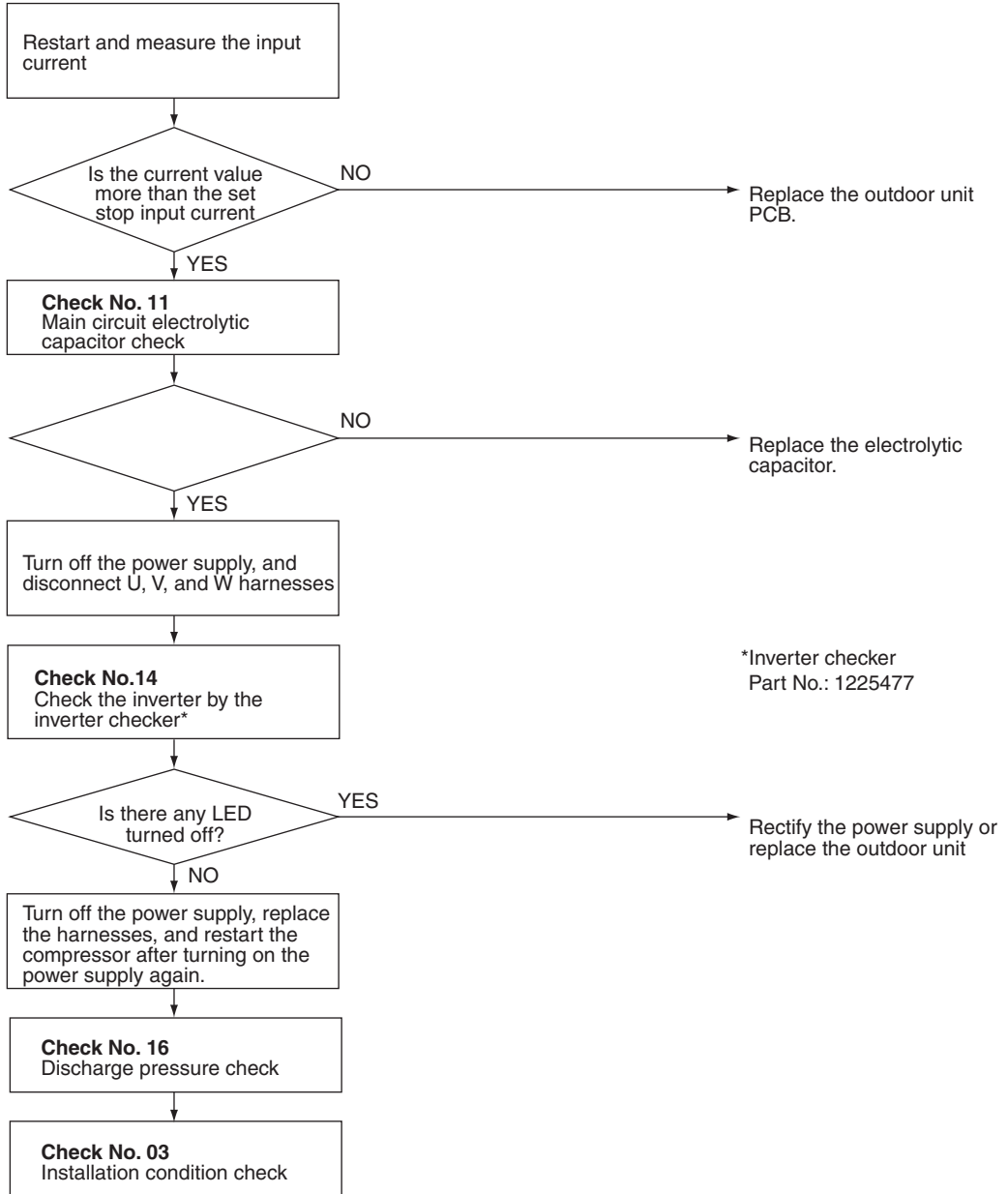

*Inverter checker
Part No.: 1225477

(R10123)

2.20 Four-Way Valve Abnormality

Remote
Controller Display

ER

Outdoor Unit LED
Display

A0 50 (-)

**Method of
Malfunction
Detection**

The room temperature thermistor, the indoor heat exchanger thermistor, the outdoor air thermistor, and the outdoor heat exchanger thermistor are checked to see if they function within their normal ranges in the operating mode.

**Malfunction
Decision
Conditions**

- When one of the following condition continues for 10 min, the compressor stops, and restarts automatically after 3 minutes standby.

Cooling / drying

(Room temperature – temperature of indoor heat exchanger) < – 5°C(23°F)

Heating

(Temperature of indoor heat exchanger – room temperature) < – 5°C(23°F)

- Shut down when the error repeats twice
- Clear condition : Continuous operation for 60 minutes.

**Supposed
Causes**

- Improper connector connection
- Defective thermistor
- Defective outdoor unit PCB
- Defective coil or harness of four way valve
- Defective four way valve
- Insufficient gas
- Foreign substance mixed in refrigerant

Troubleshooting



Check No.02
Refer to P.141



Check No.12
Refer to P.144



Check No.31
Refer to P.152

Caution Be sure to turn off the power switch before connecting or disconnecting the connector, or parts damage may occur.

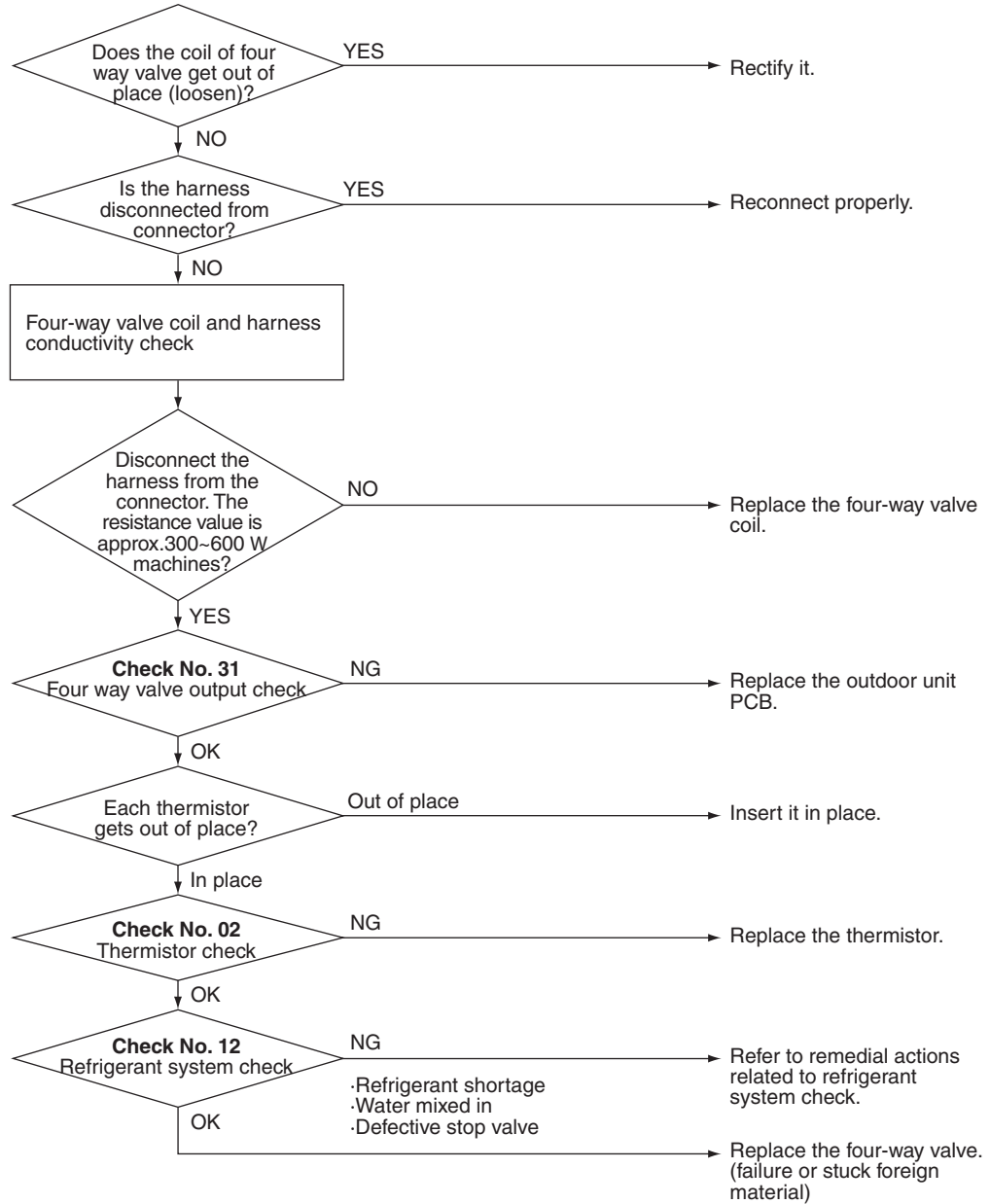

(R10117)

2.21 Discharge Pipe Temperature Control

Remote Controller Display



Outdoor Unit LED Display

A0 50 (-)

Method of Malfunction Detection

Discharge pipe temperature control (stop, frequency attenuation, etc.) is executed based on the temperature detected by the discharge pipe thermistor.

Malfunction Decision Conditions

- The compressor stops when the discharge pipe temperature is 118°C(244.4°F) or more. (Fault condition is cleared when the discharge pipe temperature is below 85°C(185°F))
- Shut down when the error repeats 4 times
- Clear condition : Continuous operation for 60 minutes

Supposed Causes

- Insufficient gas
- Faulty operation of four way valve
- Defective discharge pipe thermistor (Defective heat exchanger thermistor or outdoor air thermistor)
- Defective outdoor unit PCB
- Water mixed in the field piping
- Defective electronic expansion valve
- Defective stop valve
- Defective indoor electronic expansion valve

Troubleshooting



Check No.02
Refer to P.141



Check No.12
Refer to P.144



Check No.17
Refer to P.148



Caution

Be sure to turn off the power switch before connecting or disconnecting the connector, or parts damage may occur.

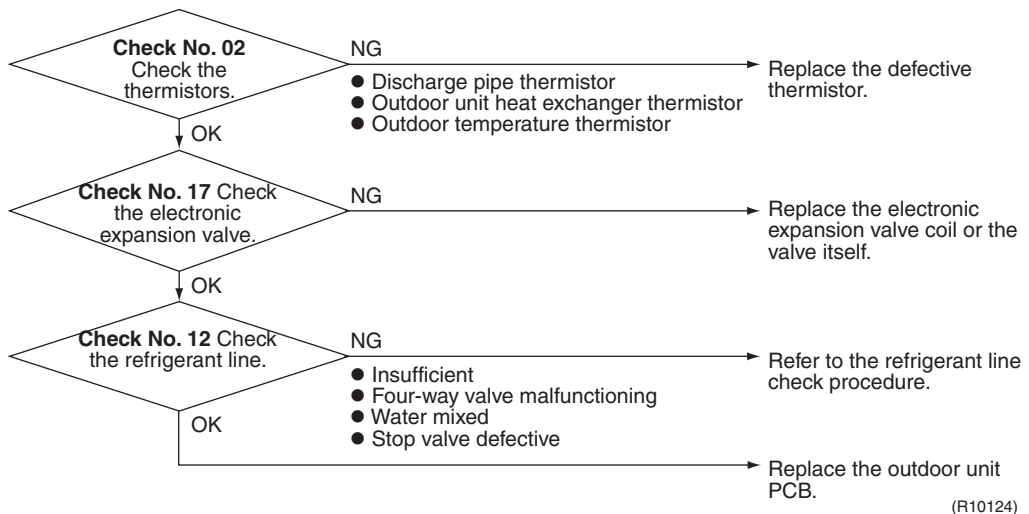

(R10124)

2.22 High Pressure Control in Cooling

Remote Controller Display	FE
Outdoor Unit LED Display	A0 50 (-)
Method of Malfunction Detection	During cooling, high pressure control (stop, frequency attenuation, etc.) is executed according to the temperature detected by the heat exchanger thermistor.
Malfunction Decision Conditions	During cooling, when the temperature detected by the heat exchanger thermistor is 63°C(145.4°F) or more. Fault condition is cleared when the temperature is below 45.5°C(113.9°F).
Supposed Causes	<ul style="list-style-type: none"> ■ Insufficient installation space ■ Defective outdoor fan ■ Defective electronic expansion valve ■ Defective heat exchanger thermistor ■ Defective outdoor unit PCB ■ Defective stop valve ■ Defective four-way valve for dehumidification

Troubleshooting



Check No.02
Refer to P.141



Check No.03
Refer to P.142



Check No.05
Refer to P.142



Check No.16
Refer to P.147



Check No.17
Refer to P.148



Check No.32
Refer to P.153



Caution

Be sure to turn off the power switch before connecting or disconnecting the connector, or parts damage may occur.

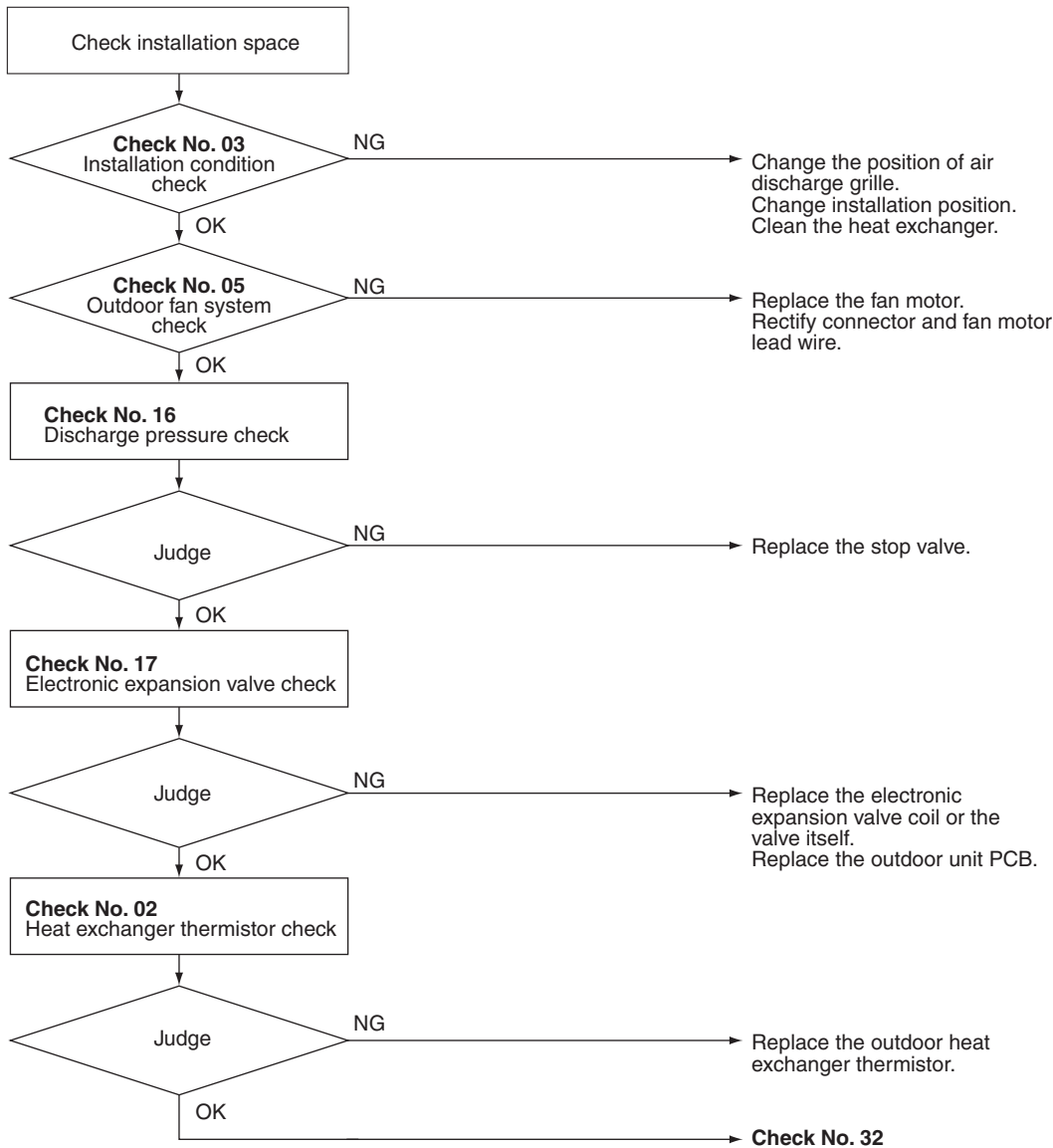

(R10125)

2.23 Compressor Sensor System Abnormality

Remote
Controller Display



Outdoor Unit LED
Display

A0 50 (-)

Method of
Malfunction
Detection

Fault condition is identified by DC current which is detected before compressor startup.

Malfunction
Decision
Conditions

- When the DC current before compressor startup is other than 0.5 to 4.5 V (detected by converting the sensor output to voltage), or the DC voltage is 50 V or less.

Supposed
Causes

- Defective PCB
- Harness disconnection / defective connection

Troubleshooting



Caution

Be sure to turn off the power switch before connecting or disconnecting the connector, or parts damage may occur.

Replace the outdoor unit PCB.

2.24 Position Sensor Abnormality

Remote Controller Display	HE
Outdoor Unit LED Display	A0 50 (-)
Method of Malfunction Detection	Startup failure of the compressor is identified by rpm information of the compressor and by the electric component position detector.
Malfunction Decision Conditions	<ul style="list-style-type: none"> ■ When the compressor does not run for 15 seconds after receiving operation start command ■ The machine shuts down if the fault occurs 16 times ■ Clear condition: The compressor continuously runs for 11 minutes without fault
Supposed Causes	<ul style="list-style-type: none"> ■ Detection error due to disconnection of compressor harness ■ Startup failure due to defective compressor ■ Startup failure due to defective outdoor unit PCB ■ Startup failure due to closed stop valve ■ Input voltage fault

Troubleshooting



Check No.14
Refer to P.145



Check No.16
Refer to P.147



Check No.29
Refer to P.151



Caution Be sure to turn off the power switch before connecting or disconnecting the connector, or parts damage may occur.

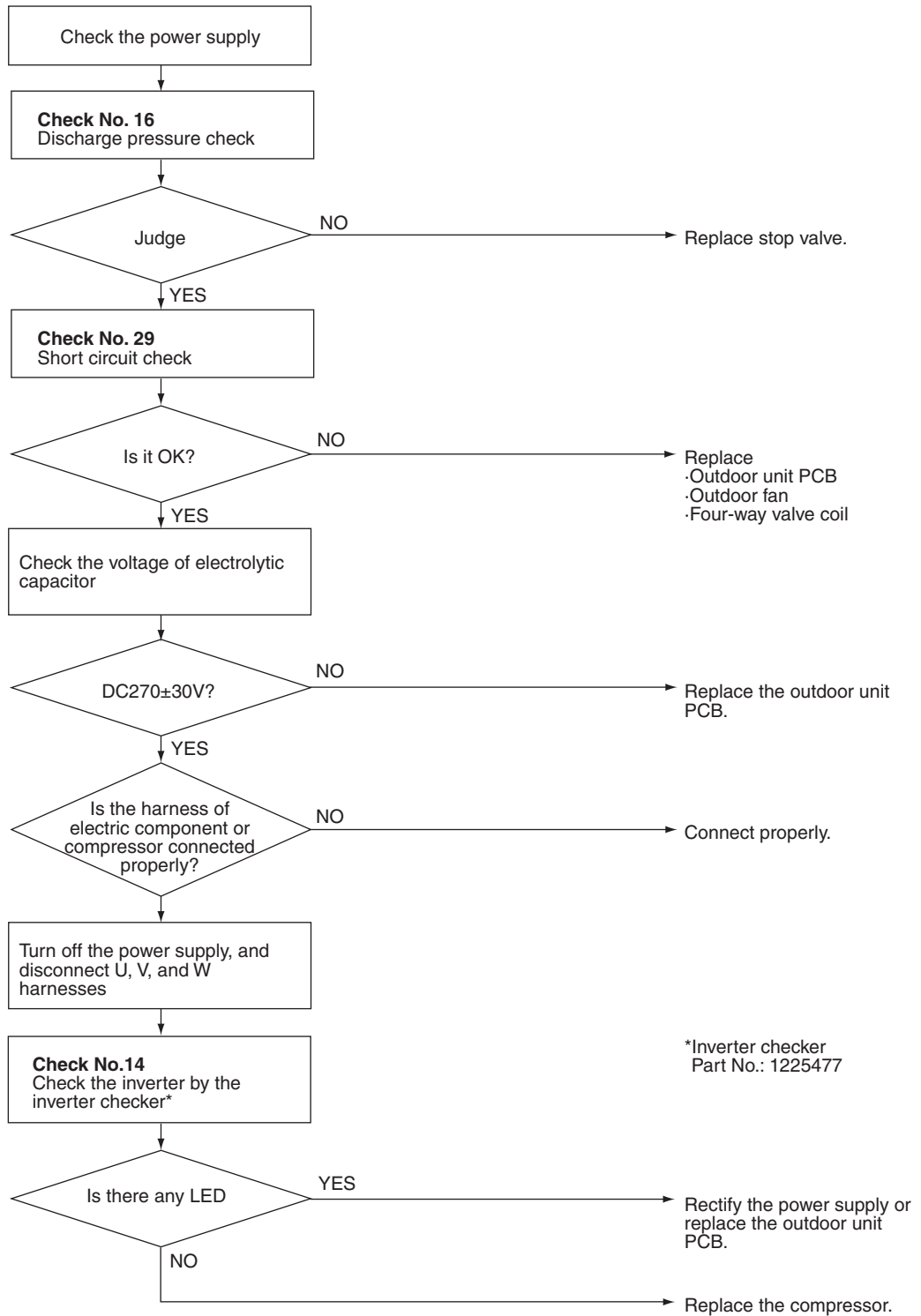

*Inverter checker
Part No.: 1225477

(R10126)

2.25 DC Voltage / DC Current Sensor Abnormality

Remote
Controller Display



Outdoor Unit LED
Display

A0 50 (-)

Method of
Malfunction
Detection

DC voltage or DC current sensor system fault is identified based on the compressor operation frequency and the input current detected by the product of DC current and DC voltage.

Malfunction
Decision
Conditions

When the compressor operation frequency is more than 62 Hz and when the input current is less than 0.25 A for 90 sec. continuously

- The machine shuts down when the fault occurs 4 times.
- Fault counter will be reset to zero if the machine does not stop during accumulated compressor operation time of 60 minutes after restored from fault conditions.

Supposed
Causes

- Defective outdoor unit PCB

Troubleshooting



Caution

Be sure to turn off the power switch before connecting or disconnecting the connector, or parts damage may occur.

Replace the outdoor unit PCB.

2.26 Thermistor System Abnormality

Remote Controller Display	P4, U3, U6, H9
Outdoor Unit LED Display	A0 5 -
Method of Malfunction Detection	This fault is identified based on the thermistor input voltage to the microcomputer. A thermistor fault is identified based on the temperature detected by each thermistor.
Malfunction Decision Conditions	When power is supplied and the thermistor input is 4.98 V or more or when the thermistor input is 0.02 V or less for 5 seconds continuously For U3, “Discharge pipe thermistor < heat exchanger thermistor” is taken into consideration to identify the fault.
Supposed Causes	<ul style="list-style-type: none"> ■ Improper connection of connector ■ Defective thermistor ■ Defective indoor unit PCB ■ For U3, defective heat exchanger thermistor (Cooling: outdoor heat exchanger thermistor, heating: indoor heat exchanger thermistor)

Troubleshooting



Check No.02
Refer to P.141



Caution Be sure to turn off the power switch before connecting or disconnecting the connector, or parts damage may occur.

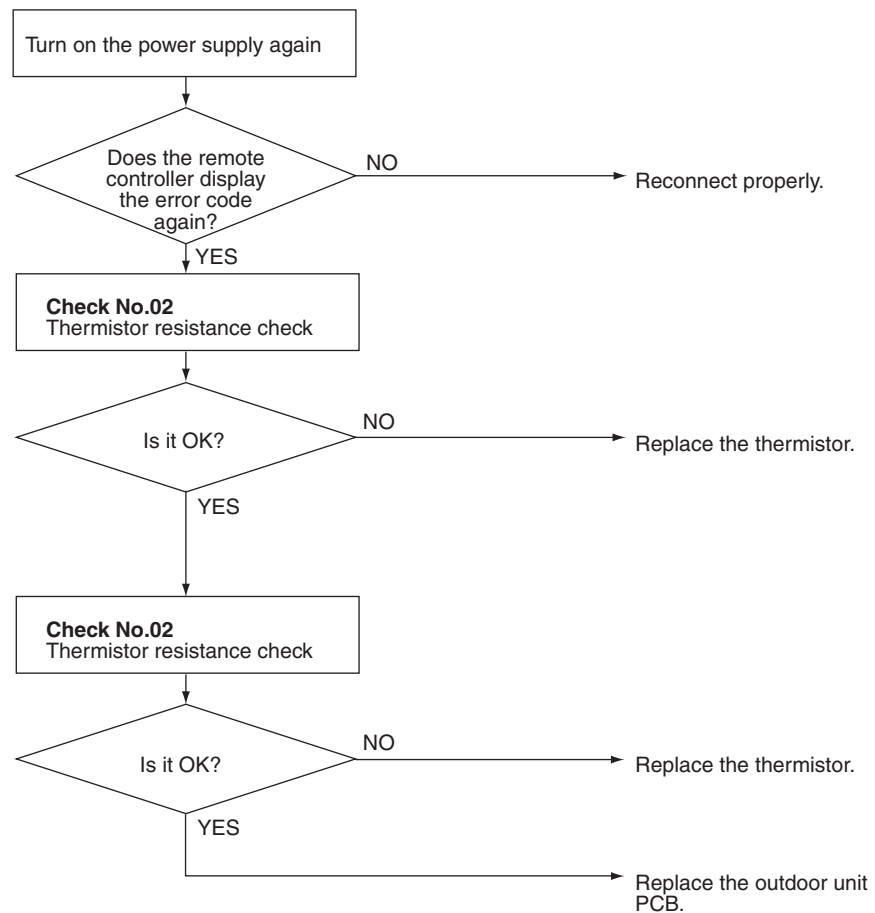

(R9446)

P4 : Radiation fin thermistor
 J3 : Discharge pipe thermistor
 J5 : Outdoor heat exchanger thermistor
 H3 : Outdoor air thermistor

2.27 Abnormal Temperature in Electrical Box

Remote Controller Display	L3
Outdoor Unit LED Display	A0 5 -
Method of Malfunction Detection	Temperature rise in the electrical box is identified based on the temperature of the radiation fin detected by the fin thermistor with the compressor off.
Malfunction Decision Conditions	When the temperature of the radiation fin is 122°C(251.6°F) or more during the compressor off. (When the temperature drops below 113°C(235.4°F), fault condition is cleared.)
Supposed Causes	<ul style="list-style-type: none"> ■ Fin temperature rise due to defective outdoor fan ■ Fin temperature rise due to short circuit ■ Detection error due to defective fin thermistor ■ Detection error due to improper connection of connector ■ Detection error due to defective outdoor unit PCB

Troubleshooting



Check No.02
Refer to P.141



Check No.03
Refer to P.142



Check No.05
Refer to P.142



Caution Be sure to turn off the power switch before connecting or disconnecting the connector, or parts damage may occur.

(Note on resetting power supply)
To reset the machine, power off status need to continue at least 30 sec.

Turn off the power and turn it on again.



WARNING

To cool down the electric components, the outdoor unit fan gets started when the radiation fin temperature rises above 120°C(248°F) and stops when the temperature falls below 113°C(235.4°F).

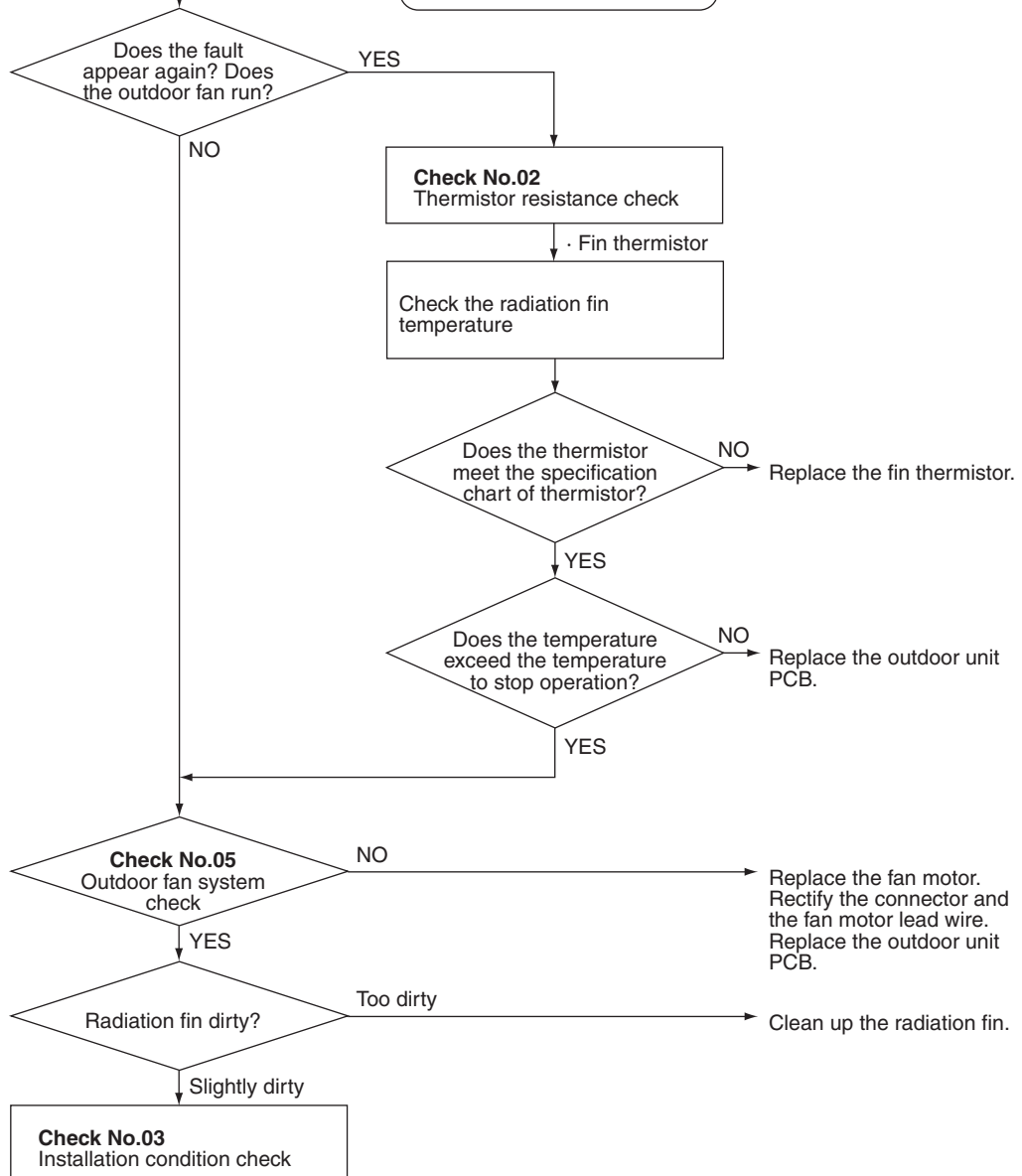



(R9447)

2.28 Temperature Rise in Radiation Fin

Remote Controller Display	L4
Outdoor Unit LED Display	A0 50
Method of Malfunction Detection	Temperature rise in the radiation fin is identified based on the temperature of the radiation fin detected by the fin thermistor with the compressor on.
Malfunction Decision Conditions	<ul style="list-style-type: none"> ■ The compressor stops when the radiation fin temperature is 86 °C (186.8°F) or more. Fault condition is cleared when the radiation fin temperature is below 67 °C (152.6°F). ■ Shut down when the error repeats.
Supposed Causes	<ul style="list-style-type: none"> ■ Fin temperature rise due to defective outdoor fan ■ Fin temperature rise due to short circuit ■ Detection error due to defective fin thermistor ■ Detection error due to improper connection of connector ■ Detection error due to defective outdoor unit PCB

Troubleshooting

-  **Check No.02**
Refer to P.141
-  **Check No.03**
Refer to P.142
-  **Check No.05**
Refer to P.142

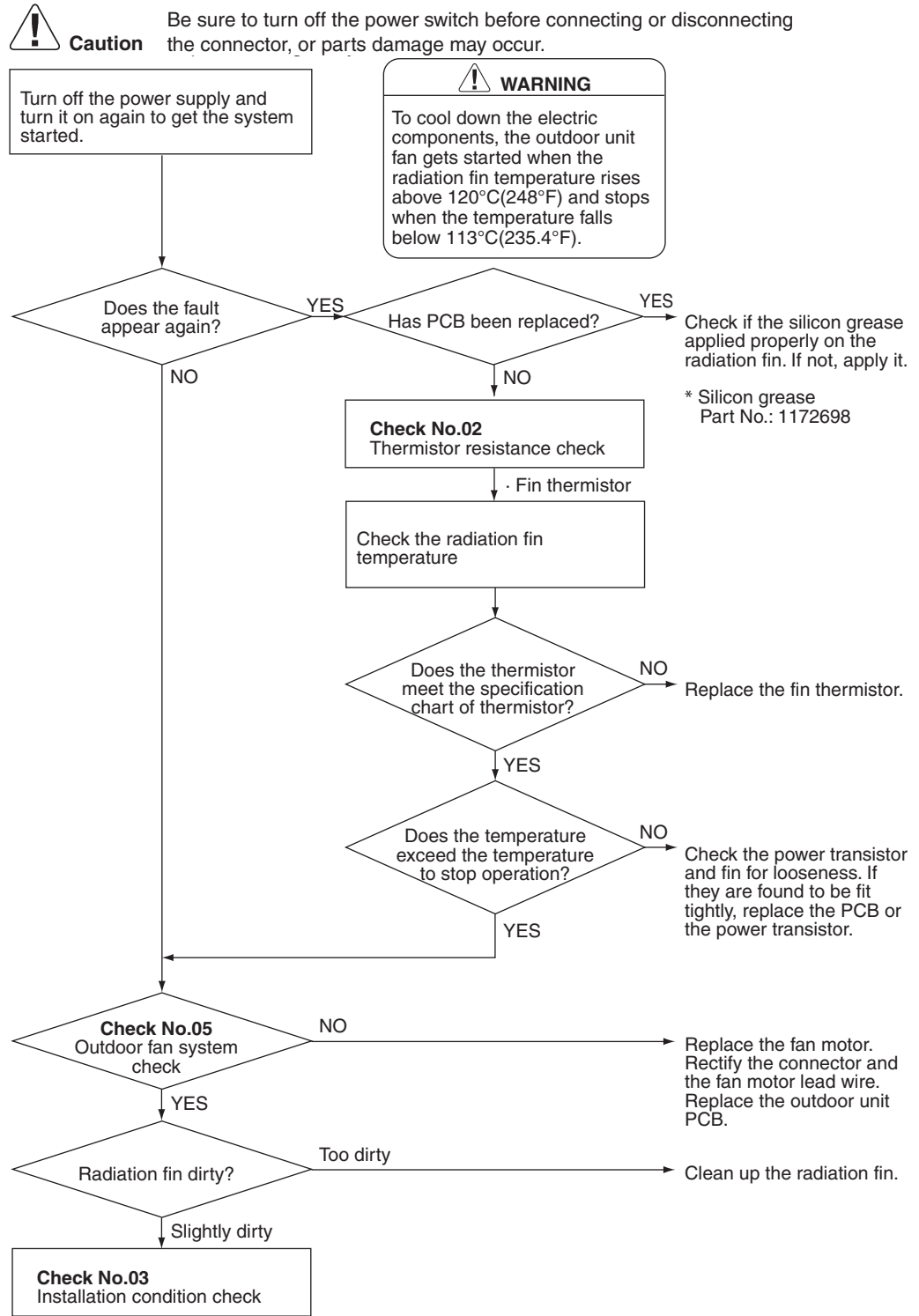

(R9448)



Note: Refer to “1.3 Application of Silicon grease to a power transistor and a diode bridge” on P. 234.

2.29 Output Overcurrent

Remote
Controller Display

LS

Outdoor Unit LED
Display

A0 50

Method of
Malfunction
Detection

An output overcurrent is detected by checking the current that flows in the inverter DC section.

Malfunction
Decision
Conditions

- A position signal error occurs while the compressor is running.
- A speed error occurs while the compressor is running.
- The machine shuts down when the signal of output overcurrent is sent 8 times from the output overcurrent detection circuit to the microcomputer.
- Clear condition: The machine continuously runs for about 11 minutes (without fault).

Supposed
Causes

- Overcurrent due to defective power transistor
- Overcurrent due to wrong internal wiring
- Overcurrent due to abnormal supply voltage
- Overcurrent due to defective PCB
- Detection error due to defective PCB
- Overcurrent due to closed stop valve
- Overcurrent due to defective compressor
- Overcurrent due to poor installation condition
- Defective indoor solenoid valve

Troubleshooting

- 

Check No.03
Refer to P.142
- 

Check No.14
Refer to P.145
- 

Check No.15
Refer to P.146
- 

Check No.16
Refer to P.147

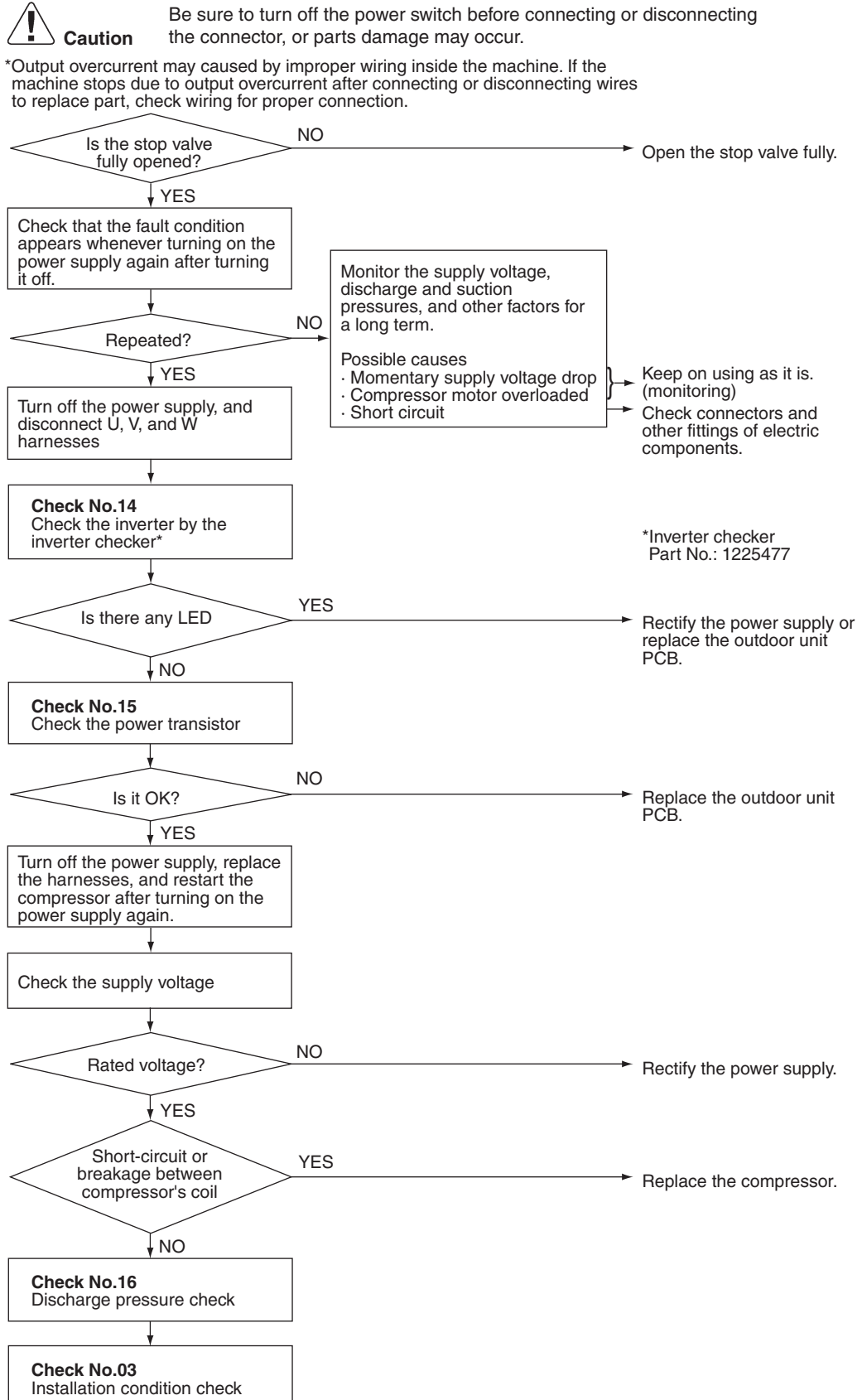

(R9449)

2.30 Insufficient Gas

Remote
Controller Display



Outdoor Unit LED
Display

A Φ 5 Φ (-)

Method of
Malfunction
Detection

Gas shortage detection I:

Gas shortage is detected by checking the input current value and the compressor running frequency. If the gas is short, the input current is smaller than the normal value.

Gas shortage detection III:

Gas shortage is detected by checking the difference between ambient temperature and heat exchanger temperature. If the gas is short, the difference is smaller than the normal value.

Malfunction
Decision
Conditions

Gas shortage detection I:

The following conditions continue for 7 minutes.

- ◆ Input current × input voltage ≤ 2800 / 256 × output frequency – 350 (W)
- ◆ Output frequency > 54 (Hz)

Gas shortage detection III:

When the difference of the temperature is smaller than Δ , it is regarded as insufficient gas.

		Δ
Cooling	room temperature – indoor heat exchanger temperature	4.0°C (7.2°F)
	outdoor heat exchanger temperature – outdoor temperature	4.0°C (7.2°F)
Heating	indoor heat exchanger temperature – room temperature	4.0°C (7.2°F)
	outdoor temperature – outdoor heat exchanger temperature	4.0°C (7.2°F)

If a gas shortage error takes place 4 times straight, the system will be shut down. The error counter will reset itself if this or any other error does not occur during the following 60-minute compressor running time (total time).

Supposed
Causes

- Refrigerant shortage (refrigerant leakage)
- Refrigerant heat exchanger drift
- Poor compression performance of compressor
- Closed stop valve
- Defective electronic expansion valve
- Defective solenoid valve for dehumidifying

Troubleshooting



Check No.02
Refer to P.141



Check No.17
Refer to P.148

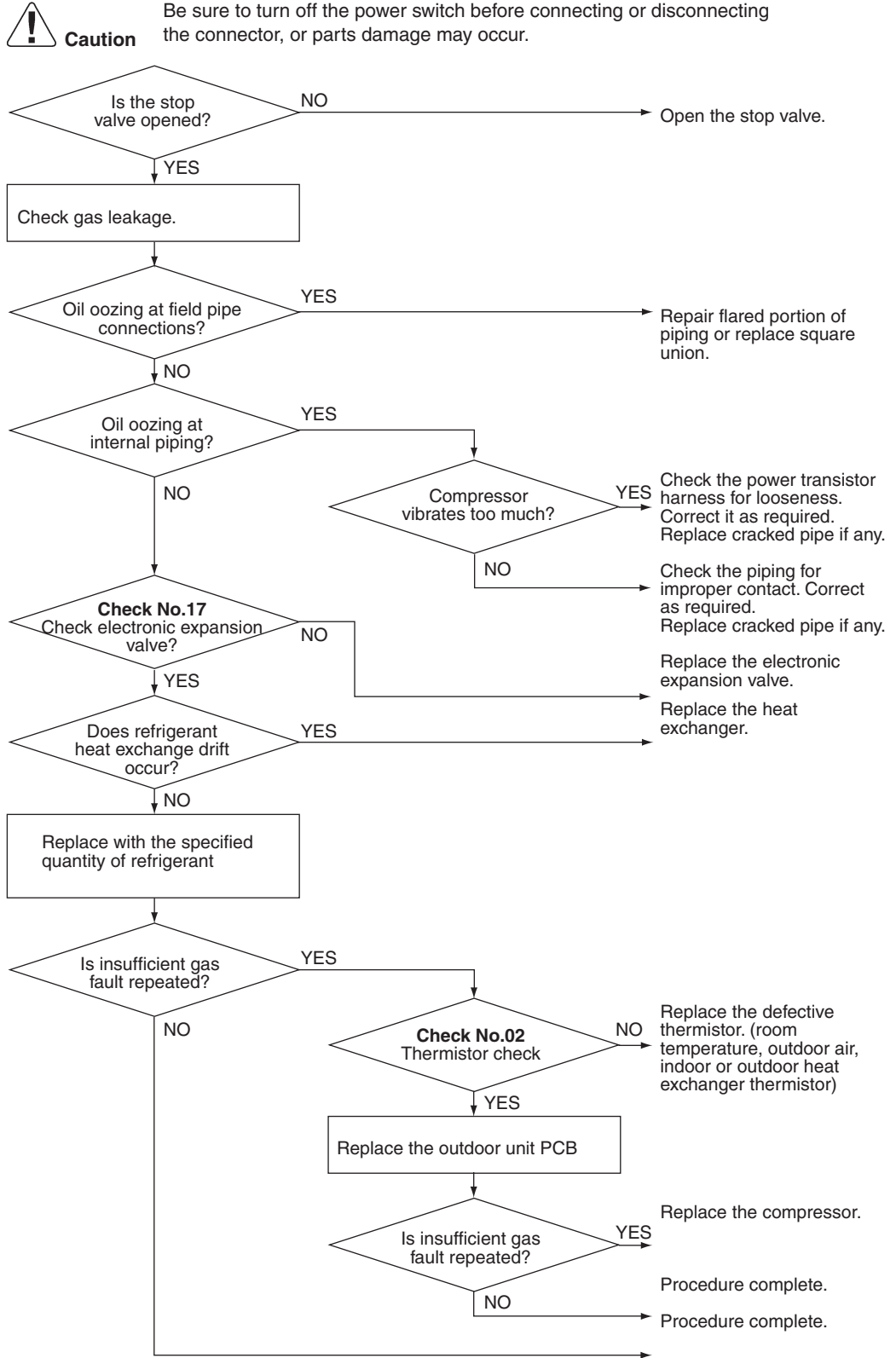

(R9450)

2.31 Over Voltage Protection / Low Voltage Protection

Remote
Controller Display



Outdoor Unit LED
Display

A0 50 (-)

Method of
Malfunction
Detection

Detect an abnormal increase or drop of voltage by the detection circuit or DC voltage detection circuit.

Malfunction
Decision
Conditions

- When an overcurrent signal is sent to the microcomputer from the overcurrent detection circuit, or the voltage detected by DC voltage detection circuit is less than 150 V and that voltage continues for about 0.1 sec.
- Shut down when the error repeats.
- Fault counter is reset when the machine continuously runs for 11 minutes without fault.

Supposed
Causes

- Abnormal supply voltage, momentary power failure
- Defective overcurrent detector or defective DC voltage detection circuit
- Failure in PAM controlled parts
- Short circuit inside the fan motor winding

Troubleshooting

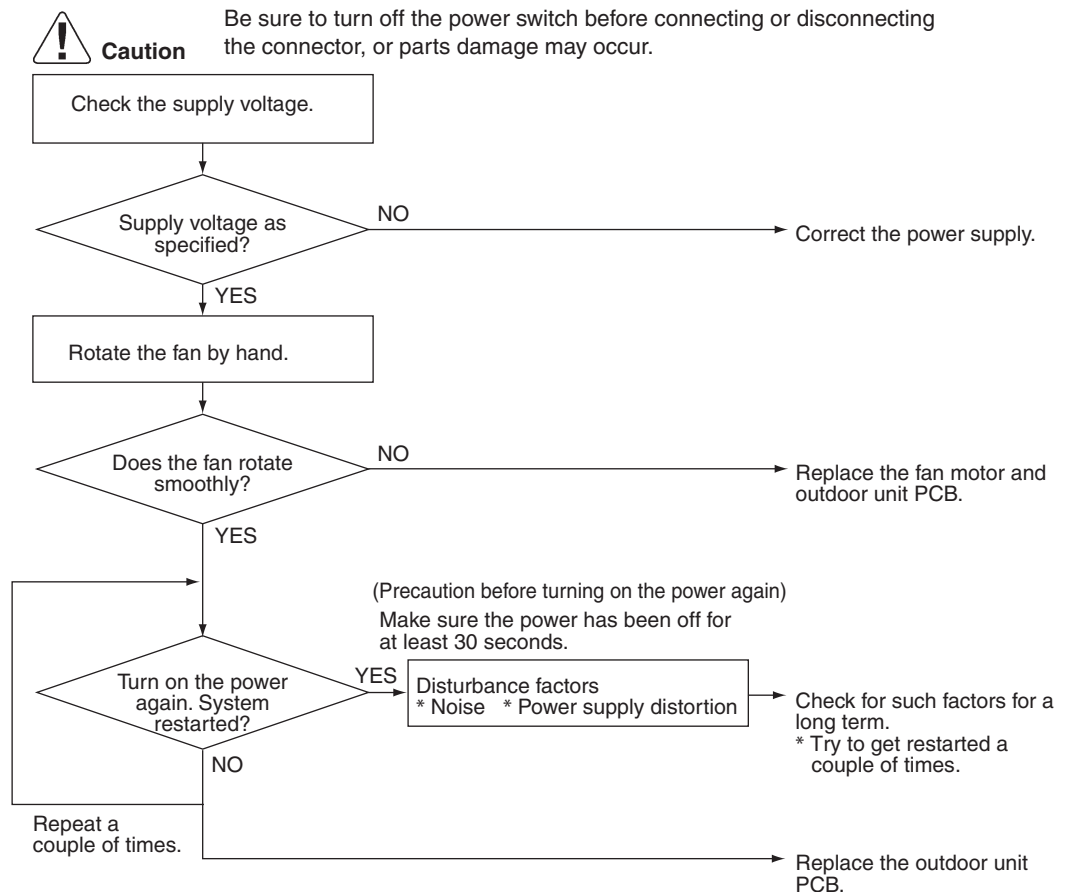

(R9451)

2.32 Outdoor Unit PCB Abnormality or Communication Circuit Abnormality

Remote Controller Display	U4
Outdoor Unit LED Display	A0 5 -
Method of Malfunction Detection	Detect within the program of the microcomputer whether or not the program is in good running order.
Malfunction Decision Conditions	<ol style="list-style-type: none"> 1. When the program of the microcomputer is in bad running order. 2. When indoor-outdoor unit signal transmission can not be performed for more than 15 seconds. 3. When zero-cross signal can not be detected for more than 10 seconds.
Supposed Causes	<ul style="list-style-type: none"> ■ Display disabled due to power supply fault ■ Communication circuit fault in outdoor unit PCB ■ Out of control of microcomputer caused by external factors <ul style="list-style-type: none"> ● Noise ● Momentary voltage drop ● Momentary power loss ■ Defective outdoor unit PCB ■ Defective thermal fuse in outdoor terminal board

Troubleshooting



Caution Be sure to turn off the power switch before connecting or disconnecting the connector, or parts damage may occur.

Check indoor unit also, because a communication circuit fault may be caused by the problem related to the indoor unit.

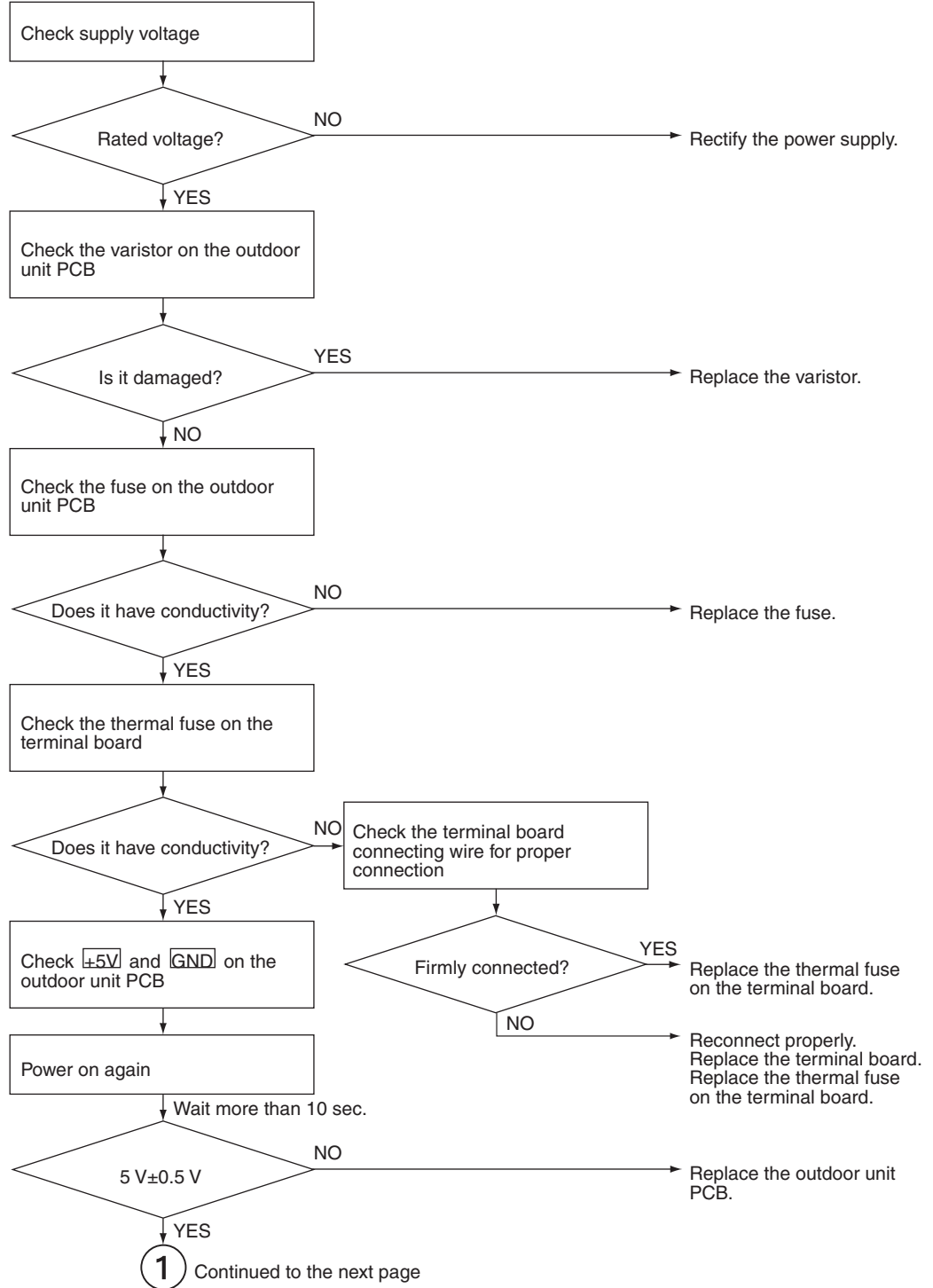

(R10127)



Check No.08
Refer to P.143

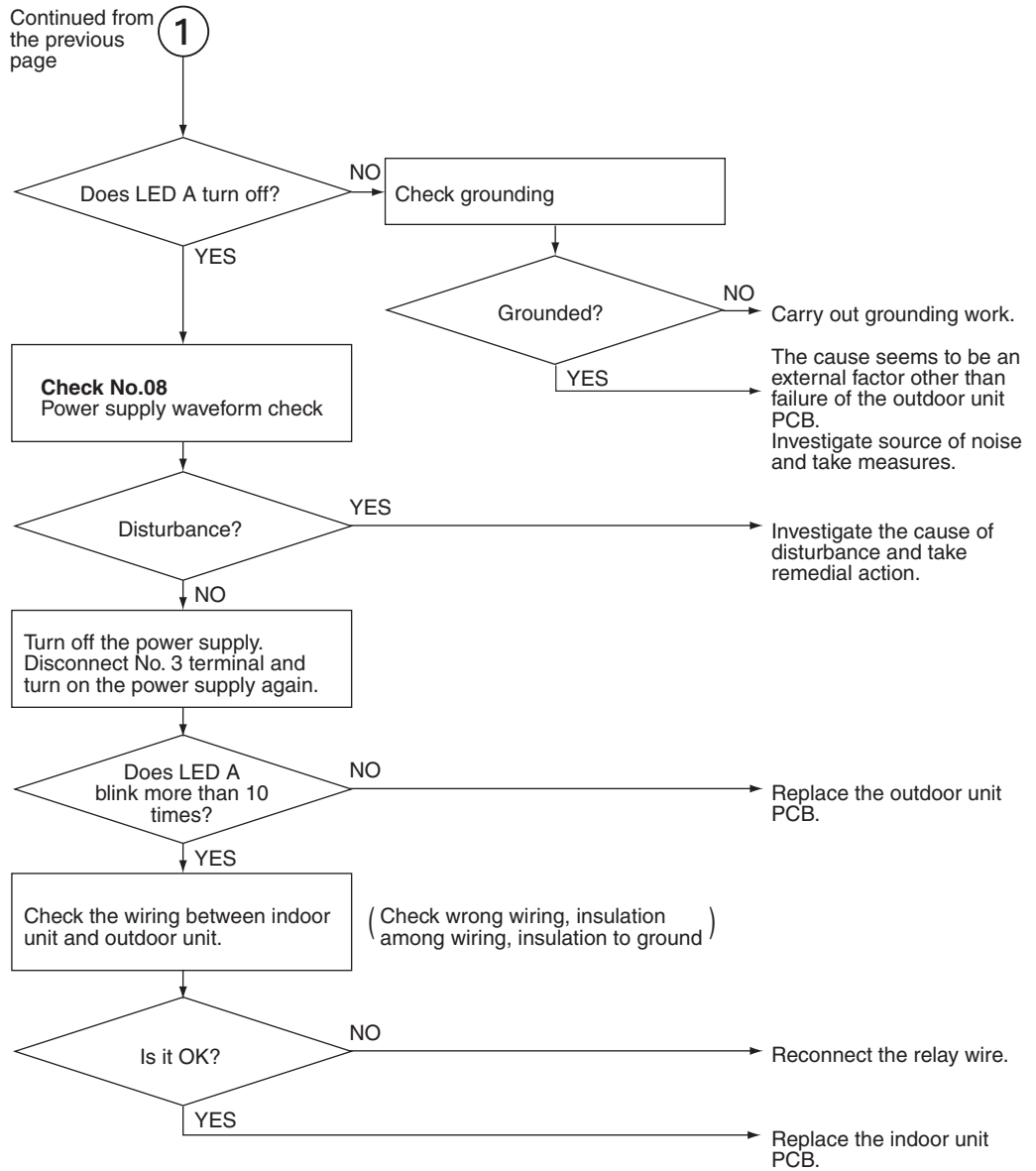

(R10128)

2.33 Signal Transmission Error on Outdoor Unit PCB

Remote Controller Display	U7
Outdoor Unit LED Display	A0 50 (-)
Method of Malfunction Detection	Communication error between microcomputer mounted on the main body and inverter.
Malfunction Decision Conditions	<ul style="list-style-type: none"> ■ When the data sent from the microcomputer of the inverter can not be received 15 times successively or for 15 sec, the machine shuts down. ■ Fault counter is reset when the data from the microcomputer of the inverter can be successfully received.
Supposed Causes	<ul style="list-style-type: none"> ■ Defective outdoor unit PCB ■ Disconnection or breakage of harness between PCBs

Troubleshooting

**Caution**

Be sure to turn off the power switch before connecting or disconnecting the connector, or parts damage may occur.

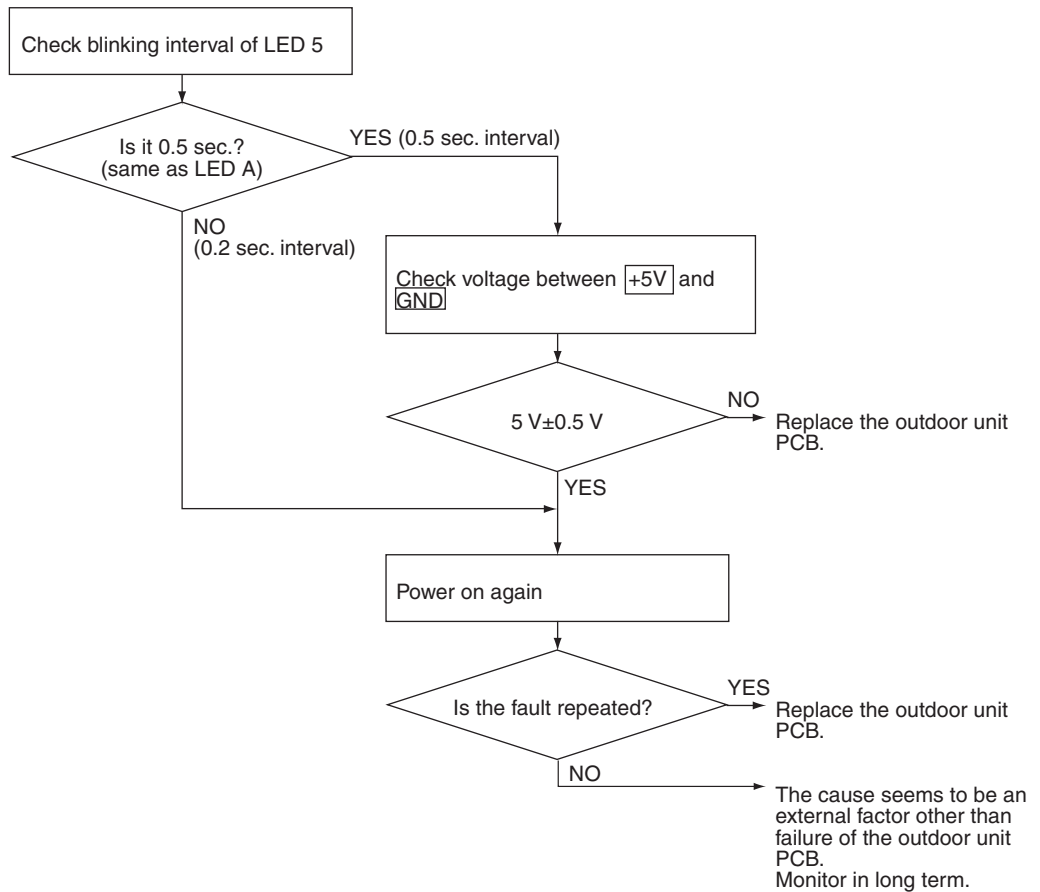

(R10129)

2.34 Lights-out of Microcomputer Status Lamp

Remote Controller Display —

Outdoor Unit LED Display A ● 5 ● (-)

Method of Malfunction Detection When a microcomputer fault is detected, LED A or LED 5 turns off.

Malfunction Decision Conditions

- Outdoor unit PCB has no power
- Power supply failure due to noise

Troubleshooting



Caution

Be sure to turn off the power switch before connecting or disconnecting the connector, or parts damage may occur.

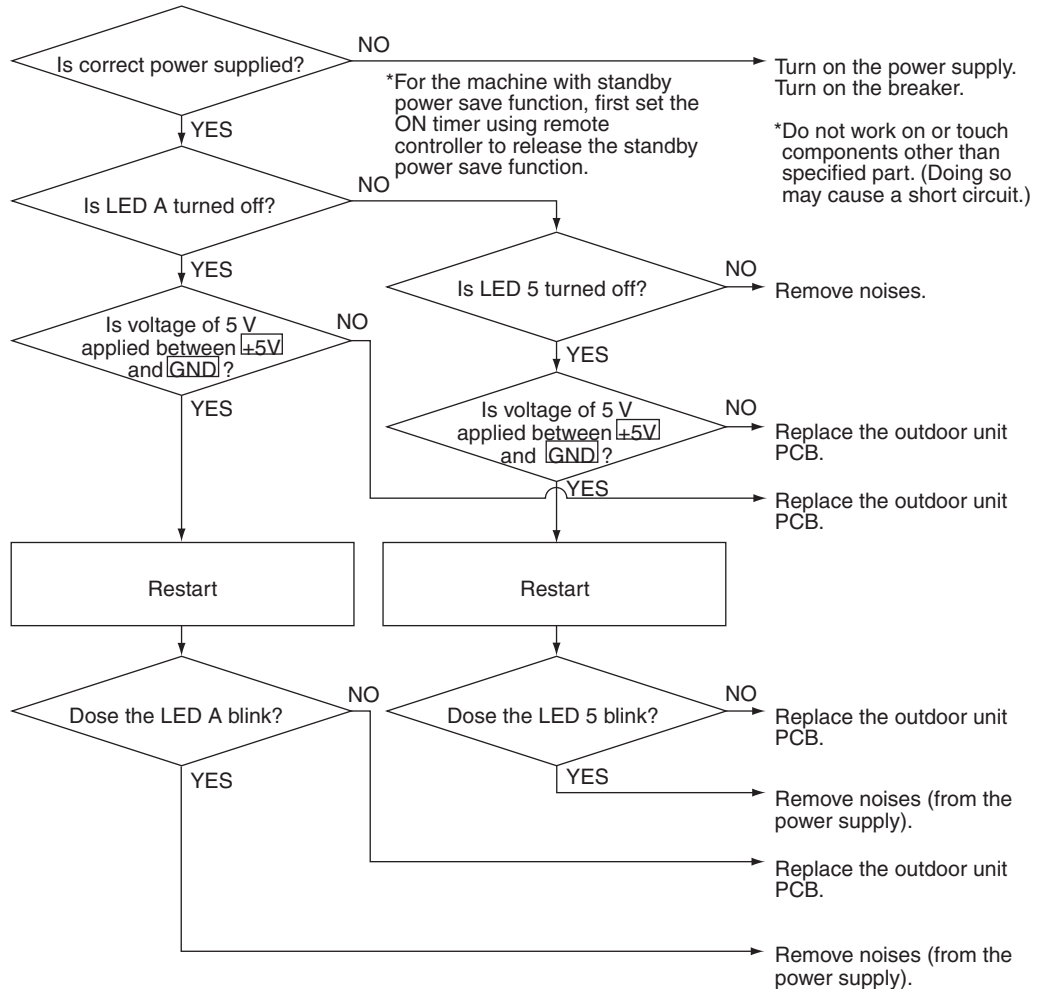

(R9458)

3. Check

3.1 Thermistor Resistance Check

Check No.02

Remove the connectors of the thermistors on the PCB, and measure the resistance of each thermistor using tester.

The relationship between normal temperature and resistance is shown in the graph and the table below.

Thermistor	R25°C(77°F)=20kΩ B=3950
Temperature (°C / °F)	
-20 / -4	211.0 (kΩ)
-15 / 5	150
-10 / 14	116.5
-5 / 23	88
0 / 32	67.2
5 / 41	51.9
10 / 50	40
15 / 59	31.8
20 / 68	25
25 / 77	20
30 / 86	16
35 / 95	13
40 / 104	10.6
45 / 113	8.7
50 / 122	7.2

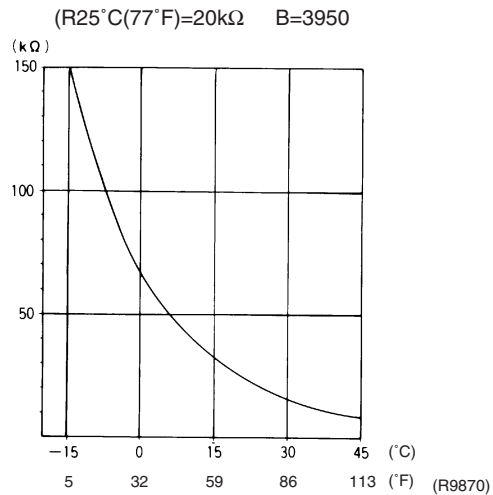
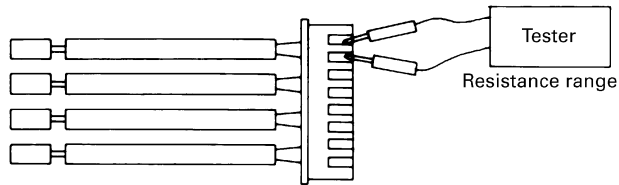

- For the models in which the thermistor is directly mounted on the PCB.

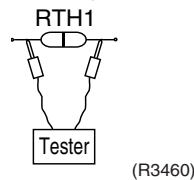

3.2 Installation Condition Check

Check No.03

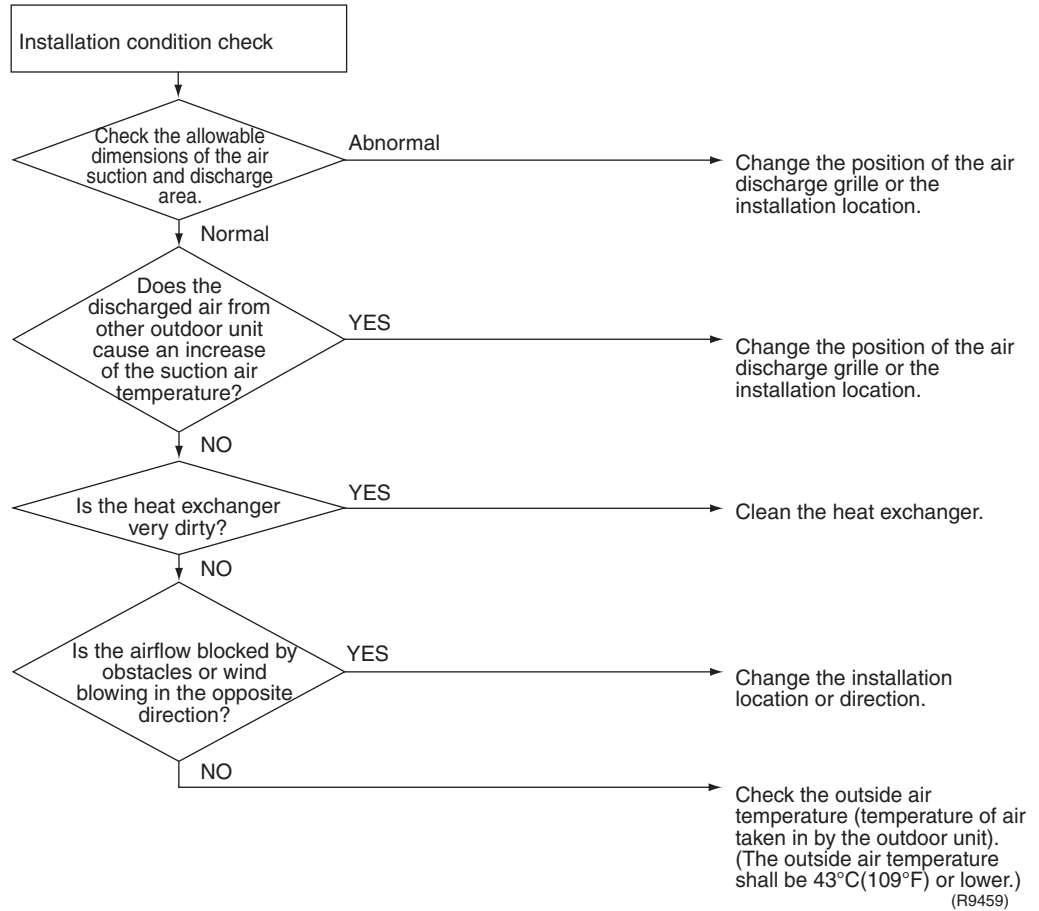

3.3 Outdoor Fan System Check (DC Motor)

Check No.05

Check No.23
 Refer to P.150

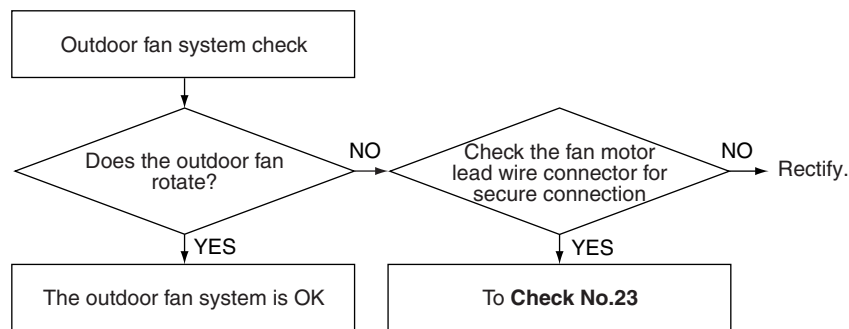

(R9460)

3.4 Power Supply Waveform Check

Check No.08

Check the voltage waveform between power supply terminals on the terminal board for disturbance using oscillo-tester.

- Check to see if the power supply waveform is a sine wave (Fig.1).
- Check to see if there is waveform disturbance near the zero cross (sections circled in Fig.2)

[Fig.1]

[Fig.2]

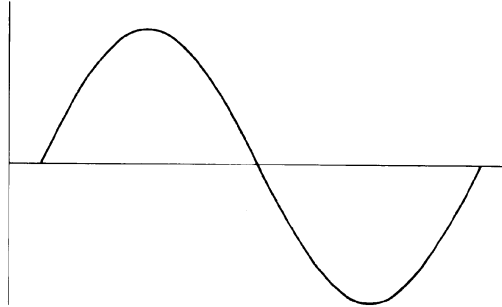

(R1736)

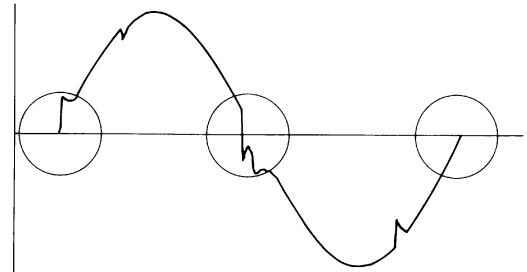

(R1444)

3.5 Main Circuit Electrolytic Capacitor Check

Check No.11

- Do not touch the live parts within 10 minutes after the breaker is turned off.
- Even after that, when you touch the parts, check that there is no DC voltage with a tester.
- Check the conductivity with a tester. It is OK if the tester shows good conductivity when pins are replaced.

Set the tester to the resistance measuring range

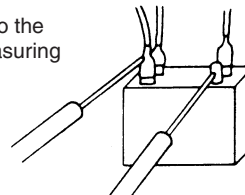

If the pointer swings and returns, the electrolytic capacitor is OK.

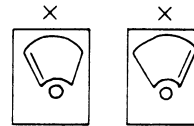

If the pointer does not swing, or does not return, the electrolytic capacitor is out of order.

(R3466)

3.6 Refrigerant System Check

Check No.12

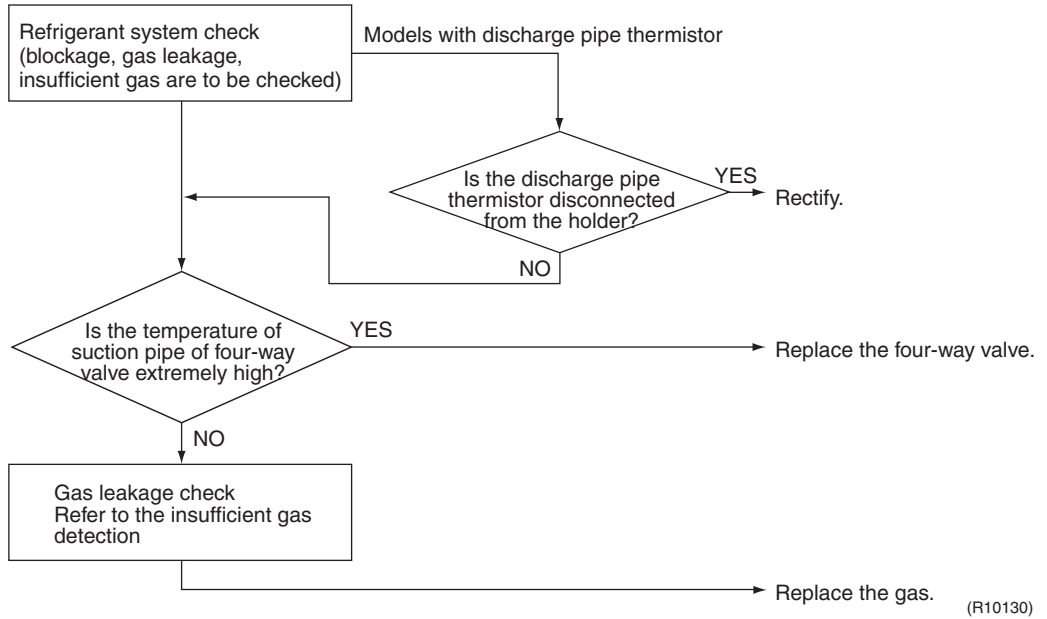

3.7 “Inverter Checker” Check

Check No.14

1. Characteristics

If abnormal stop occurs due to compressor startup failure or overcurrent output when using inverter unit, it is difficult to judge it results from the compressor failure or other failure (control PCB, power transistor, etc.). The inverter analyzer makes it possible to judge the cause of trouble easily and securely. (Connect this analyzer as a quasi-compressor instead of compressor and check the output of inverter)

2. Operation Method

- 1) Be sure to turn the power off.
- 2) Install the inverter analyzer instead of a compressor.

Note: Make sure the charged voltage of the built-in smoothing electrolytic capacitor drops to 10 VDC or below before carrying out the service work.

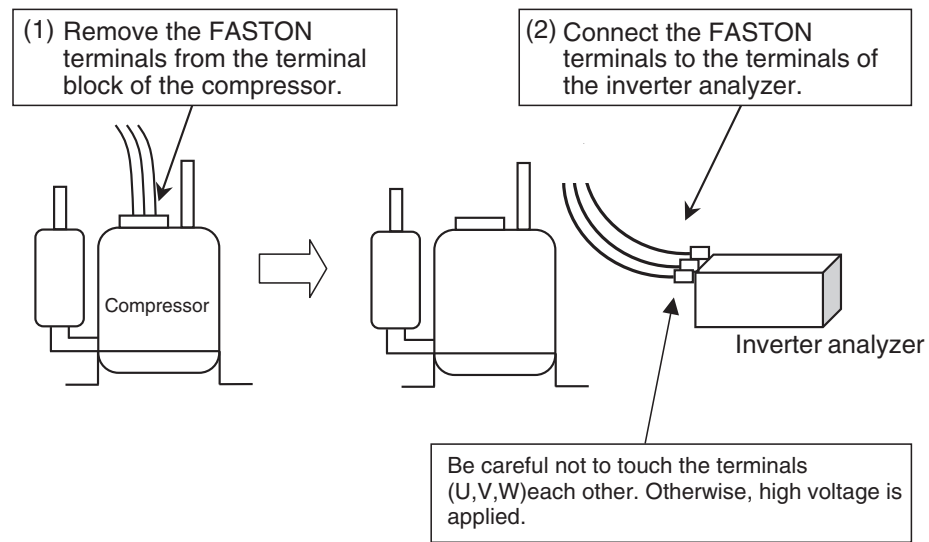

Reference

If the connector terminal of compressor is not a FASTON terminal (difficult to remove the wire on the terminal), it is possible to connect a wire available on site to the unit from output side of PCB. (Do not connect it to the compressor at the same time, otherwise it may result in incorrect detection.)

- 3) Turn the power on and operate the air conditioner.

■ How to activate the inverter test mode

- 1) Turn the power on.
- 2) Hold the “CLOCK” button for 5 seconds.
(The matrix display will appear on the remote controller.)
- 3) Display “” on the matrix display of the remote controller and press the “CLOCK” button.
- 4) “?” will be displayed.
- 5) Press the “CLEAN” button to start inverter test.

3. Diagnose method (Diagnose can be made according to 6 LEDs lighting status as follows:)

- (1) When all LEDs are lit uniformly, → Compressor malfunction (to be replaced)
 - (2) When some of LEDs are not lit (LEDs are not lit or go off, etc.):
 Check the individual power transistor. (Refer to check No.15)
 - * When the power transistor and control PCB are integrated :
 → Replace the control PCB.
 - * When the power transistor can be checked individually :
 ↓ Check the resistance value. (Refer to check No.15)
- If NG : → The power transistor may have a failure. (Replace the power transistor).
 If the power transistor is normal, check if there is any solder cracking on filter PCB.
- * If any solder cracking is found: → Replace the filter PCB (or repair the soldered section).
 - * If filter PCB is normal: → Replace the control PCB.

Caution

- ① When the output frequency is low, the LED flashes slowly. As the frequency increases, the LED flashes quickly. (It looks like the LED is lit)
- ② If the operation is carried out with no load (the condition of the compressor is disconnected), some of units may stop operation with “CT system error” (due to no electric current) or “startup failure” (because the compressor does not turn). In this case, check if the LED is flashing during “operation” to “malfunction stop”. (Refer to the service manual of each air conditioner for checking whether the alarm LEDs for CT system, startup failure, etc. are provided or not.)
- ③ On completion of diagnose by this checker, be sure to re-crimp the FASTON terminal for resetting the system.
 (Otherwise, the terminal may be burned due to loosening.)

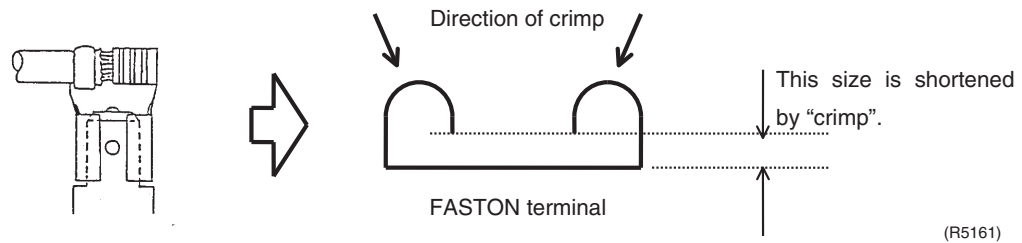

3.8 Power Transistor Check

Check No.15

- Do not touch the live parts within 10 min. after the breaker is turned off.
- Even after that, when you touch the parts, check to see that supply voltage of the power transistor is less than 50 V with a tester.
- Measure resistance at connector terminal on PCB or at the relay connector.

(-) terminal of a tester	Power transistor (+)	UVW	Power transistor (-)	UVW
(+) terminal of a tester	UVW	Power transistor (+)	UVW	Power transistor (-)
Resistance in OK	several kΩ~several MΩ			
Resistance in NG	0 or ∞			

3.9 Discharge Pressure Check

Check No.16

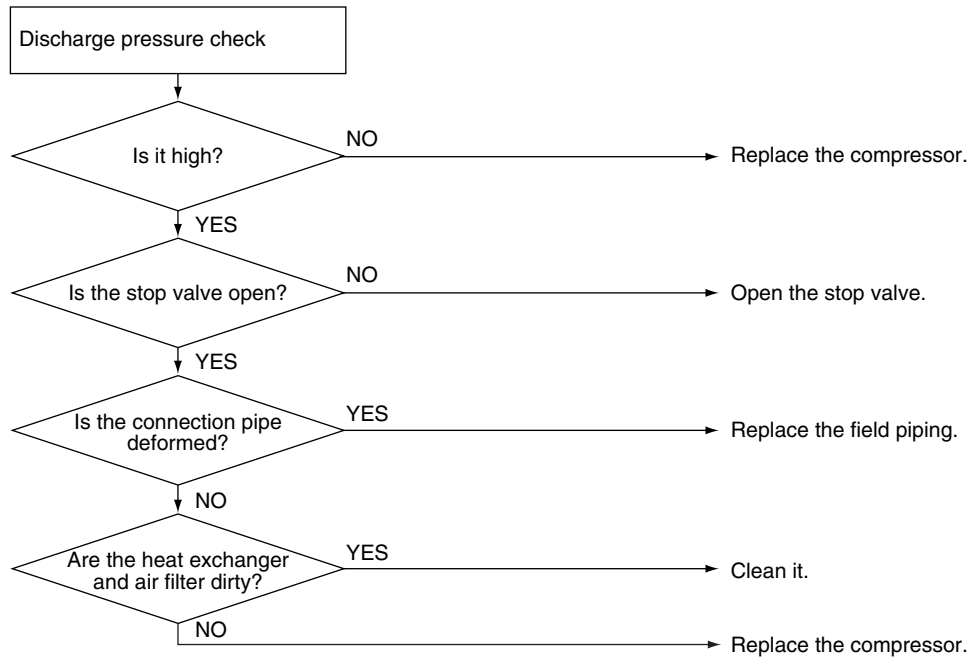

(R9683)

3.10 Electronic Expansion Valve Check

Check No.17

Check the electronic expansion valve (EV) as follows:

1. Check if the EV connector is properly inserted into the control PCB. Collate the number of EVs in the main body with those of the connector.
2. Check to see if clicking (latching sound) is heard from all of the EVs when turning on the power supply again after turning it off.
3. If there are EVs which do not click, disconnect the connectors of these EVs and check them for conductivity.

Harness: 6 wires

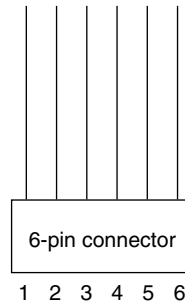

Check {
 5 - 2
 5 - 4
 6 - 1
 6 - 3

(R6028)

4. If there are no clicks (latching sounds) on all of the EVs in step 2, the outdoor PCB is defective.
5. For EVs for which conductivity is established in step 3, connect the coil that made the latching sound to the EV main body which did not make the sound, and test to see if the latching sound occurs.

If latching sound is heard, the outdoor unit PCB is defective.

If there is no latching sound, the EV main body is defective.



Note Latching sounds vary with different valves.

3.11 Indoor Unit PCB Output Check

Check No.18

<Control PCB (A1P)>

1. Check for proper connection.
2. Check supply voltage applied to the motor output (between No. 4 pin and No. 7 pin).
3. Check motor control voltage output (between No. 3 pin and No. 4 pin).
Check rpm command voltage output (between No. 2 pin and No. 4 pin).

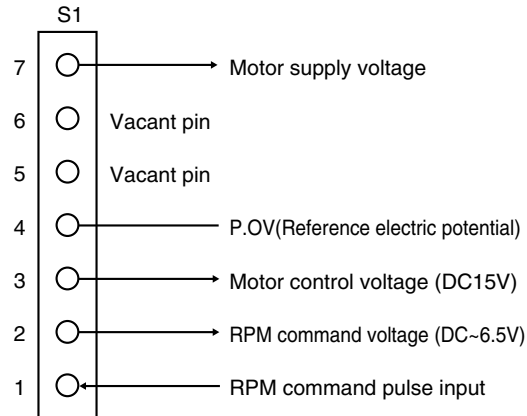

(R4023)

3.12 Rotating Pulse Input on Outdoor Unit PCB Check

Check No.23

< For propeller fan motor >

Make sure voltage of 270 ± 30 V is applied.

1. Set power ON and operation OFF. Remove connector S70.
2. Check that the voltage between No. 4 pin and No.7 pin is 270 VDC.
3. Check that the control voltage between No. 3 pin and No. 4 pin is 15 VDC.
4. Check that the RPM command voltage between No. 2 pin and No. 4 pin is 5 VDC.
5. Set power OFF and operation OFF. Connect connector S70.
6. Check whether two pulses (0 - 15 V) are input at No. 1 pin and No. 4 pin when the fan motor is rotated 1 turn by hand.

Fuses are commonly used as follows. Refer to the corresponding circuit diagram.

FU1	SW power supply Four way valve
FU2	Outdoor fan

When FU2 is melted, check outdoor fan for proper function.

If NG in step 2 → Defective PCB → Replace the PCB.

If NG in step 4 → Defective Hall IC → Replace the DC fan motor.

If OK in both steps 2 and 4 → Replace the PCB.

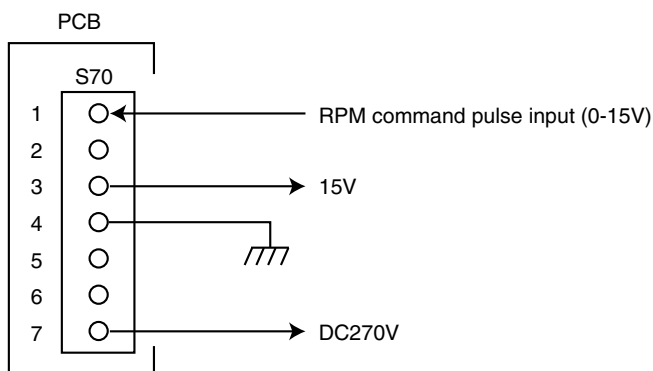

(R3477)

- Propeller fan motor: S70

3.13 Humidity Sensor Check

Check No.27

1. Check for proper connection.
 2. Check sensor input level (*1).
 3. Change ambient conditions (*2) and check that input level changes accordingly.
- *1 Input level varies depending on the sensor.
 *2 Changes in humidity, temperature, airflow rate. To do this, merely breathe on the sensor.

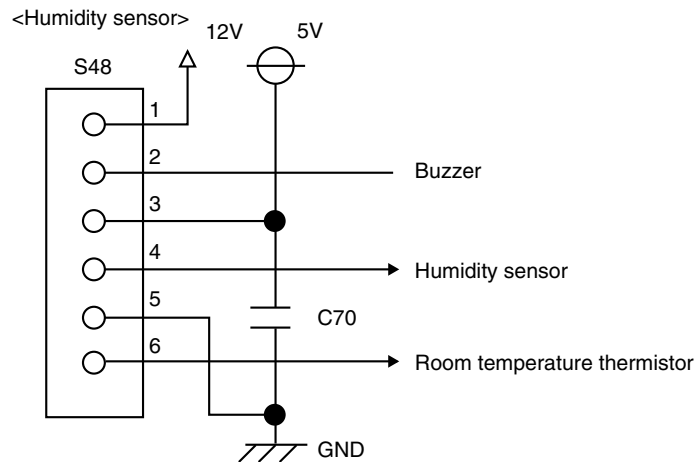

(R6023)

3.14 Main Circuit Short Check

Check No.29

- Measure the resistance between pins at both ends of DB1.
- If the resistance is ∞ or less than 1 k Ω , the main circuit short.

(-) terminal of the tester (in case of digital, (+) terminal)	(~)	(+)	(~)	(-)
(+) terminal of the tester (in case of digital, (-) terminal)	(+)	(~)	(-)	(~)
Resistance in OK	several k Ω ~several M Ω	∞	∞	several k Ω ~several M Ω
Resistance in NG	0 or ∞	0	0	0 or ∞

3.15 Four-Way Valve Performance Check

Check No.31

< Caution on resetting the power supply >
 * Be sure to wait for 30 sec. or more after turning off the power supply.

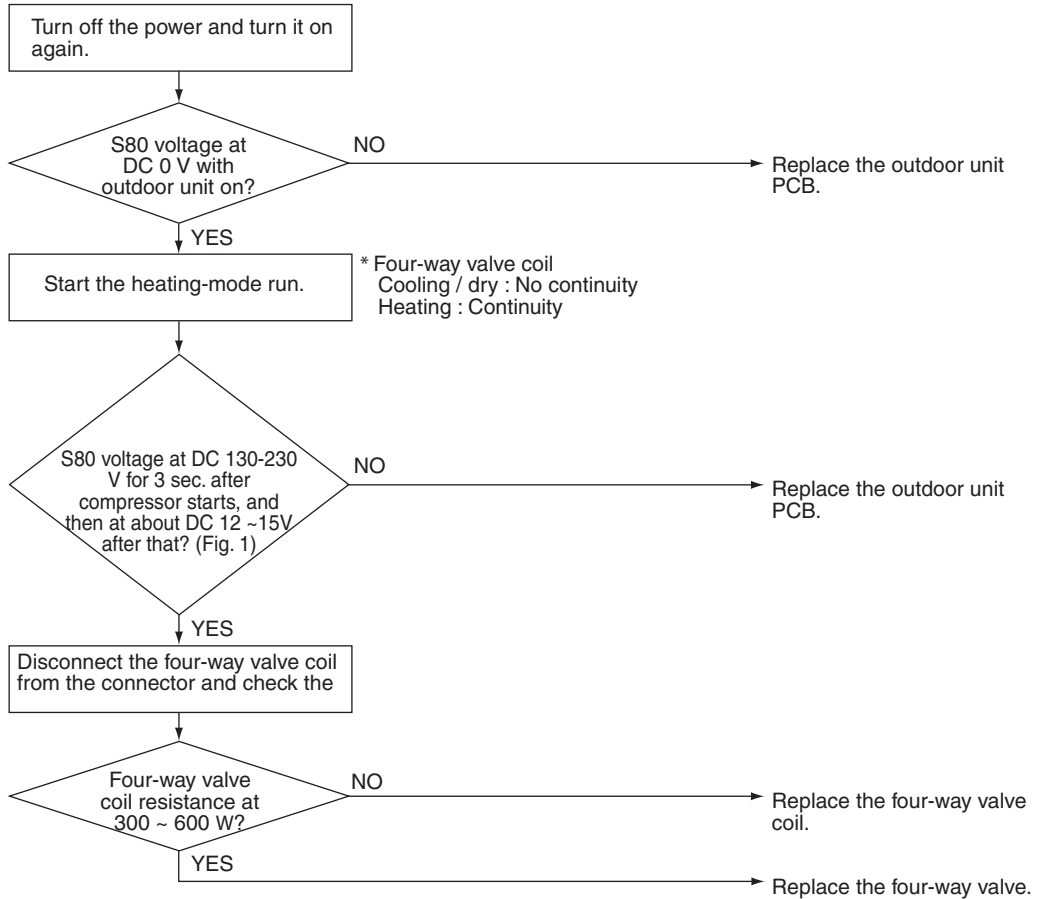

(Fig. 1)

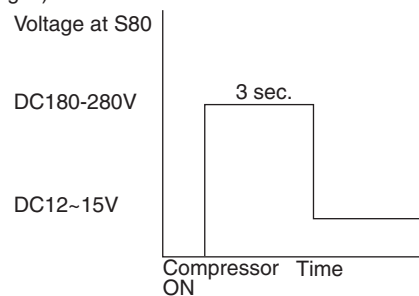

(R9462)

3.16 Solenoid Valve for Dehumidification Check

Check No.32

Faulty criterion:

In dehumidification test operation mode, PCB is identified as a faulty when the solenoid valve does not turn on within 2 seconds after compressor start-up. (When reheating dehumidifying is not used, the operation mode is similar to cooling operation.)

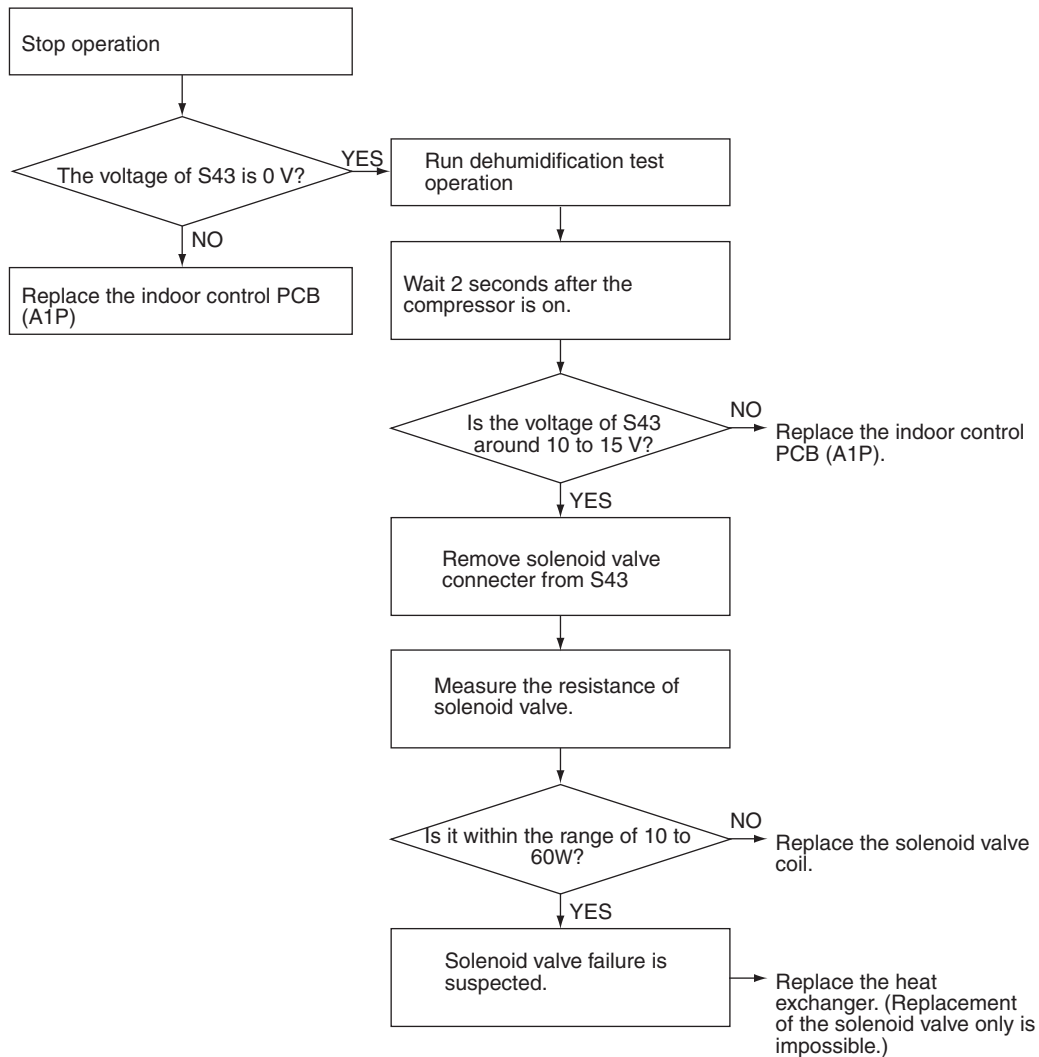

(R10131)

Part 7

Removal Procedure

1. Indoor Unit.....	156
1.1 Removal of Air Filters / Front panel.....	156
1.2 Removal of Upper Panel	163
1.3 Removal of Front Grille	166
1.4 Removal of Assembly of Open/Close Mechanism	169
1.5 Removal of Assembly of Reduction Motor	171
1.6 Removal of Electrical Box	174
1.7 Removal of PCB.....	179
1.8 Removal of Dehumidifying Solenoid Valve Coil	185
1.9 Removal of Drain Hose	186
1.10 Removal of Swing Motor	189
1.11 Removal of Heat Exchanger	190
1.12 Removal of Propeller Fan / Fan Motor	193
1.13 Removal of Horizontal Blades / Vertical Blades	196
1.14 Removal of Streamer Unit.....	199
2. Outdoor Unit.....	203
2.1 How to Check the Service Monitor (LED A)	203
2.2 Removal of Propeller Fan / Fan Motor	205
2.3 Removal of Electrical Box	210
2.4 Removal of PCB.....	214
2.5 Removal of Sound Blanket.....	218
2.6 Removal of Thermistor Assembly	220
2.7 Removal of Reactor / Partition Plate	222
2.8 Removal of Four-Way Valve	224
2.9 Removal of the Expansion Valve	226
2.10 Removal of Compressor.....	228

1. Indoor Unit

1.1 Removal of Air Filters / Front panel

Procedure

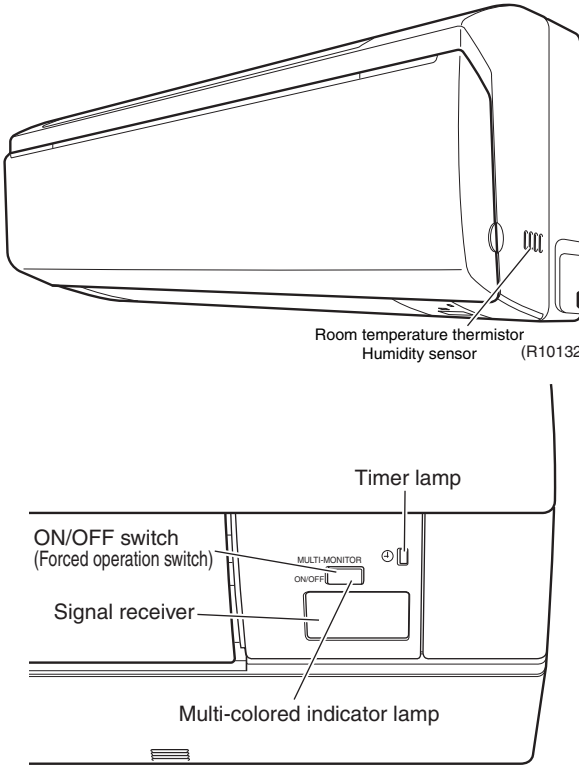
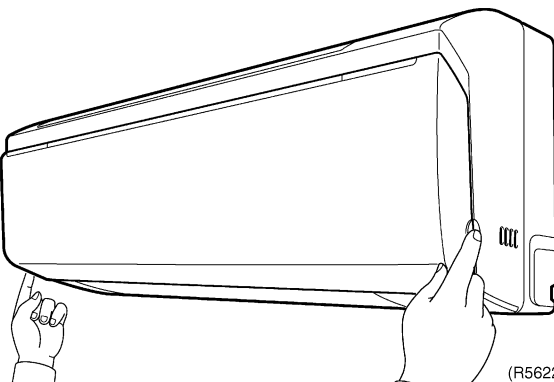

Warning Be sure to wait 10 minutes or more after turning off all power supplies before disassembling work.

Step	Procedure	Points
<p>1. External appearance</p>		<ul style="list-style-type: none"> ■ Multi-colored indicator lamp changes its color according to the operation mode. HEATING : Red COOLING : Green QUATERNITY DRYING/DRY COOLING : Yellow FLASH STREAMER AIR PURIFYING : White ■ Remote controller is interactive communication type.
<p>2. Removal of the air filter</p>	<p>1 Hold the front panel on both sides and lift it up.</p> 	

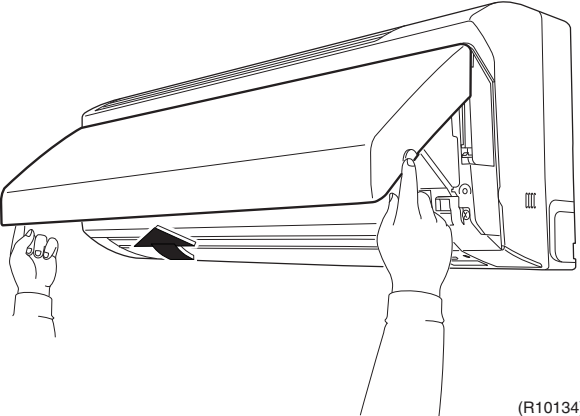
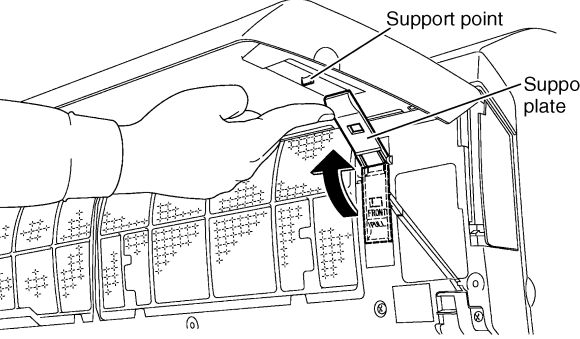
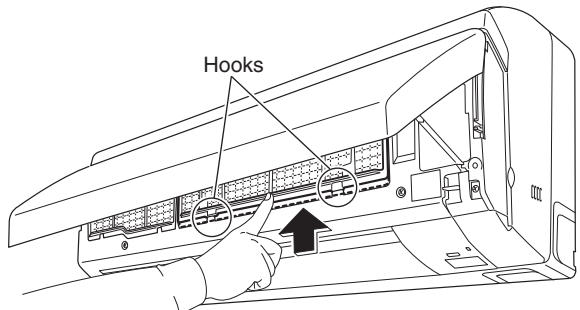
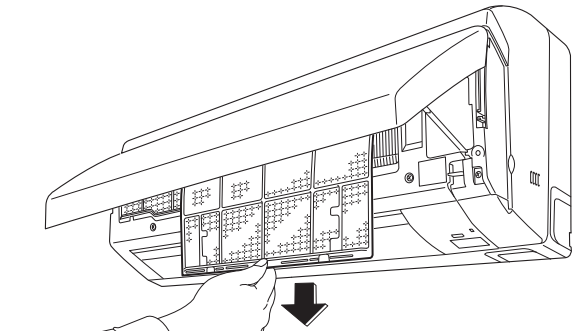
Step		Procedure	Points
2	Keep the front panel open with the support plate.	 <p>(R10134)</p>  <p>(R5624)</p>	
3	Push the center part of the air filter up to undo the 2 hooks.	 <p>(R10135)</p>	
4	Remove the air filter toward yourself.	 <p>(R10136)</p>	

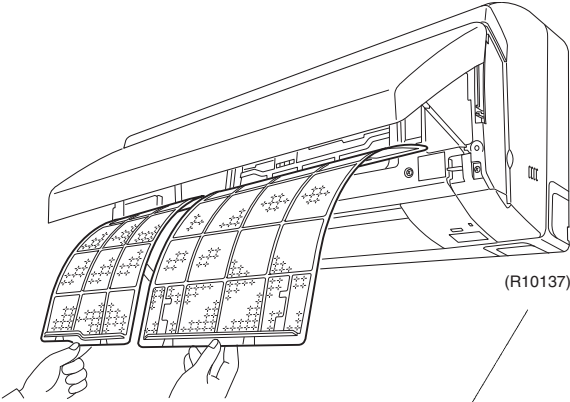
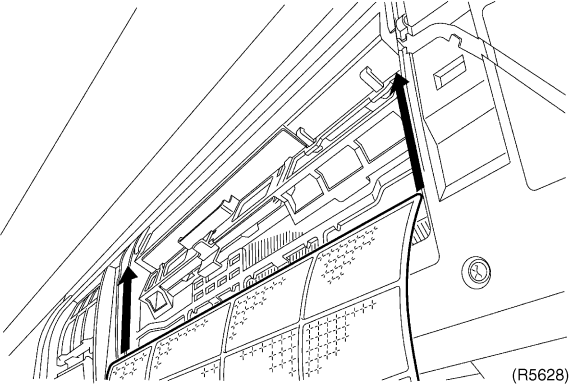
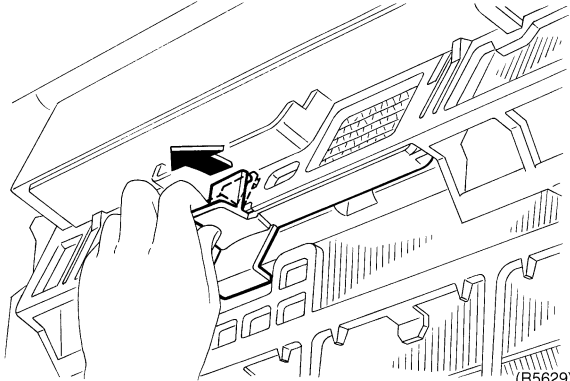
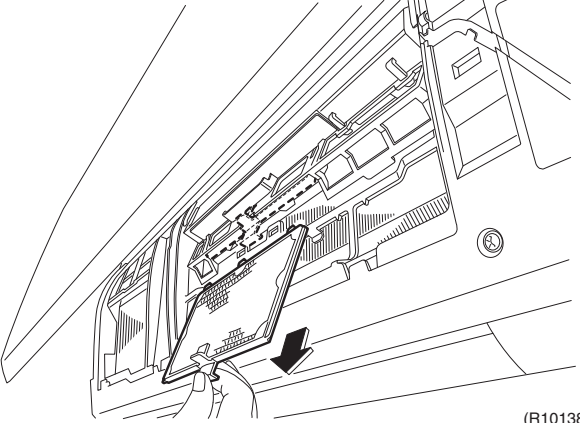
Step	Procedure	Procedure	Points
5	The shapes of the right and left filters are different.	 <p>(R10137)</p>  <p>(R5628)</p>	<p>■ Insert the filters along with the guide for easy installation.</p>
3. Remove the deodorizing filter for streamer		 <p>(R5629)</p>	
1	Pull the center knob to undo the hook.		
2	Pull out the deodorizing filter for streamer toward yourself.	 <p>(R10138)</p>	

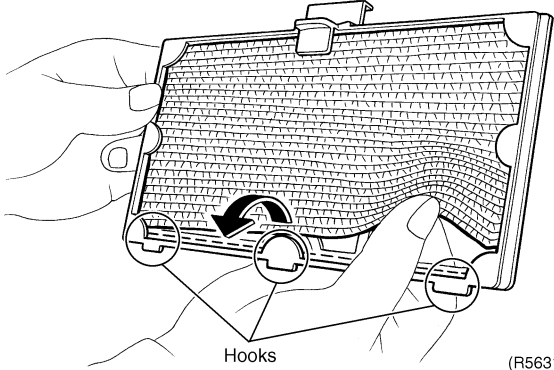
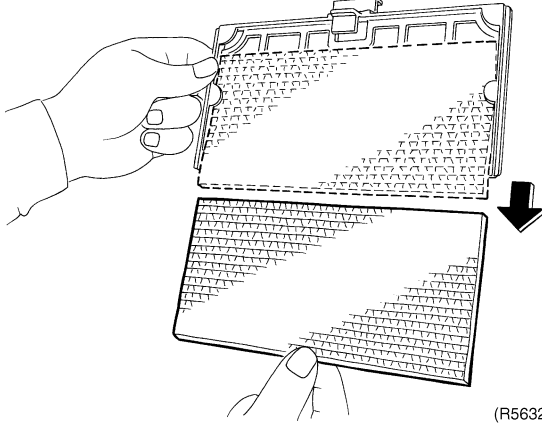
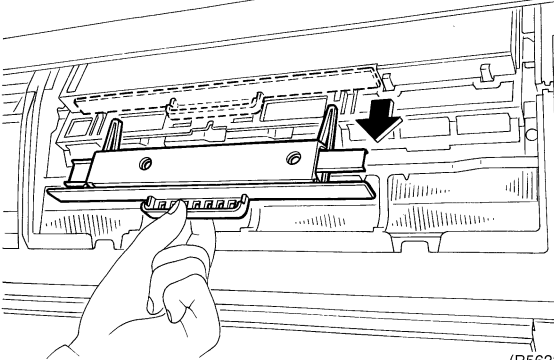
Step	Procedure	Procedure	Points
3	Undo the 3 hooks on the longitudinal direction.	 <p style="text-align: center;">Hooks (R5631)</p>	<ul style="list-style-type: none"> ■ In cleaning, keep the filter with the frame to prevent breaking it..
4	Slide the filter toward yourself to remove.	 <p style="text-align: center;">(R5632)</p>	
4. Removal of the streamer unit			
1	Pull down the streamer unit with holding the knob.	 <p style="text-align: center;">(R5633)</p>	

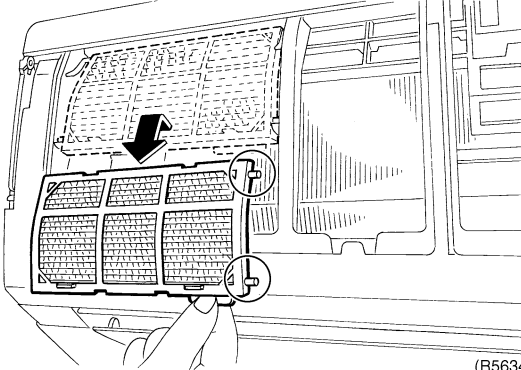
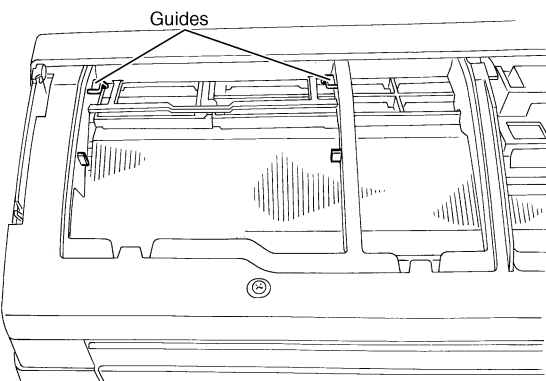
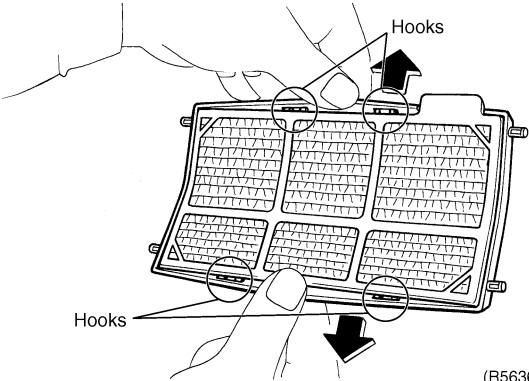
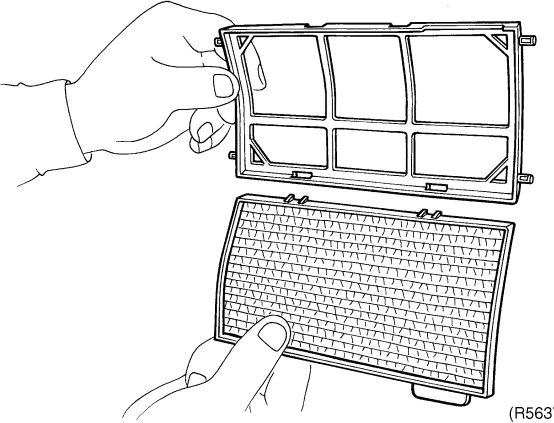
Step	Procedure	Points
5.	Removal of the titanium apatite photocatalytic air-purifying filter	
1	<p data-bbox="203 317 495 443">Undo the projection of the frame of titanium apatite photocatalytic air-purifying filter and remove it.</p>  <p data-bbox="1031 583 1088 609">(R5634)</p>  <p data-bbox="1031 1018 1088 1043">(R0070)</p> <p data-bbox="1144 646 1485 714">■ Insert the filters along with the guide for easy installation.</p>	
2	<p data-bbox="203 1056 495 1213">Undo the 4 hooks, open the frame, and remove the titanium apatite photocatalytic air-purifying filter.</p>  <p data-bbox="1031 1423 1088 1449">(R5636)</p>  <p data-bbox="1031 1879 1088 1904">(R5637)</p>	

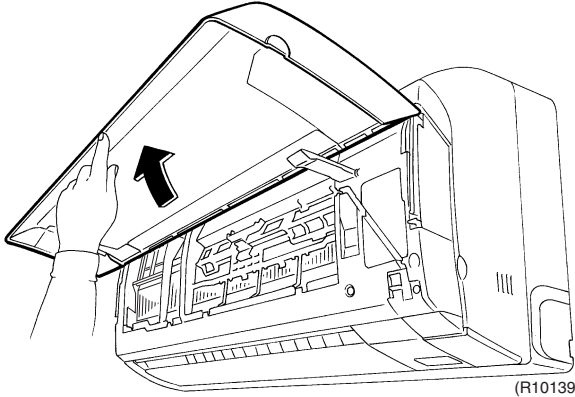
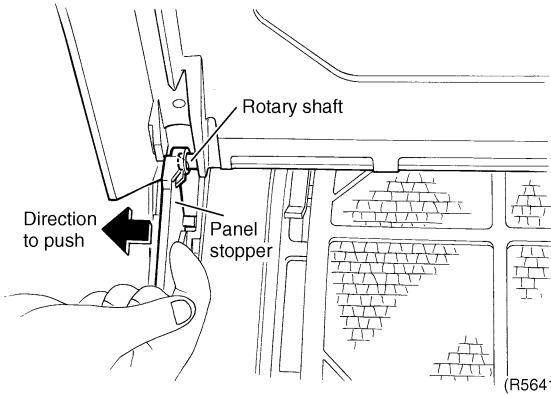
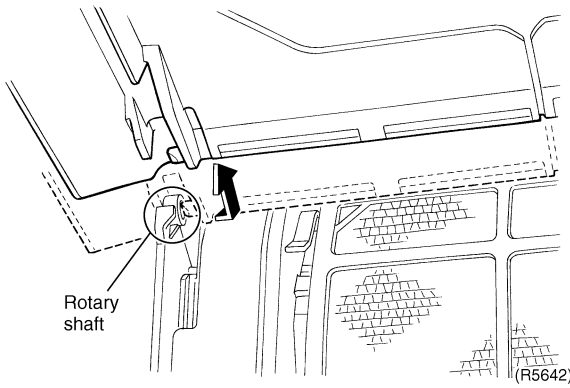
Step	Procedure	Points
6. Removal of the front panel	<p data-bbox="152 247 480 342">1 Open the front panel further than the stopping position.</p>  <p data-bbox="152 678 493 835">2 Push the panel stoppers outward on both right and left sides to detach the rotary shafts from the holes.</p>  <p data-bbox="152 1144 493 1239">3 Slide the rotary shaft on the left to the right and pull it out toward yourself.</p> 	

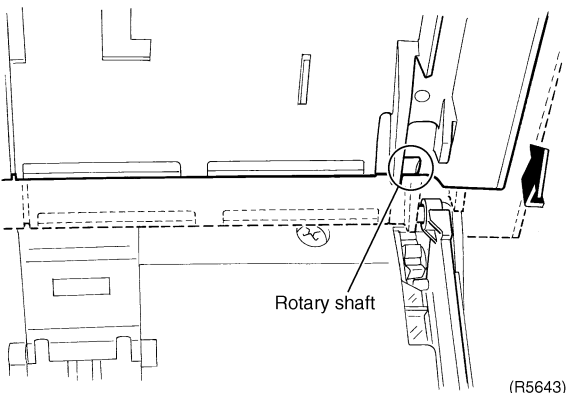
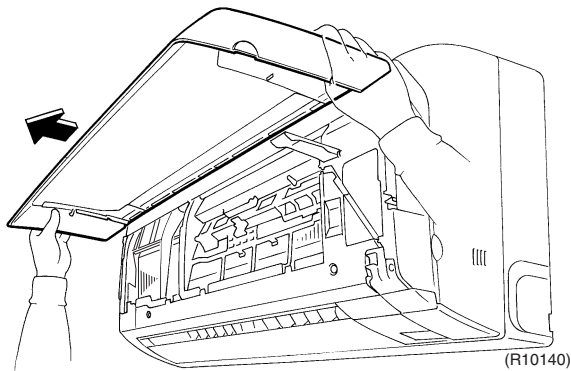
Step	Procedure	Points
4	<p>Slide the rotary shaft on the right to the left and pull it out toward yourself.</p>  <p style="text-align: right;">(R5643)</p>	
5	<p>Remove the front panel.</p>  <p style="text-align: right;">(R10140)</p>	

1.2 Removal of Upper Panel

Procedure

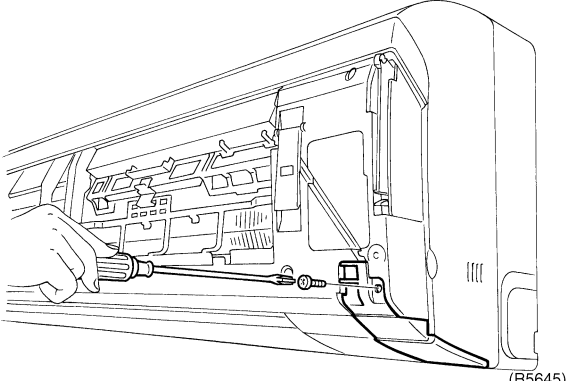
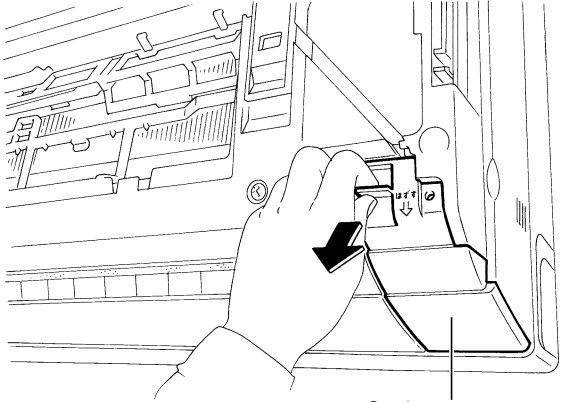
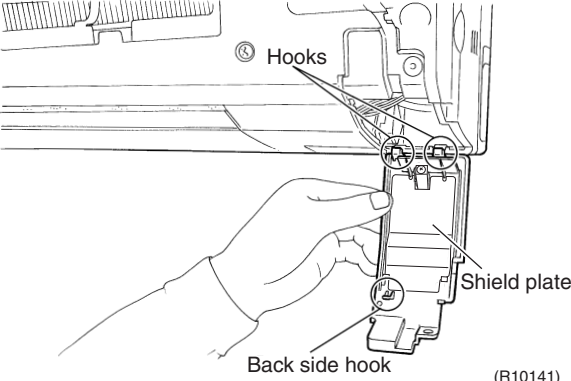

Warning Be sure to wait 10 minutes or more after turning off all power supplies before disassembling work.

Step	Procedure	Points
1. Removal of the service cover		
1	<p>Remove the 1 screw (black) of the service cover.</p>  <p style="text-align: right;">(R5645)</p>	
2	<p>Slide the service cover downward to undo the hook on the back side (see the figure below).</p>  <p style="text-align: right;">Service cover (R5646)</p>	
3	<p>When assembling, catch the 2 hooks on the far side first, and close the cover.</p>  <p style="text-align: right;">Hooks Shield plate Back side hook (R10141)</p>	

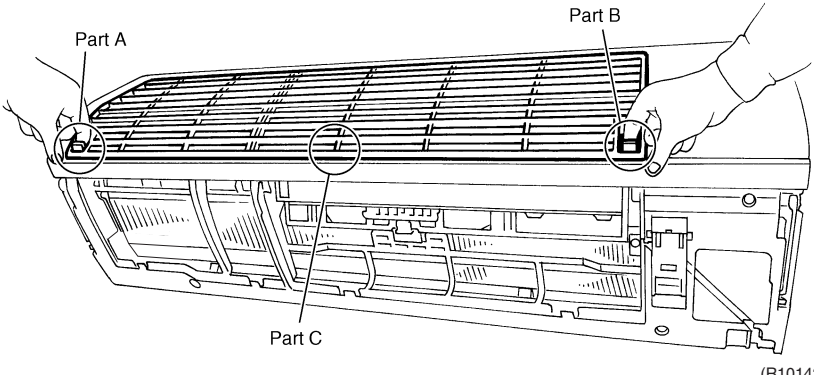
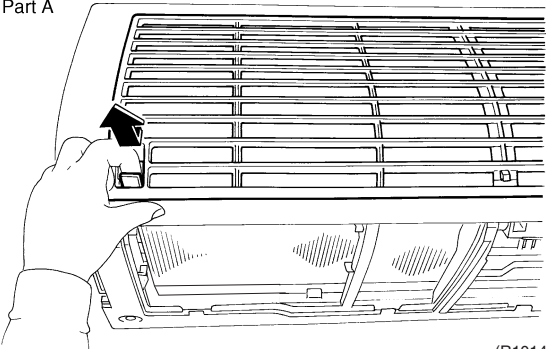
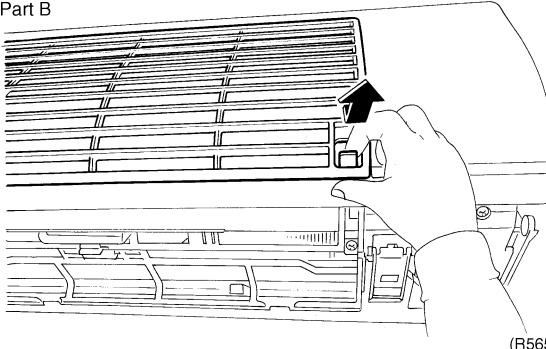
Step	Procedure	Points
<p>2. Removal of the upper panel</p> <p>1</p> <p>2</p> <p>3</p>	<p>Release the 3 hooks of the upper panel.</p> <p>In part A, pinch the upper hook, release the hook, and lift it up.</p> <p>In part B, release the hook as in part A, and lift it up.</p>   	

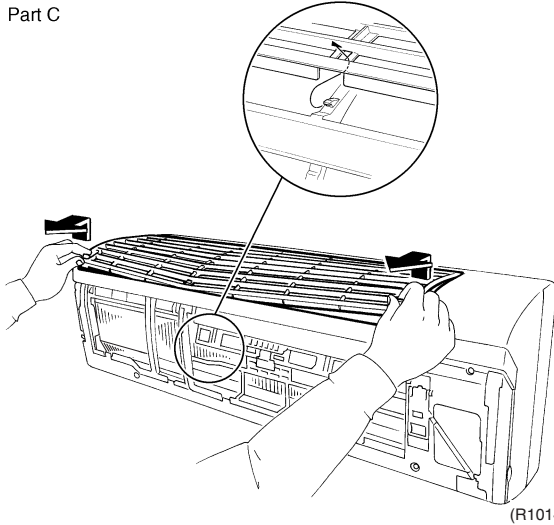
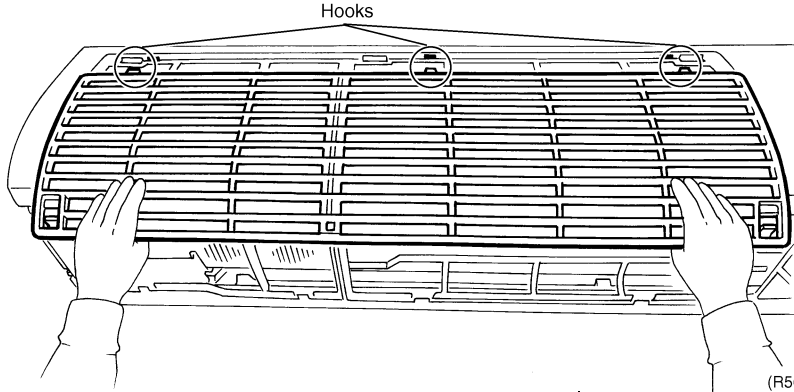
Step	Procedure	Points
4	<p>In part C, lift the right and left sides to bend the upper panel and slightly pull toward yourself to remove.</p> 	
5	<p>Pull the upper panel toward yourself to remove.</p> 	<p>■ When assembling, make sure to catch the far side hooks.</p>

1.3 Removal of Front Grille

Procedure

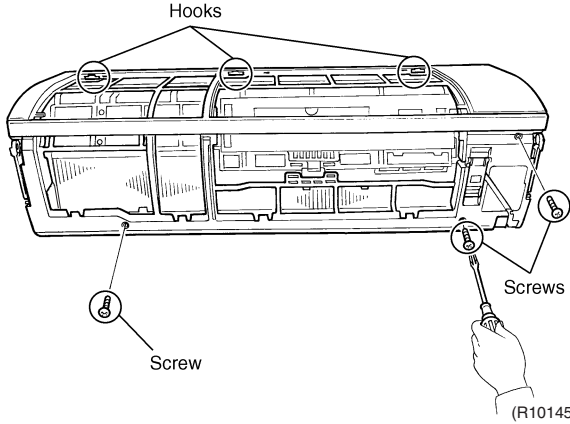
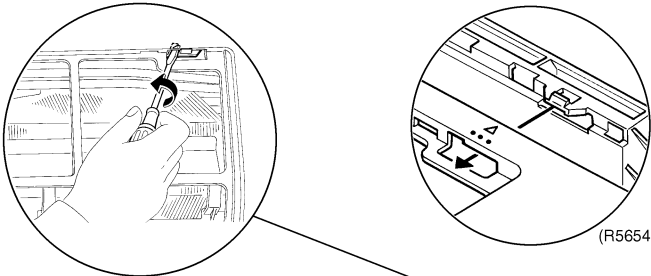
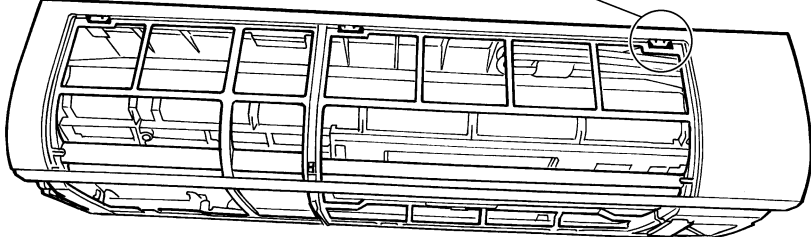
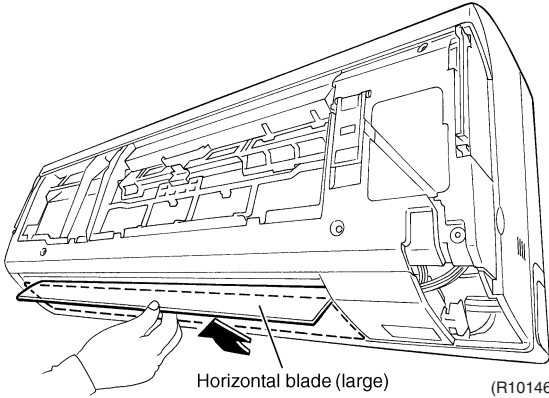

Warning Be sure to wait 10 minutes or more after turning off all power supplies before disassembling work.

Step	Procedure	Points
1. Removal of the front grille		
1	<p>Remove the 3 screws and undo the upper 3 hooks of the front grille.</p>   	<ul style="list-style-type: none"> ■ If the hooks are hard to be undone, use a flat screwdriver. ■ You can check the position by the projection when it is hard to see.
2	<p>Open the horizontal blade (large) fully for preventing the blade from getting caught in pulling the front grille out.</p> 	

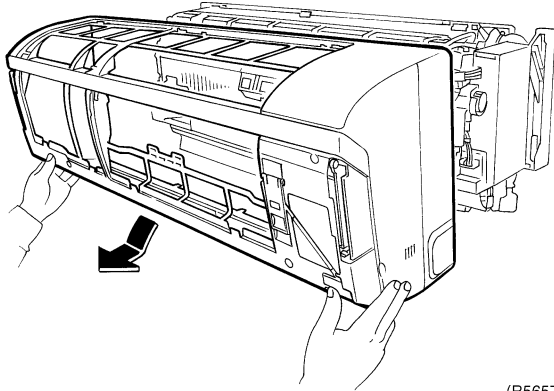
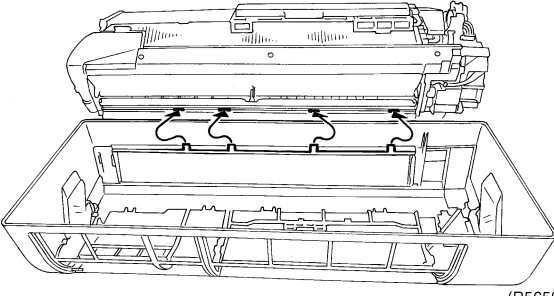
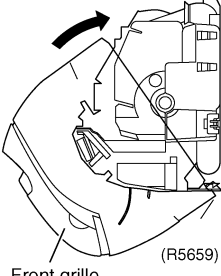
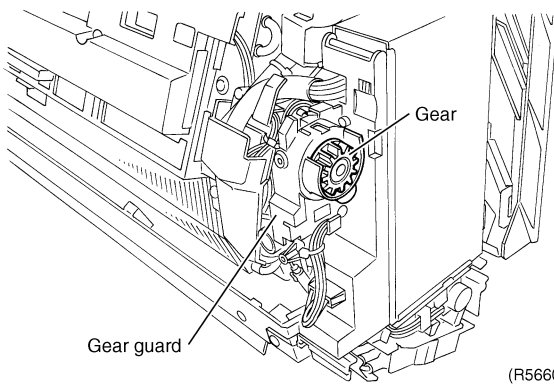
Step		Procedure	Points
3	Slide the front grille toward yourself to remove.	 <p>(R5657)</p>	
2. How to install the front grille		 <p>(R5658)</p>	<p>Points on installing</p> <ul style="list-style-type: none"> ■ When assembling, make sure that the horizontal blade (large) does not come inside. ■ When assembling, follow the same steps for removal in reverse.  <p>Front grille (R5659)</p>
3. Features of the gear case		 <p>Gear Gear guard</p> <p>(R5660)</p>	<ul style="list-style-type: none"> ■ There is no mark for fitting the gear.

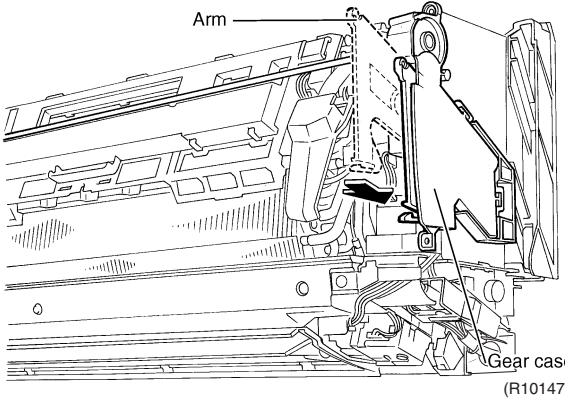
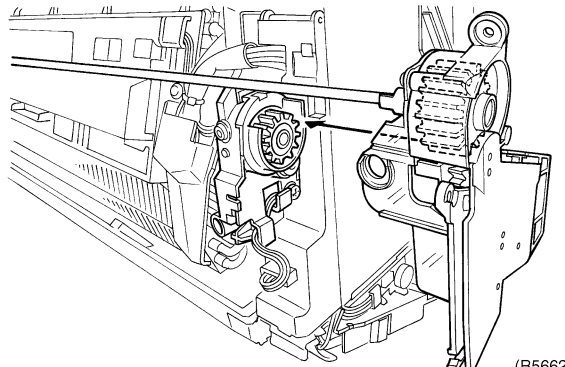
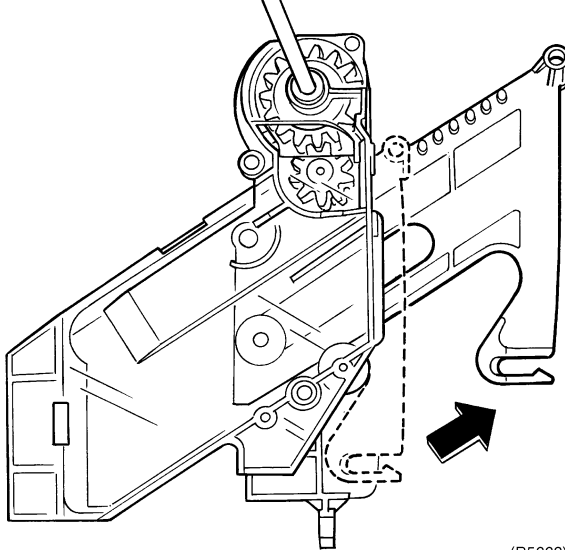
Step		Procedure	Points
2	<p>Check that the arm in the gear case of the front grille is in the stored position.</p>	 <p style="text-align: right;">(R10147)</p>	<ul style="list-style-type: none"> ■ The gear case is fixed to the front grille. When assembling the front grille, make sure the arm is stored.
3	<p>Installation structure of the gear case.</p>	 <p style="text-align: right;">(R5662)</p>	
4	<p>Movement of the arm.</p>	 <p style="text-align: right;">(R5663)</p>	

1.4 Removal of Assembly of Open/Close Mechanism

Procedure

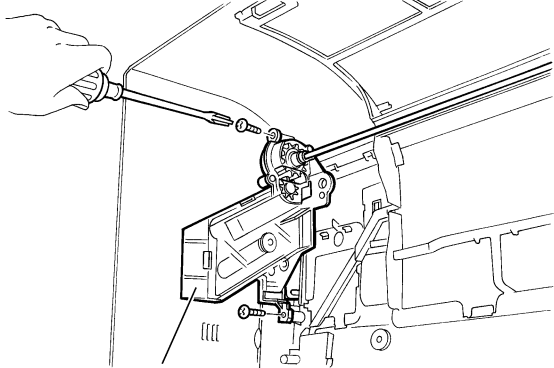
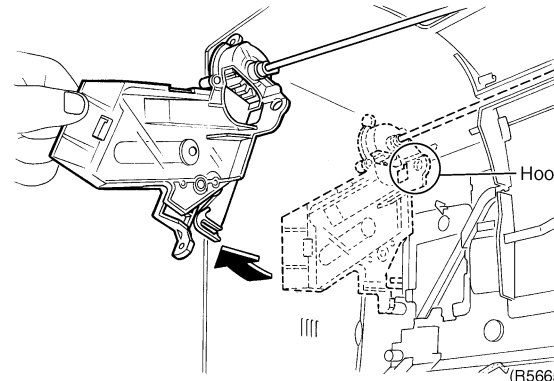
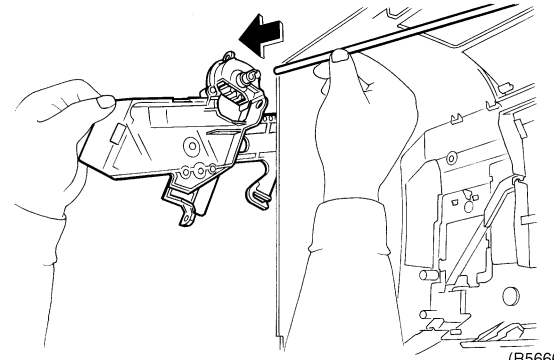

Warning Be sure to wait 10 minutes or more after turning off all power supplies before disassembling work.

Step	Procedure	Points
1. Removal of the open/close mechanism (right)		<p>Preparation</p> <ul style="list-style-type: none"> ■ Remove the front grille according to "Removal of the Front Grille". ■ When assembling, catch the lower hook first.
1 Remove the 1 screw of the open/close mechanism (right).	 <p>Open/close mechanism (right) (R5664)</p>	
2 Remove the lower hook while straightening the open / close mechanism (right) and remove it.	 <p>Hook (R5665)</p>	
3 Pull out the open/close mechanism (right) from the shaft.	 <p>(R5666)</p>	

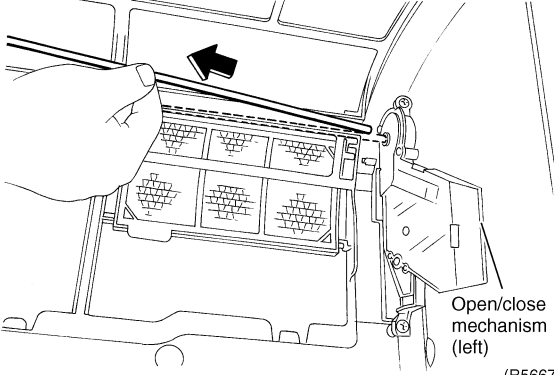
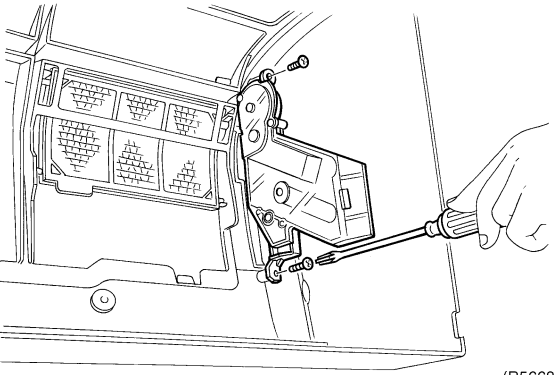
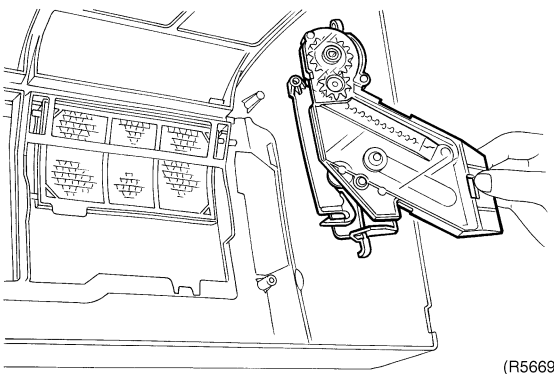
Step	Procedure	Points
2. Removal of the open/close mechanism (left)		
1	<p>Pull out the shaft from the open/close mechanism (left).</p>  <p style="text-align: right;">(R5667)</p>	
2	<p>Remove the 2 screws of the open/close mechanism (left).</p>  <p style="text-align: right;">(R5668)</p>	<p>■ Service part is obtained as an assembly kit.</p>
3	<p>Remove the open/close mechanism (left).</p>  <p style="text-align: right;">(R5669)</p>	

1.5 Removal of Assembly of Reduction Motor

Procedure

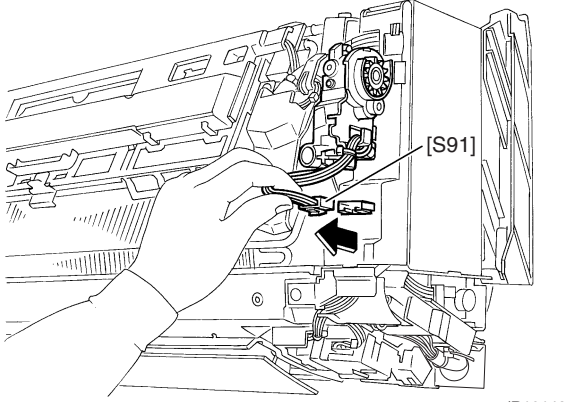
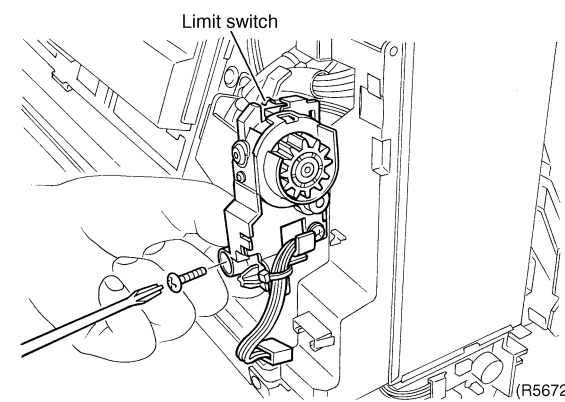
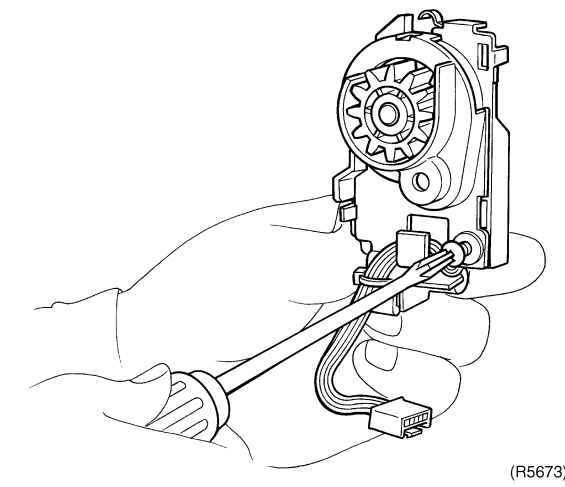
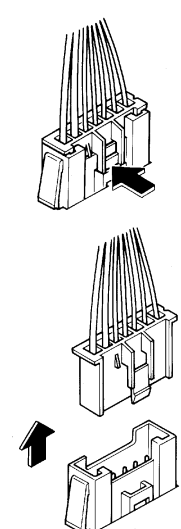

Warning Be sure to wait 10 minutes or more after turning off all power supplies before disassembling work.

Step	Procedure	Points
1. Removal of the assembly of the reduction motor		
1	Disconnect the connector for reduction motor [S91] (S51).	 <p style="text-align: right;">(R10148)</p>  <p style="text-align: right;">(R5672)</p>
2	Remove the 1 screw of the assembly of the reduction motor.	 <p style="text-align: right;">(R5673)</p>
2. Removal of the reduction motor	1 Remove the 1 screw.	 <p style="text-align: right;">(R5671)</p> <ul style="list-style-type: none"> ■ The figure above shows the hook on the connector for the assembly of reduction motor. ■ When touching the electrical parts like the limit switch, be sure to conduct the work after discharging static electricity of the human body as it can cause problems with the PCB.

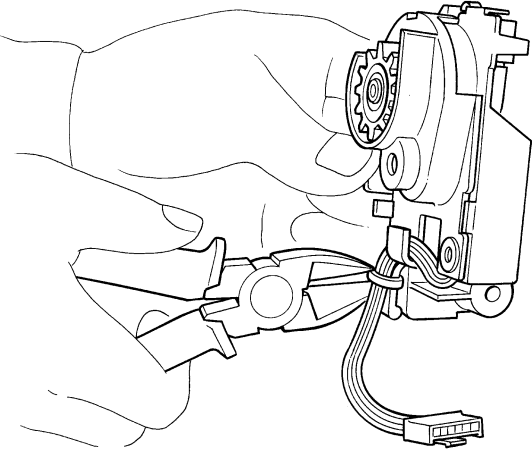
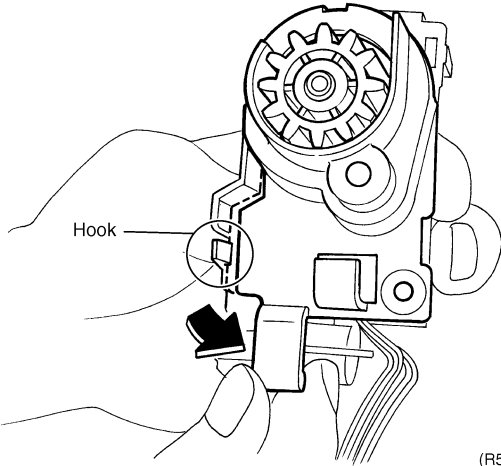
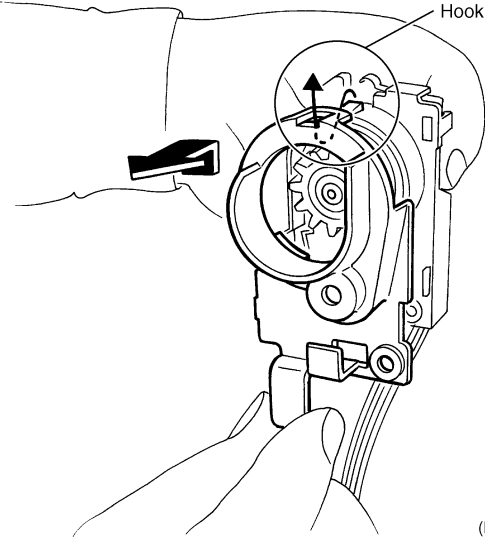
Step	Procedure	Points	Points
2	Cut the clamp.	 <p>(R5674)</p>	
3	Slide the cover to the right to undo the hook.	 <p>(R5675)</p>	
4	Lift the cover of the gear case of the reduction motor up slightly to undo the upper hook, and remove it.	 <p>(R5676)</p>	

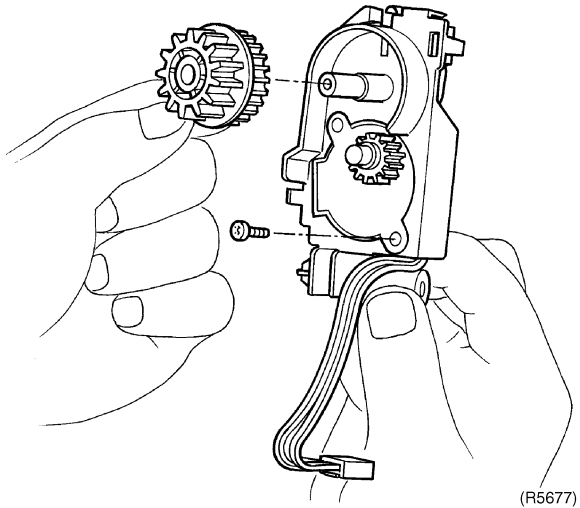
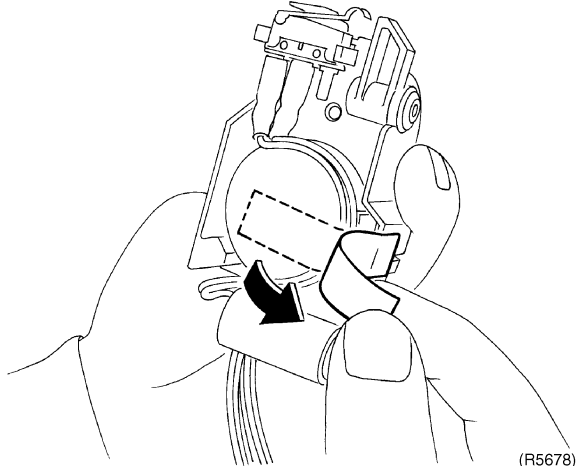
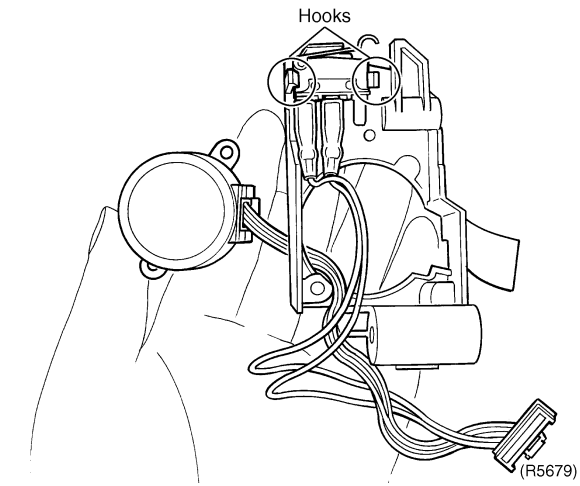
Step	Procedure	Procedure	Points
5	Pull the gear out to remove. Remove the 1 screw of the reduction motor.	 <p>(R5677)</p>	
6	Turn the assembly over and detach the sealing tape of the reduction motor.	 <p>(R5678)</p>	
7	Release the 2 hooks of the limit switch.	 <p>(R5679)</p>	<ul style="list-style-type: none"> ■ The connector of the reduction motor can be disconnected.

1.6 Removal of Electrical Box

Procedure

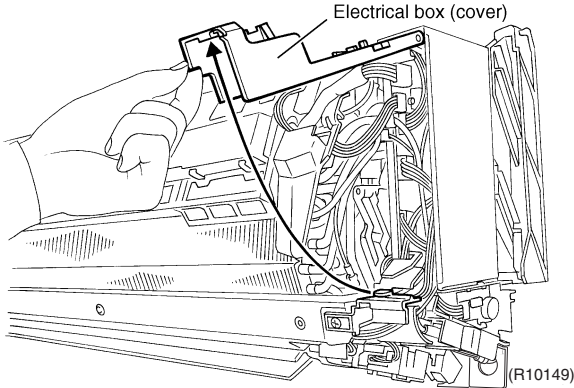
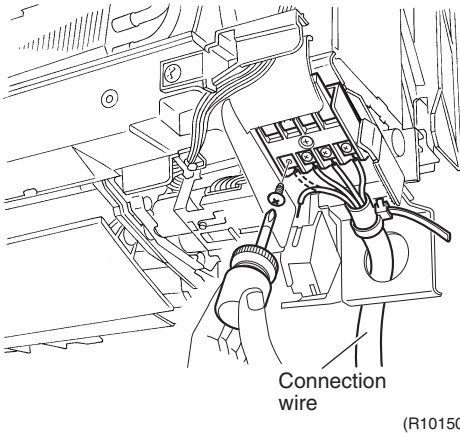
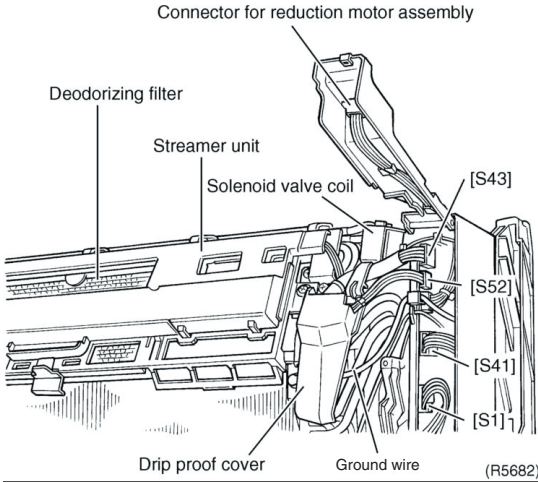

Warning Be sure to wait 10 minutes or more after turning off all power supplies before disassembling work.

Step	Procedure	Points
1. Disconnect the wire harnesses around the electrical box		
1 Open the cover of the electrical box.		
2 Remove the 4 screws of the terminal board to remove the connection wire.		
3 The figure shows the arrangement of wiring of wire harnesses (front) and names of parts.		

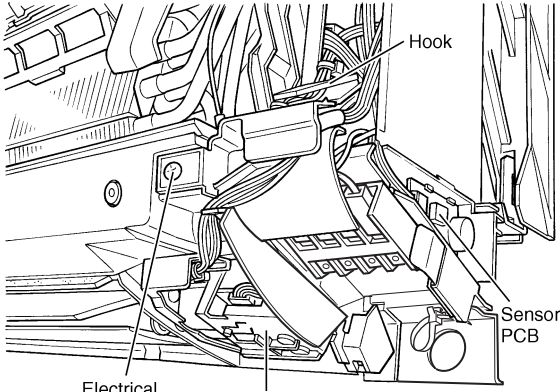
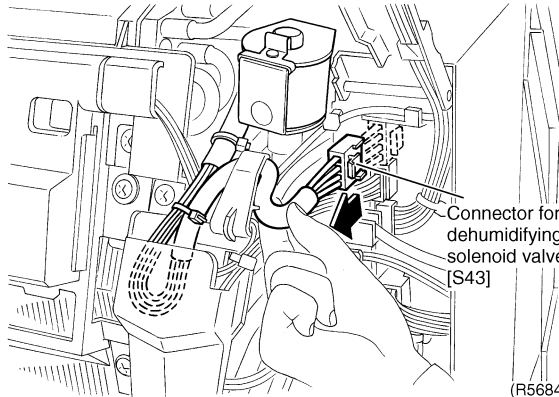
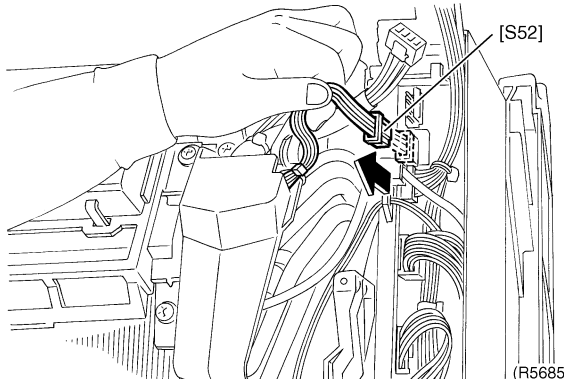
Step	Procedure	Procedure	Points
4	The figure shows the arrangement of wiring of wire harnesses (under) and names of parts.	 <p>Hook</p> <p>Sensor PCB</p> <p>Receiver PCB</p> <p>Electrical box screw</p> <p>(R10151)</p>	
5	Disconnect the connector for dehumidifying solenoid valve [S43].	 <p>Connector for dehumidifying solenoid valve [S43]</p> <p>(R5684)</p>	
6	Disconnect the connector for streamer unit [S52].	 <p>[S52]</p> <p>(R5685)</p>	

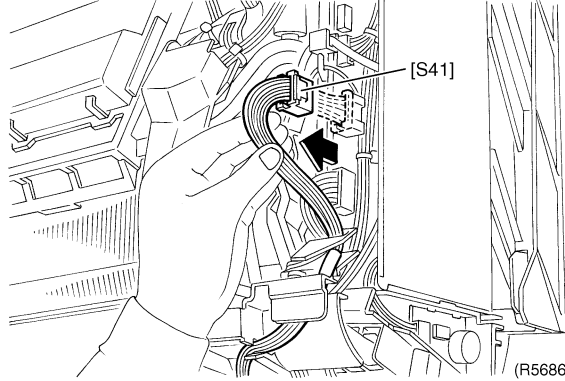
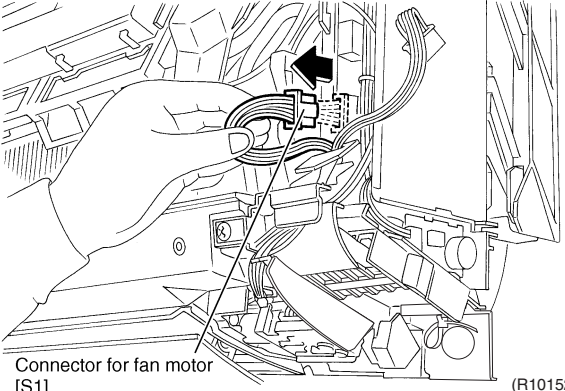
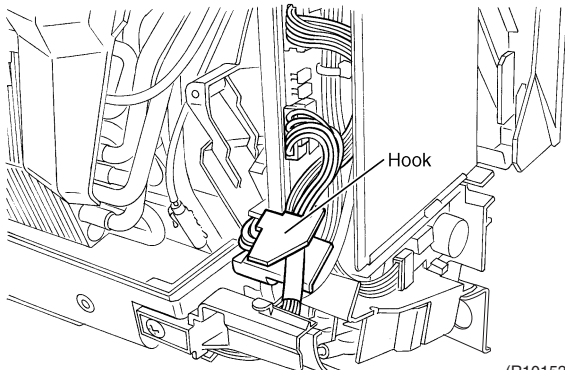
Step		Procedure	Points
7	Disconnect the connector for swing motor [S41].	 <p>(R5686)</p>	<ul style="list-style-type: none"> ■ The connector [S41] is for both horizontal blades and vertical blades.
8	Disconnect the connector for fan motor [S1], and release the 1 hook.	 <p>Connector for fan motor [S1]</p> <p>(R10152)</p>  <p>Hook</p> <p>(R10153)</p>	

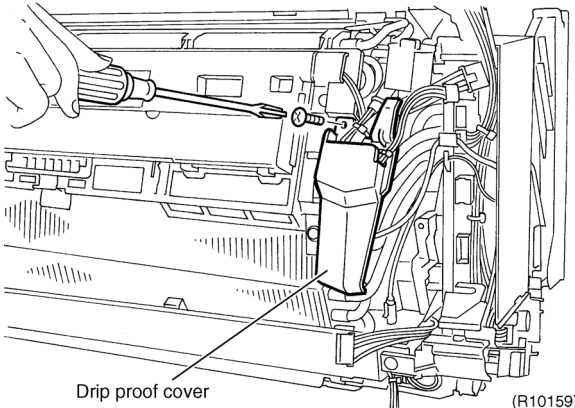
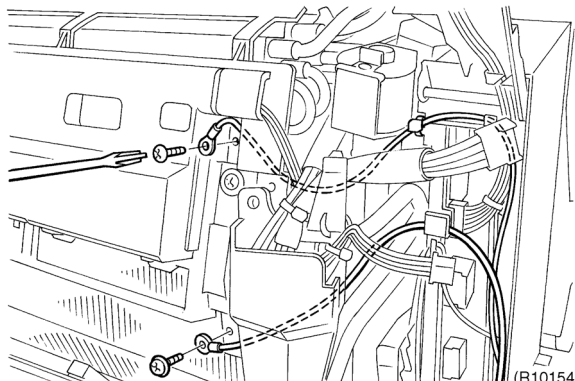
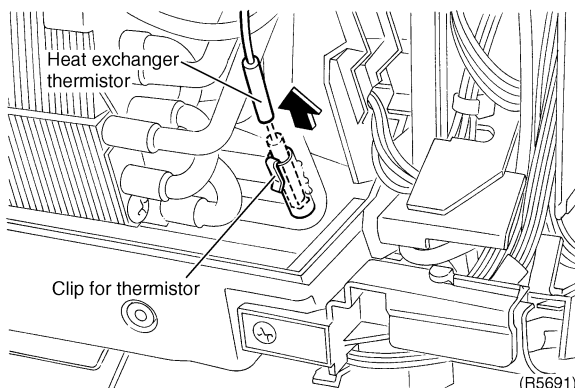
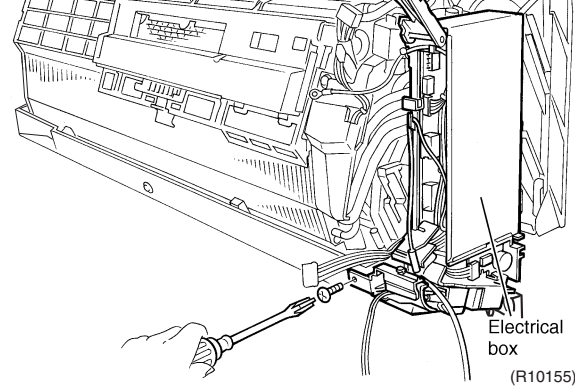
Step		Procedure	Points
9	Remove the screw of the drip proof cover.		
10	Remove the screw of the ground wire.		
11	Disconnect the heat exchanger thermistor.		<ul style="list-style-type: none"> ■ Be careful not to lose the clip for thermistor.
2. Removal of the electrical box			
1	Remove the screw of the electrical box.		

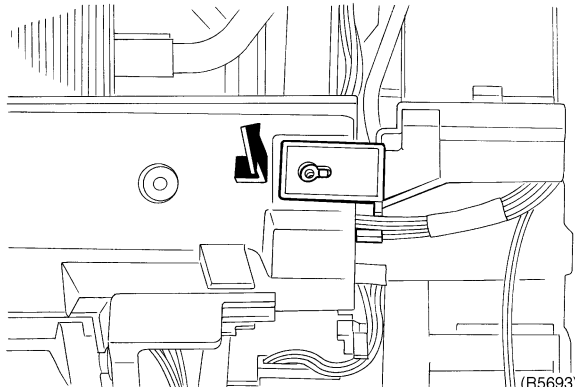
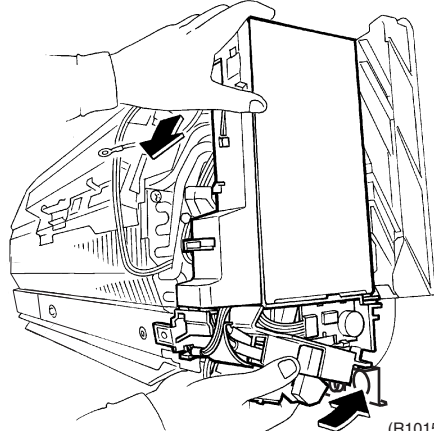
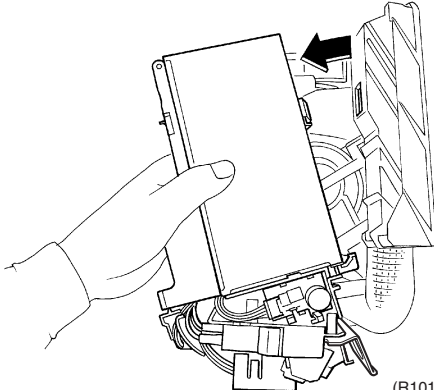
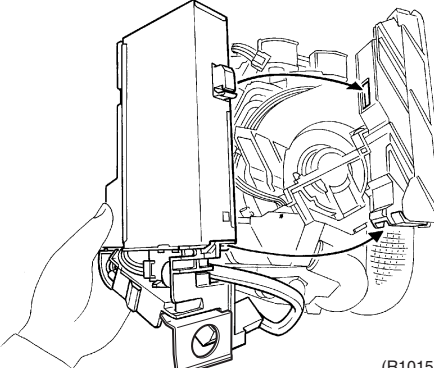
Step	Procedure	Procedure	Points
2	Close the cover and slide to undo the hook in the key hole.	 <p>(R5693)</p>	
3	Push up the bottom side of the electrical box, or push the bottom frame to the back.	 <p>(R10156)</p>	
4	Release the upper hook first.	 <p>(R10157)</p>	
5	The shapes of the hook on back side.	 <p>(R10158)</p>	<ul style="list-style-type: none"> ■ When assembling, insert the upper hook, push slightly, and make sure to catch the lower hook.

1.7 Removal of PCB

Procedure

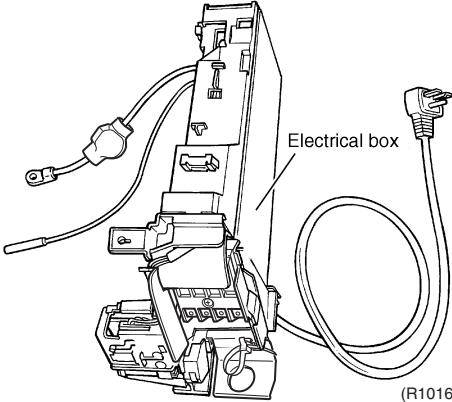
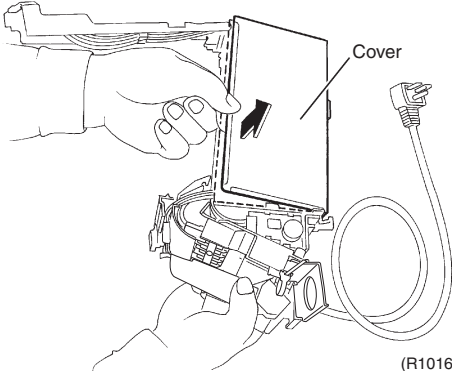
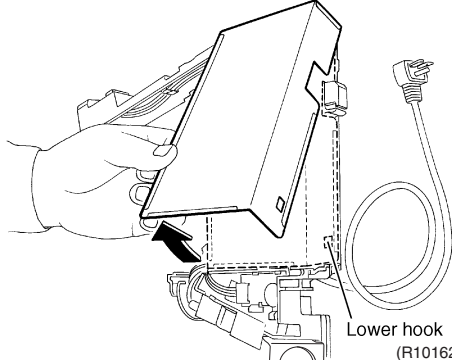

Warning Be sure to wait 10 minutes or more after turning off all power supplies before disassembling work.

Step	Procedure	Points
1. Removal of the shelter		Preparation ■ Remove the electrical box according to "Removal of the Electrical Box."
1	External appearance of the electrical box.	
		
2	Release the hook of the cover.	
		
3	While opening the shelter, undo the lower hook and lift the cover up to undo the upper hook on the back.	
		

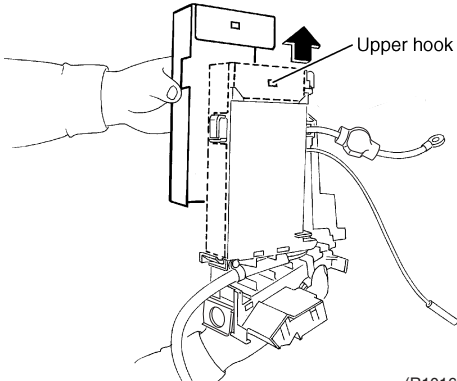
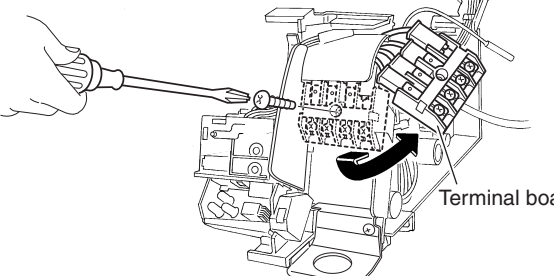
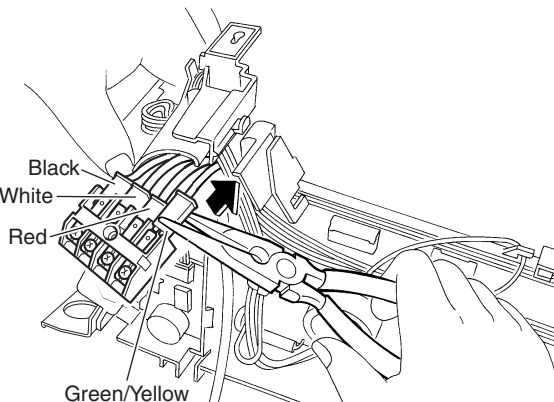
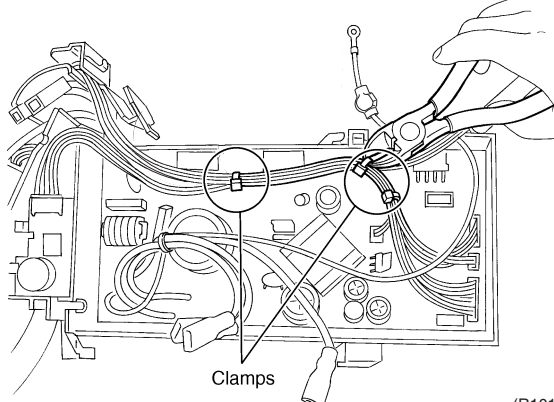
Step	Procedure	Procedure	Points
4	Slide the cover upward while lifting up (without being hooked) and undo the 2 sockets.	 <p>(R10163)</p>	
2. Removal of the power supply terminal board			
1	Remove the 1 screw and pull out the terminal board sideward.	 <p>(R10164)</p>	<p>Black (1) Power supply White (2) Power supply Red (3) Signal Green/Yellow ...earth</p>
2	On the terminal board, disconnect the red terminal with pliers and the black and white terminals with a flat screwdriver.	 <p>(R10165)</p>	
3. Removal of the control PCB			
1	Cut the 3 clamps.	 <p>(R10166)</p>	<p>■ Clamps should be used all the time. Fix it as it was before.</p>

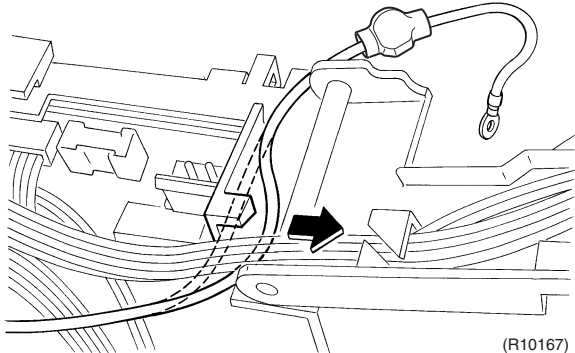
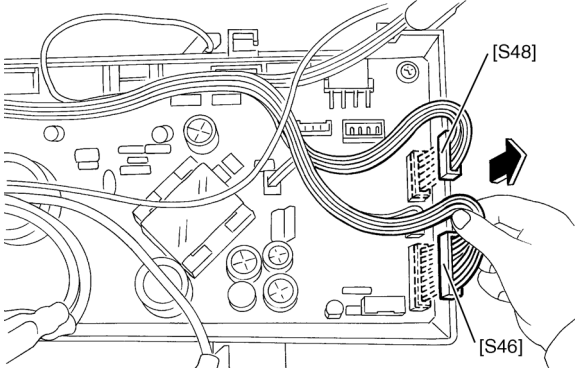
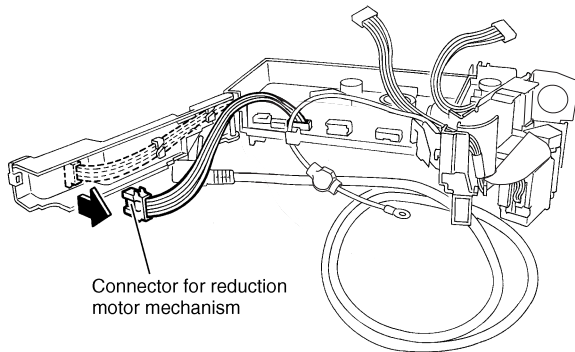
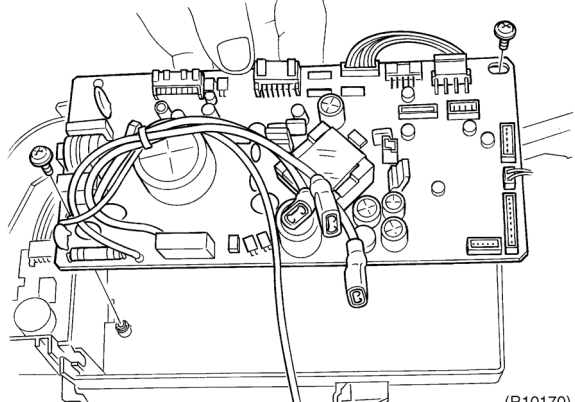
Step	Procedure	Procedure	Points
2	Release the ground wire from the hook.	 <p>(R10167)</p>	
3	Disconnect the connectors [S46] and [S48].	 <p>(R10168)</p>	<p>[S46]: to the display PCB [S56] [S48]: to the sensor PCB [CN1]</p>
4	Push out the connector for reduction motor mechanism while pinching the connector from the back side of the electrical box cover.	 <p>Connector for reduction motor mechanism</p> <p>(R10169)</p>	
5	Remove the 2 screws and remove the control PCB.	 <p>(R10170)</p>	

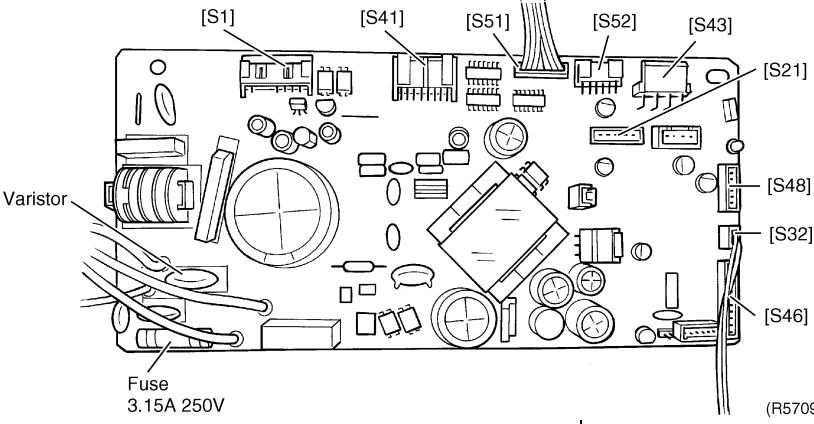
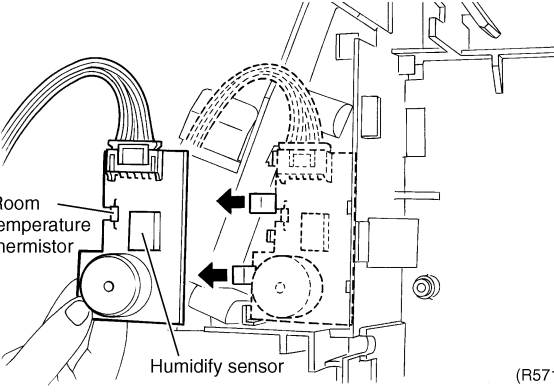
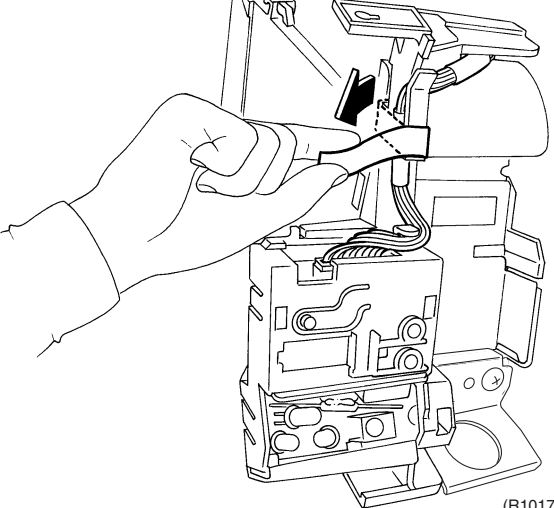
Step	Procedure	Procedure	Points
6	Names of parts of the control PCB.	 <p>[S1]: Fan motor [S21]: HA [S32]: Heat exchanger thermistor [S41]: Swing motor [S43]: Solenoid valve [S46]: to Display PCB [S48]: to Sensor PCB [S51]: Open/close mechanism [S52]: Streamer unit</p>	
4. Removal of the sensor PCB			
1	Release the 1 hook and pull out the sensor PCB.		
5. Removal of the receiver PCB and the display PCB			
1	The arrangement of the wire harnesses.		
2	Detach the fixing tape and disconnect the connector.		

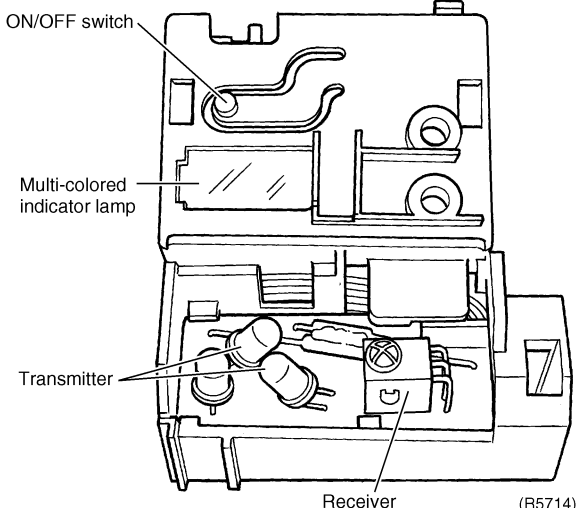
Step	Procedure	Points
3	Release the upper hook.	
4	Release the lower hook.	<ul style="list-style-type: none"> ■ Using a flat screwdriver makes it easy to undo the hook.
		 <p>(R5714)</p>

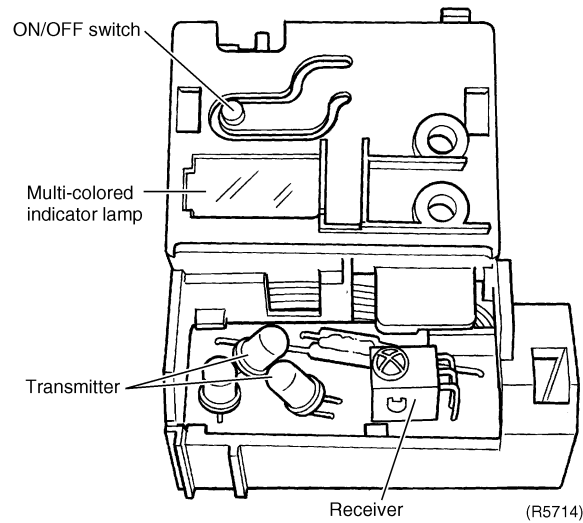
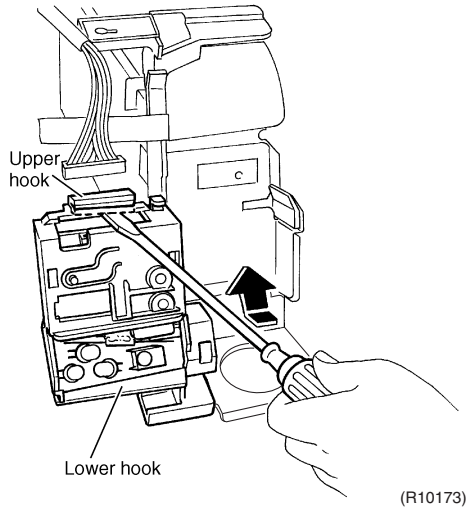
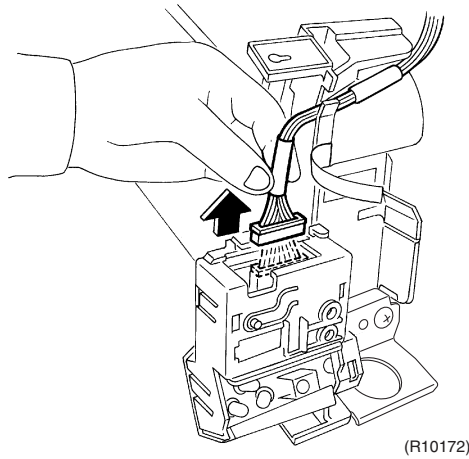

Step	Procedure	Points
5	<p>Release the 2 hooks of the receiver PCB and the 2 hooks of the display PCB.</p>	<p>■ The receiver PCB and the display PCB are united.</p>

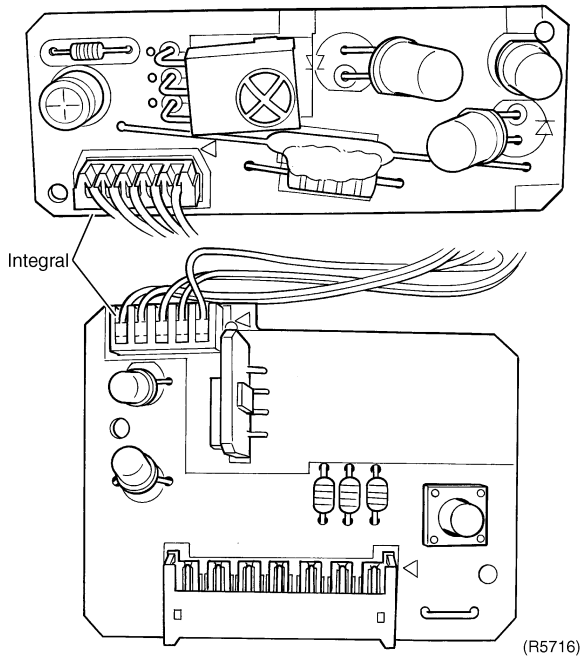
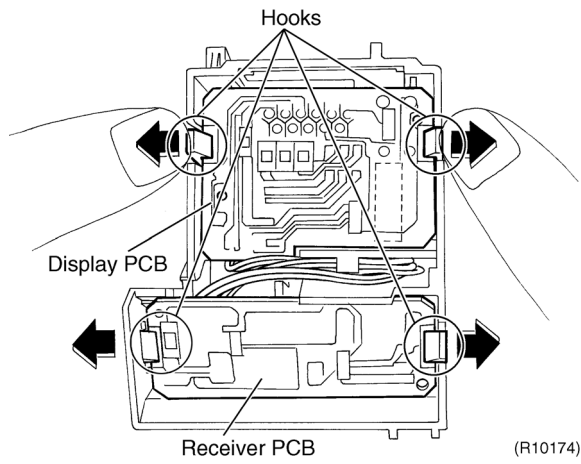

1.8 Removal of Dehumidifying Solenoid Valve Coil

Procedure

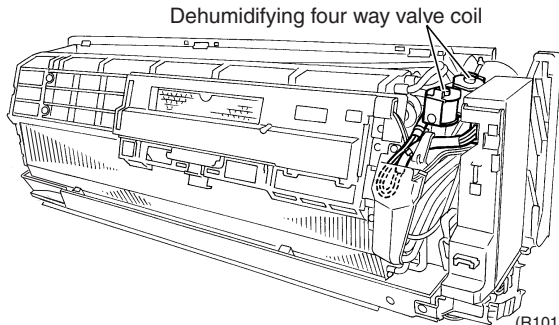
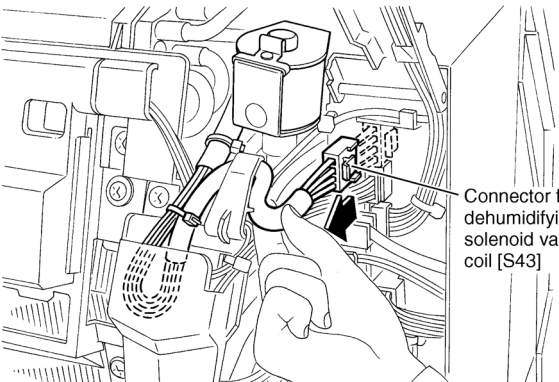
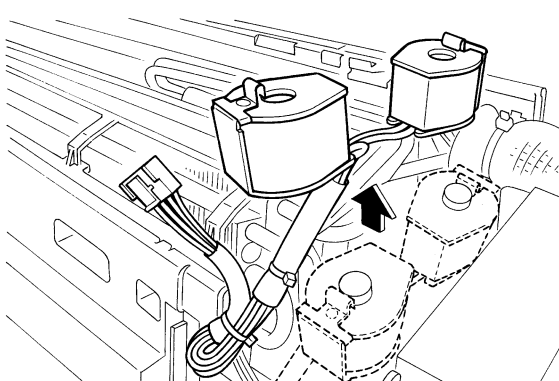

Warning Be sure to wait 10 minutes or more after turning off all power supplies before disassembling work.

Step	Procedure	Procedure	Points
1	Detach the lead wire from the drip proof cover.	 <p style="text-align: center;">Dehumidifying four way valve coil</p> <p style="text-align: right;">(R10175)</p>	<p>Preparation</p> <ul style="list-style-type: none"> ■ Remove the front grille according to "Removal of the Front Grille."
2	Disconnect the connector for dehumidifying solenoid valve [S43].	 <p style="text-align: right;">Connector for dehumidifying solenoid valve coil [S43]</p> <p style="text-align: right;">(R5718)</p>	
3	Pull the dehumidifying solenoid valve coil to remove.	 <p style="text-align: right;">(R5719)</p>	<ul style="list-style-type: none"> ■ Four-way valve does not need screws.

1.9 Removal of Drain Hose

Procedure



Warning Be sure to wait 10 minutes or more after turning off all power supplies before disassembling work.

Step	Procedure	Points
<p>1. Removal of the drain hose</p> <p>1 Remove the screws of the main unit and installation plate.</p> <p>2 Lift the main unit slightly and remove the drain hose, in case of piping as shown in figure on the right.</p>	<p>(R10176)</p> <p>Drain hose</p> <p>(R5727)</p>	<ul style="list-style-type: none"> ■ Cover the drain hose with plastic bags or the like so the remaining drainage will not wet the floor. ■ Part A is fixed by the screw from back side. When replacing the hose, make sure to tighten a screw as there is no gap between the heat insulator and the hose.
<p>2. How to change drain piping to the left</p> <p>1 Detach the drain plug on the left.</p>	<p>Drain plug</p> <p>(R5728)</p>	

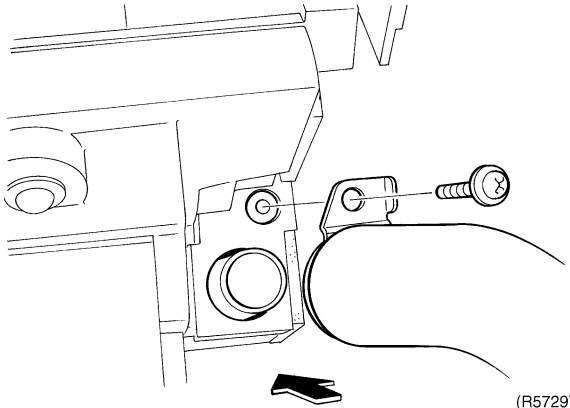
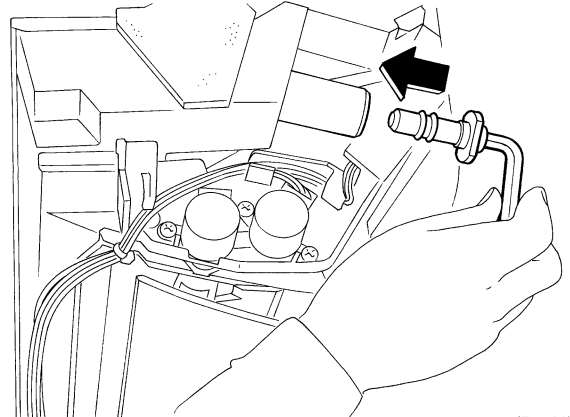
Step		Procedure	Points
2	Insert the drain hose removed in the previous step.	 <p>(R5729)</p>	<ul style="list-style-type: none">■ Make sure to check if the drain hose is inserted firmly.
3	Insert the detached drain plug with an Allen wrench (4mm).	 <p>(R5730)</p>	<p>⚠ Caution Do not push the drain plug with a sharp device like a screwdriver as it can damage the drain plug, resulting in water leakage.</p>

1.10 Removal of Swing Motor

Procedure

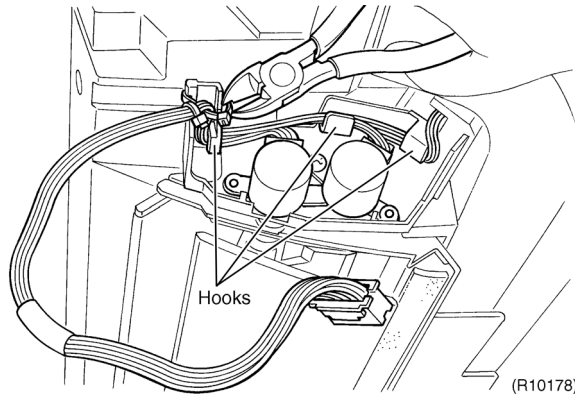
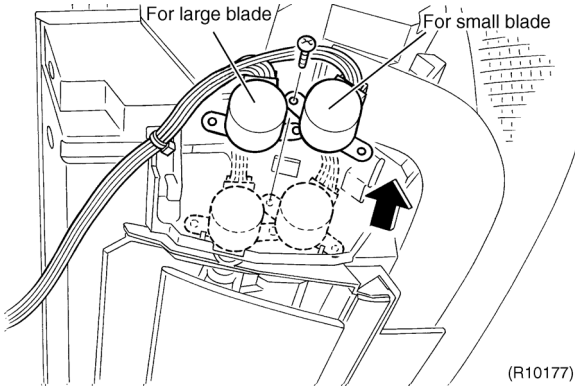
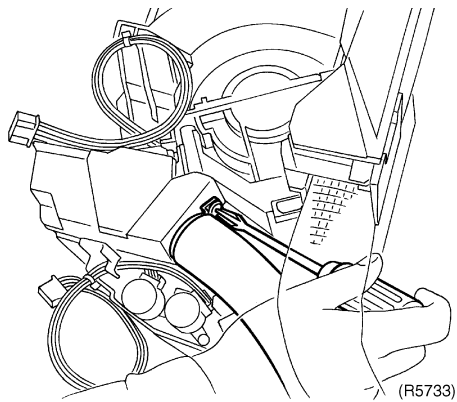

Warning Be sure to wait 10 minutes or more after turning off all power supplies before disassembling work.

Step	Procedure	Points
<p>1. Removal of the swing motor for horizontal blade</p> <p>1 There are 3 hooks for the lead wire for swing motor.</p> <p>2 Cut the clamp with nippers.</p> <p>3 Undo the lead wire for swing motor from the hooks.</p> <p>4 Remove the 1 screw and remove the swing motor for the horizontal blades (large) and for the horizontal blades (small).</p>	 <p>(R10178)</p>  <p>(R10177)</p>	<p>Preparation</p> <ul style="list-style-type: none"> ■ Remove the electrical box according to "Removal of the Electrical Box." ■ The connector for swing motor is disconnectable. ■ The same swing motors are used for both large and small horizontal blades.
<p>2. Removal of the swing motor for vertical blades</p> <p>1 Remove the 1 screw of the drain hose.</p>	 <p>(R5733)</p>	<ul style="list-style-type: none"> ■ Working without removing the drain hose is possible.

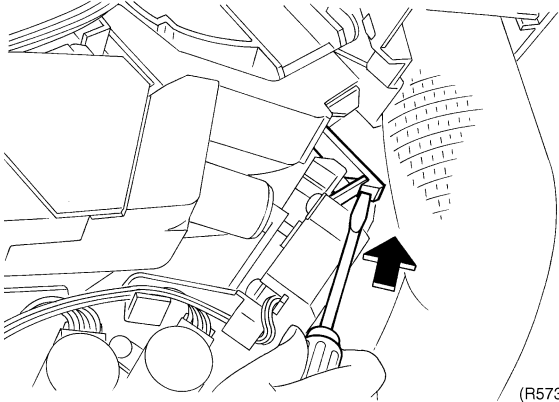
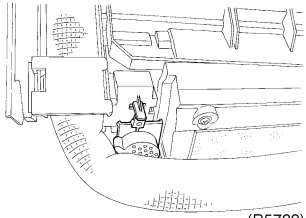
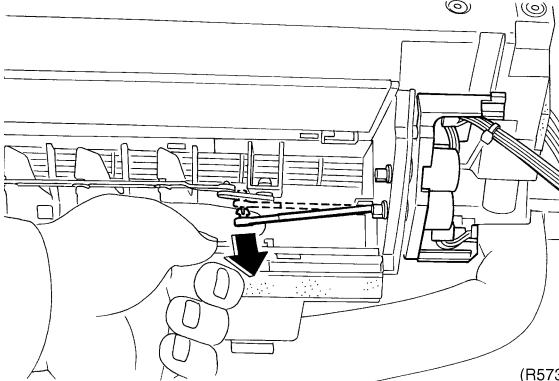
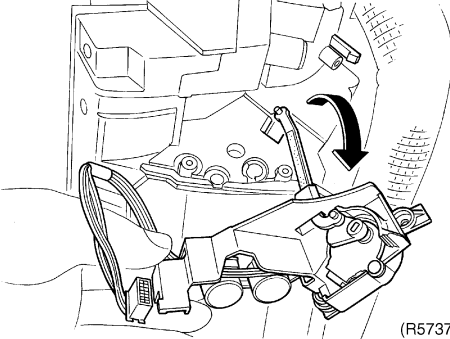
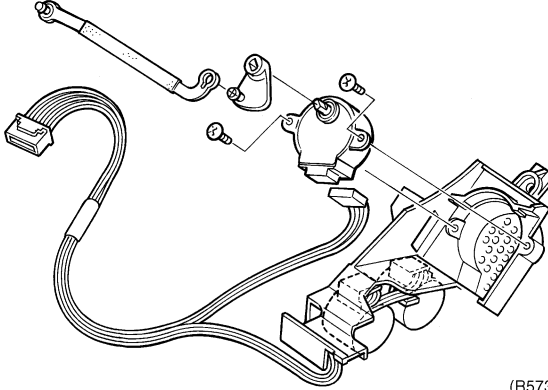
Step		Procedure	Points
3	Release the upper hook of the cover with a flat screwdriver.	 <p>(R5735)</p>	 <p>(R5739)</p> <ul style="list-style-type: none"> ■ The hook on the back of the assembly of swing motor.
4	Release the hook of connecting shaft for vertical blades.	 <p>(R5736)</p>	
5	Remove the assembly of swing motor.	 <p>(R5737)</p>	
6	Remove the 2 screws of the swing motor for vertical blades.	 <p>(R5738)</p>	<ul style="list-style-type: none"> ■ When assembling the swing motor for vertical blades, remove the drain hose.

1.11 Removal of Heat Exchanger

Procedure

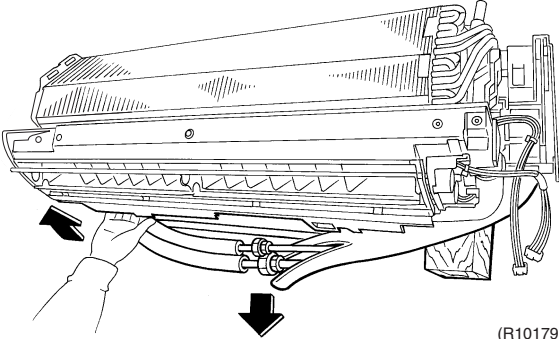
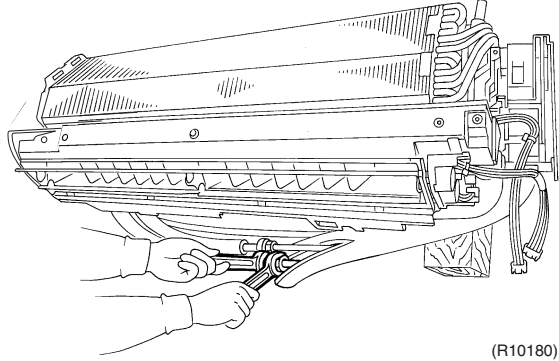
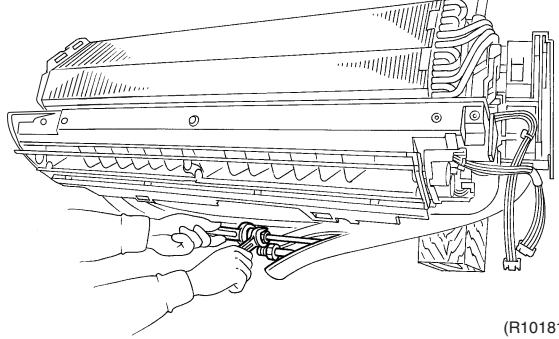

Warning Be sure to wait 10 minutes or more after turning off all power supplies before disassembling work.

Step	Procedure	Points
1. Removal of the refrigerant piping		<p>Preparation</p> <ul style="list-style-type: none"> Remove the drain hose according to "Removal of Drain Hose."
1	<p>Put a wooden block under the indoor unit and pull out the refrigerant piping, drain hose, connection wirings, and so on.</p>  <p style="text-align: right;">(R10179)</p>	
2	<p>Disconnect the flare nut of the connection of gas pipe with 2 spanners.</p>  <p style="text-align: right;">(R10180)</p>	<p>Caution</p> <p>In pump-down work, be sure to stop the compressor before disconnecting the refrigerant pipe. If the refrigerant pipe is disconnected with the compressor running and the stop valve being open, air may be sucked in and cause an over-pressure in refrigeration cycle, thus resulting in pipe rupture or accidental injury.</p>
3	<p>Disconnect the flare nut of the connection of liquid pipe with 2 spanners.</p> <p>Caution From the point of view of environmental protection, be sure to use a vacuum pump for air purging.</p>  <p style="text-align: right;">(R10181)</p>	<ul style="list-style-type: none"> Be careful that remaining drain water will not wet the floor. If the drain hose is embedded in the wall, disconnect the drain hose beforehand. Carry out the removal works with 2 pair of spanners.

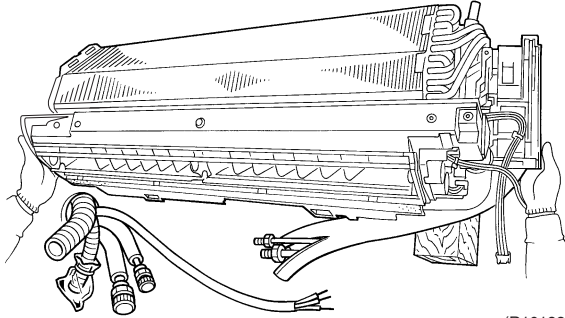
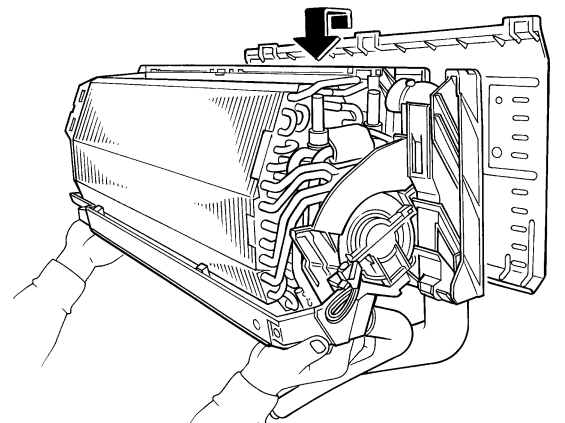
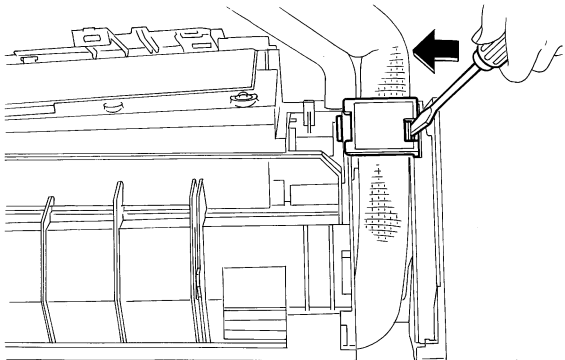
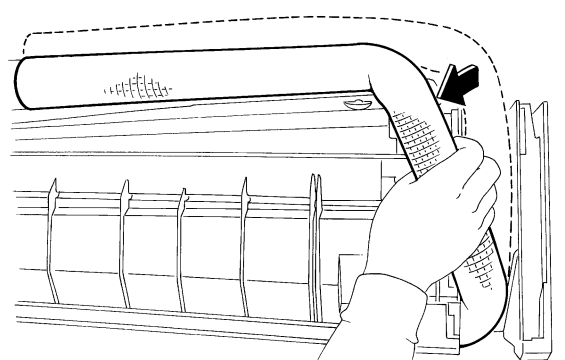
Step	Procedure	Points
<p>2. Removal of the indoor unit</p> <p>1 Remove the indoor unit from the installation plate.</p>	 <p>(R10182)</p>  <p>(R5744)</p>	<ul style="list-style-type: none"> When the pipes are disconnected, protect both the pipe side and unit side openings from any moisture entering.
<p>3. Removal of the heat exchanger</p> <p>1 Unfasten the hook of the pipe fixing plate at the back of the unit and pull out the pipe.</p> <p>2 Widen the auxiliary pipe by about 10-20 degrees.</p>	 <p>(R5745)</p>  <p>(R5746)</p>	<ul style="list-style-type: none"> Release the 2 hooks on the side with a flat screwdriver.

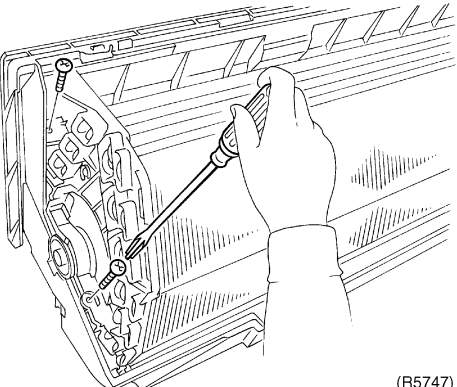
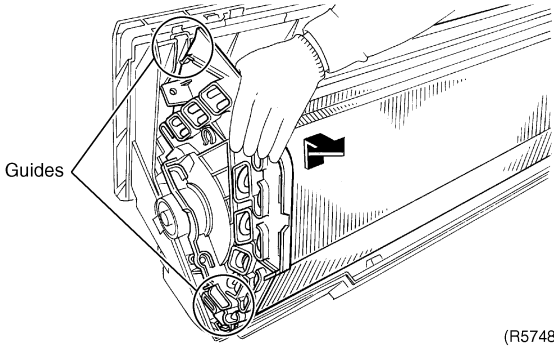
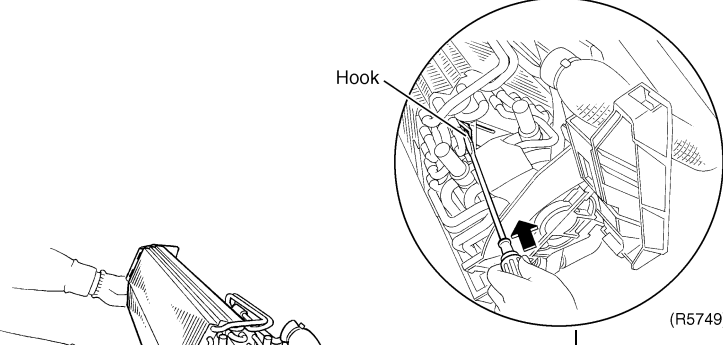
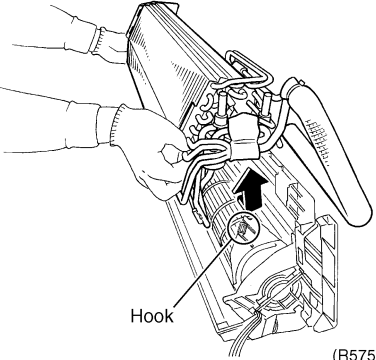
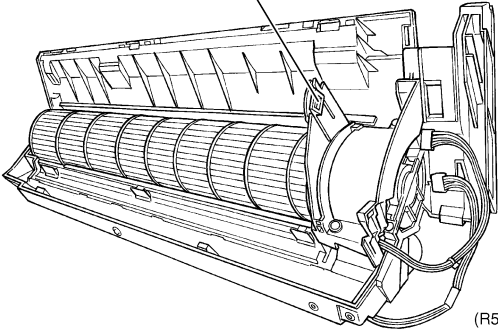
Step	Procedure	Procedure	Points
3	Remove the 2 fixing screws for heat exchanger on the left.	 <p>(R5747)</p>	
4	Lift the left side of the heat exchanger, and pull toward yourself.	 <p>(R5748)</p>	<p>! Caution When dismantling or mounting the heat exchanger, be sure to wear gloves or wrap it with cloth before proceeding with the work as fins can injure your hands.</p>
5	Release the hook through the gap in the pipes.	 <p>(R5749)</p>	
6	Slide to right to undo the hook and lift the heat exchanger up.	 <p>(R5750)</p>  <p>(R5751)</p>	<p>■ Be careful so the solenoid valve will not be caught in the hook.</p>

1.12 Removal of Propeller Fan / Fan Motor

Procedure

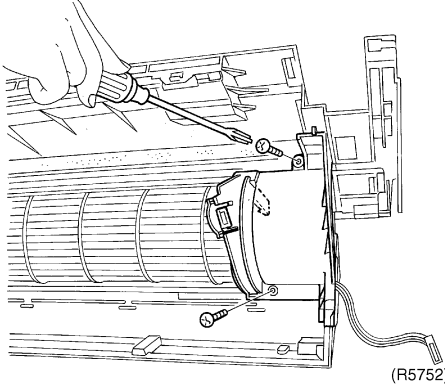
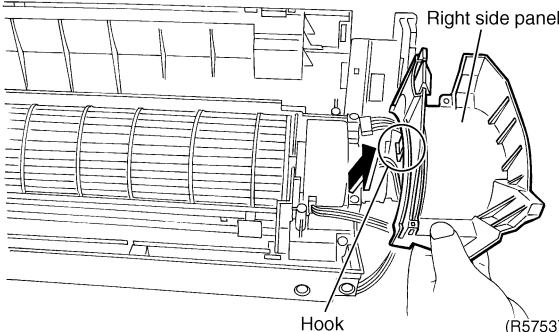
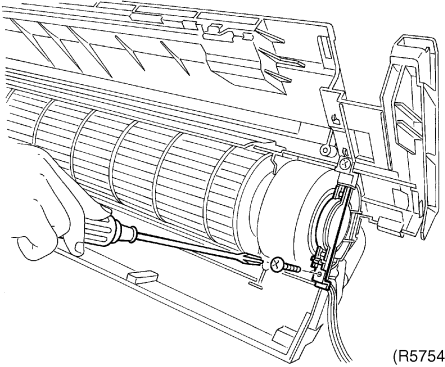
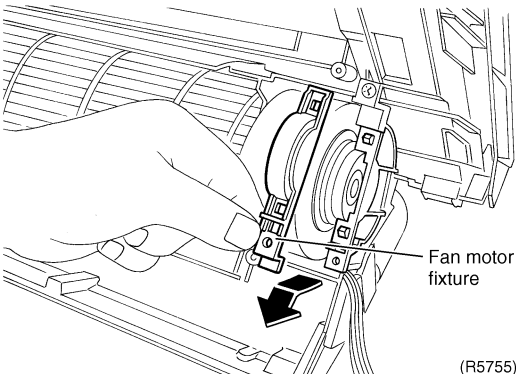

Warning Be sure to wait 10 minutes or more after turning off all power supplies before disassembling work.

Step	Procedure	Points
<p>1. Removal of the right side panel</p> <p>1 Remove the 2 screws of the right side panel.</p> <p>2 Release the far side hook of the right side panel while inclining toward yourself and then remove it.</p>	 <p>(R5752)</p>  <p>Right side panel</p> <p>Hook</p> <p>(R5753)</p>	<p>Preparation</p> <ul style="list-style-type: none"> Remove the heat exchanger according to "Removal of the Heat Exchanger."
<p>2. Removal of the fan rotor</p> <p>1 Remove the 1 screw of the fan motor fixture.</p> <p>2 Release the 2 hooks and remove the fan motor fixture.</p>	 <p>(R5754)</p>  <p>Fan motor fixture</p> <p>(R5755)</p>	

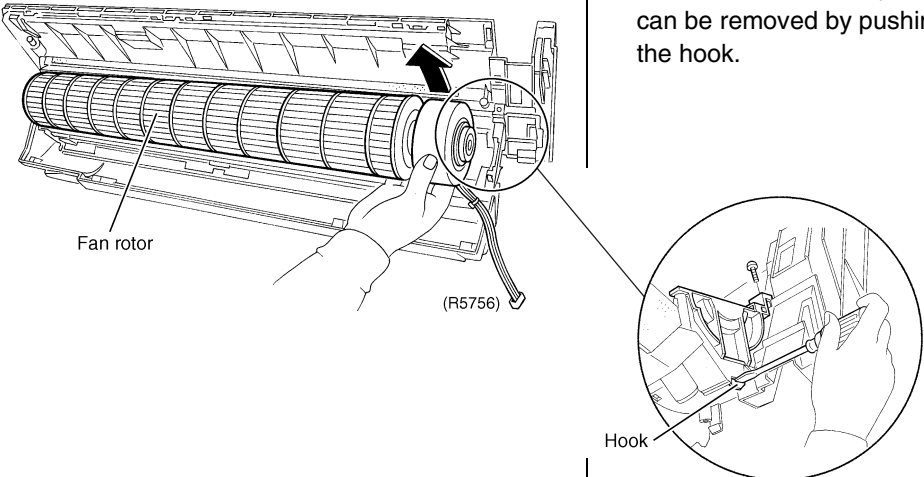
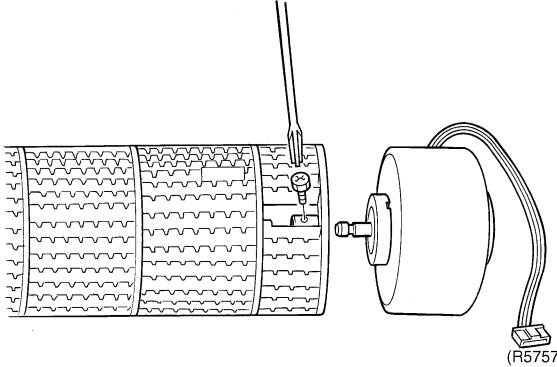
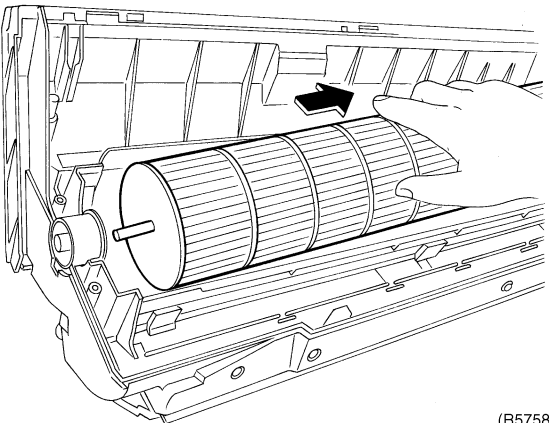
Step	Procedure	Points
3	Remove the fan motor and fan rotor.	 <p>Fan rotor</p> <p>(R5756)</p> <p>Hook</p> <ul style="list-style-type: none"> ■ The fan motor fixture (lower) can be removed by pushing the hook.
3. Removal of the fan motor	<ol style="list-style-type: none"> 1 Remove the fixing screw for fan rotor and fan motor. 2 Remove the fan motor and fan rotor. 	 <p>(R5757)</p>
4. Removal of the bearing	<ol style="list-style-type: none"> 1 Remove the fan rotor. 	 <p>(R5758)</p>

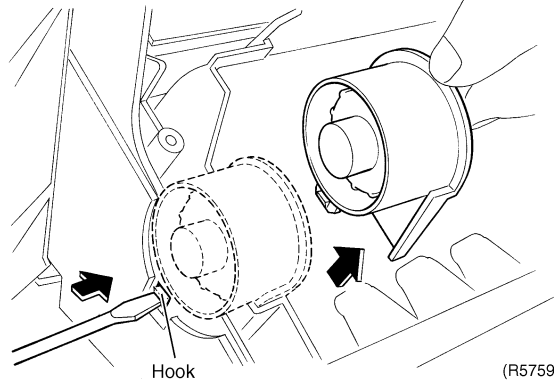
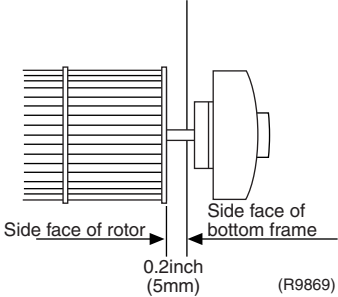
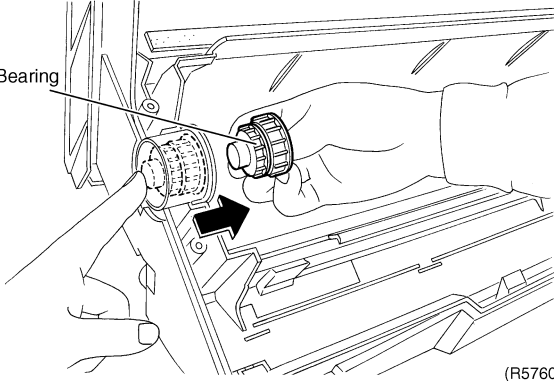
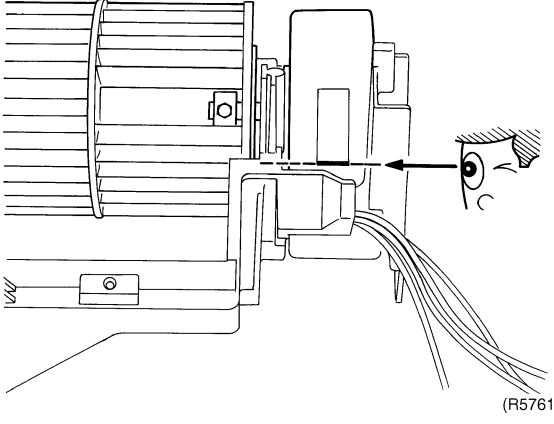
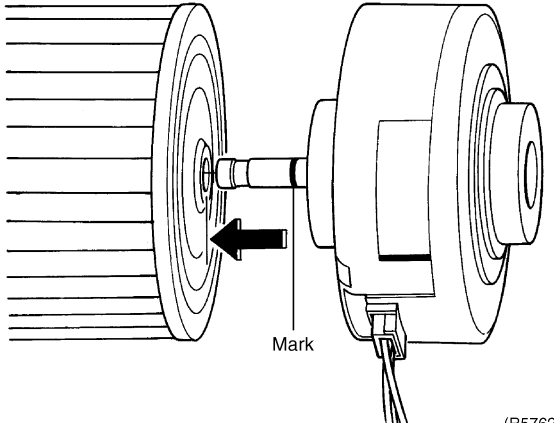
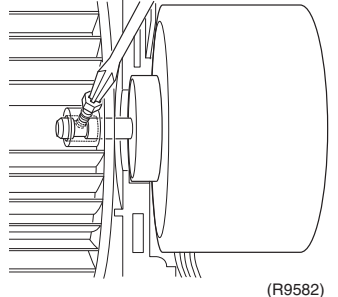
Step	Procedure	Procedure	Points
2	Undo the 1 hook of the bearing.	 <p>Hook (R5759)</p>	<p>■ Reassembling the fan motor: When reassembling the fan rotor, provide as much as 0.2inch (5mm) of play between the side face of the rotor and the bottom frame.</p>  <p>Side face of rotor Side face of bottom frame 0.2inch (5mm) (R9869)</p>
3	The bearing is made of rubber. Push it inward firmly and remove it.	 <p>Bearing (R5760)</p>	
5. How to install the fan motor		 <p>(R5761)</p>  <p>Mark (R5762)</p>	
1	When assembling, align the mark on the shaft.	 <p>(R9582)</p>	<ol style="list-style-type: none"> ① Insert the fan motor approx. 0.2inch (5mm) ② Tighten the screw until it stops. Then turn the screw in one scroll. ③ Move the fan rotor and confirm the fan motor and the fan rotor are installed appropriately. ④ Tighten the screw completely if appropriate. ⑤ If not appropriate, go back to ①.

1.13 Removal of Horizontal Blades / Vertical Blades

Procedure

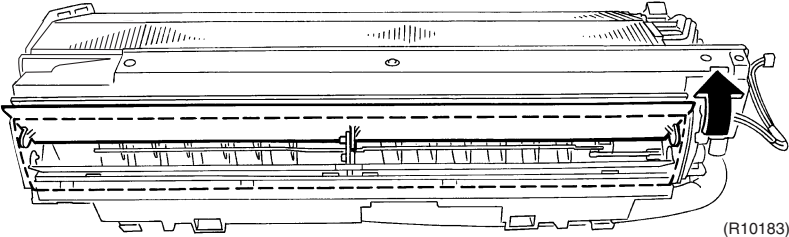
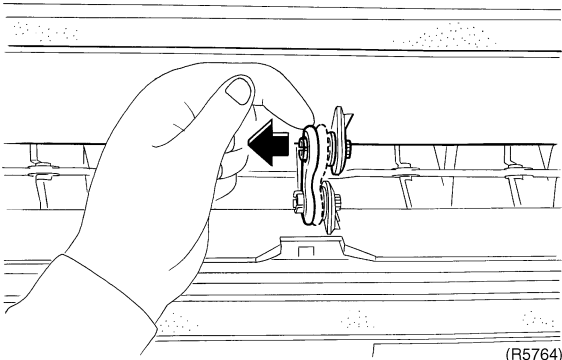
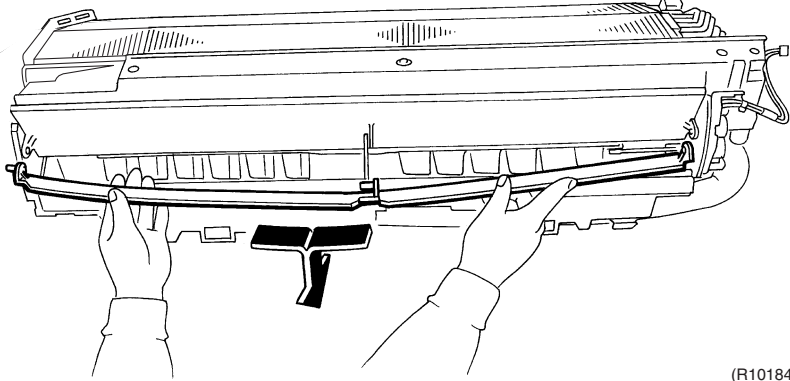
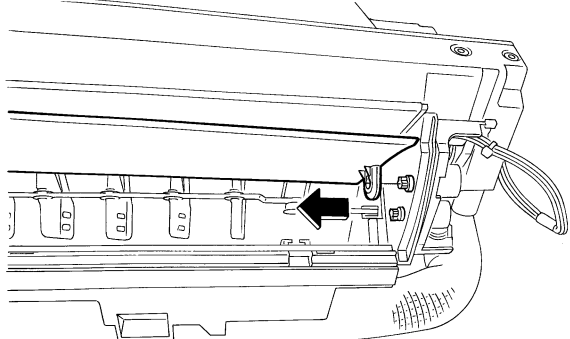

Warning Be sure to wait 10 minutes or more after turning off all power supplies before disassembling work.

Step	Procedure	Points
<p>1. Removal of the horizontal blade</p>		
1	<p>Open the horizontal blade (large).</p>  <p style="text-align: right;">(R10183)</p>	
2	<p>Release the center fixture for the horizontal blade (large).</p>  <p style="text-align: right;">(R5764)</p>	<p>■ When installing the horizontal blades, be careful not to put the large and small blades in the wrong position.</p>
3	<p>Release the left shaft while bending the horizontal blade (small) slightly. Remove the horizontal blade (small).</p>  <p style="text-align: right;">(R10184)</p>	
4	<p>Release the right shaft of the horizontal blade (large), and then remove the blade.</p>  <p style="text-align: right;">(R5766)</p>	<p>■ There is a key alignment mark at the right side.</p>

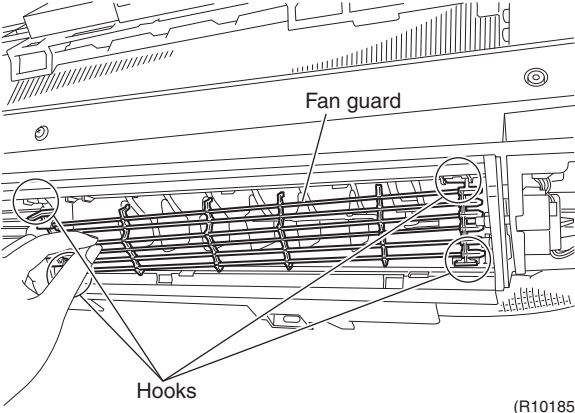
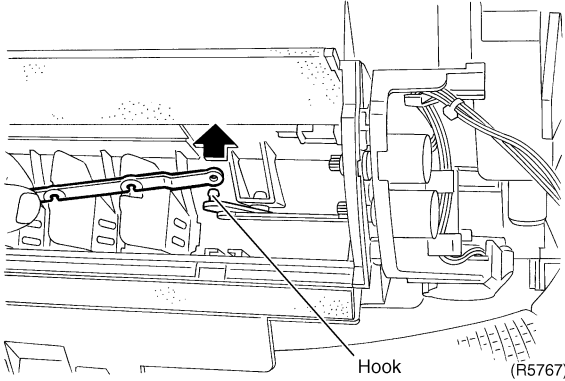
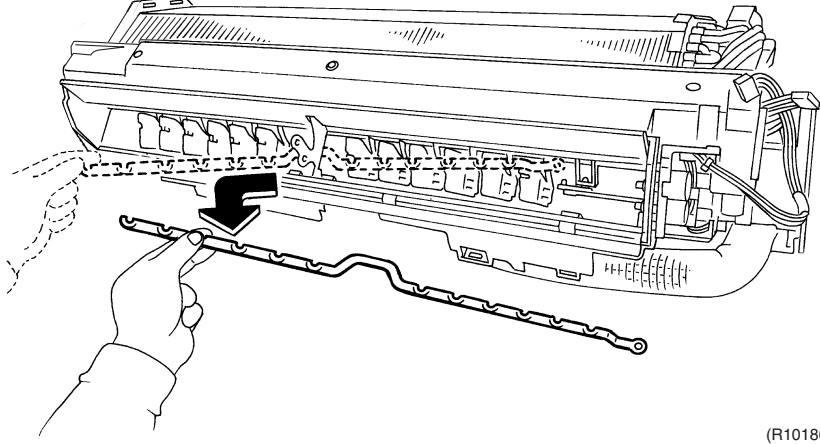
Step	Procedure	Points
2. Removal of the fan guard	<p data-bbox="201 247 472 373">1 Release the 4 hooks of the fan guard and pull it out toward yourself to remove.</p> 	
3. Removal of the interlocking shaft	<p data-bbox="201 783 472 846">1 Release the hook of the interlocking shaft.</p>  <p data-bbox="201 1171 472 1234">2 Remove the interlocking shaft.</p> 	

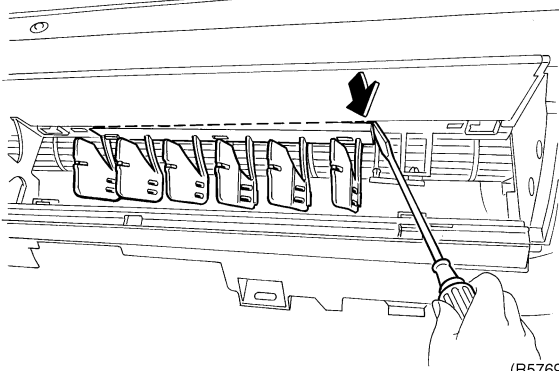
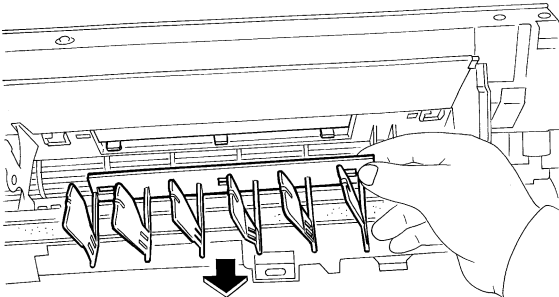
Step	Procedure	Points
4. Removal of the vertical blades	<p data-bbox="201 279 488 373">1 Release the 3 hooks of the vertical blades with a flat screwdriver.</p>  <p data-bbox="1031 636 1091 653">(R5769)</p> <p data-bbox="201 678 428 737">2 Remove the vertical blades.</p>  <p data-bbox="1031 1031 1091 1047">(R5770)</p>	

1.14 Removal of Streamer Unit

Procedure

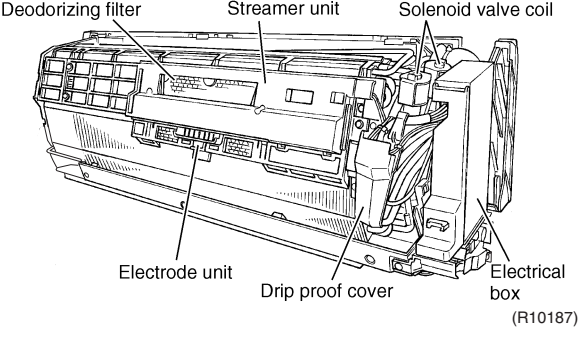
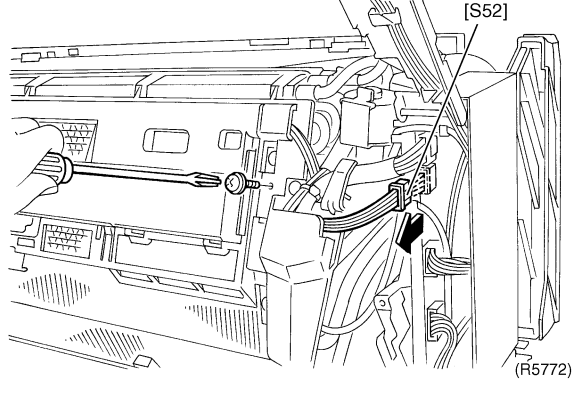
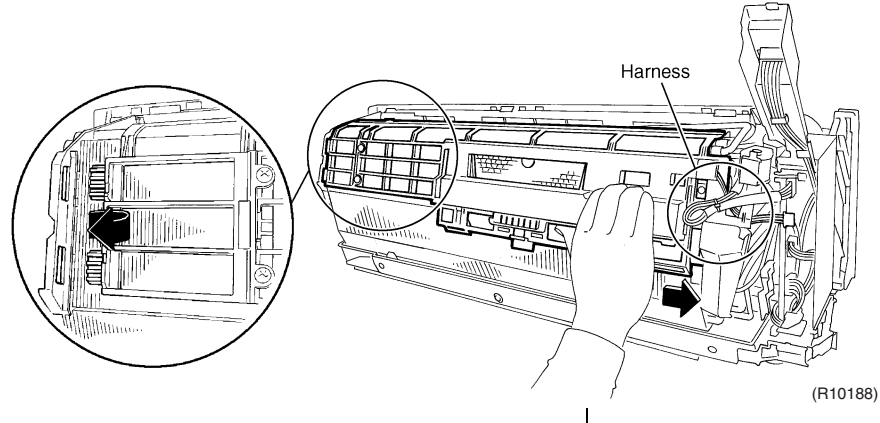

Warning Be sure to wait 10 minutes or more after turning off all power supplies before disassembling work.

Step	Procedure	Points
1.	Removal of the streamer unit	
1	Names of parts of the streamer unit. 	
2	Open the cover of the electrical box, disconnect the connector for streamer unit [S52], and remove the 1 screw. 	
3	Release the wire harness for solenoid valve coil from drip proof cover. 	

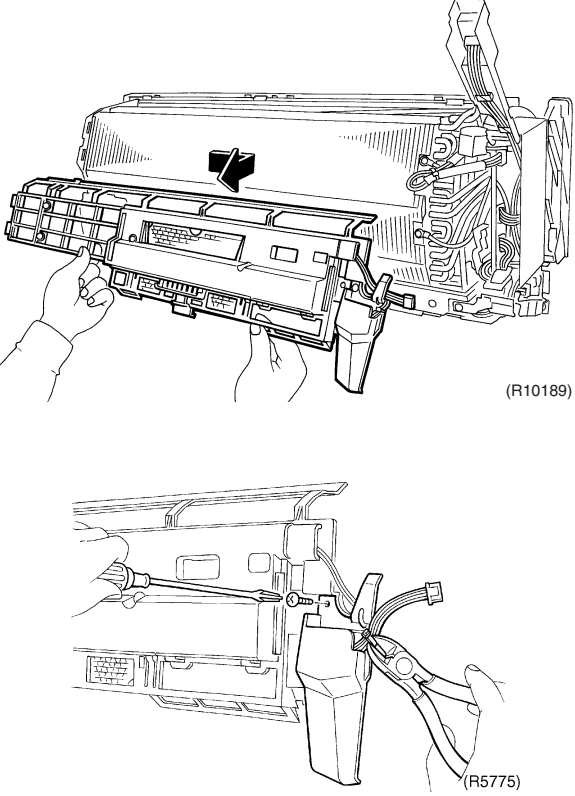
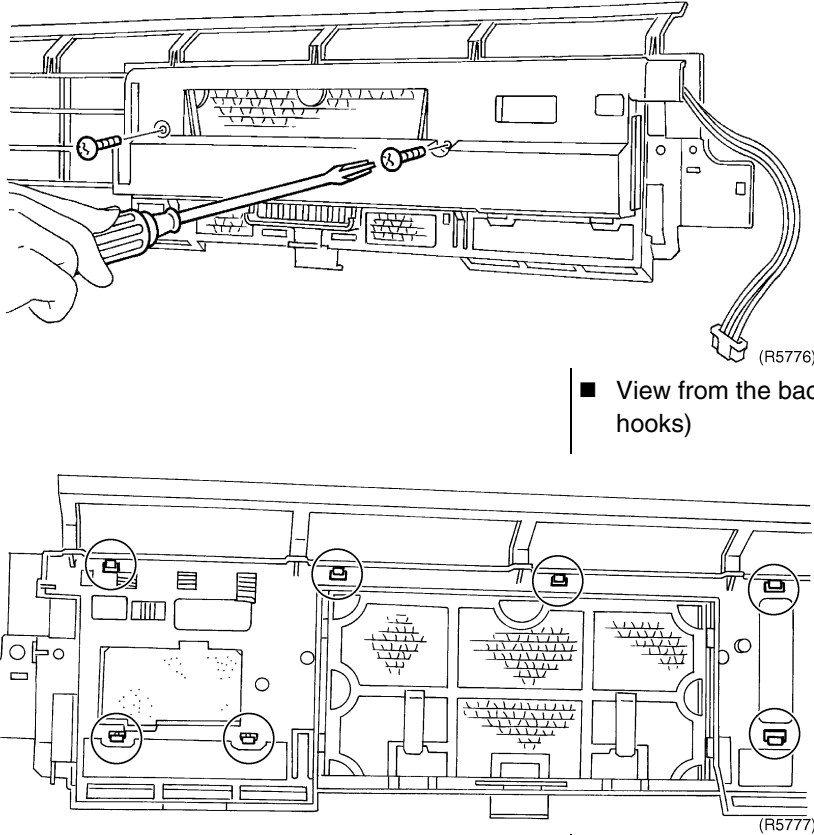
Step	Procedure	Points
<p>4 Slide the streamer unit to the right side.</p> <p>5 Remove it toward yourself.</p> <p>6 Cut the clamp and remove the 1 screw of the drip proof cover.</p>	 <p>(R10189)</p> <p>(R5775)</p>	
<p>2. Removal of the cover of streamer unit</p>	 <p>(R5776)</p> <p>■ View from the back side (7 hooks)</p> <p>(R5777)</p>	

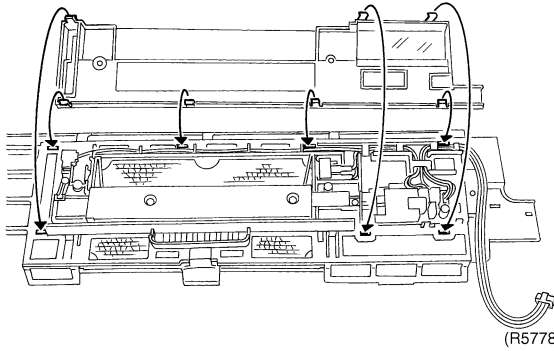
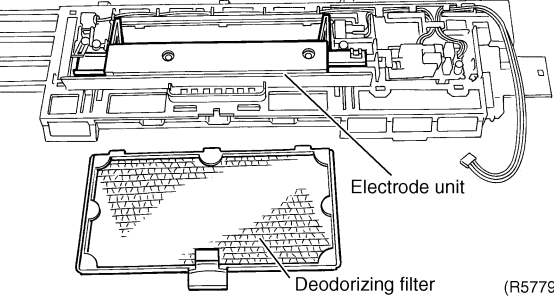
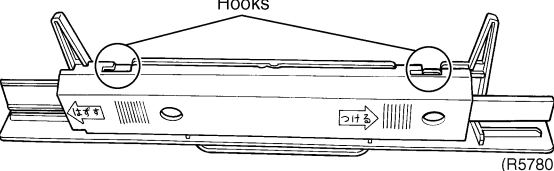
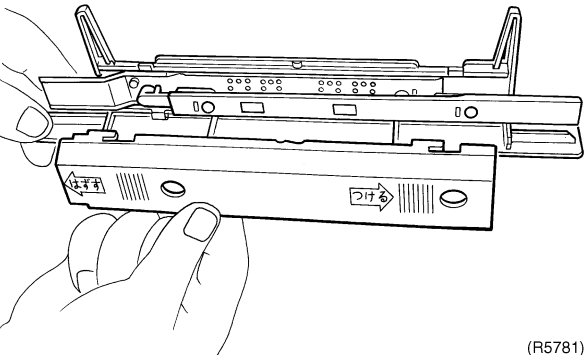
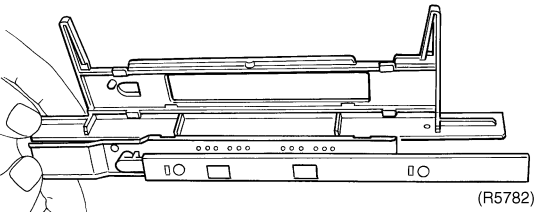
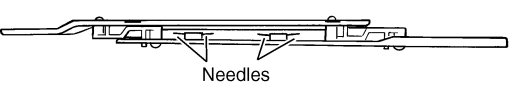
Step	Procedure	Procedure	Points
2	Turn it back and undo the 7 hooks.	 <p>(R5778)</p>	
3. Removal of the deodorizing filter and electrode unit			<ul style="list-style-type: none"> ■ See page 158 for removal of the deodorizing filter.
1	Remove the deodorizing filter and electrode unit.	 <p>Electrode unit Deodorizing filter</p> <p>(R5779)</p>	
2	Slide the cover of the electrode unit to the left to remove.	 <p>Hooks</p> <p>(R5780)</p>  <p>(R5781)</p>	<ul style="list-style-type: none"> ■ When assembling, slide to the right.
3	Electrode for discharging.	 <p>(R5782)</p> <p><Side view></p>  <p>Needles</p> <p>(R5783)</p>	

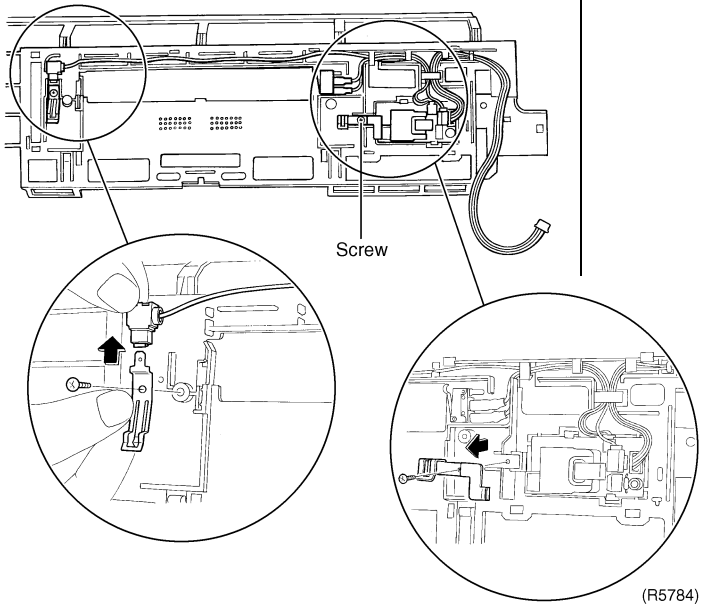
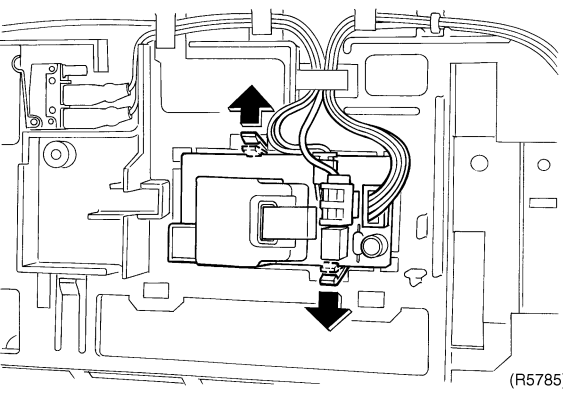
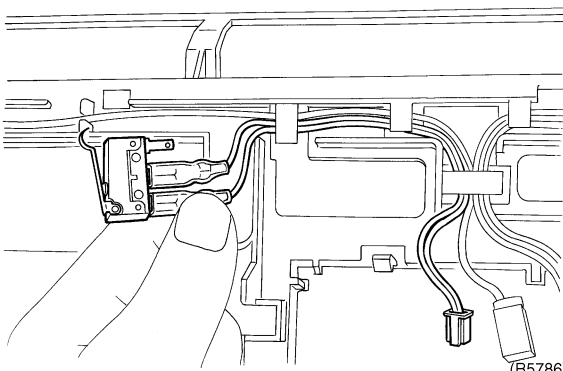
Step	Procedure	Points
<p>4. Removal of the streamer unit PCB</p>	<p>1 Remove the 1 screw of the electrode plate with a precise screwdriver.</p>  <p>(R5784)</p> <p>2 Release the 2 hooks of the streamer unit PCB.</p>  <p>(R5785)</p>	
<p>5. Disconnect the limit switch</p>	<p>1 Disconnect the limit switch.</p>  <p>(R5786)</p>	

2. Outdoor Unit

2.1 How to Check the Service Monitor (LED A)

Procedure

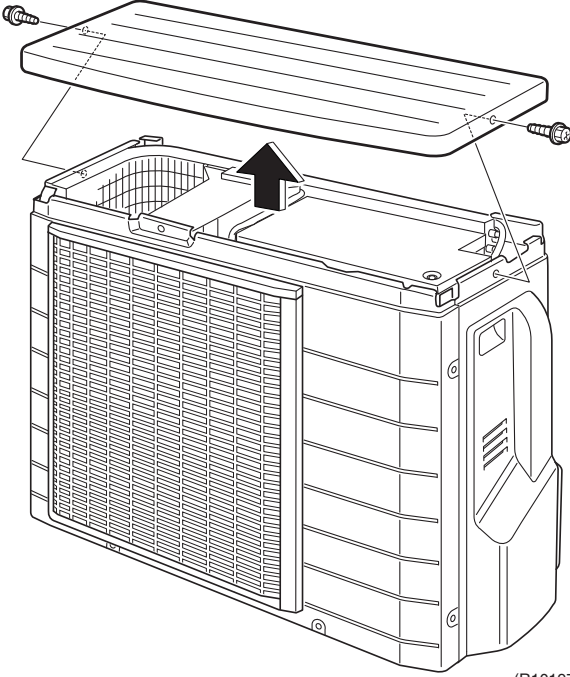
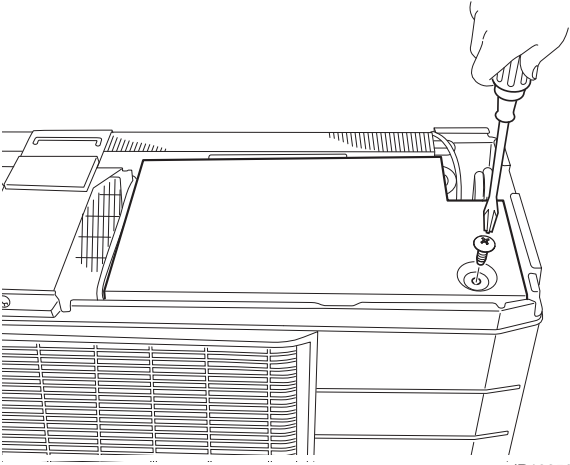

Warning Be sure to wait 10 minutes or more after turning off all power supplies before disassembling work.

Step	Procedure	Points
<p>1. Remove the top panel</p> <p>1 Remove the 2 screws of the top panel.</p>	 <p>(R10197)</p>	
<p>2. Remove the electrical box (cover).</p> <p>1 Remove the 1 screw of the electrical box (cover).</p>	 <p>(R10252)</p>	

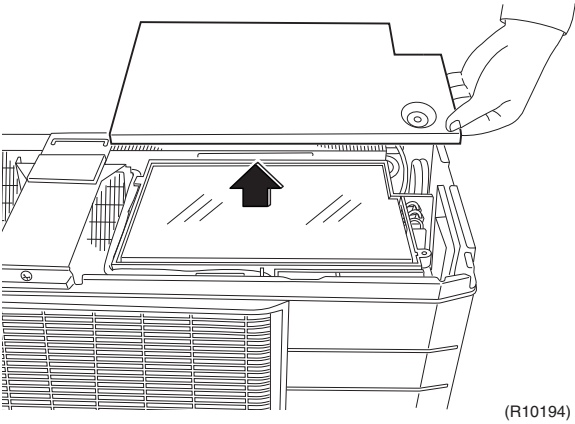
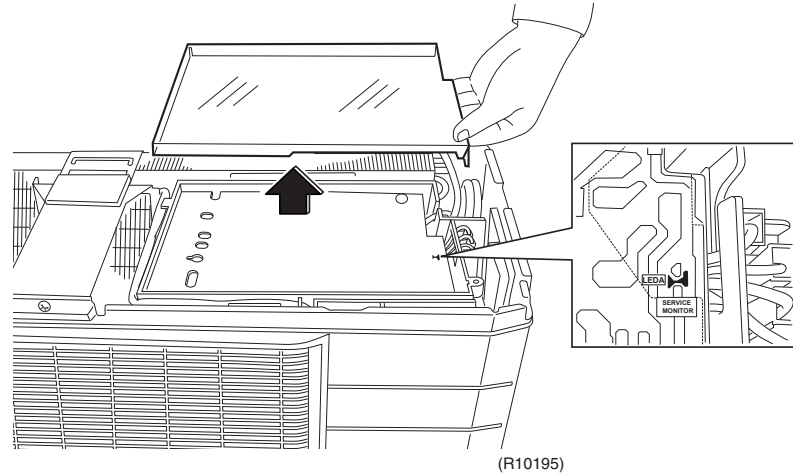
Step		Procedure	Points
2	Lift the electrical box (cover) and remove it.	 <p>(R10194)</p>	
3.	Remove the drip proof cover	<p>1 Lift the insulation sheet and remove it.</p>  <p>(R10195)</p>	<ul style="list-style-type: none"> ■ Service monitor (LED A). ■ Check the LED from the slit.

2.2 Removal of Propeller Fan / Fan Motor

Procedure



Warning Be sure to wait 10 minutes or more after turning off all power supplies before disassembling work.

Step	Procedure	Points
<p>1. Removal of the top panel</p> <p>1 Remove the 2 screws of the top panel.</p>	<p style="text-align: right;">(R10197)</p>	
<p>2. Remove the front panel</p> <p>1 Remove the 7 screws of the front panel. There are 5 hooks in total of right and left. Lift the front panel and pull it out toward yourself.</p>	<p style="text-align: right;">(R10196)</p>	

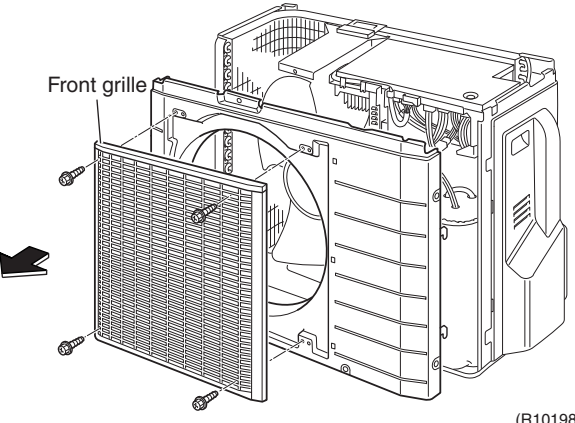
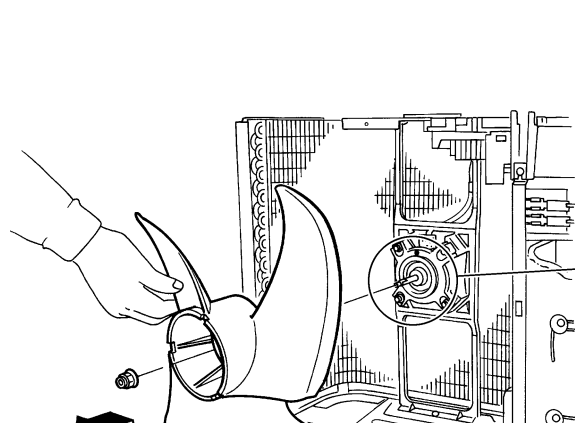
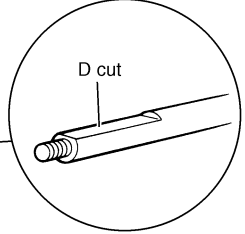
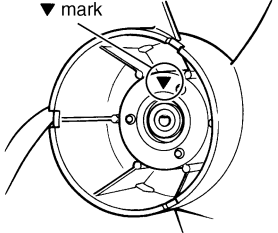
Step	Procedure	Procedure	Points
2	Remove the 4 screws to remove the front grille.		
3	Remove the 1 screw and remove the stop valve cover.		
3. Removal of the propeller fan			<ul style="list-style-type: none"> ■ When assembling, align the ▼ mark of the propeller fan and D cut of the motor shaft.
1	Remove the fan fixing nut and remove the propeller fan.		 

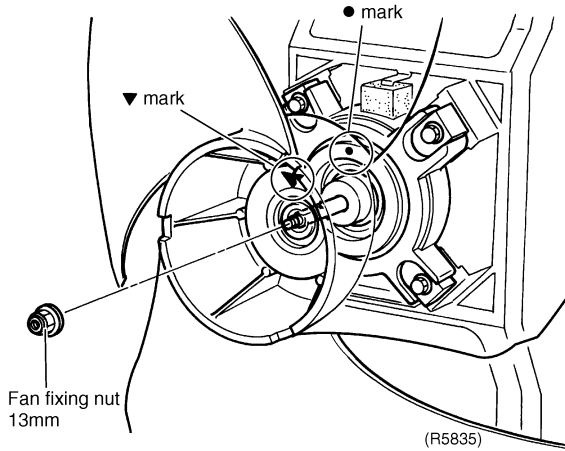
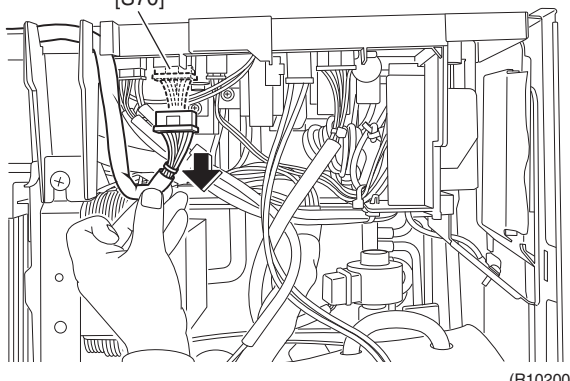
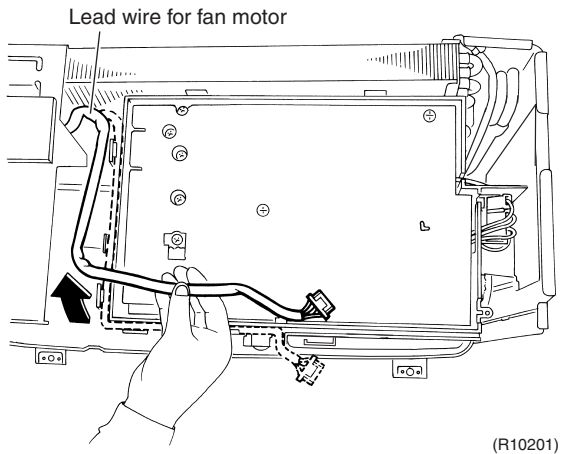
Step	Procedure	Points
	 <p>● mark</p> <p>▼ mark</p> <p>Fan fixing nut 13mm</p> <p>(R5835)</p>	<ul style="list-style-type: none"> ■ When assembling the fan motor, let the ● mark go upper. (The direction of the lead wire outlet.) ■ Remove the fan fixing nut with the 13mm spanner.
4. Removal of the fan motor	<p>1 Disconnect the fan motor connector [S70] from PCB.</p>  <p>[S70]</p> <p>(R10200)</p> <p>2 Detach the lead wire for fan motor and pass the lead wire downward through the opening.</p>  <p>Lead wire for fan motor</p> <p>(R10201)</p>	

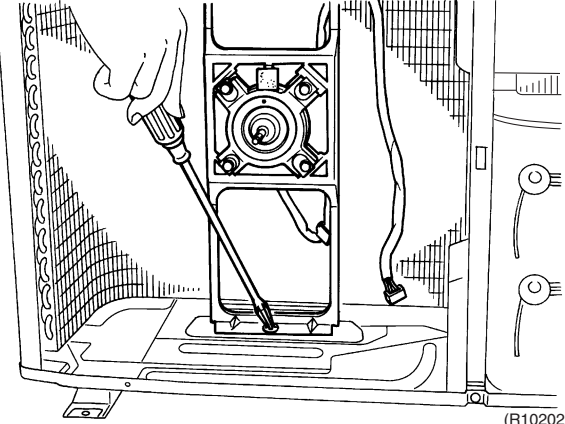
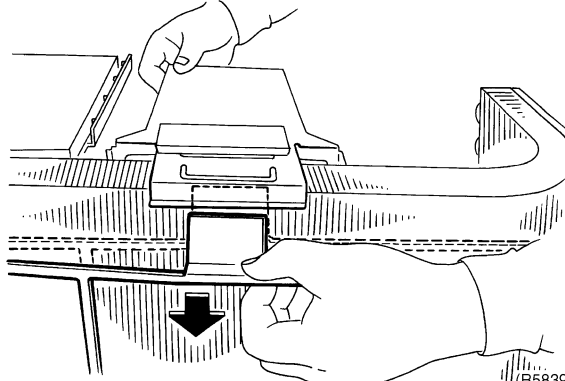
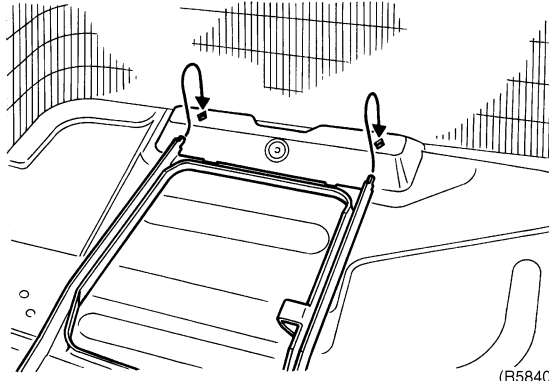
Step	Procedure	Procedure	Points
3	Remove the 1 screw of the fan motor fixing plate.	 <p>(R10202)</p>	
4	Detach the upper part of the fan motor fixing plate.	 <p>(R5839)</p>	<ul style="list-style-type: none"> ■ Heat exchanger fin
5	Fan motor fixing plate has the 2 hooks on lower part.	 <p>(R5840)</p>	

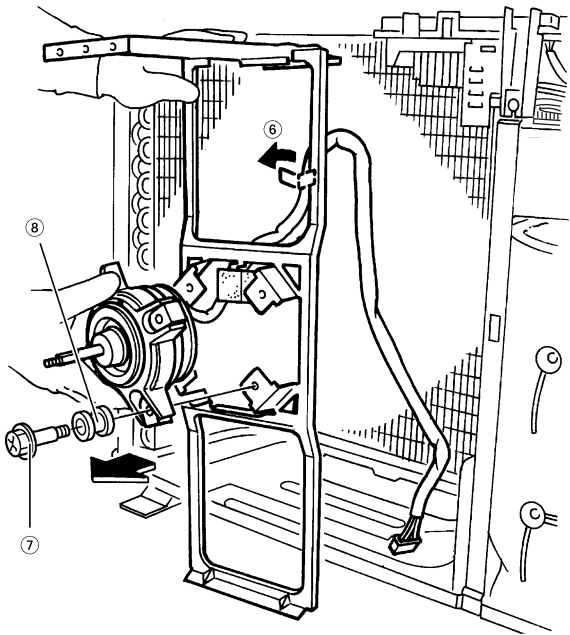
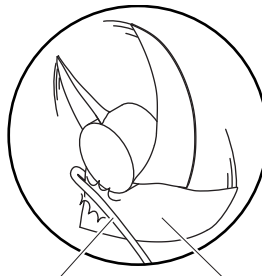
Step	Procedure	Procedure	Points
<p>6 Release the fixing hook for lead wire and detach the lead wire.</p> <p>7 Remove the 4 screws of the fan motor.</p> <p>8 Pull out the rubber vibration isolators sideward.</p>			 <p>Lead wire Propeller fan (R3249)</p> <ul style="list-style-type: none"> ■ When assembling, put the lead wire through the back of the motor so as not to be entangled with the propeller fan.



2.3 Removal of Electrical Box

Procedure

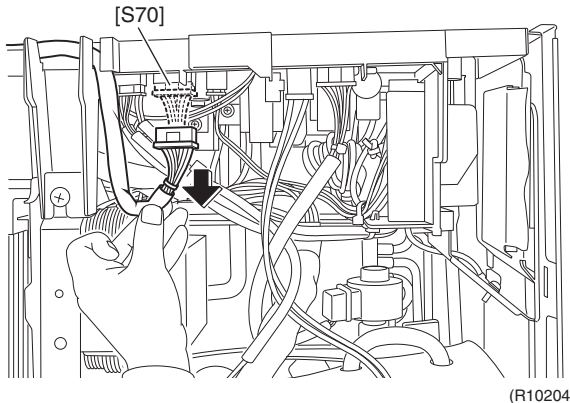
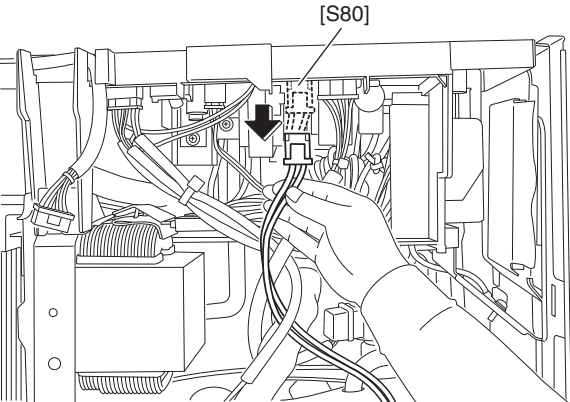
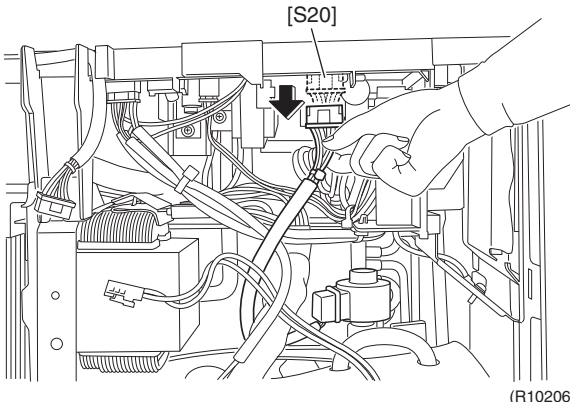

Warning Be sure to wait 10 minutes or more after turning off all power supplies before disassembling work.

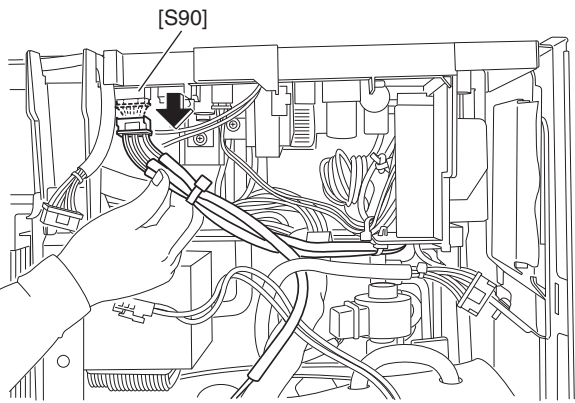
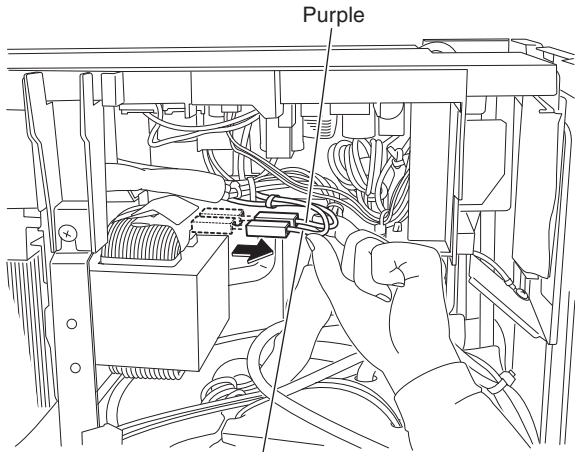
Step	Procedure	Points
1. Disconnect the wire harnesses of the PCB		<p>Preparation</p> <ul style="list-style-type: none"> Remove the front panel according to "Removal of Propeller Fan / Fan Motor."
1	<p>Disconnect the connector for fan motor [S70] from the PCB.</p> 	
2	<p>Disconnect the connector for four-way valve coil [S80].</p> 	
3	<p>Disconnect the connector for expansion valve coil [S20].</p> 	

Step	Procedure	Procedure	Points
4	Disconnect the connector for thermistor assembly [S90].	 <p>(R10207)</p>	<ul style="list-style-type: none"> ■ Thermistor assembly is in a set of 3 thermistors: Outdoor air, heat exchanger, and discharge pipe thermistors)
5	Disconnect the terminal from the reactor.	 <p>(R10208)</p>	
6	Disconnect the relay harness for compressor.	 <p>(R10209)</p>	

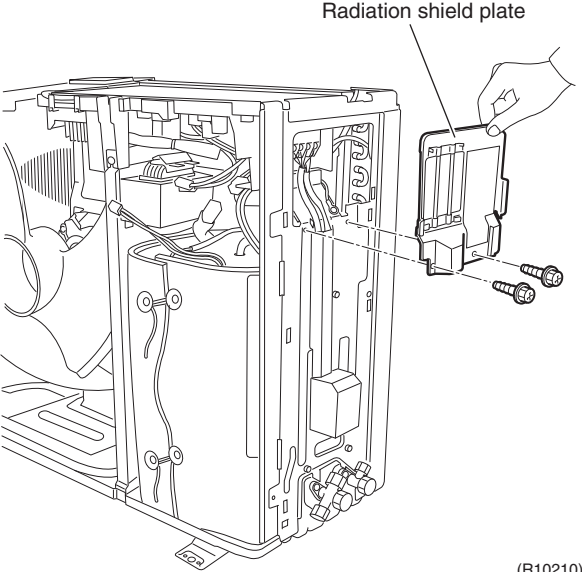
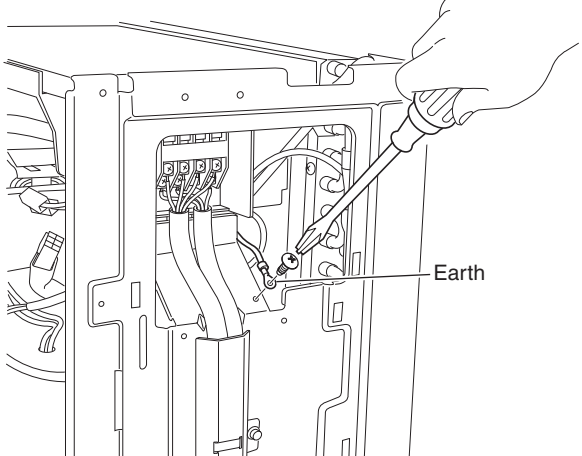
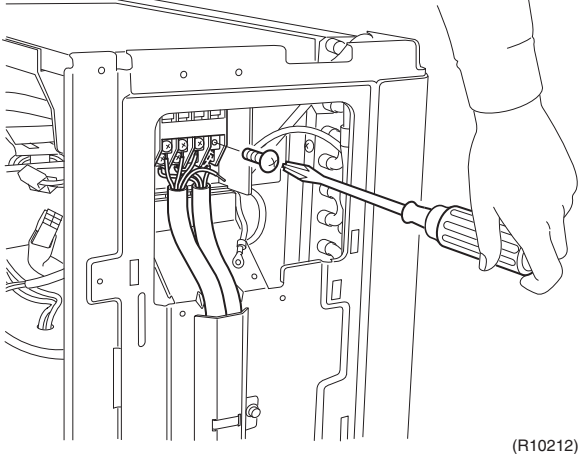
Step	Procedure	Points
2. Disconnect the power supply / connecting wiring		
1	<p>Remove the 2 screws of the radiation shield plate to remove.</p>  <p>(R10210)</p>	
2	<p>Remove the 1 screw of the ground wire.</p>  <p>(R10211)</p>	
3	<p>Disconnect all the connecting wires.</p>  <p>(R10212)</p>	

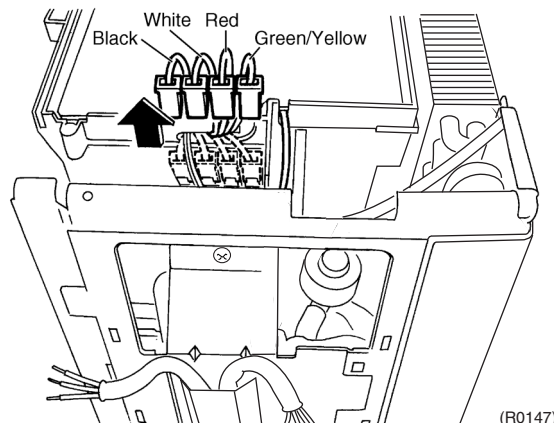
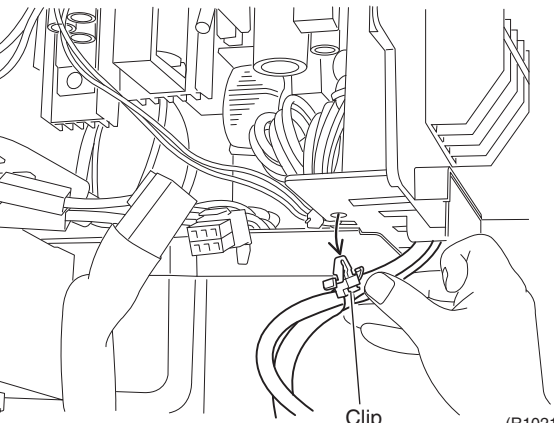
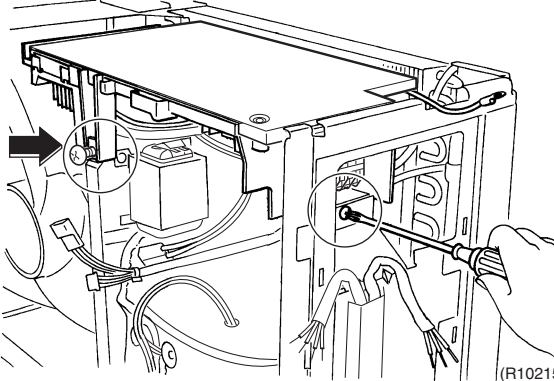
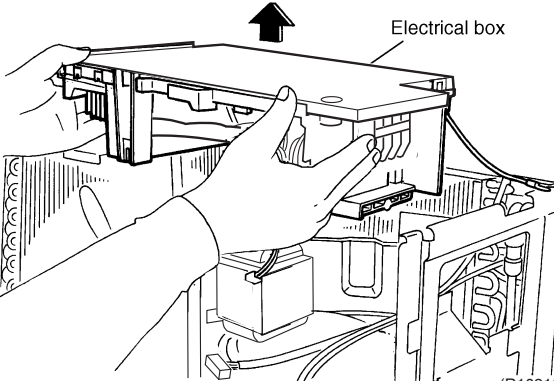
Step	Procedure	Procedure	Points
4	Disconnect the connectors: black - power supply white - power supply red - signal	 <p>(R0147)</p>	<ul style="list-style-type: none"> Black: power supply White: power supply Red: signal
5	Undo the clip for the thermistor assembly fixed to the electrical box.	 <p>Clip (R10214)</p>	<ul style="list-style-type: none"> The clip is push-mount type.
6	Remove the 1 screw in front and 1 screw on the right of the electrical box.	 <p>(R10215)</p>	
7	Lift the electrical box to remove it.	 <p>Electrical box (R10216)</p>	

2.4 Removal of PCB

Procedure

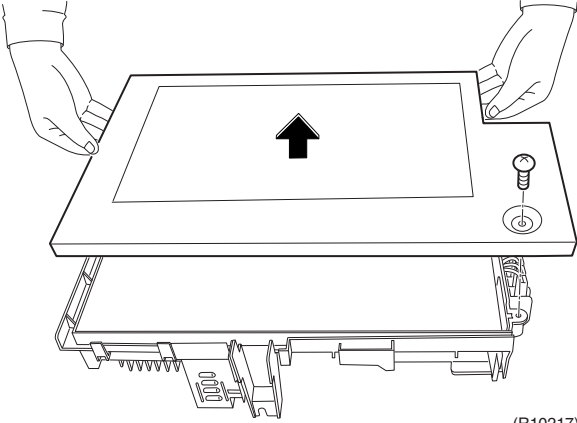
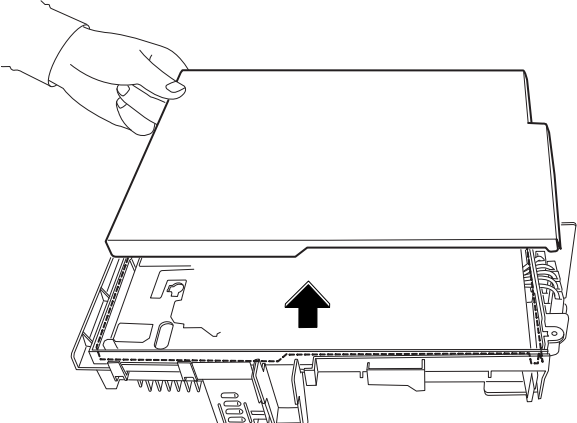
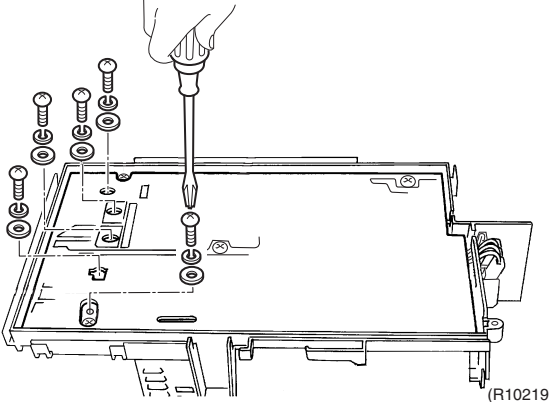

Warning Be sure to wait 10 minutes or more after turning off all power supplies before disassembling work.

Step	Procedure	Points
1	<p>Remove the 1 screw of the electrical box (cover). Lift the electrical (cover) and remove.</p>  <p style="text-align: right;">(R10217)</p>	
2	<p>Lift the insulation sheet and remove.</p>  <p style="text-align: right;">(R10218)</p>	
3	<p>Remove the 5 screws for the PCB or the radiation fin.</p>  <p style="text-align: right;">(R10219)</p>	<p>Preparation</p> <ul style="list-style-type: none"> ■ Remove the electrical box according to "Removal of Electrical Box." ■ The control PCB is in upside down. ■ PbF (Pb free brazing) is adopted. When replacing, use a exclusive solder and soldering iron.

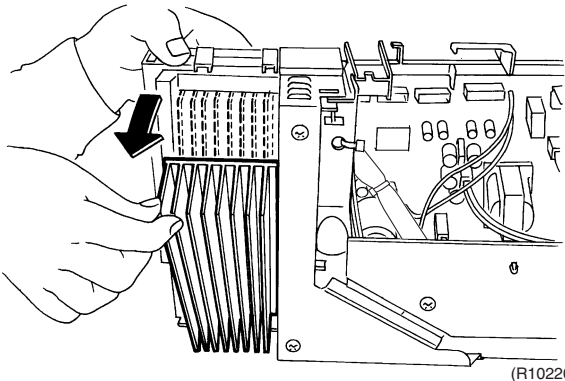
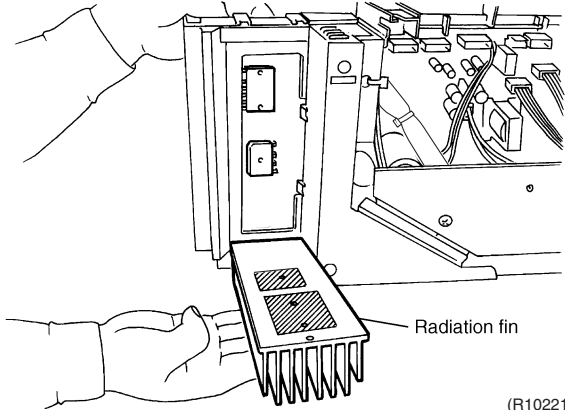
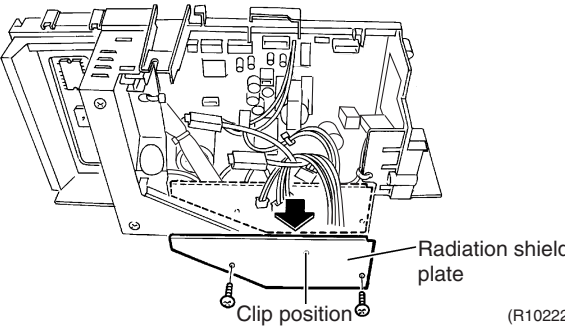
Step	Procedure	Procedure	Points
4	Remove the radiation fin from the PCB.	 <p>(R10220)</p>  <p>Radiation fin</p> <p>(R10221)</p>	<ul style="list-style-type: none"> ■ In working, be careful not to break the PCB with the excessive force because the PCB and the radiation fin are adhered to one another ■ When assembling, make sure to use the silicon material. Silicon material Part No.: 1172698
5	Remove the 2 screws and 1 clip to remove the radiation shield plate.	 <p>Radiation shield plate</p> <p>Clip position</p> <p>(R10222)</p>	

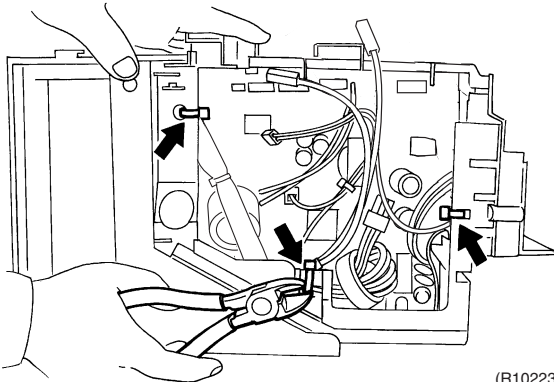
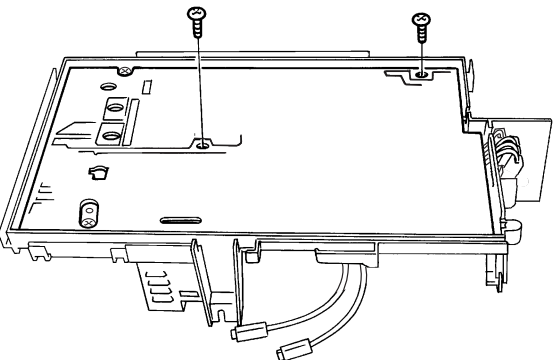
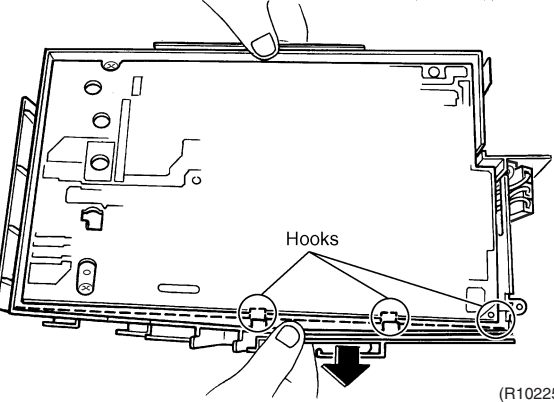
Step		Procedure	Points
6	Cut the 3 fixing clamps for the wire harnesses.	 <p>(R10223)</p>	
7	Remove the 2 fixing screws of the PCB.	 <p>(R10224)</p>	
8	Raise the PCB toward yourself and undo the 3 hooks of the electrical box.	 <p>(R10225)</p>	

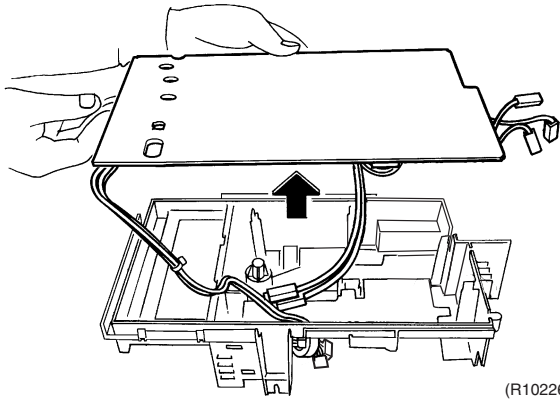
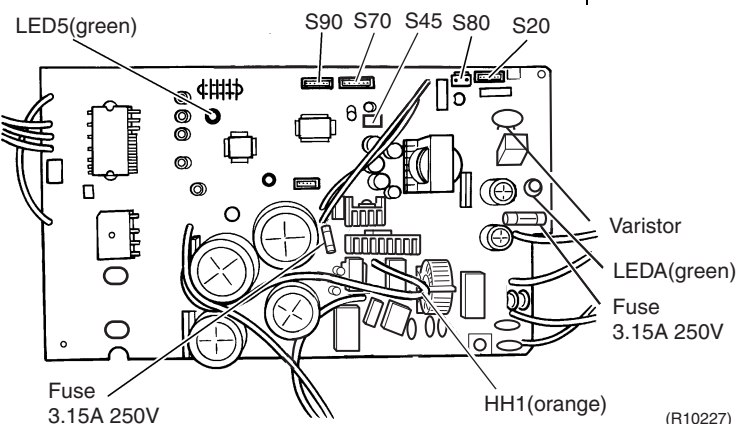
Step		Procedure	Points
9	Remove the PCB from the electrical box.	 <p>(R10226)</p>	
10	Names of parts of PCB.	 <p>(R10227)</p>	<p>S20 : Expansion valve S45 : Thermal fuse S70 : Fan motor S80 : Four way valve S90 : Thermistor (outdoor air / heat exchanger / discharge pipe)</p>

2.5 Removal of Sound Blanket

Procedure

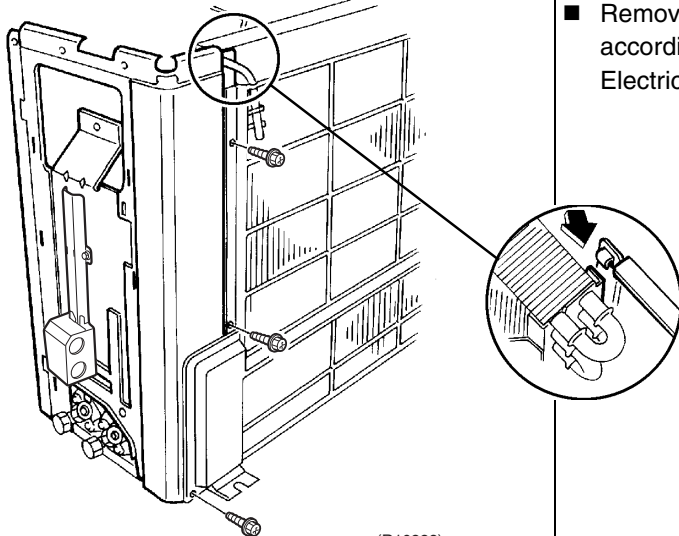
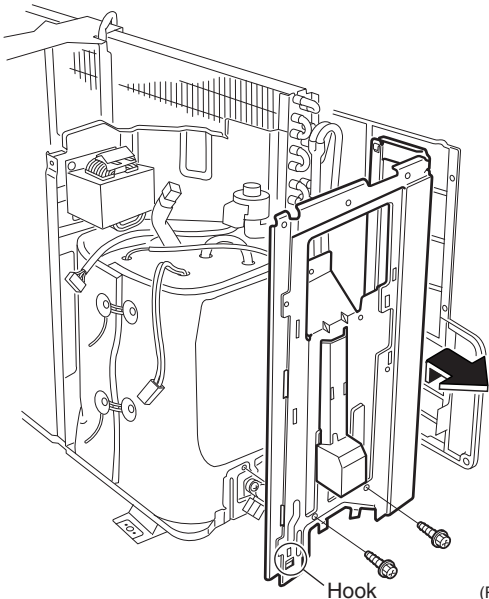

Warning Be sure to wait 10 minutes or more after turning off all power supplies before disassembling work.

Step	Procedure	Points
1. Removal of the right side panel		<p>Preparation</p> <ul style="list-style-type: none"> Remove the electrical box according to "Removal of Electrical Box."
1	<p>Remove the 3 screws on the back side of the right side panel.</p>	 <p>(R10228)</p>
2	<p>Remove the 2 screws on the right and slide the panel to undo the lower hook.</p>	 <p>Hook</p> <p>(R10229)</p>

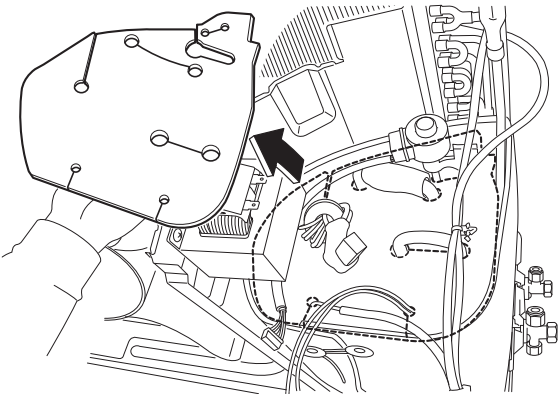
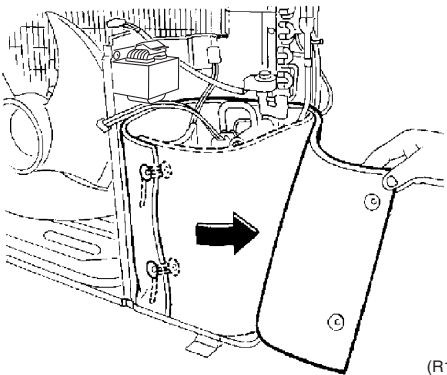
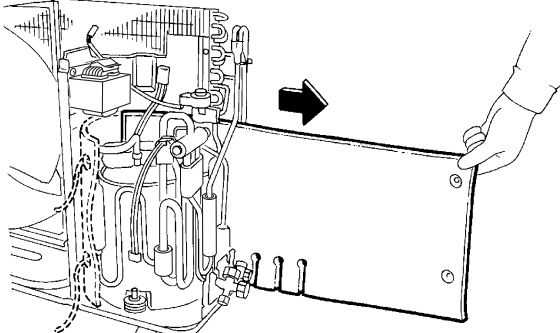
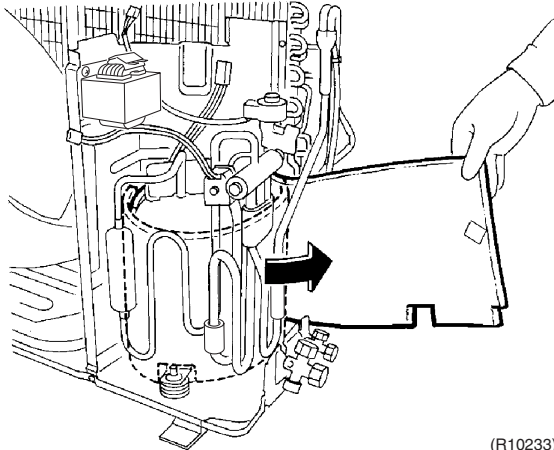
Step	Procedure	Points	
2.	Removal of the sound blanket		
1	Lift the sound blanket (top) to remove it.	<ul style="list-style-type: none"> ■ Since the piping ports on the sound blanket are torn easily, remove the blanket carefully. 	
2	Undo the fixing strings of the sound blanket (outer body).		 <p style="text-align: right;">(R10230)</p>
3	Open the sound blanket (outer body) and pull it out.		 <p style="text-align: right;">(R10231)</p>
4	Open the sound blanket (inner body) and pull it out.		 <p style="text-align: right;">(R10232)</p>  <p style="text-align: right;">(R10233)</p>

2.6 Removal of Thermistor Assembly

Procedure



Warning Be sure to wait 10 minutes or more after turning off all power supplies before disassembling work.

Step	Procedure	Procedure	Points
1	The figure shows the arrangement of the thermistors.	<p>(R10234)</p>	<p>Preparation</p> <ul style="list-style-type: none"> Remove the thermistor assembly according to "Removal of Electrical Box."
2	Remove the 3 screws on the back side of the right side panel and detach the outdoor air thermistor.	<p>(R10235)</p>	
3	Remove the 2 screws on the right and slide the panel to undo the lower hook.	<p>(R10236)</p>	

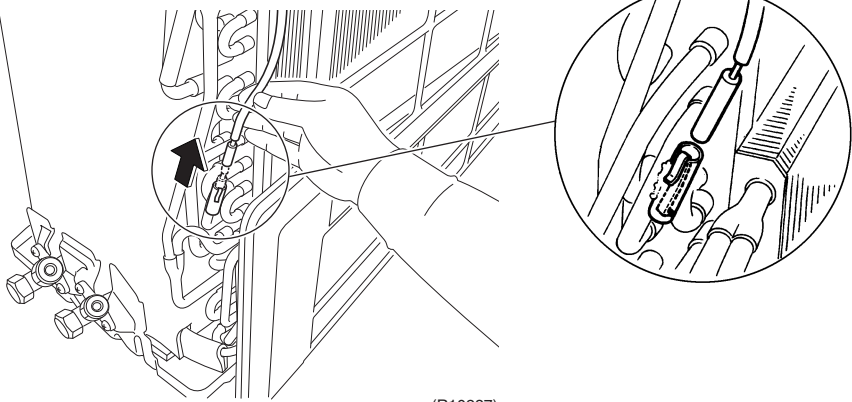
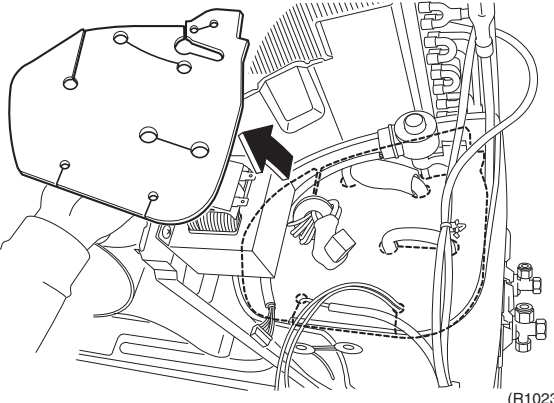
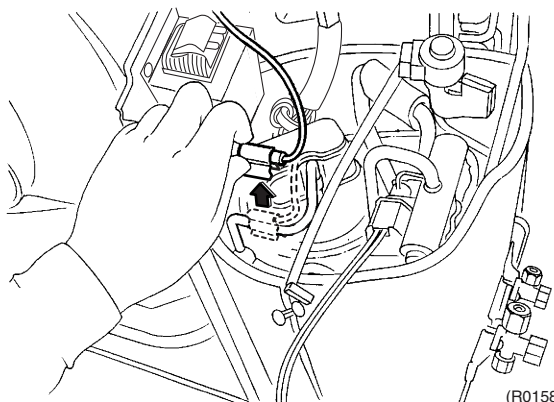
Step	Procedure	Procedure	Points
4	Detach the heat exchanger thermistor.	 <p>(R10237)</p>	<ul style="list-style-type: none"> ■ Be careful not to loosen the clip for the thermistor.
5	Lift the sound blanket (top) to remove it.	 <p>(R10238)</p>	<ul style="list-style-type: none"> ■ Since the piping ports on the sound blanket are torn easily, remove the blanket carefully.
6	Detach the discharge pipe thermistor.	 <p>(R0158)</p>	<ul style="list-style-type: none"> ■ Detach the discharge pipe thermistor while opening the thermistor fixing clip. ■ Be careful not to loosen the fixing clip for the discharge pipe thermistor. ■ Meet the edge of the thermistor and clip when assembling.

2.7 Removal of Reactor / Partition Plate

Procedure

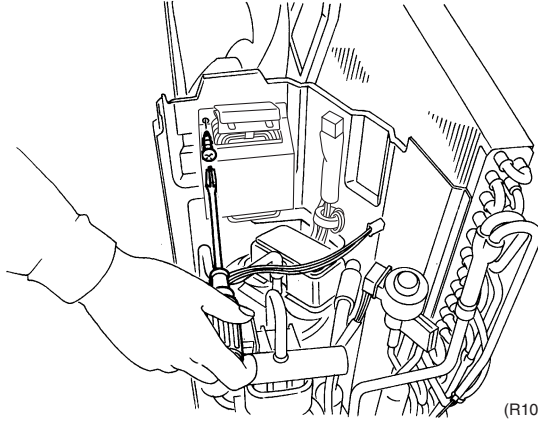
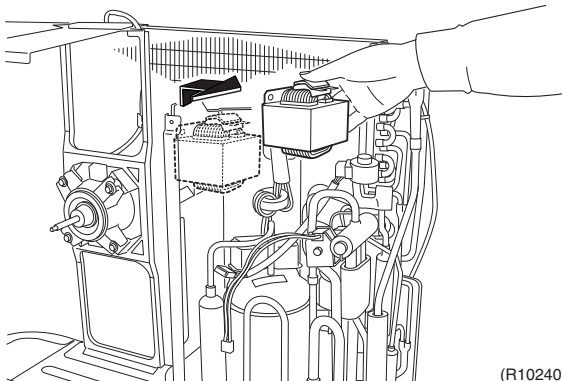
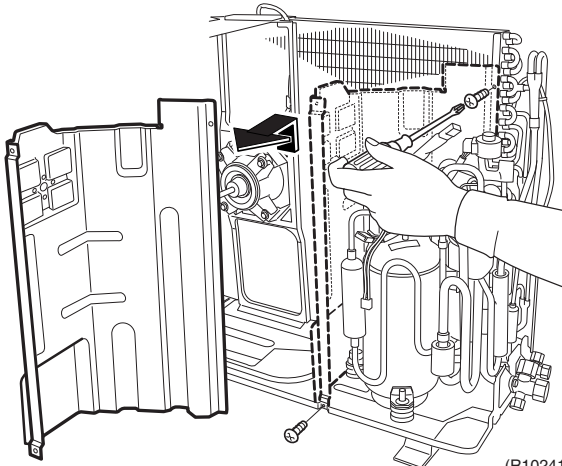

Warning Be sure to wait 10 minutes or more after turning off all power supplies before disassembling work.

Step	Procedure	Points
<p>1. Removal of the reactor</p> <p>1 Remove the 1 screw and lift the reactor to remove it.</p>	 <p>(R10239)</p>  <p>(R10240)</p>	<p>Preparation</p> <ul style="list-style-type: none"> ■ Remove the sound blanket according to "Removal of Sound Blanket." ■ The reactor can be detached by removing only 1 screw.
<p>2. Removal of the partition plate</p> <p>2 Remove the 2 screws and lift the plate to remove it.</p>	 <p>(R10241)</p>	

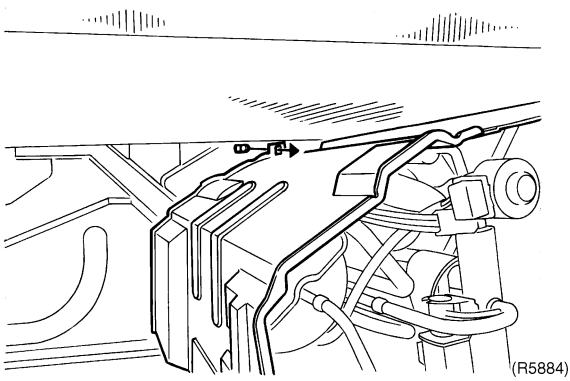
Step	Procedure	Points
	 <p>(R5884)</p>	<ul style="list-style-type: none">■ When assembling, make sure to catch the lower hook of the partition plate.

2.8 Removal of Four Way Valve

Procedure

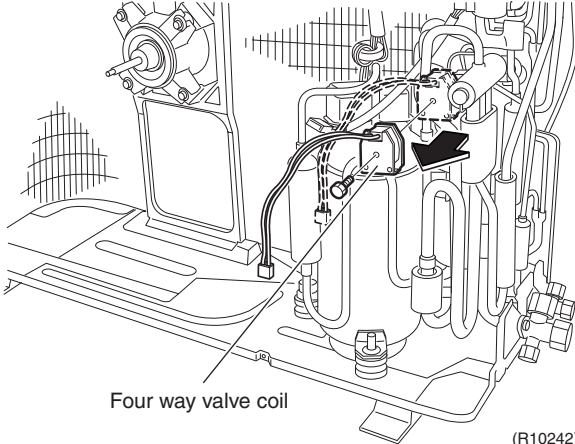
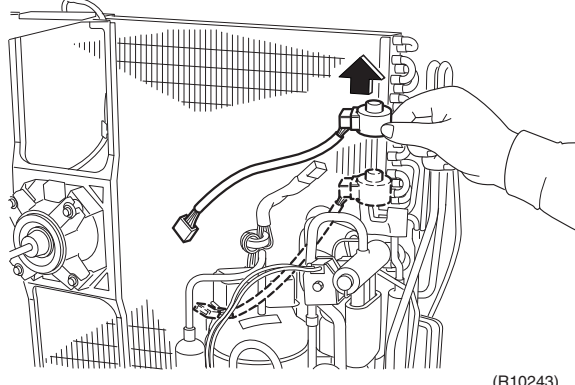
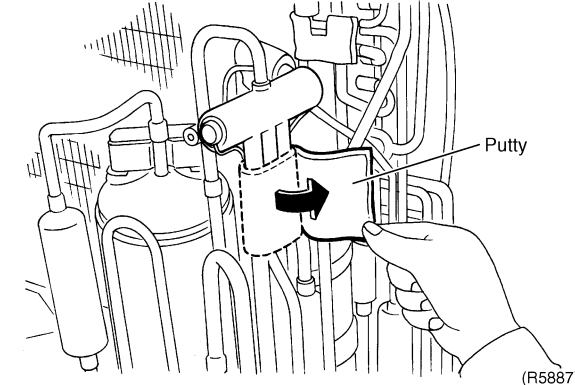

Warning Be sure to wait 10 minutes or more after turning off all power supplies before disassembling work.

Step	Procedure	Points
1. Removal of the peripheral parts		<p>Preparation</p> <ul style="list-style-type: none"> Remove the sound blanket according to "Removal of Sound Blanket."
1	<p>Remove the 1 screw of the four-way valve coil.</p>  <p>Four way valve coil</p> <p>(R10242)</p>	
2	<p>Remove the expansion valve coil.</p>  <p>(R10243)</p>	
3	<p>Remove the putty.</p>  <p>Putty</p> <p>(R5887)</p>	

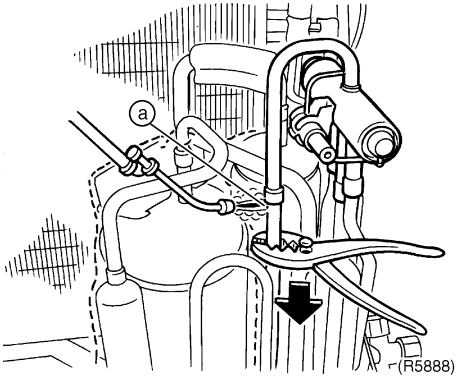
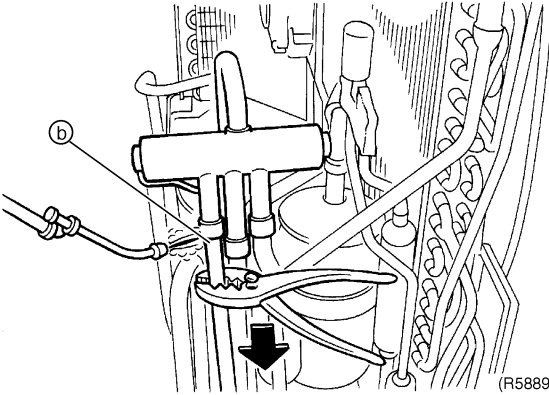
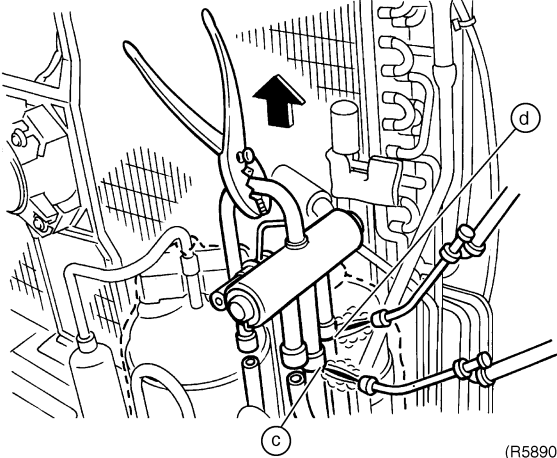
Step	Procedure	Points
<ul style="list-style-type: none"> ■ Provide a protective sheet or a steel plate so that the brazing flame cannot influence peripheries. ■ Before working, make sure that the refrigerant is empty in the circuit. ■ Be sure to apply nitrogen replacement when heating up the brazed part. 		<p>Cautions for restoration</p> <ol style="list-style-type: none"> 1. Restore the piping by non-oxidation brazing. In case of you cannot use the nitrogen gas, restore as quickly as possible. 2. It is required to prevent the carbonization of the oil inside the four way valve and the deterioration of the gaskets affected by heat. For the sake of this, wrap the four way valve with wet cloth and provide water so that the cloth will not be dried and avoid excessive heating. (Keep below 120°C)
<p>2. Removal of four-way valve</p> <ol style="list-style-type: none"> 1 Heat up the 4 brazed parts of the four-way valve. Remove it in the order of (a), (b), (c), (d). 2 Heat up the brazed part and pull out the piping side with pliers. <p>Warning Ventilate when refrigerant leaks during the work. If refrigerant contacts fire, it will cause toxic gas.</p> <p>Caution Be careful not to get yourself burnt with the pipes and other parts that are heated by the gas welding rod.</p> <p>Caution From the viewpoint of global environment protection, do not discharge the refrigerant gas in the atmosphere. Make sure to recover the refrigerant gas with a recovery system.</p>	 	<ul style="list-style-type: none"> ■ Be careful so as not to break the pipes by pressing it excessively by pliers when withdrawing it. <p>In case of the difficulty with gas brazing machine</p> <ol style="list-style-type: none"> 1. Disconnect the brazed part where is easy to disconnect and restore. 2. Cut pipes on the main unit by a miniature copper tube cutter in order to make it easy to disconnect. <p>i Note: Do not use a metal saw for cutting pipes or sawdust will enter the circuit.</p>

2.9 Removal of the Expansion Valve

Procedure



Warning Be sure to wait 10 minutes or more after turning off all power supplies before disassembling work.

Step	Procedure	Points
<p>1. Remove the peripheral parts</p> <ul style="list-style-type: none"> • Four-way valve coil • Expansion valve coil • Putty <p>and so on so as not to be damaged by the brazing flame.</p>	<p style="text-align: right;">(R10244)</p>	<p>Preparation</p> <ul style="list-style-type: none"> ■ Remove the sound blanket according to "Removal of Sound Blanket." ■ When assembling, make sure to catch the hook of the expansion valve coil as before.
<p>1 Remove the four-way valve coil.</p> <p>2 Remove the expansion valve coil.</p>	<p style="text-align: right;">(R10245)</p>	<p>Warning</p> <p>Ventilate when refrigerant leaks during the work . If refrigerant contacts fire, it causes toxic gas.</p> <p>Caution</p> <p>Be careful not to burn yourself with the pipes and other parts that are heated by the gas welding rod.</p>
<p>3 Remove the putty.</p>	<p style="text-align: right;">(R5893)</p>	<p>Caution</p> <p>From the viewpoint of global environment protection, do not discharge the refrigerant gas in the atmosphere. Make sure to recover the refrigerant gas with the recovery system.</p>

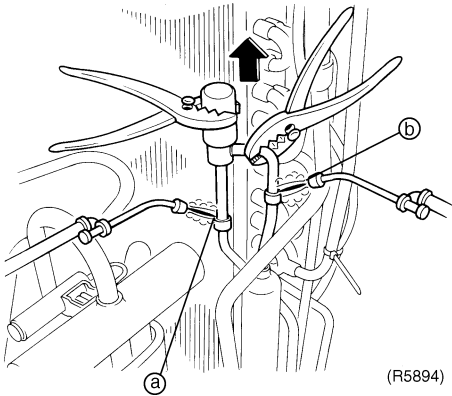
Step	Procedure	Points		
<ul style="list-style-type: none"> ■ Before working, make sure that the refrigerant is empty in the circuit. ■ Be sure to apply nitrogen replacement when heating up the brazed part. 		<ul style="list-style-type: none"> ■ Be careful so as not to burn the heat exchanger fin. ■ When assembling, make sure to catch the hook of the expansion valve coil as before. 		
2. Remove the expansion valve.				
1			Remove the 2 brazed parts in the order of (a), (b).	

2.10 Removal of Compressor

Procedure



Warning Be sure to wait 10 minutes or more after turning off all power supplies before disassembling work.

Step	Procedure	Points
1. Removal of the peripheral parts		<p>Preparation</p> <ul style="list-style-type: none"> Remove the sound blanket according to "Removal of Sound Blanket".
1 Remove the terminal cover.	<p>(R10246)</p>	<ul style="list-style-type: none"> Be careful so as not to burn the compressor terminals or the name plate.
2 Detach the lead wires for compressor and overload protector.	<p>(R10247)</p>	<p>Make a note.</p> <p>(R10249)</p>
3 Remove the protecting bushing for the lead wire.	<p>(R5897)</p>	
4 Remove the 3 fixing nuts for compressor.	<p>(R10248)</p>	

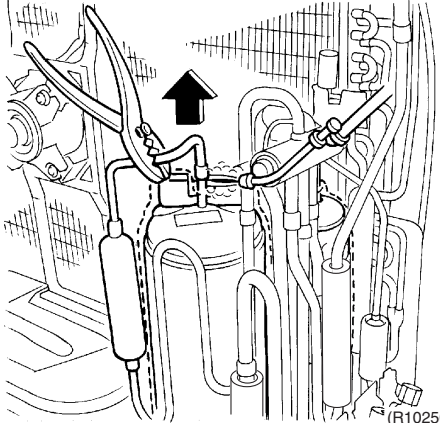
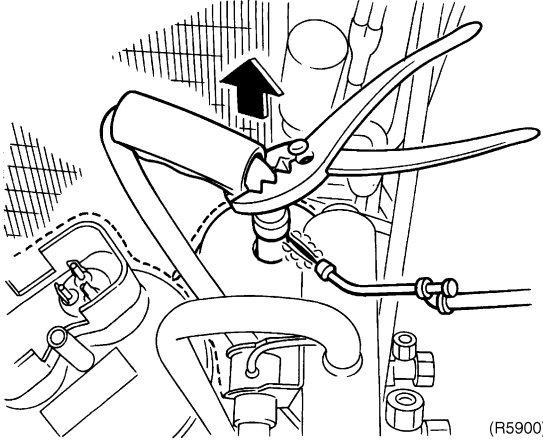
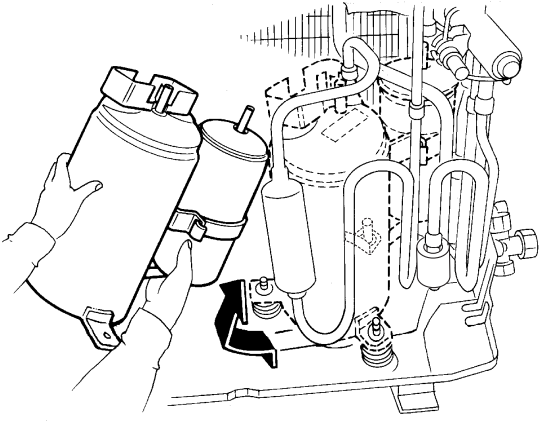
Step	Procedure	Points
<ul style="list-style-type: none"> ■ Provide a protective sheet or a steel plate so that the brazing flame cannot influence peripheries. ■ Before working, make sure that the refrigerant is empty in the circuit. ■ Be sure to apply nitrogen replacement when heating up the brazed part. 	 <p style="text-align: right;">(R10250)</p>	<p>Warning Ventilate when refrigerant leaks during the work . If refrigerant contacts fire, it will cause toxic gas.</p> <p>Caution Be careful not to burn yourself with the pipes and other parts that are heated by the gas welding rod.</p> <p>Cautions for restoration</p> <ol style="list-style-type: none"> 1. Restore the piping by non-oxidation brazing. In case of you cannot use the nitrogen gas, restore as quickly as possible. 2. It is required to prevent the carbonization of the oil inside the four-way valve and the deterioration of the gaskets affected by heat, so wrap the four-way valve with a wet cloth and provide water to ensure that the cloth does not dry out, and to prevent excessive heating. (Keep below 120°C)
2. Removal of the compressor		
1	Disconnect the brazing part of the compressor on the discharge side.	
2	Heat up and disconnect the brazing part on the suction side.	
3	Lift up and remove the compressor. <p>Caution From the viewpoint of global environment protection, do not discharge the refrigerant gas in the atmosphere. Make sure to recover the refrigerant gas with the recovery system.</p>	<p>■ Be careful not to break the pipes when removing them by applying too much pressure with the pliers. by pressing it excessively by pliers when withdrawing it.</p>
	 <p style="text-align: right;">(R5900)</p>	
	 <p style="text-align: right;">(R10251)</p>	
		<p>In case of the difficulty with gas brazing machine</p> <ol style="list-style-type: none"> 1. Disconnect the brazed part which is easy to disconnect and restore. 2. Cut pipes on the main unit by a miniature copper tube cutter in order to make it easy to disconnect.
		<p>Note: Do not use a metal saw for cutting pipes or sawdust will enter the circuit.</p>

Part 8

Additional Information

1. Additional Information	232
1.1 Trial Operation.....	232
1.2 Field Setting	233
1.3 Application of Silicon Grease to a Power Transistor and a Diode Bridge.....	234

1. Additional Information

1.1 Trial Operation

1.1.1 Trial Operation and Testing

1. Measure the supply voltage and make sure that it falls in the specified range.
2. Trial operation should be carried out in either cooling or heating mode.
3. Operate the unit in accordance with the operation manual to check that it operates normally.
 - Even when the air conditioner is not operating, it consumes some electric power. If the customer is not going to use the unit soon after it is installed, turn off the breaker to avoid wasting electricity.

For Heat pump

In cooling mode, select the lowest programmable temperature; in heating mode, select the highest programmable temperature.

- Trial operation may be disabled in either mode depending on the room temperature.
- After trial operation is complete, set the temperature to a normal level.
(26°C to 28°C (78°F to 82°F) in cooling mode, 20°C to 24°C (68°F to 75°F) in heating mode)
- For protection, the system disables restart operation for 3 minutes after it is turned off.

1.1.2 Trial operation from Remote Controller

- (1) Hold the “CLOCK” button for 5 seconds.
(The matrix display will appear on the remote controller.)
- (2) Display “**SETTING**
1. TEST” on the matrix display of the remote controller and press the “CLOCK” button.
- (3) “**7**” will be displayed and the unit will enter test run mode.
- (4) Press the corresponding mode button for the trial operation.
 - Trial operation will stop automatically after around 30 minutes.
Press the ON/OFF button to stop.

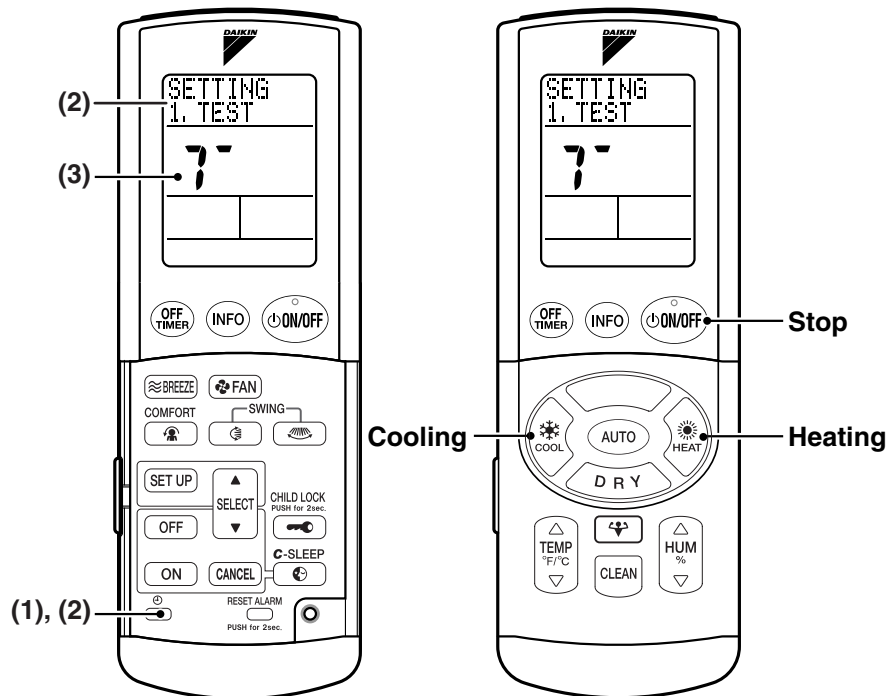

(4) Mode for trial operation

(R10190)

(R10191)

1.2 Field Setting

1.2.1 How to set the different addresses

When 2 indoor units are installed in 1 room, the 2 wireless remote controllers can be set for different addresses.

- 1) Remove the front grille. (3 screws)
- 2) Cut the address jumper "JA".
(See Fig. 1)

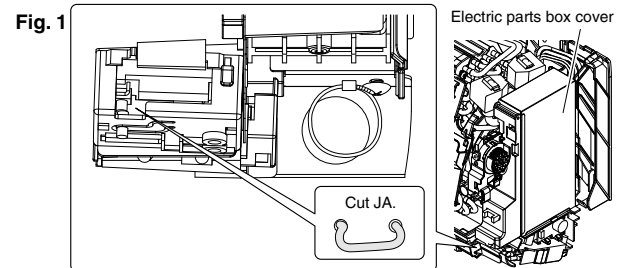

- 3) Remove the remote controller lid and cut the address jumper "J4".
(See Fig. 2)

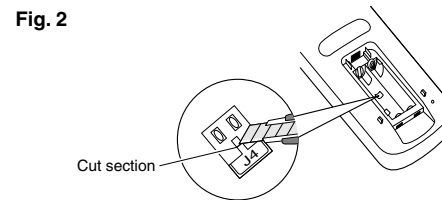

(R10192)

1.2.2 Jumper Setting

Jumper (On indoor control PCB)	Function	When connected (factory set)	When cut
JC	Power failure recovery function	Auto-restart	Unit does not resume operation after recovering from a power failure. Timer ON-OFF settings are cleared.
JB	Fan speed setting when compressor is OFF on thermostat. (effective only at cooling operation)	Fan speed setting ; Remote controller setting	Fan rpm is set to "0" <Fan stop>

1.3 Application of Silicon Grease to a Power Transistor and a Diode Bridge

Applicable Models

All outdoor units using inverter type compressor for room air conditioner.

When the printed circuit board of an outdoor unit is replaced, it is required that silicon grease (*1) is applied to the heat radiation part (the contact point to the heat radiation fin) of the power transistor and diode bridge.

*1: Parts number of the silicon grease – 1172698 (Drawing number 3FB03758-1)

Details

The silicon grease is an essential article for encouraging the heat radiation of the power transistor and the diode bridge. Applying the paste should be implemented in accordance with the following instruction.

Remark: There is the possibility of failure with smoke in case of bad heat radiation.

- Completely wipe off the old silicon grease on a heat radiation fin.
- Evenly apply the silicon grease to the whole unit.
- Do not have any foreign object such as solder or paper waste between the power transistor, the diode bridge and the heat radiation fin.
- Firmly tighten the screws of the power transistor and the diode bridge, and ensure contact to the heat radiation fin without any gap.

<Example>

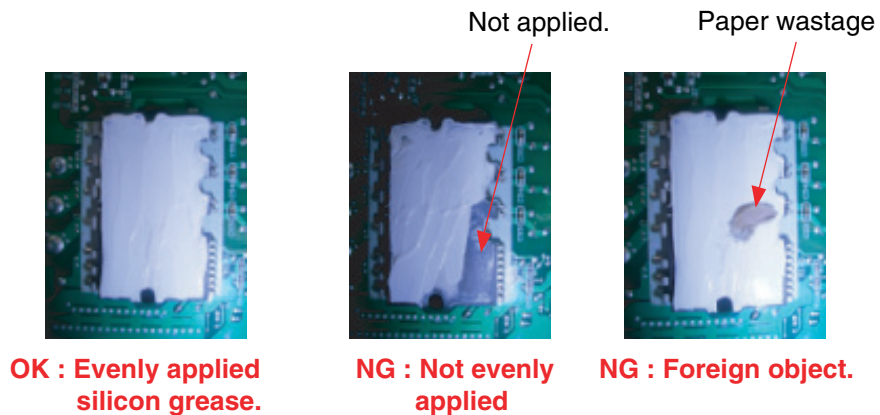
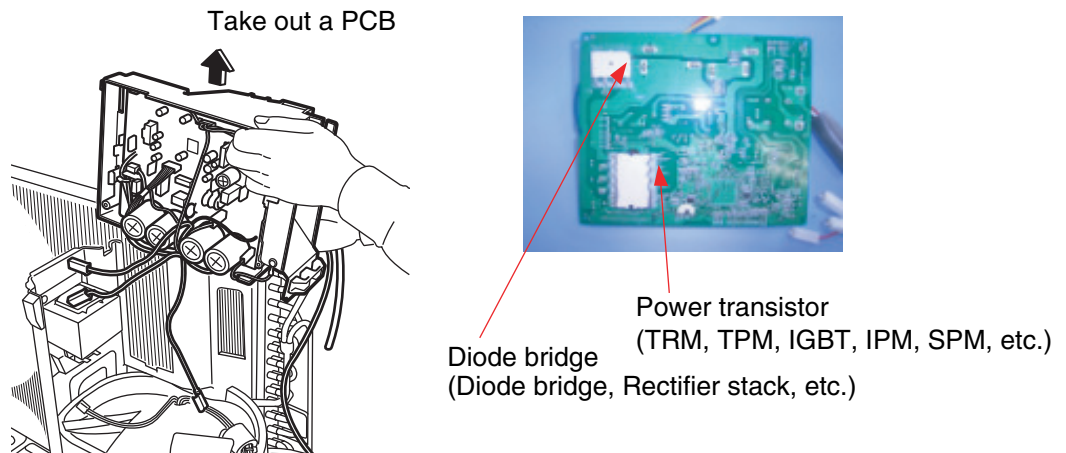

(R9056)

Part 9

Appendix

1. Piping Diagrams.....	236
1.1 Indoor Units.....	236
1.2 Outdoor Units.....	236
2. Wiring Diagrams.....	237
2.1 Indoor Units.....	237
2.2 Outdoor Units.....	237

1. Piping Diagrams

1.1 Indoor Units

FTXG09/12/15HVJU

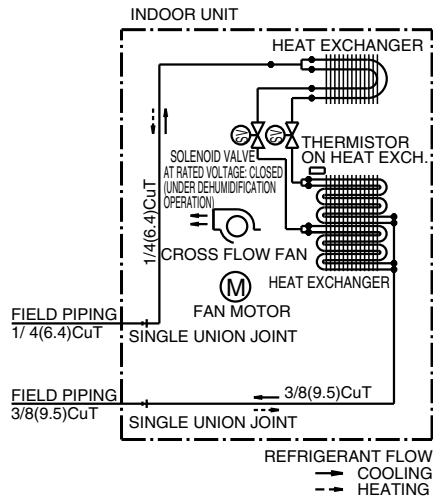

4D061001

1.2 Outdoor Units

RXG09/12/15HVJU

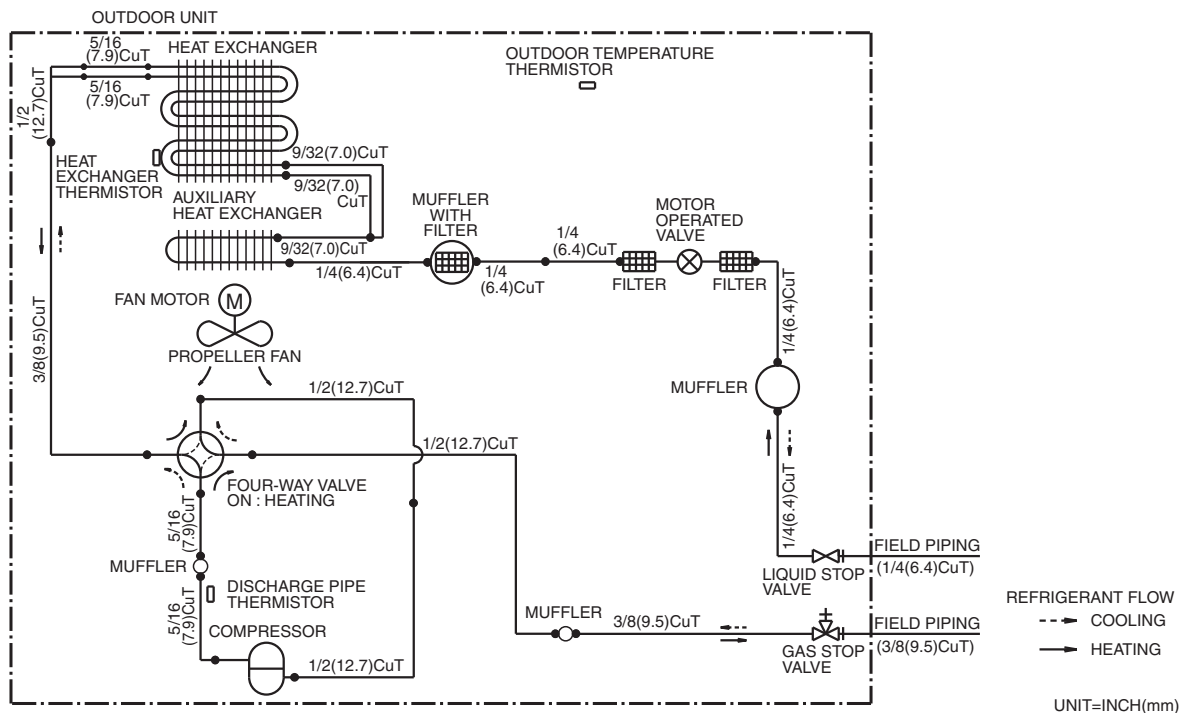

3D062171A

2. Wiring Diagrams

2.1 Indoor Units

FTXG09/12/15HVJU

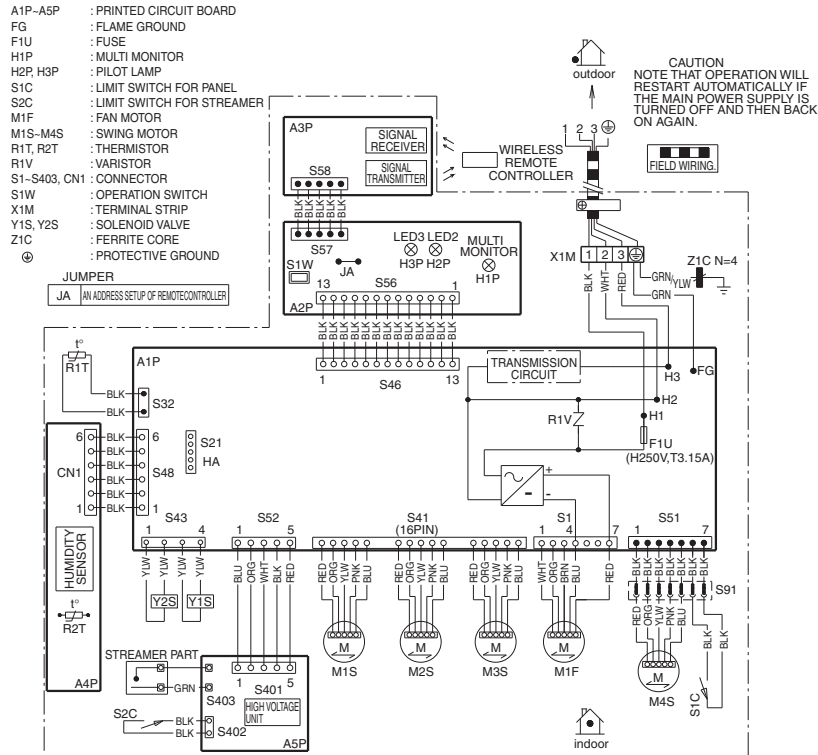

3D052768C

2.2 Outdoor Units

RXG09/12/15HVJU

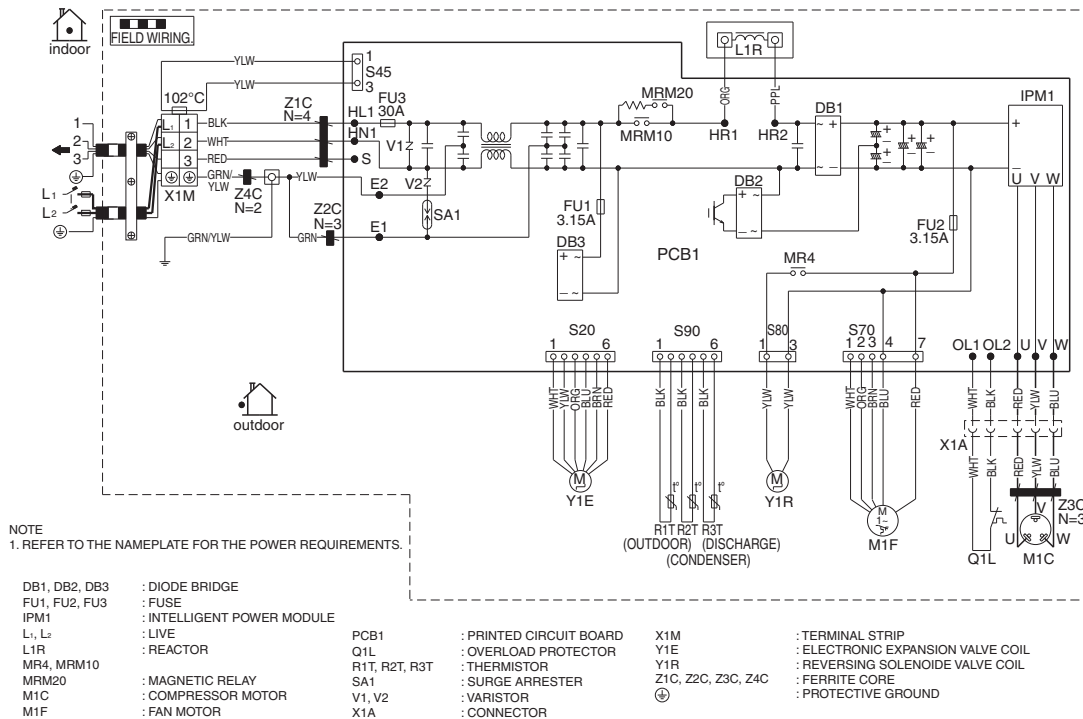

3D061486

Index

Symbols

"inverter checker" check.....	145
"sarara" drying operation.....	14, 73

Numerics

1/f fluctuation.....	20
24-hour on/off timer.....	30
3-d airflow.....	22

A

a1.....	96
a5.....	97
a6.....	99
abnormal temperature in electrical box.....	126
address setting jumper.....	8
adjusting airflow direction.....	77
ah.....	101
air filters.....	156
airflow rate.....	77
auto operation.....	75
automatic airflow.....	34
automatic defrosting.....	46
automatic operation.....	18
auto-restart.....	8

B

bearing.....	194
--------------	-----

C

c4.....	103
c7.....	104
c9.....	103
cc.....	105
centralized control.....	8
check	
"inverter checker" check.....	145
discharge pressure check.....	147
electronic expansion valve check.....	148
four way valve for dehumidification check.....	153
four way valve performance check.....	152
humidity sensor check.....	151
indoor unit pcb output check.....	149
installation condition check.....	142
main circuit electrolytic capacitor check.....	143
main circuit short check.....	151
outdoor fan system check (dc motor).....	142
power supply waveform check.....	143
power transistor check.....	146
refrigerant system check.....	144
rotating pulse input on outdoor unit pcb check.....	150

thermistor resistance check.....	141
check no.11.....	143
check no.12.....	144
check no.14.....	145
check no.15.....	146
check no.16.....	147
check no.17.....	148
check no.18.....	149
check no.2.....	141
check no.23.....	150
check no.27.....	151
check no.29.....	151
check no.3.....	142
check no.31.....	152
check no.32.....	153
check no.5.....	142
check no.8.....	143
child proof lock.....	81
cn1.....	8
combination of on timer and off timer.....	31
comfort airflow.....	78
comfort airflow mode.....	19
comfort sleep operation.....	16, 80
communication circuit abnormality.....	135
compressor.....	228
compressor lock.....	111
compressor overload.....	110
compressor sensor system abnormality.....	120
compressor start up protection.....	39
connectors.....	8, 10
control for abnormally high discharge temperature.....	52
control pcb (indoor).....	8, 180
control pcb (outdoor).....	10
control when frequency is changed.....	49
control when starting.....	48
cooling breeze operation.....	20, 78
cooling operation.....	73
countdown off timer.....	31

D

dc current sensor abnormality.....	123
dc fan lock.....	112
dc voltage abnormality.....	123
defrost control.....	46
dehumidifying four way valve.....	175
dehumidifying four way valve coil.....	185
deodorizing filter for streamer.....	158
deodorizing performance.....	29
description of operation.....	12
dew prevention.....	44

diagnosis mode	32
different addresses	233
diode bridge	234
discharge pipe temperature control	45, 117
discharge pipe thermistor	124, 221
discharge pressure check	147
discharge temperature, abnormally high	52
display pcb	8, 182
draft prevention	36
draftless operation	19
drain hose	186
drain plug	186
drip proof cover	177, 204
dry cooling operation	15
E	
e1	109
e5	110
e6	111
e7	112
e8	113
ea	115
electrical box	126
electrical box (indoor)	174
electrical box (outdoor)	210
electronic expansion valve check	148
electronic expansion valve control	47
error code	
a1	96
a5	97
a6	99
ah	101
c4	103
c7	104
c9	103
cc	105
e1	109
e5	110
e6	111
e7	112
e8	113
ea	115
f3	117
f6	118
h0	120
h6	121
h8	123
h9	124
j3	124
j6	124
l3	126
l4	128
l5	130
p4	124
u0	132
u2	134
u4	106, 135
u7	138
ua	108
error code indication	87
expansion valve	226
expansion valve coil	210
F	
f3	117
f6	118
failure diagnosis	87
by led indication	86
by remote controller	85
with operation lamp	85
fan motor	193
fan motor (indoor)	176
fan motor (outdoor)	205, 210
fan motor system (dc motor) abnormality	99
fan rotor	193
fan speed control (indoor unit)	34
fan speed control (outdoor unit)	40
fan speed setting	8, 233
field setting	233
filter cleaning indicator	30
filters	
air filter	156
deodorizing filter for streamer	158
titanium apatite photocatalytic air-purifying filter ..	160
fin thermistor control	41
flash streamer air purifying	76
flash streamer air purifying operation	27
forced humidifying drying mode	32
forced operation mode	32
forced operation on / off switch	8
four way valve	224
four way valve abnormality	115
four way valve coil	210
four way valve for dehumidification check	153
four way valve operation	38
four way valve performance check	152
freeze-up protection	43, 97
front grille (indoor)	166
front panel (indoor)	156
front panel (outdoor)	205
front panel open / close abnormality	104
fu1	8, 10
fu2	10
fu3	10
functions	2
fuse	8, 10
H	
h0	120
h6	121
h8	123

h9	124
ha	8
hall ic	99
heat exchanger (indoor)	190
heating operation	74
high pressure control.....	97
high pressure control in cooling	118
horizontal blades	196
hot-start	36
humidifying airflow rate fine adjusting mode	32
humidifying hose length setting mode.....	32
humidity sensor abnormality	105
humidity sensor check.....	151
humidity sensor pcb	8, 105, 182

I

incompatible power supply	108
indoor heat exchanger freeze-up protection	43
indoor heat exchanger thermistor	103, 177
indoor unit demonstration.....	32
indoor unit pcb fault.....	96
indoor unit pcb output check	149
indoor unit quiet operation.....	23
information display	25, 82
input current control	41
input overcurrent detection.....	113
installation condition check	142
installation manual	
indoor units	54
outdoor units	64
instruction.....	70
insufficient gas	132
interlocking shaft	197

J

j3	124
j4	233
j6	124
ja	8, 233
jb	8, 233
jc.....	8, 233
jumper setting.....	233

L

l3	126
l4	128
l5	130
led a	8, 10
led2	8
led5	10
lights-out of microcomputer status lamp	140
limit switch.....	202
liquid compression protection 2.....	45
low voltage protection	134

M

main circuit electrolytic capacitor check.....	143
main circuit short check	151
mold proof stick.....	26
monitor brightness setting.....	24
multi monitor	24
multi-colored indicator lamp.....	24

N

night set mode	31
----------------------	----

O

ol activation.....	110
open/close mechanism	169
outdoor air thermistor.....	124
outdoor fan system check (dc motor)	142
outdoor heat exchanger thermistor.....	124, 221
outdoor unit pcb abnormality	109, 135
output overcurrent.....	130
over voltage protection	134
overcurrent.....	113
overload	110

P

p4.....	124
partition plate	222
pcb, removal of	214
peak-cut control	42, 97
pi control	37
piping diagrams	236
position sensor abnormality	121
power failure recovery function.....	8, 233
power initialization control.....	48
power supply terminal board.....	180
power supply waveform check.....	143
power transistor	234
power transistor check.....	146
power-airflow dual flaps	21
powerful operation	23, 76
preheating operation.....	38
pressure equalization control.....	51
printed circuit board (pcb)	
control pcb (indoor)	8, 180
control pcb (outdoor)	10
display pcb	8, 182
humidity sensor pcb	8, 105, 182
signal receiver / transmitter pcb	8
signal receiver pcb	182
streamer unit pcb	8, 202
propeller fan.....	193, 205

Q

quick warming function	38
------------------------------	----

R

r2t.....	8
----------	---

radiation fin.....128, 215
radiation fin thermistor.....124
reactor211, 222
receiver pcb.....182
reduction motor171
refrigerant system check144
reheating dehumidifying method14
remote controller71, 85
removal procedure155
room temperature thermistor.....103
rotating pulse input on outdoor unit pcb check.....150

S

s18, 176, 182
s2010, 210, 217
s218, 182
s328, 182
s4018
s4028
s4038
s418, 176, 182
s438, 175, 182
s4510, 217
s468, 182
s488, 182
s518, 182
s528, 175, 182
s568
s578
s588
s638
s7010, 210, 217
s8010, 210, 217
s9010, 211, 217
service check function85
service cover163
service monitor (led a).....203
set up81
shelter179
signal receiver / transmitter pcb8
signal transmission error106
signal transmission error on outdoor unit pcb138
silicon grease234
sound blanket.....218
special modes32
specifications.....4
streamer unit175, 199
streamer unit fault101
streamer unit pcb8, 202
sw18
swing motor.....176, 188

T

target discharge pipe temperature control50
temperature rise in radiation fin.....128
terminal cover.....228

thermistor
discharge pipe thermistor124, 221
indoor heat exchanger thermistor103, 177
outdoor air thermistor124
outdoor heat exchanger thermistor124, 221
radiation fin thermistor.....124
room temperature thermistor.....103
thermistor assembly.....211, 220
thermistor resistance check141
thermistor system abnormality.....103, 124
thermostat control33
timer operation.....79
24-hour on/off timer30
combination of on timer and off timer.....30
countdown off timer30
titanium apatite photocatalytic air-purifying filter ...160
trial operation232
trial operation mode32
troubleshooting87
by led indication86
by remote controller85
with operation lamp85

U

u0.....132
u2.....134
u4.....106, 135
u7.....138
ua.....108
upper panel.....163

V

v18
v2.....10
v3.....10
varistor8, 10
vertical blades.....196
v-shape temperature control.....16

W

wide-angle louvers.....21
wipe-clean flat panel29
wiring diagrams.....237



- Daikin Industries, Ltd.'s products are manufactured for export to numerous countries throughout the world. Daikin Industries, Ltd. does not have control over which products are exported to and used in a particular country. Prior to purchase, please therefore confirm with your local authorized importer, distributor and/or retailer whether this product conforms to the applicable standards, and is suitable for use, in the region where the product will be used. This statement does not purport to exclude, restrict or modify the application of any local legislation.
- Ask a qualified installer or contractor to install this product. Do not try to install the product yourself. Improper installation can result in water or refrigerant leakage, electrical shock, fire, or explosion.
- Use only those parts and accessories supplied or specified by Daikin. Ask a qualified installer or contractor to install those parts and accessories. Use of unauthorized parts and accessories or improper installation of parts and accessories can result in water or refrigerant leakage, electrical shock, fire, or explosion.
- Read the User's Manual carefully before using this product. The User's Manual provides important safety instructions and warnings. Be sure to follow these instructions and warnings.

If you have any inquiries, please contact your local importer, distributor, or retailer.



Intertek

©2010 Daikin Industries, Limited.

Daikin® AC Absolute Comfort®, and its design, VRV®. REFNET™, and Quaternity™ are registered trademarks of Daikin Industries, Limited. All rights reserved. LonWorks® and LON® are registered trademarks of Echelon Corporation. BACnet® is a Data Communication Protocol for Building Automation and Control Networks, developed under the auspices of the American Society of Heating, Refrigeration, and Air-Conditioning Engineers (ASHRAE).



JMI-0107



JQA-1452

About ISO 9001

ISO 9001 is a plant certification system defined by the International Organization for Standardization (ISO) relating to quality assurance. ISO 9001 certification covers quality assurance aspects related to the "design, development, manufacture, installation, and supplementary service" of products manufactured at the plant.



EC99J2044

About ISO 14001

ISO 14001 is the standard defined by the International Organization for Standardization (ISO) relating to environmental management systems. Our group has been acknowledged by an internationally accredited program of environmental protection procedures and activities to meet the requirements of ISO 14001.

Dealer

DAIKIN AC (AMERICAS), INC.

1645 Wallace Drive, Suite 110
Carrollton, TX75006
info@daikinac.com
www.daikinac.com

©All rights reserved

● Specifications, designs and other content appearing in this brochure are current as of October 2010 but subject to change without notice.