

DAIKIN



INSTALLATION MANUAL

R410A Split Series

INVERTER

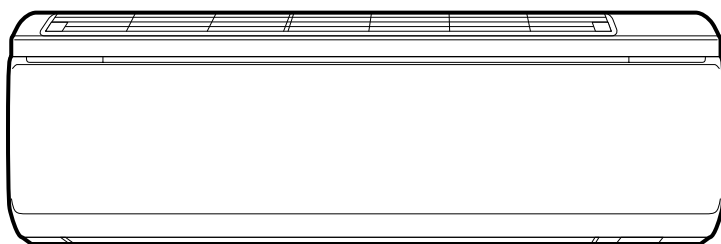

Models

FTXG09HVJU

FTXG12HVJU

FTXG15HVJU

Installation manual
Manuel d'installation

English

Français

Safety Precautions

- Read these Safety Precautions carefully to ensure correct installation.
- This manual classifies the precautions into DANGER, WARNING and CAUTION.
Be sure to follow all the precautions below: they are all important for ensuring safety.

 **DANGER**Indicates an imminently hazardous situation which, if not avoided, will result in death or serious injury.

 **WARNING** ..Failure to follow any of WARNING is likely to result in such grave consequences as death or serious injury.

 **CAUTION**....Failure to follow any of CAUTION may in some cases result in grave consequences.

- The following safety symbol is used throughout this manual:

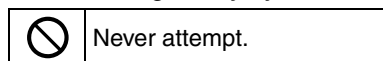

- After completing installation, test the unit to check for installation errors. Give the user adequate instructions concerning the use and cleaning of the unit according to the Operation Manual.

 DANGER
<ul style="list-style-type: none"> • Refrigerant gas is heavier than air and replaces oxygen. A massive leak could lead to oxygen depletion, especially in basements, and an asphyxiation hazard could occur leading to serious injury or death.
<ul style="list-style-type: none"> • If the refrigerant gas leaks during installation, ventilate the area immediately. Refrigerant gas may produce a toxic gas if it comes in contact with fire such as from a fan heater, stove or cooking device. Exposure to this gas could cause severe injury or death.
<ul style="list-style-type: none"> • After completing the installation work, check that the refrigerant gas does not leak. Refrigerant gas may produce a toxic gas if it comes in contact with fire such as from a fan heater, stove or cooking device. Exposure to this gas could cause severe injury or death.
<ul style="list-style-type: none"> • Do not ground units to water pipes, telephone wires or lightning rods because incomplete grounding could cause a severe shock hazard resulting in severe injury or death, and to gas pipes because a gas leak could result in an explosion which could lead to severe injury or death.
<ul style="list-style-type: none"> • Safely dispose of the packing materials. Packing materials, such as nails and other metal or wooden parts, may cause stabs or other injuries. Tear apart and throw away plastic packaging bags so that children will not play with them. Children playing with plastic bags face the danger of death by suffocation.
<ul style="list-style-type: none"> • Do not install unit in an area where flammable materials are present due to risk of explosion resulting in serious injury or death.
<ul style="list-style-type: none"> • Do not ground units to telephone wires or lightning rods because lightning strikes could cause a severe shock hazard resulting in severe injury or death, and to gas pipes because a gas leak could result in an explosion which could lead to severe injury or death.



 WARNING
<ul style="list-style-type: none"> • Installation shall be left to the authorized dealer or another trained professional. Improper installation may cause water leakage, electrical shock, fire, or equipment damage.
<ul style="list-style-type: none"> • Install the air conditioner according to the instructions given in this manual. Incomplete installation may cause water leakage, electrical shock, fire or equipment damage.
<ul style="list-style-type: none"> • Be sure to use the supplied or exact specified installation parts. Use of other parts may cause the unit to come to lose, water leakage, electrical shock, fire or equipment damage.
<ul style="list-style-type: none"> • Install the air conditioner on a solid base that is level and can support the weight of the unit. An inadequate base or incomplete installation may cause injury or equipment damage in the event the unit falls off the base or comes loose.
<ul style="list-style-type: none"> • Electrical work shall be carried out in accordance with the installation manual and the national, state and local electrical wiring codes. Insufficient capacity or incomplete electrical work may cause electrical shock, fire or equipment damage.
<ul style="list-style-type: none"> • Be sure to use a dedicated power circuit. Never use a power supply shared by another appliance. Follow all appropriate electrical codes.
<ul style="list-style-type: none"> • For wiring, use a wire or cable long enough to cover the entire distance with no splices if possible. Do not use an extension cord. Do not put other loads on the power supply. Use only a separate dedicated power circuit. (Failure to do so may cause abnormal heat, electric shock, fire or equipment damage.)
<ul style="list-style-type: none"> • Use the specified types of wires for electrical connections between the indoor and outdoor units. Follow all state and local electrical codes. Firmly clamp the interconnecting wires so their terminals receive no external stresses. Incomplete connections or clamping may cause terminal overheating, fire or equipment damage.
<ul style="list-style-type: none"> • After connecting all wiring be sure to shape the cables so that they do not put undue stress on the electrical covers, panels or terminals. Install covers over the wires. Incomplete cover installation may cause terminal overheating, electrical shock, fire or equipment damage.
<ul style="list-style-type: none"> • When installing or relocating the system, be sure to keep the refrigerant circuit free from all substances other than the specified refrigerant (R410A), such as air. (Any presence of air or other foreign substance in the refrigerant circuit causes an abnormal pressure rise which may result in rupture, resulting in injury.)
<ul style="list-style-type: none"> • During pump-down, stop the compressor before removing the refrigerant piping. If the compressor is still running and the stop valve is open during pump-down, air will be sucked in when the refrigerant piping is removed, causing abnormally high pressure which could lead to equipment damage or and personal injury.

Safety Precautions

⚠ WARNING

- During installation, attach the refrigerant piping securely before running the compressor. If the refrigerant pipes are not attached and the stop valve is open during pump-down, air will be sucked in when the compressor is run, causing abnormally high pressure which could lead to equipment damage and personal injury.
- Be sure to install a ground fault circuit interrupter. Failure to install a ground fault circuit interrupter may result in electrical shocks, or fire personal injury.

⚠ CAUTION

- Do not install the air conditioner where gas leakage would be exposed to open flames. If the gas leaks and builds up around the unit, it may catch fire. 
- Establish drain piping according to the instructions of this manual. Inadequate piping may cause water damage.
- Tighten the flare nut according to the specified torque. A torque wrench should be used. If the flare nut is tightened too much, the flare nut may crack over time and cause refrigerant leakage.
- Do not touch the heat exchanger fins. Improper handling may result in injury. 
- Be very careful about product transportation. Some products use PP bands for packaging. Do not use any PP bands for a means of transportation. It is dangerous.
- Electrical work must be performed in accordance with the NEC/CEC by authorized personnel only.

Accessories

Ⓐ Mounting plate	1	Ⓔ Wireless remote controller	1	Ⓙ Installation manual	1
Ⓑ Deodorizing filter for streamer	1	Ⓕ Remote controller holder	1	Ⓚ Mounting plate fixing screws 3/16" × 1"L (M4 × 25mm)	9
Ⓒ Titanium apatite photocatalytic air-purifying filter	1	Ⓖ Dry batteries AAA. LR03 (alkaline)	2	Ⓛ Fixing screws for remote controller holder 1/8" × 13/16"L (M3 × 20mm)	2
Ⓓ Indoor unit fixing screws 3/16" × 1/2"L (M4 × 12mm)	3	Ⓗ Operation manual	1		

Choosing an Installation Site

- Before choosing the installation site, obtain user approval.

1. Indoor unit

- The indoor unit should be sited in a place where:
 - 1) the restrictions on installation specified in the indoor unit installation drawings are met,
 - 2) both air intake and exhaust have clear paths met,
 - 3) the unit is not in the path of direct sunlight,
 - 4) the unit is away from the source of heat or steam,
 - 5) there is no source of machine oil vapour (this may shorten indoor unit life),
 - 6) cool (warm) air is circulated throughout the room,
 - 7) the unit is away from electronic ignition type fluorescent lamps (inverter or rapid start type) as they may shorten the remote control range,
 - 8) the unit is at least 3.5ft (1m) away from any television or radio set (unit may cause interference with the picture or sound),
 - 9) no laundry equipment is located in the space.

2. Wireless remote controller

- 1) Turn on all the fluorescent lamps in the room, if any, and find the site where remote control signals are properly received by the indoor unit (within 23ft/7m).

Indoor Unit Installation Drawings

1. Removing and installing indoor unit

• Installation method

- Using the \triangle marks (3 locations) on top of the indoor unit, attach the (A) mounting plate hooks onto the indoor unit.
- Attach the tabs on the bottom frame onto the (A) mounting plate. If the tabs are not hooked onto the plate, remove the front grille to hook them. (Check to see if the tabs are hooked securely.)

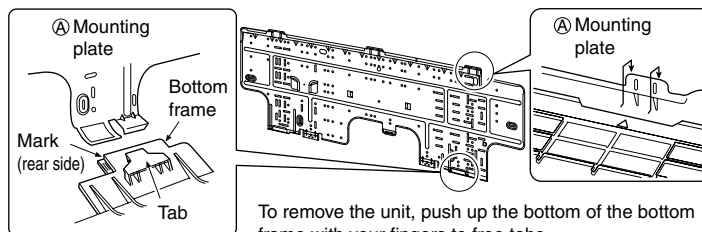

To remove the unit, push up the bottom of the bottom frame with your fingers to free tabs. (Mark parts (2 locations) on the bottom of the front grille.)

• Removal method

Push up the mark part on the bottom of the front grille, discharge the tabs, and then remove the unit while lifting it up.

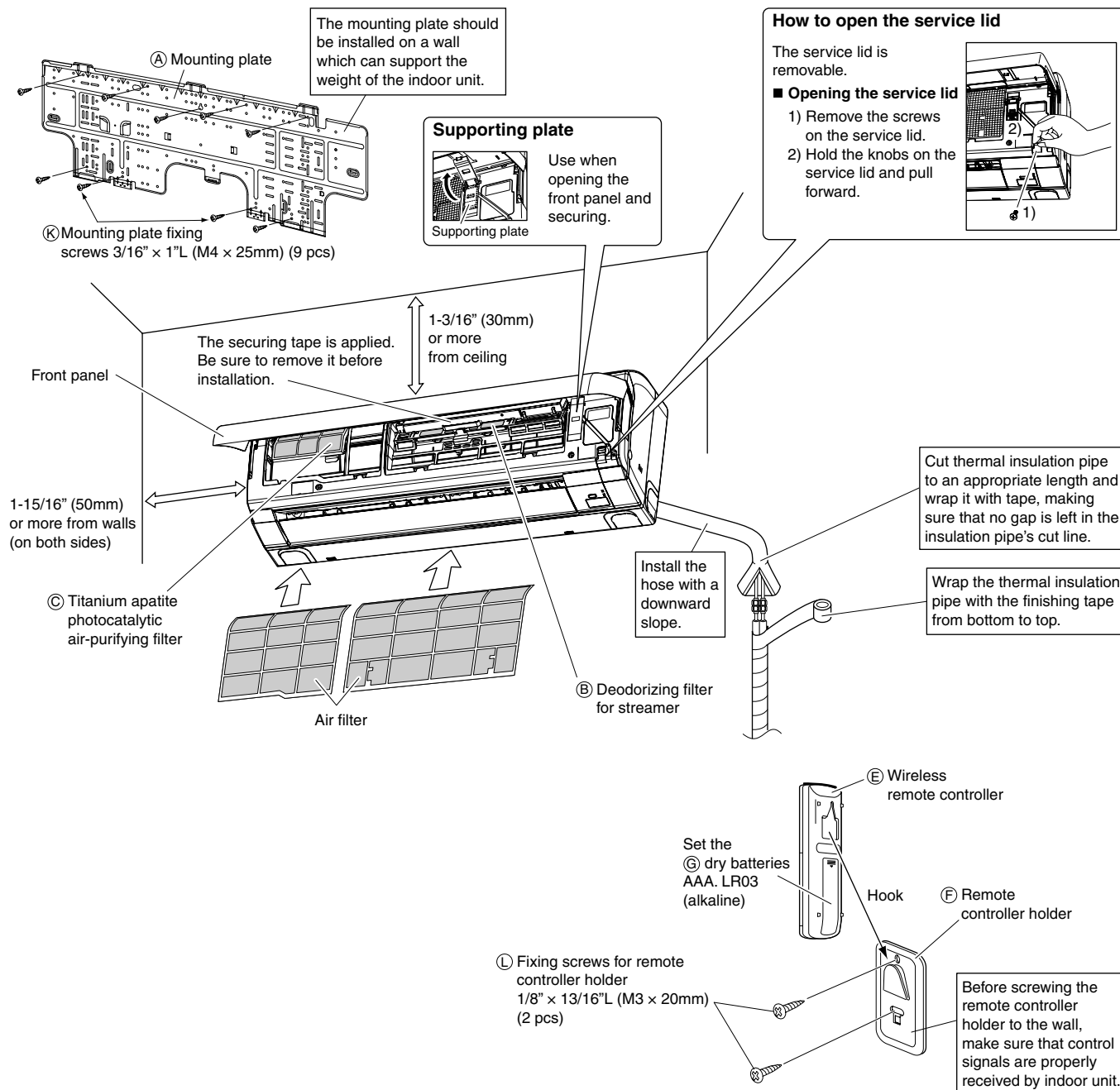

Installation Tips

1. Removing and installing the front panel

• Removal method

- 1) Open the front panel.
- 2) Spread out the shaft hole on the left side and remove the front panel shaft.
Spread out the shaft hole on the right side as well and remove the front panel shaft.

• Installation method

Insert the right and left front panel shafts into the shaft holes one at a time and slowly close the panel.
(Press on both sides of the front panel.)

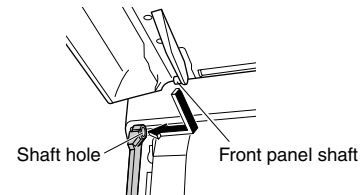
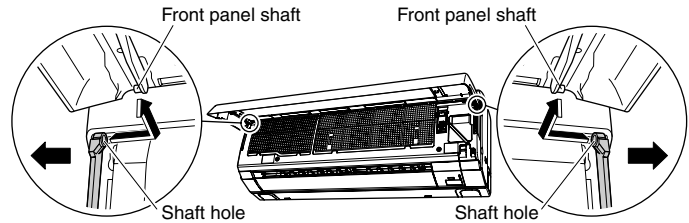

2. Removing and installing the upper panel

• Removal method

- 1) Remove the front panel and air filter.
- 2) Hold and pull forward 2 tabs on both sides to discharge them, discharge the center tab, and then lift up the upper panel.

• Installation method

- 1) Push in the upper panel along the guide on the top of the front grille and insert the 3 tabs into the slots on the front grille.
- 2) Push the upper panel down until it clicks.
- 3) Attach the air filter and front panel.

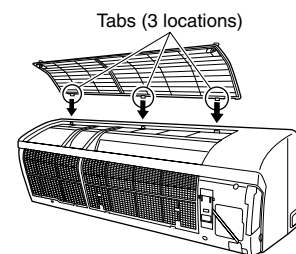
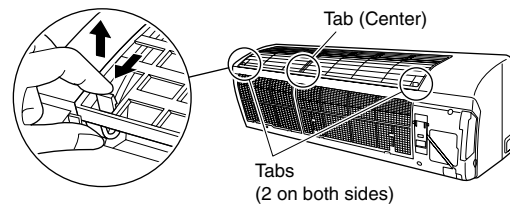

3. Removing and installing the front grille

• Removal method

- 1) Remove the front panel, air filter and upper panel.
- 2) Fully open the top and bottom louvers (horizontal blades).
(See Fig. 1)
- 3) Remove the 3 screws in the front grille.
- 4) Lift the hooks (3 locations) on the front grille with a flathead screwdriver to discharge the tab.
(Look for the ○○○ mark.) (See Fig. 2)
- 5) Pull forward the front grille to remove.

• Installation method

- 1) Open the top louver fully and close the bottom louver fully.
- 2) Store the gear case arm in the front grille. (See Fig. 3)
- 3) Attach the front grille to the lower part of the unit.
(Use caution not to pinch the louver.)
- 4) Make sure to firmly latch the top hooks (3 locations).
- 5) Tighten with the 3 front grille screws.
- 6) Attach the upper panel, air filter and front panel.

Fig. 1

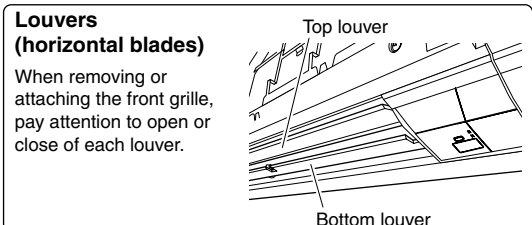

Fig. 2

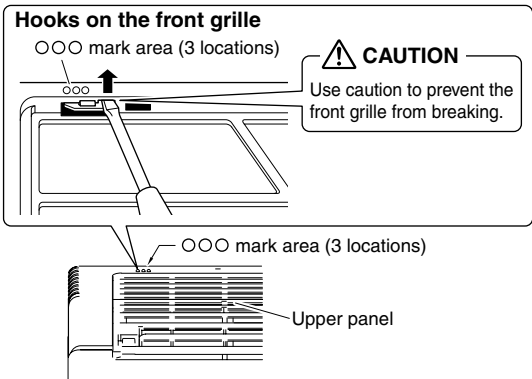
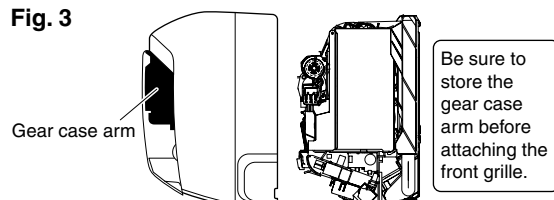
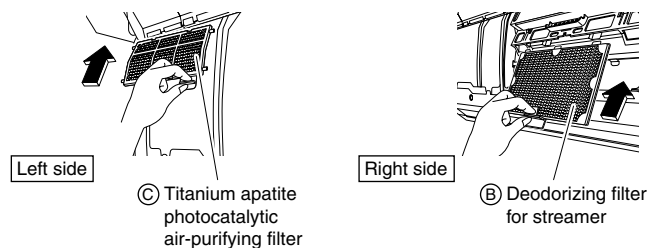

Fig. 3



4. Installing the titanium apatite photocatalytic air-purifying filter and deodorizing filter for streamer

- 1) Open the front panel to pull out the air filter.
- 2) Attach the ③ titanium apatite photocatalytic air-purifying filter.
- 3) Attach the ④ deodorizing filter for streamer.
- 4) Replace the air filter to its original position and close the front panel.



5. How to replace the drain plug and drain hose

• Replacing onto the left side

- 1) Remove the insulation fixing screws on the right to remove the drain hose.
- 2) Reattach the insulation fixing screw on the right as it was. *(Forgetting to attach this may cause water leakages.)
- 3) Remove the drain plug on the left side and attach it to the right side.
- 4) Insert the drain hose and tighten with included ⑤ indoor unit fixing screw.

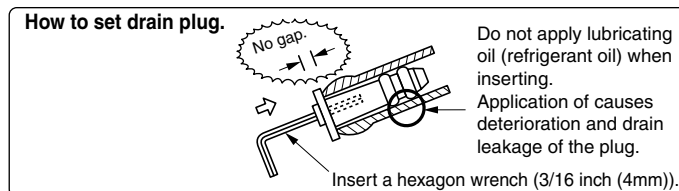
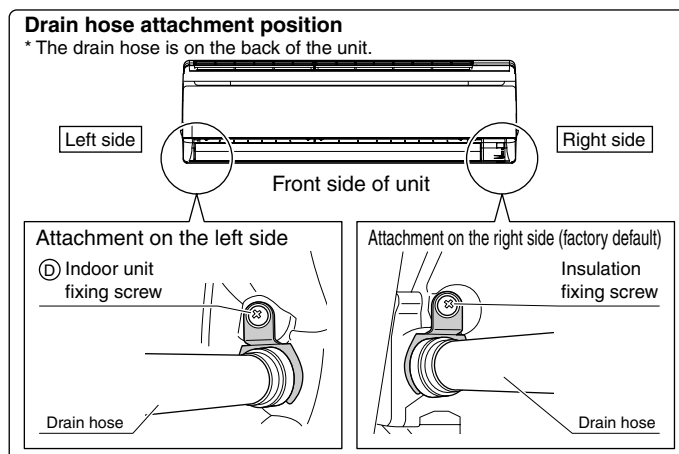

6. How to set the different addresses

- When 2 indoor units are installed in 1 room, the 2 wireless remote controllers can be set for different addresses.

- 1) Remove the front grille. (3 screws)
- 2) Cut the address jumper "JA". (See Fig. 1)

Fig. 1

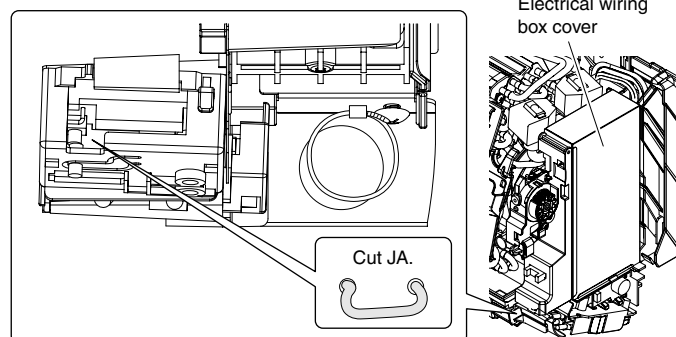

- 3) Remove the remote controller lid and cut the address jumper "J4". (See Fig. 2)

Fig. 2

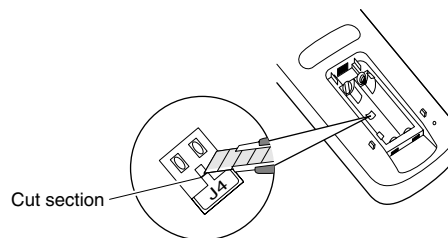

Indoor Unit Installation

1. Installing the mounting plate

- The (A) mounting plate should be installed on a wall which can support the weight of the indoor unit.
 - Temporarily secure the (A) mounting plate to the wall, make sure that the panel is completely level, and mark the boring points on the wall.
 - Secure the (A) mounting plate to the wall with screws.

Recommended mounting plate retention spots and Dimensions

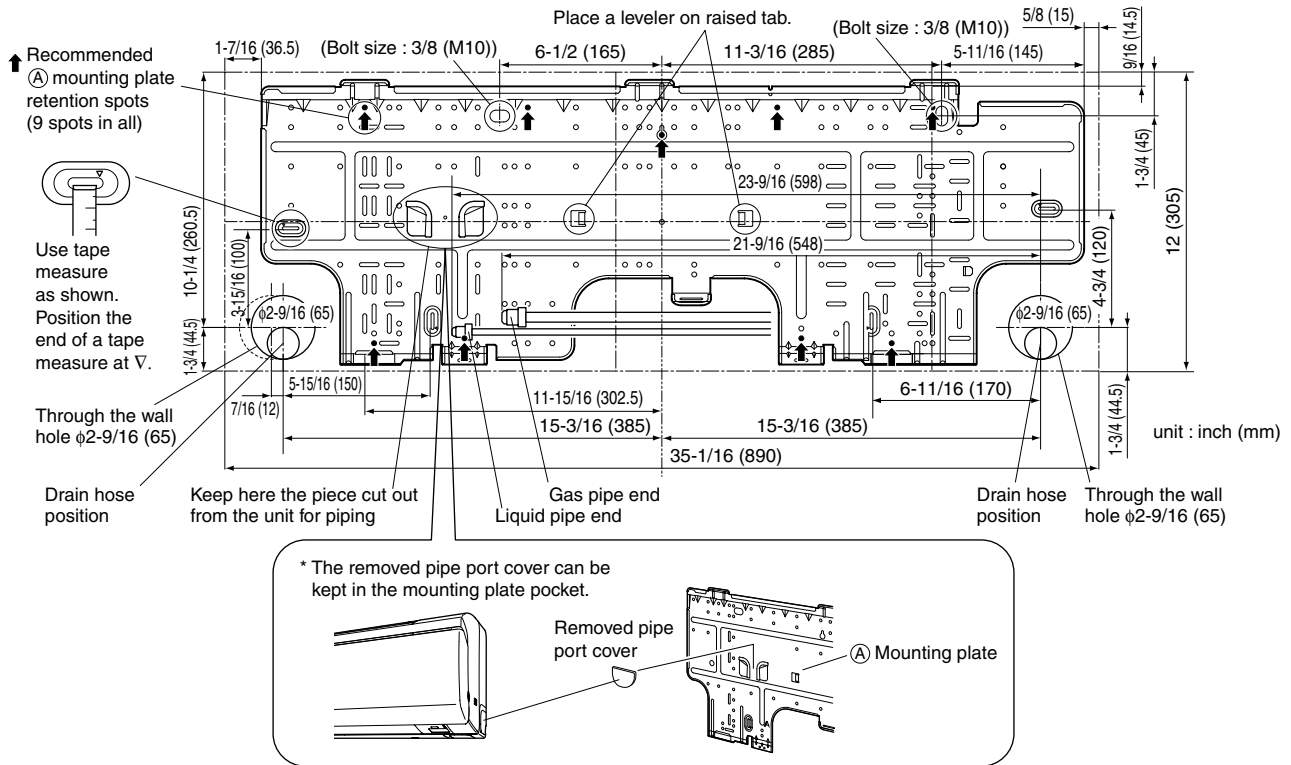

2. Boring a wall hole and installing wall embedded pipe

- For walls containing metal frame or metal board, be sure to use a wall embedded pipe and wall cover in the feed-through hole to prevent possible heat, electrical shock, or fire.
- Be sure to caulk the gaps around the pipes with caulking material to prevent water leakage.
 - Bore a feed-through hole of $\phi 2-9/16$ inch (65mm) in the wall so it has a down slope toward the outside.
 - Insert a wall pipe into the hole.
 - Insert a wall cover into wall pipe.
 - After completing refrigerant piping, wiring, and drain piping, caulk pipe hole gap with putty.

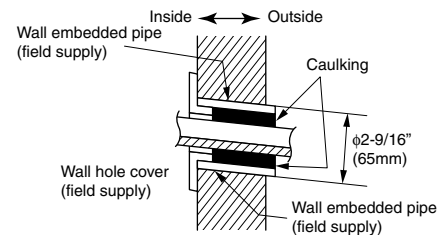

3. Installing inter-unit wiring

- Open the front panel and remove the service lid.
- Pull out the inter-unit wire from the back of the indoor unit to the front. It is easier to pull out if bending up the wire edge in advance.
- To connect the inter-unit wire after hooking the unit onto the (A) mounting plate, connect the inter-unit wire as shown in the figure at right.

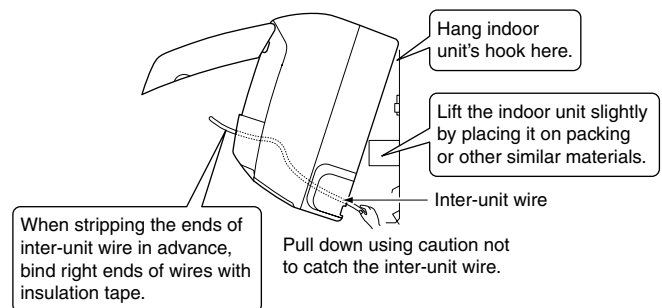

4. Laying piping, hoses, and wiring

- Lay the refrigerant pipes and drain hose according to the orientation of the piping coming out of the unit, as shown below.
- Make sure the drain hose is sloped downward.
- Wrap the refrigerant pipes and drain hose together using insulation tape.

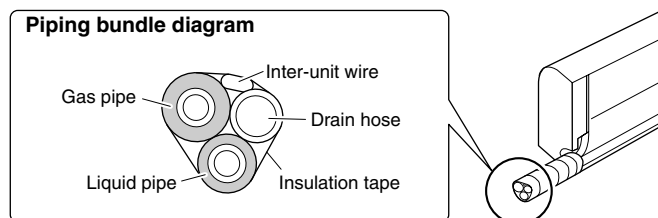

4-1. Right-side, right-back, or right-bottom piping

• Right-side piping

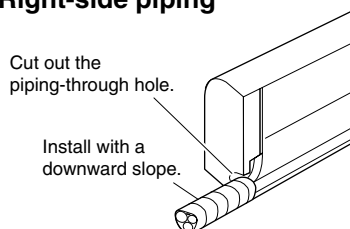

• Right-back piping

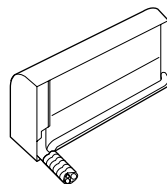

• Right-bottom piping

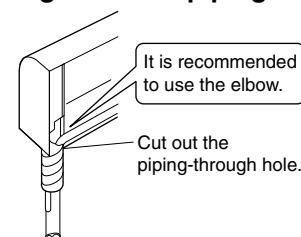

- 1) Wrap the refrigerant pipes and inter-unit wire using insulation tape as shown in the piping bundle diagram.
- 2) Put all the pipes through the through-hole in the wall and hook the indoor unit onto the (A) mounting plate.
- 3) Connect the pipes.

4-2. Left-side, left-back, or left-bottom piping

• Left-side piping

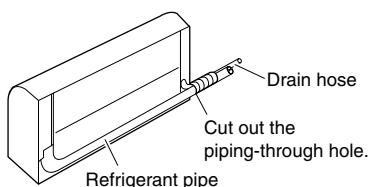

• Left-back piping

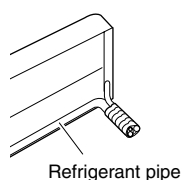

• Left-bottom piping

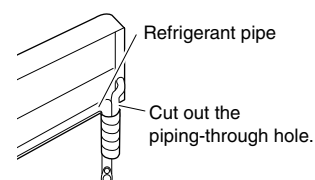

- 1) Replace the drain plug and drain hose. **(How to replace the drain plug and drain hose.)**
- 2) Pull in the refrigerant pipes lay it so that it matches the liquid and gas piping marked on the (A) mounting plate.
- 3) Hook the indoor unit onto the (A) mounting plate.
- 4) Connect the pipes. If it is difficult to do, remove the front panel first.
- 5) Wrap the insulation on the refrigerant pipes with insulation tape. If you are not replacing the drain hose, store it in the location shown below.

When securing the indoor unit with screws

- 1) Remove the front grille.
- 2) Secure the indoor unit with the (D) indoor unit fixing screws.
- 3) Install the front grille.

(D) 3/16" x 1/2"L (M4 x 12mm)

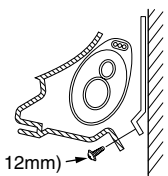

4-3. Left-back piping

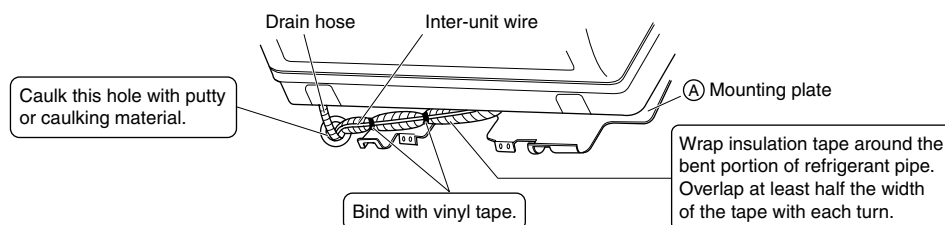

Indoor Unit Installation

4-4. Wall embedded piping

Follow the instructions given under left-side, left-back, or left-bottom piping.

- 1) Insert the drain hose to this depth so it won't be pulled out of the drain pipe.

Insert the drain hose to this depth so it won't be pulled out of drain pipe.

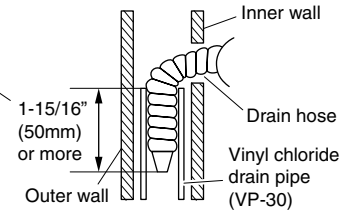

⚠ WARNING

Do not bundle the power code with a binding band, a twist tie or other method. This may cause heat, electric shock or fire.

5. Wiring

- 1) As shown in the illustration, insert the wires including the ground wire into the conduit and secure them with lock nut onto the conduit mounting plate.
- 2) Strip wire ends (3/4 inch (20mm)).
- 3) Match wire colours with terminal numbers on indoor and outdoor unit's terminal blocks and firmly screw wires to the corresponding terminals.
- 4) Connect the ground wires to the corresponding terminals.
- 5) Pull the wires to make sure that they are securely connected, and retain the wires with the binding band as shown in the illustration below.
- 6) In case of connecting to an adapter system. Run the remote controller cable and attach the S21. (Refer to **6. Connecting to the HA system.**)
- 7) Shape the wires so that the service lid fits securely, then close service lid.

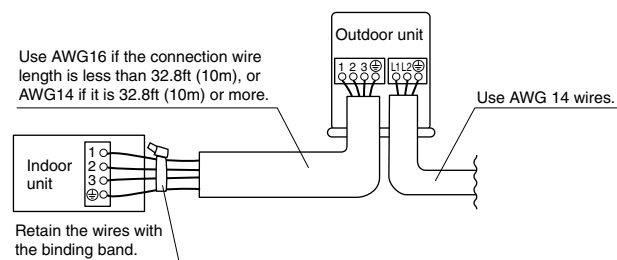
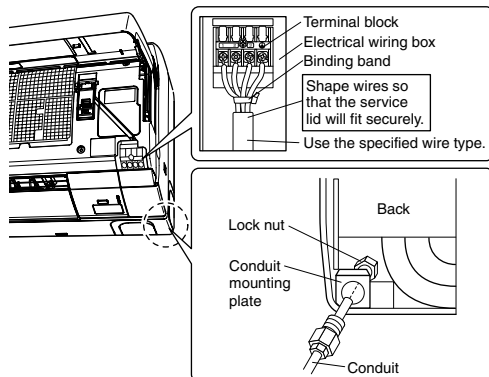

⚠ WARNING

- Do not use tapped wires, stranded wires, extension cords, or starburst connections, as they may cause overheating, electrical shock, or fire.
- Do not use locally purchased electrical parts inside the product. (Do not branch the power for the drain pump, etc., from the terminal block.) Doing so may cause electric shock or fire.
- When carrying out wiring connection, take care not to pull at the conduit.
- Do not connect the power wire to the indoor unit. Doing so may cause electric shock or fire.

6. Connecting to the HA system

- 1) Remove the front grille. (3 screws)
- 2) Remove the decelerator assembly parts. (1 screw)
 - 2-1) Remove the decelerator assembly part screws. (See Fig. 1)
 - 2-2) Remove the decelerator assembly part connector. Remove by pressing on the tabs on the bottom of the connector. (See the tab position Fig. 1)
- 3) Remove the electrical wiring box. (1 screw, 2 tabs)
 - 3-1) Remove the electrical wiring box fixing screw.
 - 3-2) Pull the electrical wiring box toward you and discharge the tab 2.

Fig. 1

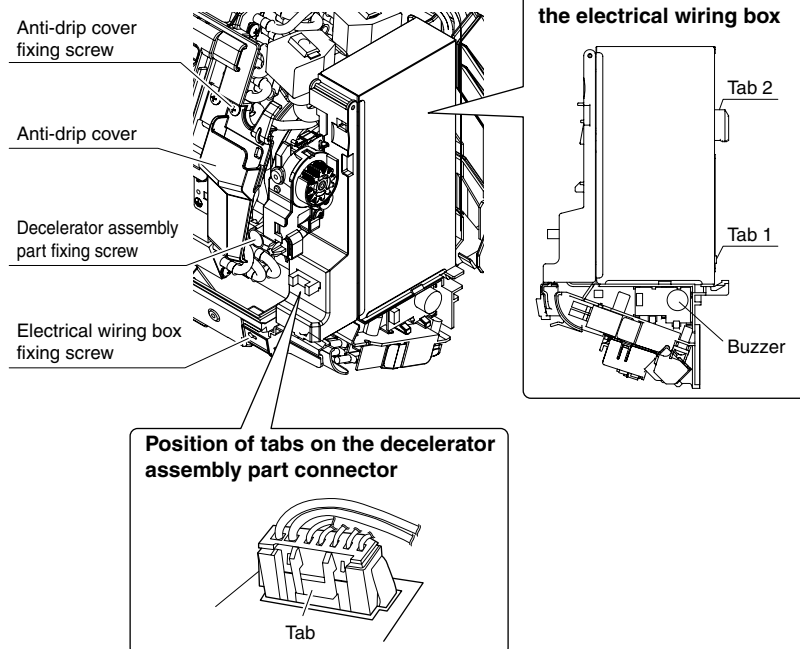

- 4) Remove the electrical wiring box cover. (3 tabs) (Refer to Fig. 2)
 - 4-1) Discharge the tab 3.
 - 4-2) Pull up the electrical wiring box cover slowly, discharge the tab 4, slide up, and discharge the tab 5.
- 5) Insert the connection cord into the HA connector "S21".

Fig. 2

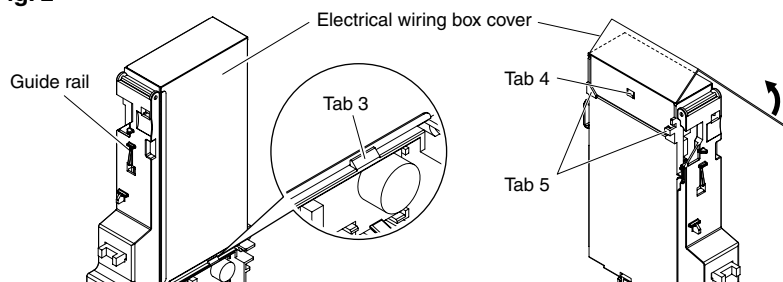

- 6) Lay the connection cord as shown in "Fig. 3".
- 7) Replace the electrical wiring box cover and electrical wiring box as they were.
- 8) Attach the decelerator assembly part along with the guide rail. (Refer to Fig. 2)
- 9) Install the front grille.

Fig. 3

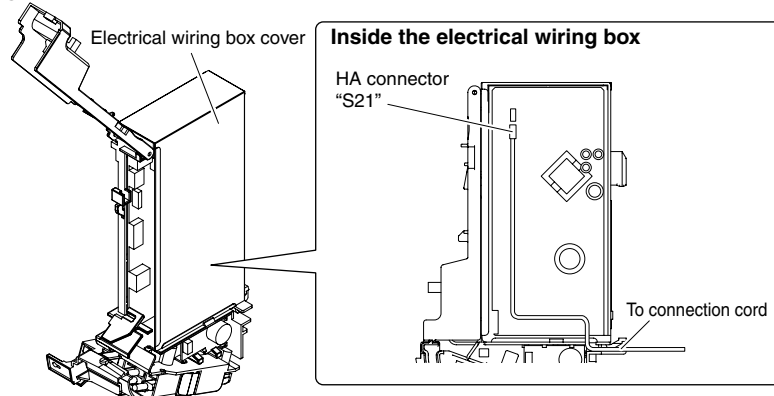

Indoor Unit Installation

7. Drain piping

1) Connect the drain hose, as described right.

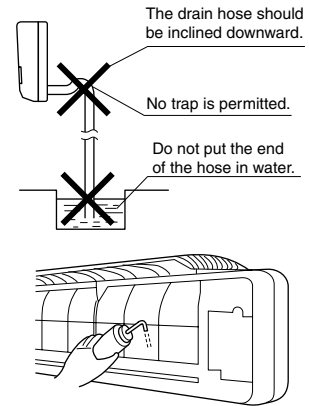

2) Remove the air filters and pour some water into the drain pan to check the water flows smoothly.

3) When drain hose requires extension, obtain an extension hose commercially available.

Be sure to thermally insulate the indoor section of the extension hose.

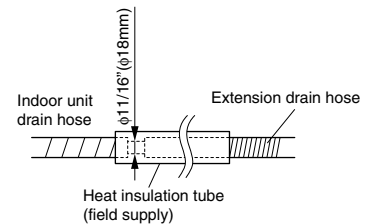

4) When connecting a rigid polyvinyl chloride pipe (nominal diameter 1/2 inch (13mm)) directly to the drain hose attached to the indoor unit as with embedded piping work, use any commercially available drain socket (nominal diameter 1/2 inch (13mm)) as a joint.

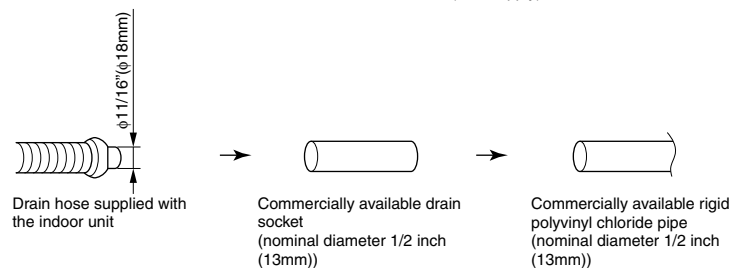

8. Improving installation strength

- We recommend screwing the indoor unit onto a ① mounting plate in order to improve the installation strength.

- Remove the front grille.
- Screw in the indoor unit with ② fixing screws.
- Attach the front grille.

Screw position
Front diagram

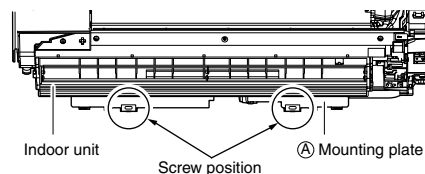

Enlarged diagram

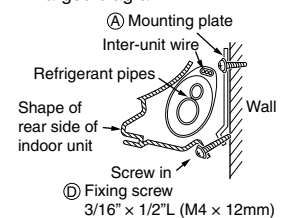

Refrigerant Piping Work

1. Flaring the pipe end

- 1) Cut the pipe end with a pipe cutter.
- 2) Remove burrs with the cut surface facing downward so that the chips do not enter the pipe.
- 3) Put the flare nut on the pipe.
- 4) Flare the pipe.
- 5) Check that the flaring is properly made.

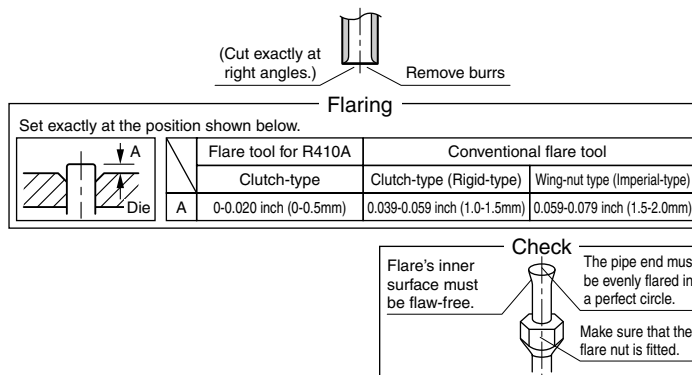

⚠ WARNING

- Do not use mineral oil on flared part.
- Prevent mineral oil from getting into the system as this would reduce the lifetime of the units.
- Never use piping which has been used for previous installations. Only use parts which are delivered with the unit.
- Do never install a drier to this R410A unit in order to guarantee its lifetime.
- The drying material may dissolve and damage the system.
- Incomplete flaring may cause refrigerant gas leakage.

2. Refrigerant piping

⚠ CAUTION

- Use the flare nut fixed to the main unit to prevent it from cracking and deteriorating from age.
- To prevent gas leakage, apply refrigeration oil only to the inner surface of the flare. (Use refrigeration oil for R410A.)
- Use torque wrenches when tightening the flare nuts to prevent damage to the flare nuts and gas leakage.

Align the centers of both flares and tighten the flare nuts 3 or 4 turns by hand. Then tighten them fully with the torque wrenches.

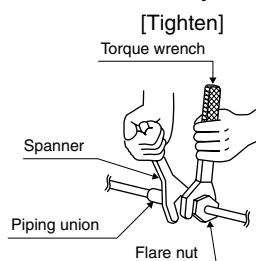
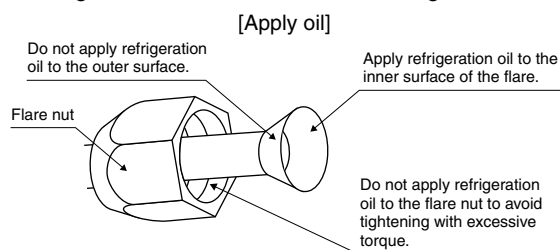

Flare nut tightening torque	
Gas side	Liquid side
3/8 inch (9.5mm)	1/4 inch (6.4mm)
24.1-29.4 ft-lbf (32.7-39.9 N-m)	10.4-12.7 ft-lbf (14.2-17.2 N-m)

2-1. Caution on piping handling

- 1) Protect the open end of the pipe against dust and moisture.
- 2) All pipe bends should be as gentle as possible. Use a pipe bender for bending.

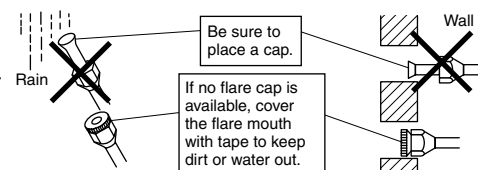

2-2. Selection of copper and heat insulation materials

- When using commercial copper pipes and fittings, observe the following:

- 1) Insulation material: Polyethylene foam
Heat transfer rate: 0.041 to 0.052W/mK
(0.024 to 0.030 Btu/ft²°F (0.035 to 0.045 kcal/mh°C))

Be sure to use insulation that is designed for use with HVAC Systems.

- 2) Be sure to insulate both the gas and liquid piping and to provide insulation dimensions as below.

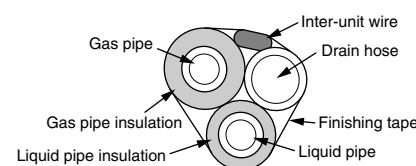

Gas side	Liquid side	Gas pipe thermal insulation	Liquid pipe thermal insulation
O.D. 3/8 inch (9.5mm)	O.D. 1/4 inch (6.4mm)	I.D. 15/32-19/32 inch (12-15mm)	I.D. 5/16-13/32 inch (8-10mm)
Minimum bend radius		Thickness 13/32 inch (10mm) Min.	
1-3/16 inch (30mm) or more			
Thickness 0.031 inch (0.8mm) (C1220T-O)			

- 3) Use separate thermal insulation pipes for gas and liquid refrigerant pipes.

Trial Operation and Testing

1. Trial operation and testing

1-1. Measure the supply voltage and make sure that it falls in the specified range

1-2. Trial operation should be carried out in either cooling or heating mode

- In cooling mode, select the lowest programmable temperature; in heating mode, select the highest programmable temperature.
 - 1) Trial operation may be disabled in either mode depending on the room temperature.
Use the remote controller for trial operation as described below.
 - 2) After trial operation is complete, set the temperature to a normal level (78°F to 82°F (26°C to 28°C) in cooling mode, 68°F to 75°F (20°C to 24°C) in heating mode).
 - 3) For protection, the system disables restart operation for 3 minutes after it is turned off.

1-3. Carry out the test operation in accordance with the operation manual to ensure that all functions and parts are working properly

- Even when the air conditioner is not operating, it consumes some electric power. If the customer is not going to use the unit soon after it is installed, turn off the breaker to avoid wasting electricity.

Trial operation from remote controller

- 1) Hold the "CLOCK button" for 5 seconds.
(The matrix display will appear on the remote controller.)
- 2) Display "SETTING" on the matrix display of the remote controller and press the "CLOCK button".

SETTING
1, TEST
- 3) "7" will be displayed and the unit will enter trial operation.
- 4) Press the button for trial operation.
 - Trial operation will stop automatically after around 30 minutes.
To quit a trial operation, press "ON/OFF" button.

2. Test items

Test items	Symptom (diagnostic display on RC)	Check
Indoor and outdoor units are installed properly on solid bases.	Fall, vibration, noise	
Did you install the deodorizing filter for the streamer and the titanium apatite photocatalytic air-purifying filter?	Noise, water leakage	
Have you performed a gas leak test?	Incomplete cooling/heating function	
No refrigerant gas leaks.	Incomplete cooling/heating function	
Refrigerant gas and liquid pipes and indoor drain hose extension are thermally insulated.	Water leakage	
Draining line is properly installed.	Water leakage	
Does the drain hose produce abnormal noise (perking sound) when using the ventilation fan or others?	Use of separately sold air cut drain plug	
System is properly grounded.	Electrical leakage	
The specified wires are used for inter-unit wiring.	Inoperative or burn damage	
Indoor or outdoor unit's air inlet or outlet has clear path of air.	Incomplete cooling/heating function	
Stop valves are opened.	Incomplete cooling/heating function	
Indoor unit properly receives remote controller commands.	Inoperative	
Did you check the address setting?	Inoperative	

DAIKIN AC (AMERICAS), INC.

1645 Wallace Drive, Suite 110
Carrollton, TX75006

info@daikinac.com
www.daikinac.com

DAIKIN INDUSTRIES, LTD.

Head office:

Umeda Center Bldg., 2-4-12, Nakazaki-Nishi,
Kita-ku, Osaka, 530-8323 Japan

Tokyo office:

JR Shinagawa East Bldg., 2-18-1, Konan,
Minato-ku, Tokyo, 108-0075 Japan



Two-dimensional bar code is a code for manufacturing.

3P227261-1B

M07B241B (1211) HT