

Service Manual

Inverter Pair Wall Mounted Type FTX-N Series

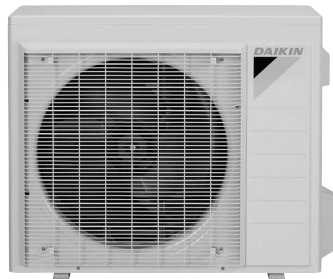
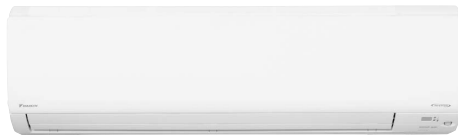

[Applied Models]

- Inverter Pair : Cooling Only
- Inverter Pair : Heat Pump

Inverter Pair Wall Mounted Type FTX-N Series

●Cooling Only

Indoor Unit

FTX30NVJU

FTX36NVJU

Outdoor Unit

RK30NMVJU

RK36NMVJU

●Heat Pump

Indoor Unit

FTX30NVJU

FTX36NVJU

Outdoor Unit

RX30NMVJU

RX36NMVJU

1. Safety Cautions.....	v
1.1 Warnings and Cautions Regarding Safety of Workers.....	v
1.2 Warnings and Cautions Regarding Safety of Users.....	vii
2. Icons Used	x
Part 1 List of Functions	1
1. Functions.....	2
Part 2 Specifications	3
1. Specifications	4
1.1 Cooling Only	4
1.2 Heat Pump	5
Part 3 Printed Circuit Board Connector Wiring Diagram	6
1. Indoor Unit.....	7
1.1 FTX30/36NVJU	7
2. Outdoor Unit.....	9
2.1 RK(X)30/36NMVJU	9
Part 4 Functions and Control.....	12
1. Main Functions.....	13
1.1 Temperature Control	13
1.2 Frequency Principle.....	13
1.3 Airflow Direction Control.....	15
1.4 Fan Speed Control for Indoor Unit	16
1.5 Program Dry Operation	17
1.6 Automatic Operation.....	18
1.7 Thermostat Control.....	19
1.8 NIGHT SET Mode	20
1.9 ECONO Operation	20
1.10 INTELLIGENT EYE Operation	21
1.11 POWERFUL Operation	22
1.12 Clock Setting	23
1.13 WEEKLY TIMER Operation	24
1.14 Other Functions.....	30
2. Thermistor Functions	31
3. Control Specification	33
3.1 Mode Hierarchy	33
3.2 Frequency Control.....	34
3.3 Controls at Mode Changing/Start-up.....	36
3.4 Discharge Pipe Temperature Control.....	38
3.5 Input Current Control.....	39
3.6 Freeze-up Protection Control	40
3.7 Heating Peak-cut Control	40
3.8 Outdoor Fan Control.....	41

3.9	Liquid Compression Protection Function.....	41
3.10	Defrost Control	42
3.11	Electronic Expansion Valve Control	43
3.12	Malfunctions	46

Part 5 Remote Controller..... 47

1.	Remote Controller	48
----	-------------------------	----

Part 6 Service Diagnosis..... 50

1.	General Problem Symptoms and Check Items	52
2.	Troubleshooting with LED	53
2.1	Indoor Unit.....	53
2.2	Outdoor Unit.....	53
3.	Service Diagnosis	54
4.	Troubleshooting	57
4.1	Error Codes and Description	57
4.2	Indoor Unit PCB Abnormality	58
4.3	Freeze-up Protection Control/Heating Peak-cut Control	60
4.4	Indoor Fan Motor (DC Motor) or Related Abnormality	61
4.5	Thermistor or Related Abnormality (Indoor Unit).....	63
4.6	Low-voltage Detection or Over-voltage Detection.....	64
4.7	Signal Transmission Error (between Indoor Unit and Outdoor Unit)	66
4.8	Signal Transmission Error on Outdoor Unit PCB	68
4.9	Mismatching of Indoor Unit and Outdoor Unit	69
4.10	Outdoor Unit PCB Abnormality.....	70
4.11	OL Activation (Compressor Overload)	71
4.12	Compressor Lock	73
4.13	DC Fan Lock (Outdoor Fan).....	74
4.14	Input Overcurrent Detection	75
4.15	Four Way Valve Abnormality.....	76
4.16	Discharge Pipe Temperature Control.....	78
4.17	High Pressure Control in Cooling	79
4.18	System Shutdown due to Compressor Internal Temperature Abnormality	80
4.19	Compressor System Sensor Abnormality	81
4.20	Position Sensor Abnormality	82
4.21	CT or Related Abnormality	84
4.22	Thermistor or Related Abnormality (Outdoor Unit).....	86
4.23	Electrical Box Temperature Rise.....	88
4.24	Radiation Fin Temperature Rise	89
4.25	Output Overcurrent Detection	90
5.	Check	92
5.1	Thermistor Resistance Check	92
5.2	Indoor Fan Motor Connector Output Check	93
5.3	Power Supply Waveforms Check.....	93
5.4	Electronic Expansion Valve Check.....	94

5.5	Four Way Valve Performance Check	95
5.6	Inverter Unit Refrigerant System Check	95
5.7	Inverter Analyzer Check	96
5.8	Rotation Pulse Check on the Outdoor Unit PCB	98
5.9	Installation Condition Check	99
5.10	Discharge Pressure Check	99
5.11	Outdoor Fan System Check	100
5.12	Main Circuit Short Check	100
5.13	Capacitor Voltage Check	101
5.14	Power Module Check	101

Part 7 Trial Operation and Field Settings..... 103

1.	Pump Down Operation	104
2.	Forced Cooling Operation	105
3.	Trial Operation	106
4.	Field Settings	107
4.1	Model Type Setting	107
4.2	Temperature Display Switch	107
4.3	When 2 Units are Installed in 1 Room	108
4.4	Facility Setting Switch (cooling at low outdoor temperature)	109
5.	Silicone Grease on Power Transistor/Diode Bridge	111





Part 8 Appendix..... 112

1.	Piping Diagrams	113
1.1	Indoor unit	113
1.2	Outdoor Unit	114
2.	Wiring Diagrams	115
2.1	Indoor Unit	115
2.2	Outdoor Unit	116
3.	Operation Limit	117



1. Safety Cautions

Be sure to read the following safety cautions before conducting repair work. After the repair work is complete, be sure to conduct a test operation to ensure that the equipment operates normally, and explain the cautions for operating the product to the customer.







Caution Items





The caution items are classified into  **Warning** and  **Caution**. The  **Warning** items are especially important since death or serious injury can result if they are not followed closely. The  **Caution** items can also lead to serious accidents under some conditions if they are not followed. Therefore, be sure to observe all the safety caution items described below.







Pictograms



-  This symbol indicates an item for which caution must be exercised. The pictogram shows the item to which attention must be paid.
-  This symbol indicates a prohibited action. The prohibited item or action is shown in the illustration or near the symbol.
-  This symbol indicates an action that must be taken, or an instruction. The instruction is shown in the illustration or near the symbol.

1.1 Warnings and Cautions Regarding Safety of Workers







 Warning	
Do not store equipment in a room with fire sources (e.g., naked flames, gas appliances, electric heaters).	
Be sure to disconnect the power cable from the socket before disassembling equipment for repair. Working on equipment that is connected to the power supply may cause an electrical shock. If it is necessary to supply power to the equipment to conduct the repair or inspect the circuits, do not touch any electrically charged sections of the equipment.	
If refrigerant gas is discharged during repair work, do not touch the discharged refrigerant gas. Refrigerant gas may cause frostbite.	
When disconnecting the suction or discharge pipe of the compressor at the welded section, evacuate the refrigerant gas completely at a well-ventilated place first. If there is gas remaining inside the compressor, the refrigerant gas or refrigerating machine oil discharges when the pipe is disconnected, and it may cause injury.	
If refrigerant gas leaks during repair work, ventilate the area. Refrigerant gas may generate toxic gases when it contacts flames.	
Be sure to discharge the capacitor completely before conducting repair work. The step-up capacitor supplies high-voltage electricity to the electrical components of the outdoor unit. A charged capacitor may cause an electrical shock.	









 Warning	
<p>Do not turn the air conditioner on or off by plugging in or unplugging the power cable. Plugging in or unplugging the power cable to operate the equipment may cause an electrical shock or fire.</p>	
<p>Be sure to wear a safety helmet, gloves, and a safety belt when working in a high place (more than 2 m). Insufficient safety measures may cause a fall.</p>	
<p>In case of R-32 / R-410A refrigerant models, be sure to use pipes, flare nuts and tools intended for the exclusive use with the R-32 / R-410A refrigerant. The use of materials for R-22 refrigerant models may cause a serious accident, such as a damage of refrigerant cycle or equipment failure.</p>	
<p>Do not mix air or gas other than the specified refrigerant (R-32 / R-410A / R-22) in the refrigerant system. If air enters the refrigerant system, an excessively high pressure results, causing equipment damage and injury.</p>	









 Caution	
<p>Do not repair electrical components with wet hands. Working on the equipment with wet hands may cause an electrical shock.</p>	
<p>Do not clean the air conditioner with water. Washing the unit with water may cause an electrical shock.</p>	
<p>Be sure to provide an earth / grounding when repairing the equipment in a humid or wet place, to avoid electrical shocks.</p>	
<p>Be sure to turn off the power switch and unplug the power cable when cleaning the equipment. The internal fan rotates at a high speed, and may cause injury.</p>	
<p>Be sure to conduct repair work with appropriate tools. The use of inappropriate tools may cause injury.</p>	

 Caution	
Be sure to check that the refrigerating cycle section has cooled down enough before conducting repair work. Working on the unit when the refrigerating cycle section is hot may cause burns.	
Conduct welding work in a well-ventilated place. Using a welder in an enclosed room may cause oxygen deficiency.	

1.2 Warnings and Cautions Regarding Safety of Users





 Warning	
Do not store the equipment in a room with fire sources (e.g., naked flames, gas appliances, electric heaters).	
Be sure to use parts listed in the service parts list of the applicable model and appropriate tools to conduct repair work. Never attempt to modify the equipment. The use of inappropriate parts or tools may cause an electrical shock, excessive heat generation or fire.	
If the power cable and lead wires are scratched or have deteriorated, be sure to replace them. Damaged cable and wires may cause an electrical shock, excessive heat generation or fire.	
Do not use a joined power cable or extension cable, or share the same power outlet with other electrical appliances, since it may cause an electrical shock, excessive heat generation or fire.	
Be sure to use an exclusive power circuit for the equipment, and follow the local technical standards related to the electrical equipment, the internal wiring regulations, and the instruction manual for installation when conducting electrical work. Insufficient power circuit capacity and improper electrical work may cause an electrical shock or fire.	
Be sure to use the specified cable for wiring between the indoor and outdoor units. Make the connections securely and route the cable properly so that there is no force pulling the cable at the connection terminals. Improper connections may cause excessive heat generation or fire.	

 Warning	
<p>When wiring between the indoor and outdoor units, make sure that the terminal cover does not lift off or dismount because of the cable. If the cover is not mounted properly, the terminal connection section may cause an electrical shock, excessive heat generation or fire.</p>	
<p>Do not damage or modify the power cable. Damaged or modified power cables may cause an electrical shock or fire. Placing heavy items on the power cable, or heating or pulling the power cable may damage it.</p>	
<p>Do not mix air or gas other than the specified refrigerant (R-32 / R-410A / R-22) in the refrigerant system. If air enters the refrigerant system, an excessively high pressure results, causing equipment damage and injury.</p>	
<p>If the refrigerant gas leaks, be sure to locate the leaking point and repair it before charging the refrigerant. After charging the refrigerant, make sure that there is no leak. If the leaking point cannot be located and the repair work must be stopped, be sure to pump-down, and close the service valve, to prevent refrigerant gas from leaking into the room. Refrigerant gas itself is harmless, but it may generate toxic gases when it contacts flames, such as those from fan type and other heaters, stoves and ranges.</p>	
<p>When relocating the equipment, make sure that the new installation site has sufficient strength to withstand the weight of the equipment. If the installation site does not have sufficient strength or the installation work is not conducted securely, the equipment may fall and cause injury.</p>	
<p>Check to make sure that the power cable plug is not dirty or loose, then insert the plug into a power outlet securely. If the plug is dusty or has a loose connection, it may cause an electrical shock or fire.</p>	
<p>When replacing the coin battery in the remote controller, be sure to dispose of the old battery to prevent children from swallowing it. If a child swallows the coin battery, see a doctor immediately.</p>	

 Caution	
<p>Installation of a leakage breaker is necessary in some cases depending on the conditions of the installation site, to prevent electrical shocks.</p>	
<p>Do not install the equipment in a place where there is a possibility of combustible gas leaks. If combustible gas leaks and remains around the unit, it may cause a fire.</p>	
<p>Check to see if parts and wires are mounted and connected properly, and if connections at the soldered or crimped terminals are secure. Improper installation and connections may cause excessive heat generation, fire or an electrical shock.</p>	
<p>If the installation platform or frame has corroded, replace it. A corroded installation platform or frame may cause the unit to fall, resulting in injury.</p>	
<p>Check the earth / grounding, and repair it if the equipment is not properly earthed / grounded. Improper earth / grounding may cause an electrical shock.</p>	
<p>Be sure to measure insulation resistance after the repair, and make sure that the resistance is 1 MΩ or higher. Faulty insulation may cause an electrical shock.</p>	
<p>Be sure to check the drainage of the indoor unit after the repair. Faulty drainage may cause water to enter the room and wet the furniture and floor.</p>	
<p>Do not tilt the unit when removing it. The water inside the unit may spill and wet the furniture and floor.</p>	

2. Icons Used

The following icons are used to attract the attention of the reader to specific information.

Icon	Type of Information	Description
 Warning	Warning	A Warning is used when there is danger of personal injury.
 Caution	Caution	A Caution is used when there is danger that the reader, through incorrect manipulation, may damage equipment, lose data, get an unexpected result or have to restart (part of) a procedure.
 Note:	Note	A Note provides information that is not indispensable, but may nevertheless be valuable to the reader, such as tips and tricks.
	Reference	A Reference guides the reader to other places in this binder or in this manual, where he/she will find additional information on a specific topic.

Part 1

List of Functions

1. Functions.....2

1. Functions

Category	Functions	FTX30/36NVJU RK30/36NMVJU	FTX30/36NVJU RX30/36NMVJU	Category	Functions	FTX30/36NVJU RK30/36NMVJU	FTX30/36NVJU RX30/36NMVJU	
Basic Functions	Inverter (with inverter power control)	●	●	Health & Cleanliness	Air-purifying filter	—	—	
	Operation limit for cooling	Refer to P. 117			Titanium apatite deodorizing filter	●	●	
	Operation limit for heating				Air filter (prefilter)	●	●	
	PAM control	●	●		Wipe-clean flat panel	●	●	
	Standby electricity saving	●	●		Washable grille	—	—	
Compressor	Oval scroll compressor	—	—	Timer	MOLD PROOF operation	—	—	
	Swing compressor	●	●		WEEKLY TIMER	●	●	
	Rotary compressor	—	—		Count up-down ON/OFF timer	—	—	
	Reluctance DC motor	●	●		24-hour ON/OFF TIMER	●	●	
Comfortable Airflow	Power-airflow flap (horizontal blade)	—	—	Worry Free (Reliability & Durability)	NIGHT SET mode	●	●	
	Power-airflow dual flaps (horizontal blade)	●	●		Auto-restart (after power failure)	●	●	
	Power-airflow diffuser	—	—		Self-diagnosis (R/C, LED)	●	●	
	Wide-angle louvers (vertical blade)	●	●		Wiring error check function	—	—	
	Auto-swing (up and down)	●	●	Flexibility	Anti-corrosion treatment of outdoor heat exchanger	●	●	
	Auto-swing (right and left)	●	●		Multi-split/split type compatible indoor unit	—	—	
	3-D airflow	●	●		H/P, C/O compatible indoor unit	●	●	
	COMFORT AIRFLOW operation	●	●		Flexible power supply correspondence	—	—	
Comfort Control	Auto fan speed	●	●	Remote Control	Chargeless	32.8 ft (10 m)	32.8 ft (10 m)	
	Indoor unit quiet operation	●	●		Either side drain (right or left)	●	●	
	NIGHT QUIET mode (automatic)	—	—		Power selection	—	—	
	OUTDOOR UNIT QUIET operation (manual)	●	●		Low temperature cooling operation (–10°C) (14°F)	●★1	●★2	
	INTELLIGENT EYE operation	●	●		°F/°C changeover R/C temperature display (factory setting: °F)	●	●	
	Quick warming function	—	●		Remote Controller	Remote control adaptor (normal open-pulse contact) (option)	●	●
	Hot-start function	—	●			Remote control adaptor (normal open contact) (option)	●	●
	Automatic defrosting	—	●			DIII-NET compatible (adaptor) (option)	●	●
Operation	Automatic operation	—	●	Remote Controller	Wireless	●	●	
	Program dry function	●	●		Wired (option)	●	●	
	Fan only	●	●					
Lifestyle Convenience	POWERFUL operation (non-inverter)	—	—					
	POWERFUL operation (inverter)	●	●					
	Priority-room setting	—	—					
	COOL/HEAT mode lock	—	—					
	HOME LEAVE operation	—	—					
	ECONO operation	●	●					
	Indoor unit ON/OFF button	●	●					
	Signal receiving sign	●	●					
	R/C with back light	●	●					
Temperature display	—	—						

Note: ● : Available
— : Not available

★1 Extend operation range to –30°C (–22°F) with an air direction adjustment grille (sold separately).

★2 Extend operation range to –20°C (–4°F) with an air direction adjustment grille (sold separately).

Part 2

Specifications

1. Specifications	4
1.1 Cooling Only	4
1.2 Heat Pump	5

1. Specifications

1.1 Cooling Only

60 Hz, 208 - 230 V

Model	Indoor Unit		FTX30NVJU		FTX36NVJU	
	Outdoor Unit		RK30NMVJU		RK36NMVJU	
Capacity	Rated	Btu/h	31,400 - 31,400		33,200 - 34,400	
	Min. ~ Max.	Btu/h	10,200 - 10,200 ~ 31,400 - 31,400		10,200 - 10,200 ~ 33,200 - 34,400	
Running Current (Rated)		A	15.7 - 14.2		17 - 17	
Power Consumption	Rated	W	3,188 - 3,188		3,458 - 3,780	
	Min. ~ Max.	W	610 - 610 ~ 3,188 - 3,188		620 - 620 ~ 3,458 - 3,780	
Power Factor (Rated)		%	97.6 - 97.6		97.8 - 96.7	
COP (Rated)		W/W	—		—	
EER (Rated)		Btu/W·h	9.85		9.6 - 9.1	
SEER / HSPF			17.50		15.90	
Piping Connections	Liquid	in. (mm)	φ 1/4 (φ 6.4)		φ 1/4 (φ 6.4)	
	Gas	in. (mm)	φ 5/8 (φ 15.9)		φ 5/8 (φ 15.9)	
	Drain	in. (mm)	φ 5/8 (φ 16.0)		φ 5/8 (φ 16.0)	
Heat Insulation			Both Liquid and Gas Pipes		Both Liquid and Gas Pipes	
Max. Interunit Piping Length		ft (m)	98-3/8 (30)		98-3/8 (30)	
Max. Interunit Height Difference		ft (m)	65-5/8 (20)		65-5/8 (20)	
Chargeless		ft (m)	32-13/16 (10)		32-13/16 (10)	
Amount of Additional Charge of Refrigerant		oz/ft (g/m)	0.32 (30)		0.32 (30)	
Indoor Unit			FTX30NVJU		FTX36NVJU	
Front Panel Color			White		White	
Airflow Rate	H	cfm (m³/min)	890 (25.2)		915 (25.9)	
	M		727 (20.6)		742 (21.0)	
	L		572 (16.2)		572 (16.2)	
	SL		512 (14.5)		512 (14.5)	
Fan	Type	Cross Flow Fan		Cross Flow Fan		
	Speed	Steps	5 Steps, Quiet, Auto		5 Steps, Quiet, Auto	
Air Direction Control			Right, Left, Horizontal, Downward		Right, Left, Horizontal, Downward	
Air Filter			Removable, Washable, Mildew Proof		Removable, Washable, Mildew Proof	
Running Current (Rated)		A	0.8 - 0.7		0.8 - 0.8	
Power Consumption (Rated)		W	90.0 - 90.0		95.0 - 95.0	
Power Factor (Rated)		%	56.2 - 55.9		55.7 - 55.1	
Temperature Control			Microcomputer Control		Microcomputer Control	
Dimensions (H x W x D)		in. (mm)	13-3/8 x 47-1/4 x 10-3/16 (340 x 1,200 x 259)		13-3/8 x 47-1/4 x 10-3/16 (340 x 1,200 x 259)	
Packaged Dimensions (H x W x D)		in. (mm)	13-7/16 x 51-9/16 x 16-7/8 (342 x 1,310 x 429)		13-7/16 x 51-9/16 x 16-7/8 (342 x 1,310 x 429)	
Weight (Mass)		Lbs (kg)	38 (17)		38 (17)	
Gross Weight (Gross Mass)		Lbs (kg)	49 (22)		49 (22)	
Sound Pressure Level	H / M / L / SL	dB(A)	53 / 47 / 40 / 37		54 / 47 / 40 / 37	
Outdoor Unit			RK30NMVJU		RK36NMVJU	
Casing Color			Ivory White		Ivory White	
Compressor	Type	Hermetically Sealed Swing Type		Hermetically Sealed Swing Type		
	Model	2YC63AAXD		2YC63AAXD		
	Motor Output	W	1,920		1,920	
Refrigerant Oil	Type	FVC50K		FVC50K		
	Charge	oz (L)	30.44 (0.900)		30.44 (0.900)	
Refrigerant	Type	R-410A		R-410A		
	Charge	Lbs (kg)	3.64 (1.65)		3.64 (1.65)	
Airflow Rate	H	cfm (m³/min)	2,528 (71.6)		2,811 (79.6)	
	SL		—		—	
Fan	Type	Propeller		Propeller		
Running Current (Rated)		A	14.93 - 13.50		16.18 - 16.25	
Power Consumption (Rated)		W	3,098 - 3,098		3,363 - 3,685	
Power Factor (Rated)		%	99.8 - 99.8		99.9 - 98.6	
Starting Current		A	15.70		17.00	
Dimensions (H x W x D)		in. (mm)	28-15/16 x 34-1/4 x 12-5/8 (735 x 870 x 320)		28-15/16 x 34-1/4 x 12-5/8 (735 x 870 x 320)	
Packaged Dimensions (H x W x D)		in. (mm)	31-7/8 x 41-9/16 x 18-1/4 (810 x 1,056 x 464)		31-7/8 x 41-9/16 x 18-1/4 (810 x 1,056 x 464)	
Weight (Mass)		Lbs (kg)	133 (60)		133 (60)	
Weight (Gross Mass)		Lbs (kg)	142 (64)		142 (64)	
Sound Pressure Level	H	dB(A)	56		59	
Drawing No.			3D107929		3D107930	

- Notes:**
1. SL: The Quiet fan level of the airflow rate setting.
 2. The data are based on the conditions shown in the table below.

Cooling	Indoor ; 80.0°FDB (26.7°CDB) / 67.0°FWB (19.4°CWB) Outdoor ; 95.0°FDB (35°CDB) / 75°FWB (23.9°CWB)
Heating	Indoor ; 70.0°FDB (21.1°CDB) / 60.0°FWB (15.6°CWB) Outdoor ; 47°FDB (8.33°CDB) / 43.0°FWB (6.11°CWB)
Piping Length	25 ft (7.5 m)

Conversion Formulae
kcal/h = kW x 860
Btu/h = kW x 3412
cfm = m³/min x 35.3

1.2 Heat Pump

60 Hz, 208 - 230V

Model	Indoor Unit		FTX30NVJU		FTX36NVJU	
	Outdoor Unit		RX30NMVJU		RX36NMVJU	
			Cooling	Heating	Cooling	Heating
Capacity	Rated	Btu/h	31,400 - 31,400	34,800 - 34,800	33,200 - 34,400	35,200 - 36,000
	Min. ~ Max.	Btu/h	10,200 - 10,200 ~ 31,400 - 31,400	10,200 - 10,200 ~ 34,800 - 34,800	10,200 - 10,200 ~ 33,200 - 34,400	10,200 - 10,200 ~ 35,200 - 36,000
Running Current (Rated)		A	15.7 - 14.2	17.3 - 15.6	17 - 17	18.1 - 17
Power Consumption	Rated	W	3,188 - 3,188	3,490 - 3,490	3,458 - 3,780	3,686 - 3,799
	Min. ~ Max.	W	610 - 610 ~ 3,188 - 3,188	690 - 690 ~ 3,490 - 3,490	620 - 620 ~ 3,458 - 3,780	690 - 690 ~ 3,686 - 3,799
Power Factor (Rated)		%	97.6 - 97.6	97.0 - 97.3	97.8 - 96.7	97.9 - 97.2
COP (Rated)		W/W	—	2.92	—	2.80 - 2.78
EER (Rated)		Btu/W-h	9.85	—	9.6 - 9.1	—
SEER / HSPF			17.50	9.30	15.90	9.20
Piping Connections	Liquid	in. (mm)	ϕ 1/4 (ϕ 6.4)		ϕ 1/4 (ϕ 6.4)	
	Gas	in. (mm)	ϕ 5/8 (ϕ 15.9)		ϕ 5/8 (ϕ 15.9)	
	Drain	in. (mm)	ϕ 5/8 (ϕ 16.0)		ϕ 5/8 (ϕ 16.0)	
Heat Insulation			Both Liquid and Gas Pipes		Both Liquid and Gas Pipes	
Max. Interunit Piping Length		ft (m)	98-3/8 (30)		98-3/8 (30)	
Max. Interunit Height Difference		ft (m)	65-5/8 (20)		65-5/8 (20)	
Chargeless		ft (m)	32-13/16 (10)		32-13/16 (10)	
Amount of Additional Charge of Refrigerant		oz/ft (g/m)	0.32 (30)		0.32 (30)	
Indoor Unit			FTX30NVJU		FTX36NVJU	
Front Panel Color			White		White	
Airflow Rate	H	cfm (m ³ /min)	890 (25.2)	960 (27.2)	915 (25.9)	960 (27.2)
	M		727 (20.6)	791 (22.4)	742 (21.0)	791 (22.4)
	L		572 (16.2)	629 (17.8)	572 (16.2)	629 (17.8)
	SL		512 (14.5)	544 (15.4)	512 (14.5)	544 (15.4)
Fan	Type		Cross Flow Fan		Cross Flow Fan	
	Speed	Steps	5 Steps, Quiet, Auto		5 Steps, Quiet, Auto	
Air Direction Control			Right, Left, Horizontal, Downward		Right, Left, Horizontal, Downward	
Air Filter			Removable, Washable, Mildew Proof		Removable, Washable, Mildew Proof	
Running Current (Rated)		A	0.77 - 0.70	0.82 - 0.75	0.82 - 0.75	0.82 - 0.75
Power Consumption (Rated)		W	90.0 - 90.0	95.0 - 95.0	95.0 - 95.0	95 - 95
Power Factor (Rated)		%	56.2 - 55.9	55.7 - 55.1	55.7 - 55.1	55.7 - 55.1
Temperature Control			Microcomputer Control		Microcomputer Control	
Dimensions (H x W x D)		in. (mm)	13-3/8 x 47-1/4 x 10-3/16 (340 x 1,200 x 259)		13-3/8 x 47-1/4 x 10-3/16 (340 x 1,200 x 259)	
Packaged Dimensions (H x W x D)		in. (mm)	13-7/16 x 51-9/16 x 16-7/8 (342 x 1,310 x 429)		13-7/16 x 51-9/16 x 16-7/8 (342 x 1,310 x 429)	
Weight (Mass)		Lbs (kg)	38 (17)		38 (17)	
Gross Weight (Gross Mass)		Lbs (kg)	49 (22)		49 (22)	
Sound Pressure Level	H / M / L / SL	dB(A)	53 / 47 / 40 / 37		53 / 46 / 38 / 35	
Outdoor Unit			RX30NMVJU		RX36NMVJU	
Casing Color			Ivory White		Ivory White	
Compressor	Type		Hermetically Sealed Swing Type		Hermetically Sealed Swing Type	
	Model		2YC63AAXD		2YC63AAXD	
Refrigerant Oil	Motor Output	W	1,920		1,920	
	Type		FVC50K		FVC50K	
Refrigerant	Charge	oz (L)	30.44 (0.900)		30.44 (0.900)	
	Type		R-410A		R-410A	
Airflow Rate	Charge	Lbs (kg)	3.64 (1.65)		3.64 (1.65)	
	H	cfm (m ³ /min)	2,528 (71.6)	2,274 (64.4)	2,811 (79.6)	2,352 (66.6)
Fan	SL		—		—	
	Type		Propeller		Propeller	
Running Current (Rated)		A	14.93 - 13.50	16.48 - 14.85	16.18 - 16.25	17.28 - 16.25
Power Consumption (Rated)		W	3,098 - 3,098	3,395 - 3,395	3,363 - 3,685	3,591 - 3,704
Power Factor (Rated)		%	99.8 - 99.8	99.0 - 99.4	99.9 - 98.6	99.9 - 99.1
Starting Current		A	17.30		18.10	
Dimensions (H x W x D)		in. (mm)	28-15/16 x 34-1/4 x 12-5/8 (735 x 870 x 320)		28-15/16 x 34-1/4 x 12-5/8 (735 x 870 x 320)	
Packaged Dimensions (H x W x D)		in. (mm)	31-7/8 x 41-9/16 x 18-1/4 (810 x 1,056 x 464)		31-7/8 x 41-9/16 x 18-1/4 (810 x 1,056 x 464)	
Weight (Mass)		Lbs (kg)	133 (60)		133 (60)	
Gross Weight (Gross Mass)		Lbs (kg)	142 (64)		142 (64)	
Sound Pressure Level	H	dB(A)	56	58	59	59
Drawing No.			3D107927		3D107928	

Notes:

1. SL: The Quiet fan level of the airflow rate setting.
2. The data are based on the conditions shown in the table below.

Cooling	Indoor ; 80.0°FDB (26.7°CDB) / 67.0°FWB (19.4°CWB) Outdoor ; 95.0°FDB (35°CDB) / 75°FWB (23.9°CWB)
Heating	Indoor ; 70.0°FDB (21.1°CDB) / 60.0°FWB (15.6°CWB) Outdoor ; 47°FDB (8.33°CDB) / 43.0°FWB (6.11°CWB)
Piping Length	25 ft (7.5 m)

Conversion Formulae
kcal/h = kW × 860
Btu/h = kW × 3412
cfm = m ³ /min × 35.3

Part 3

Printed Circuit Board

Connector Wiring Diagram

1. Indoor Unit.....	7
1.1 FTX30/36NVJU	7
2. Outdoor Unit.....	9
2.1 RK(X)30/36NMVJU	9

1. Indoor Unit

1.1 FTX30/36NVJU

Control PCB (PCB1)

- | | |
|-----------------------------|--|
| 1) S1 | Connector for DC fan motor |
| 2) S21 | Connector for centralized control (HA) |
| 3) S25 | Connector for INTELLIGENT EYE sensor PCB (PCB4) |
| 4) S32 | Indoor heat exchanger thermistor |
| 5) S41 | Connector for swing motors |
| 6) S46 | Connector for display PCB (PCB3) |
| 7) S47 | Connector for signal receiver PCB (PCB2) |
| 8) H1, H2, H3, FG | Connector for terminal strip |
| 9) JA | Address setting jumper |
| | * Refer to page 108 for details. |
| 10) JB | Fan speed setting when compressor stops for thermostat OFF
(effective only for cooling operation) |
| | * Refer to page 108 for details. |
| 11) JC | Power failure recovery function (auto-restart) |
| | * Refer to page 108 for details. |
| 12) LED A | LED for service monitor (green) |
| 13) FU1 (F1U),
FU2 (F2U) | Fuse (3.15 A, 250 V) |
| 14) V1 | Varistor |

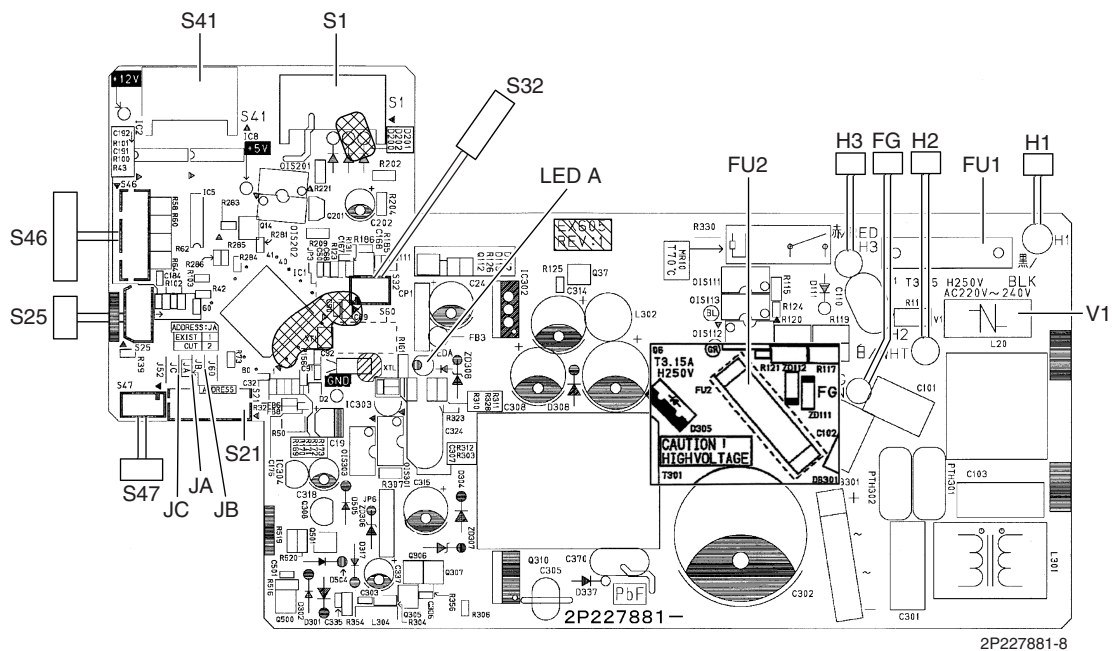

Caution

Replace the PCB if you accidentally cut a wrong jumper.

Jumpers are necessary for electronic circuit. Improper operation may occur if you cut any of them.



Note:

The symbols in the parenthesis are the names on the appropriate wiring diagram.

Signal Receiver PCB (PCB2)

- 1) S48 Connector for control PCB (PCB1)

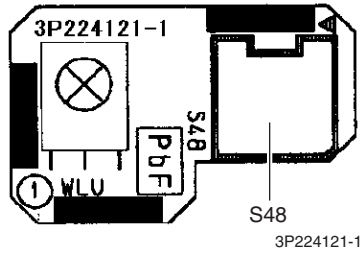

Display PCB (PCB3)

- 1) S49 Connector for control PCB (PCB1)
- 2) SW1 Indoor unit **ON/OFF** button
- 3) LED1 (H1P) LED for operation (green)
- 4) LED2 (H2P) LED for timer (yellow)
- 5) LED3 (H3P) LED for INTELLIGENT EYE (green)
- 6) RTH1 (R1T) Room temperature thermistor

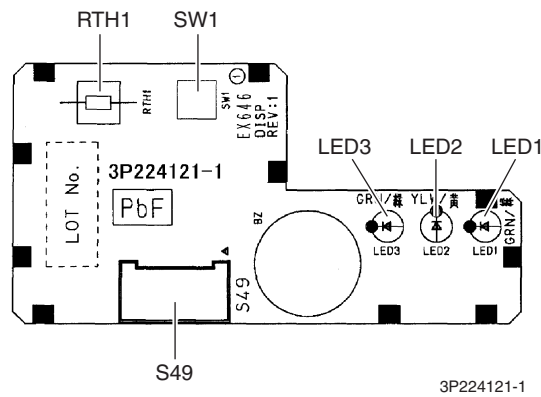

INTELLIGENT EYE Sensor PCB (PCB4)

- 1) S36 Connector for control PCB (PCB1)

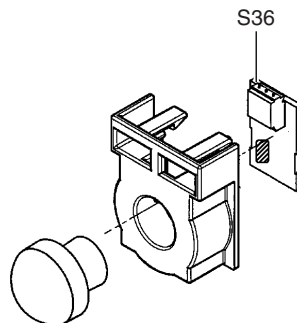

3P227885-1

i Note: The symbols in the parenthesis are the names on the appropriate wiring diagram.

2. Outdoor Unit

2.1 RK(X)30/36NMVJU

Main PCB (PCB1)

1) S	Connector for terminal block (indoor - outdoor transmission)
2) S20 (white)	Connector for electronic expansion valve coil
3) S40	Connector for overload protector
4) S70	Connector for DC fan motor
5) S80	Connector for four way valve coil (heat pump models only)
6) S90	Connector for thermistors (outdoor temperature, outdoor heat exchanger, discharge pipe)
7) S201, S202	Connector for service monitor PCB (PCB2)
8) CK1	Connector for voltage endurance test
9) HL1, HN1	Connector for terminal block (power supply)
10) E1, E2	Connector for ground wire
11) U, V, W	Connector for compressor
12) FU1, FU2	Fuse (3.15 A, 250 V)
13) FU3	Fuse (30 A, 250 V)
14) V2, V3, V401	Varistor

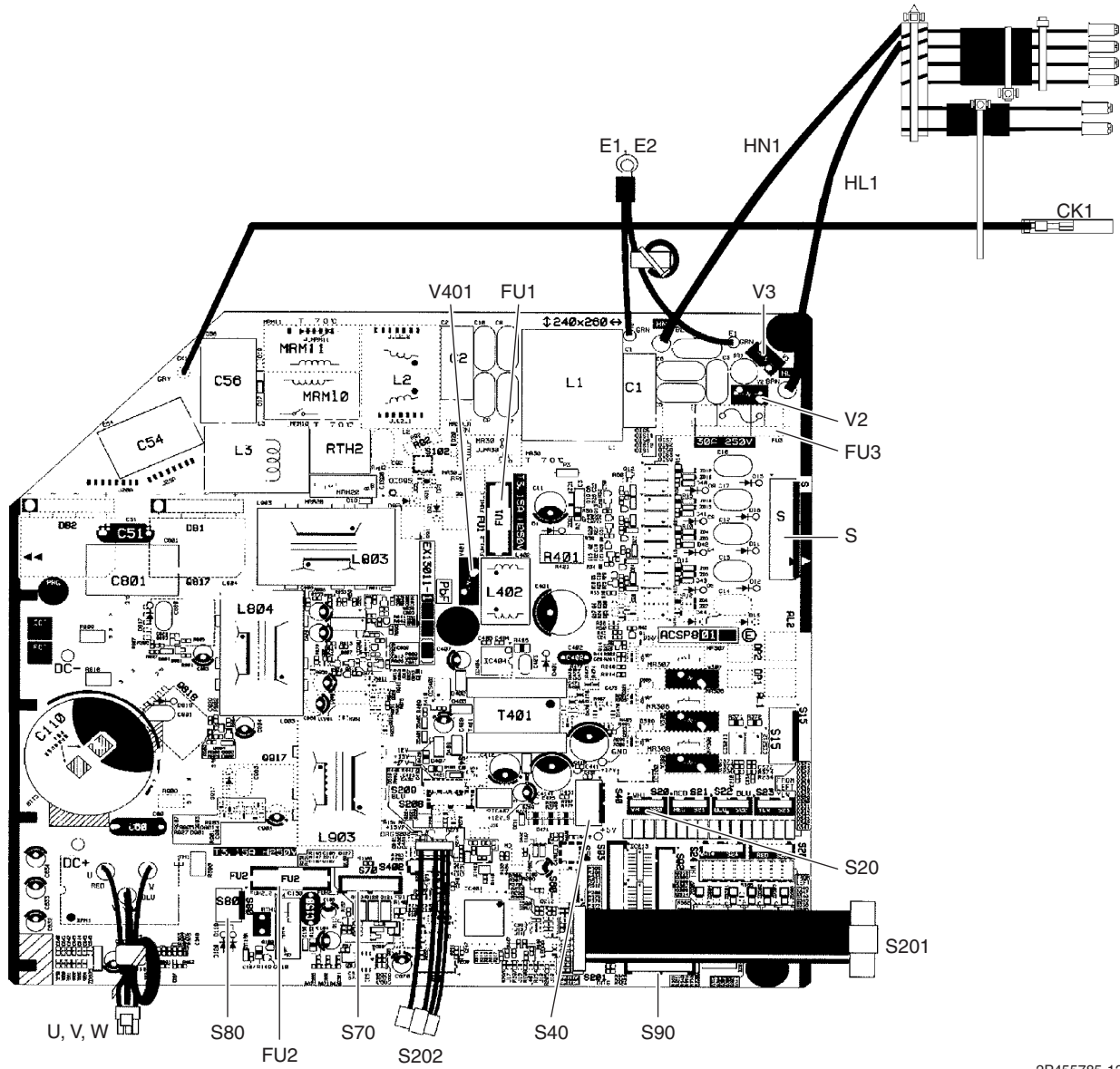

2P455785-13

**Service Monitor
PCB (PCB2)**

- | | |
|---|---|
| <ul style="list-style-type: none"> 1) S501, S502 2) LED A 3) SW5-3 4) SW6-2 | <p>Connector for main PCB (PCB1)</p> <p>LED for service monitor (green)</p> <p>Switch for facility setting
* Refer to page 109 for details.</p> <p>Switch for facility setting
* Refer to page 109 for details.</p> |
|---|---|

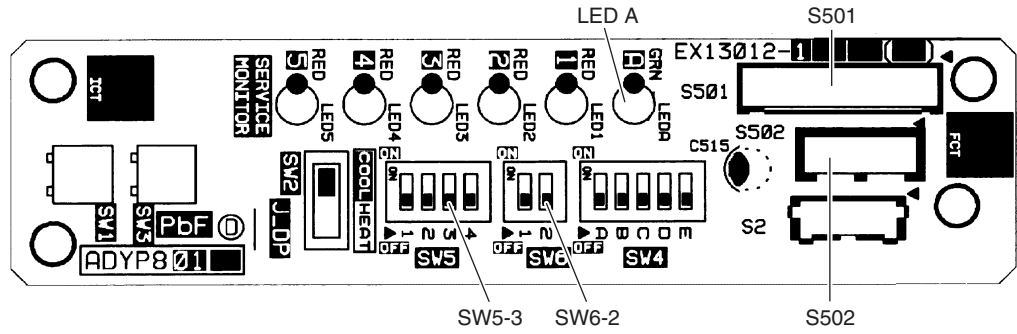

★ SW1 ~ SW4 and LED1 ~ LED5 do not work.

Part 4

Functions and Control

1. Main Functions	13
1.1 Temperature Control	13
1.2 Frequency Principle.....	13
1.3 Airflow Direction Control.....	15
1.4 Fan Speed Control for Indoor Unit	16
1.5 Program Dry Operation	17
1.6 Automatic Operation.....	18
1.7 Thermostat Control.....	19
1.8 NIGHT SET Mode	20
1.9 ECONO Operation	20
1.10 INTELLIGENT EYE Operation	21
1.11 POWERFUL Operation	22
1.12 Clock Setting	23
1.13 WEEKLY TIMER Operation	24
1.14 Other Functions.....	30
2. Thermistor Functions	31
3. Control Specification	33
3.1 Mode Hierarchy	33
3.2 Frequency Control.....	34
3.3 Controls at Mode Changing/Start-up.....	36
3.4 Discharge Pipe Temperature Control.....	38
3.5 Input Current Control.....	39
3.6 Freeze-up Protection Control	40
3.7 Heating Peak-cut Control	40
3.8 Outdoor Fan Control.....	41
3.9 Liquid Compression Protection Function.....	41
3.10 Defrost Control	42
3.11 Electronic Expansion Valve Control	43
3.12 Malfunctions	46

1. Main Functions

1.1 Temperature Control

Definitions of Temperatures

The definitions of temperatures are classified as following.

- ◆ Room temperature: temperature of lower part of the room
- ◆ Set temperature: temperature set by remote controller
- ◆ Room thermistor temperature: temperature detected by room temperature thermistor
- ◆ Target temperature: temperature determined by microcomputer

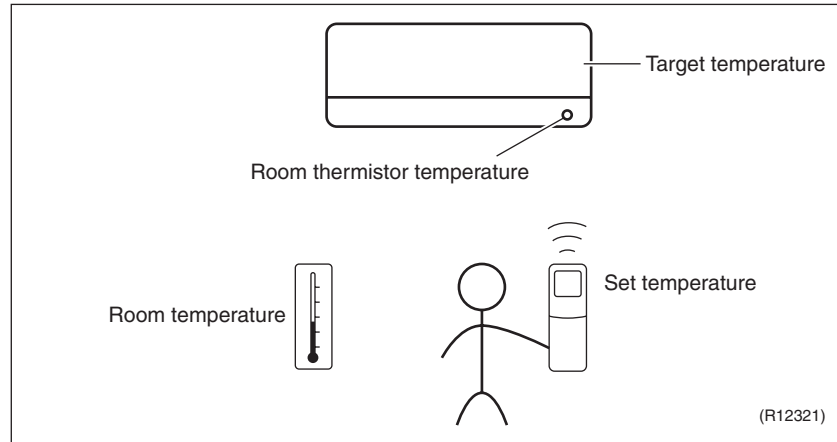

Temperature Control

The temperature of the room is detected by the room temperature thermistor. However, there is a difference between the temperature detected by room temperature thermistor and the temperature of lower part of the room, depending on the type of the indoor unit or installation condition. Practically, the temperature control is done by the target temperature appropriately adjusted for the indoor unit and the temperature detected by room temperature thermistor.

1.2 Frequency Principle

Control Parameters

The frequency of the compressor is controlled by the following 2 parameters:

- The load condition of the operating indoor unit
- The difference between the room thermistor temperature and the target temperature

The target frequency is adapted by additional parameters in the following cases:

- Frequency restrictions
- Initial settings
- Forced cooling operation

Inverter Principle

To regulate the capacity, a frequency control is needed. The inverter makes it possible to control the rotation speed of the compressor. The following table explains the inverter principle:

Phase	Description
1	The supplied AC power source is converted into the DC power source for the present.
2	The DC power source is reconverted into the three phase AC power source with variable frequency. <ul style="list-style-type: none"> ■ When the frequency increases, the rotation speed of the compressor increases resulting in an increase of refrigerant circulation. This leads to a larger amount of heat exchange per unit. ■ When the frequency decreases, the rotation speed of the compressor decreases resulting in a decrease of refrigerant circulation. This leads to a smaller amount of heat exchange per unit.

The following drawing shows a schematic view of the inverter principle:

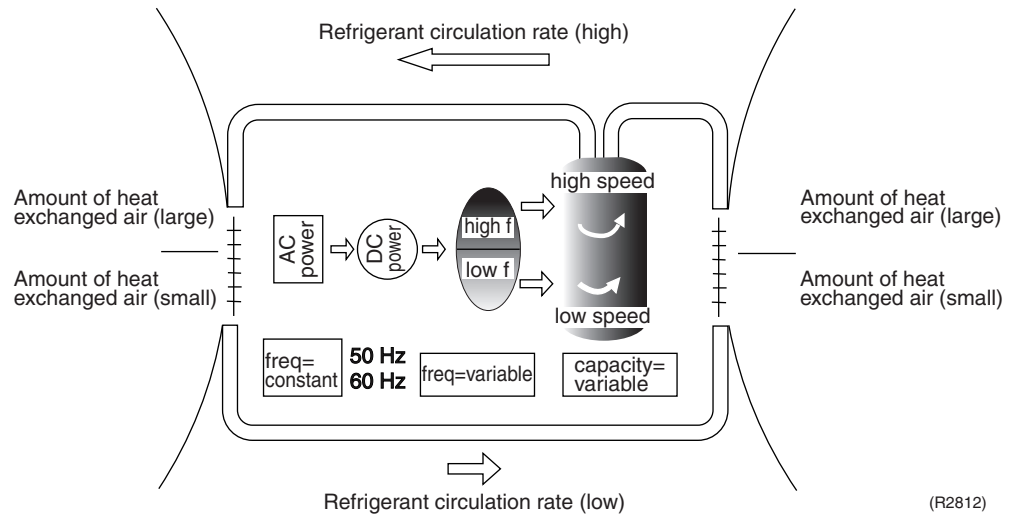

Inverter Features

The inverter provides the following features:

- The regulating capacity can be changed according to the changes in the outdoor temperature and cooling/heating load.
- Quick heating and quick cooling
The rotation speed of the compressor is increased when starting the heating (or cooling). This enables to reach the set temperature quickly.
- Even during extreme cold weather, high capacity is achieved. It is maintained even when the outdoor temperature is 2°C (35.6 °F).
- Comfortable air conditioning
A fine adjustment is integrated to keep the room temperature constant.
- Energy saving heating and cooling
Once the set temperature is reached, the energy saving operation enables to maintain the room temperature at low power.

Frequency Limits

The following functions regulate the minimum and maximum frequency:

Frequency	Functions
Low	<ul style="list-style-type: none"> ■ Four way valve operation compensation. Refer to page 36.
High	<ul style="list-style-type: none"> ■ Compressor protection function. Refer to page 37. ■ Discharge pipe temperature control. Refer to page 38. ■ Input current control. Refer to page 39. ■ Freeze-up protection control. Refer to page 40. ■ Heating peak-cut control. Refer to page 40. ■ Defrost control. Refer to page 42.

Forced Cooling Operation

Refer to page 105 for details.

1.3 Airflow Direction Control

Power-Airflow Dual Flaps

The large flap sends a large volume of air downward to the floor and provides an optimum control in cooling, dry, and heating operation.

Cooling/Dry

During cooling or dry operation, the flap retracts into the indoor unit. Then, cool air can be blown far and distributed all over the room.

Heating

During heating operation, the large flap directs airflow downward to spread the warm air to the entire room.

Wide-Angle Louvers

The louvers, made of elastic synthetic resin, provide a wide range of airflow that guarantees comfortable air distribution.

Auto-Swing

The following table explains the auto-swing process for cooling, dry, heating, and fan:

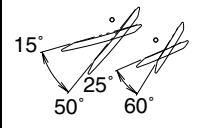
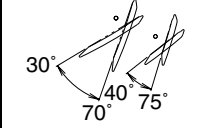
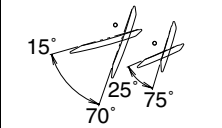
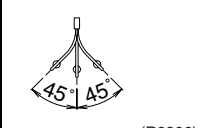
Flap (up and down)			Louver (right and left)
Cooling/Dry	Heating	Fan	
 (R9303)	 (R9304)	 (R9305)	 (R9306)

3-D Airflow

Alternative repetition of vertical and horizontal swing motions enables uniform air-conditioning of the entire room.

When the horizontal swing and vertical swing are both set to automatic operation, the airflow becomes 3-D airflow. The horizontal and vertical swing motions are alternated and the airflow direction changes in the order shown in the following diagram.

- (1) The louvers move from the right to the left.
- (2) The flaps move downward.
- (3) The louvers move from the left to the right.
- (4) The flaps move upward.

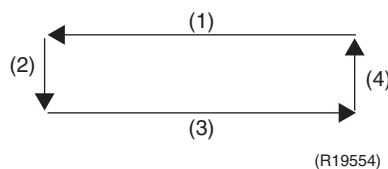

COMFORT AIRFLOW Operation

The airflow direction is upward while in cooling and dry operation, and downward while in heating operation. This function prevents cold or warm air from blowing directly on the occupants in the room.

When COMFORT AIRFLOW operation is set, or the combination use of COMFORT AIRFLOW operation and INTELLIGENT EYE operation is set, the airflow rate will be set to AUTO. If the up and down airflow direction is selected, COMFORT AIRFLOW operation will be canceled. Priority is given to the function of whichever button is pressed last.



1.4 Fan Speed Control for Indoor Unit

Outline

Phase control and fan speed control contains 9 steps: LLL, LL, SL, L, ML, M, MH, H, and HH. The airflow rate can be automatically controlled depending on the difference between the room thermistor temperature and the target temperature.

Automatic Fan Speed Control

In automatic fan speed operation, the step SL is not available.

Step	Cooling	Heating
LLL	 (R11681)	 (R6834)
LL		
L		
ML		
M		
MH		
H		
HH (POWERFUL)		

 = The airflow rate is automatically controlled within this range when **FAN** button is set to automatic.

Cooling

The following drawing explains the principle of fan speed control for cooling.

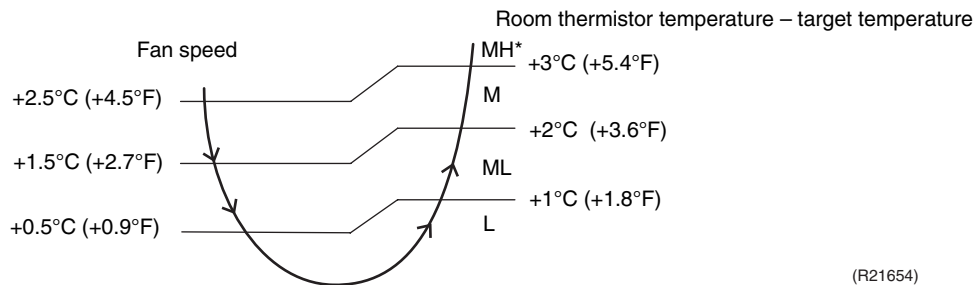

*The UPPER limit is M tap in 30 minutes from the operation start.

Heating

In heating operation, the fan speed is regulated according to the indoor heat exchanger temperature and the difference between the room thermistor temperature and the target temperature.



Note: The fan stops during defrost control.

COMFORT AIRFLOW Operation

- The fan speed is controlled automatically within the following steps.

Cooling

L tap ~ MH tap (same as automatic)

Heating

LL tap ~ M tap

1.5 Program Dry Operation

Outline

Program dry operation removes humidity while preventing the room temperature from lowering. Since the microcomputer controls both the temperature and airflow rate, the temperature adjustment and **FAN** setting buttons are inoperable.

Details

The microcomputer automatically sets the temperature and airflow rate. The difference between the room thermistor temperature at start-up and the target temperature is divided into two zones. Then, the unit operates in an appropriate capacity for each zone to maintain the temperature and humidity at a comfortable level.

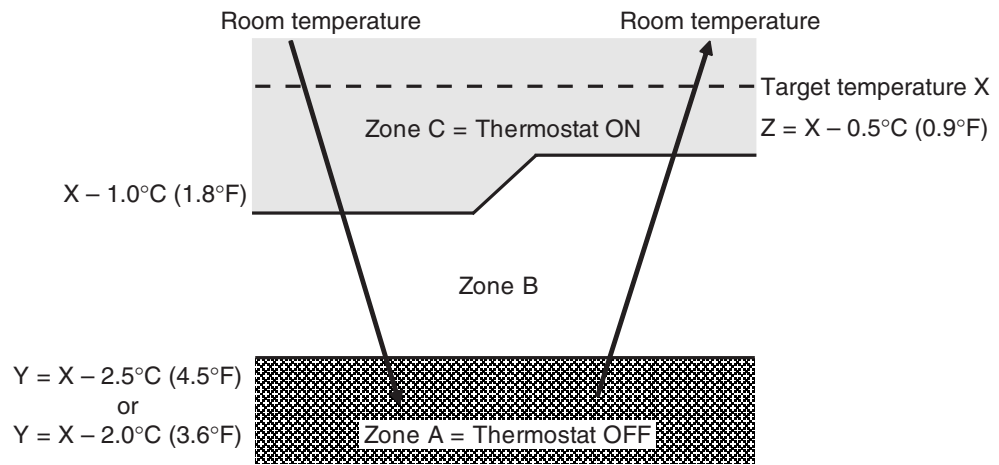

(R24029)

Room thermistor temperature at start-up	Target temperature X	Thermostat OFF point Y	Thermostat ON point Z ★
24°C or more (75.2°F or more)	Room thermistor temperature at start-up	X - 2.5°C (X - 4.5°F)	X - 0.5°C (X - 0.9°F)
18 ~ 23.5°C (64.4 ~ 74.3°F)		X - 2.0°C (X - 3.6°F)	X - 0.5°C (X - 0.9°F)
17.5°C or less (63.5°F or less)	18°C (64.4°F)	X - 2.0°C (X - 3.6°F)	X - 0.5°C = 17.5°C (X - 0.9°F = 63.5°F)

★ Thermostat turns on also when the room temperature is in the zone B for 10 minutes.

1.6 Automatic Operation

Outline

Automatic Cooling/Heating Function

When the automatic operation is selected with the remote controller, the microcomputer automatically determines the operation mode as cooling or heating according to the room temperature and the set temperature at start-up.

The unit automatically switches the operation mode to maintain the room temperature at the set temperature.

Details

Ts: set temperature (set by remote controller)

Tt: target temperature (determined by microcomputer)

Tr: room thermistor temperature (detected by room temperature thermistor)

C: correction value

- The set temperature (Ts) determines the target temperature (Tt).
(Ts = 18 ~ 30°C, 64 ~ 86°F).
- The target temperature (Tt) is calculated as:

$$Tt = Ts + C$$
 where C is the correction value.

$$C = 0^{\circ}\text{C} (0^{\circ}\text{F})$$
- Thermostat ON/OFF point and operation mode switching point are as follows.
 Tr means the room thermistor temperature.
 - Heating → Cooling switching point:

$$Tr \geq Tt + 3.0^{\circ}\text{C} (+5.4^{\circ}\text{F})$$
 - Cooling → Heating switching point:

$$Tr < Tt - 2.5^{\circ}\text{C} (-4.5^{\circ}\text{F})$$
 - Thermostat ON/OFF point is the same as the ON/OFF point of cooling or heating operation.
- During initial operation
 - $Tr \geq Ts$: Cooling operation
 - $Tr < Ts$: Heating operation

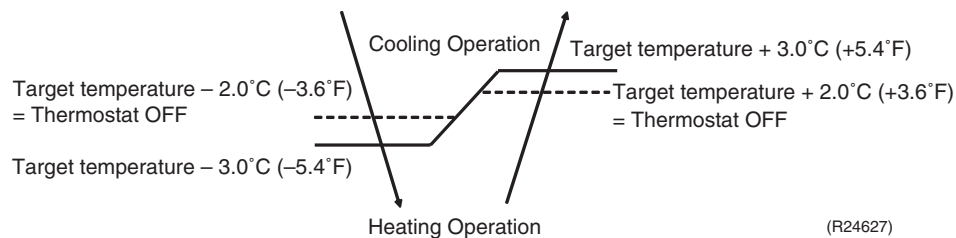

Ex: When the target temperature is 25°C (77°F)

Cooling → 23°C (73.4°F): Thermostat OFF → 22°C (71.6°F): Switch to heating

Heating → 27°C (80.6°F): Thermostat OFF → 28°C (82.4°F): Switch to cooling

1.7 Thermostat Control

Outline

Thermostat control is based on the difference between the room thermistor temperature and the target temperature.

Details

Thermostat OFF Condition

- ◆ The temperature difference is in the zone A.

Thermostat ON Conditions

- ◆ The temperature difference returns to the zone C after being in the zone A.
- ◆ The system resumes from defrost control in any zones except A.
- ◆ The operation turns on in any zones except A.
- ◆ The temperature difference remains in zone B for the determined monitoring time.
(Cooling: 10 minutes, Heating: 10 seconds)

Cooling

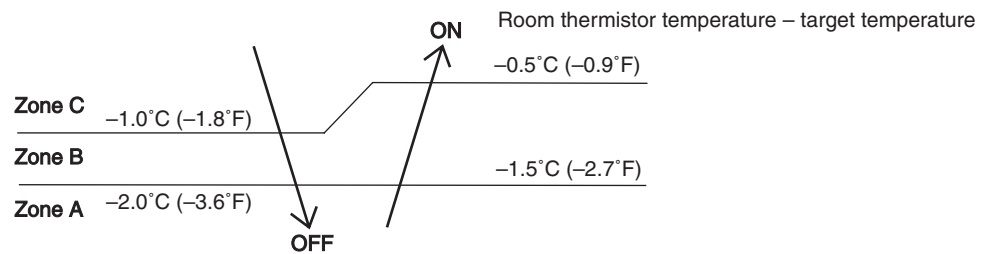

(R24628)

Heating

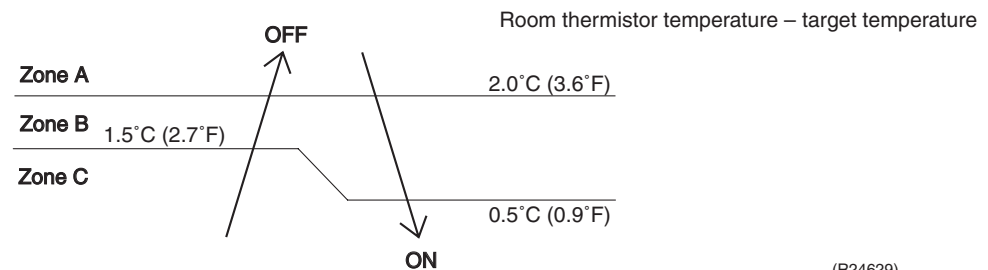

(R24629)



Refer to Temperature Control on page 13 for details.

1.8 NIGHT SET Mode

Outline When the OFF TIMER is set, NIGHT SET Mode is automatically activated. NIGHT SET Mode keeps the airflow rate setting.

Details NIGHT SET Mode continues operation at the target temperature for the first one hour, then automatically raises the target temperature slightly in the case of cooling, or lowers it slightly in the case of heating. This prevents excessive cooling in summer and excessive heating in winter to ensure comfortable sleeping conditions, and also conserves electricity.

Cooling

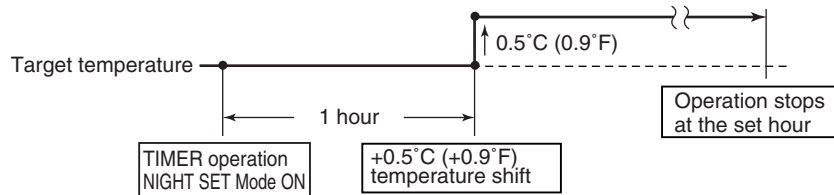

(R23917)

Heating

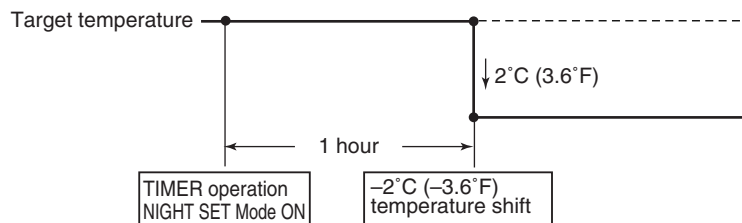

(R23918)

1.9 ECONO Operation

Outline ECONO operation reduces the maximum power consumption. This operation is particularly convenient for energy-saving. It is also a major bonus when breaker capacity does not allow the use of multiple electrical devices and air conditioners. It can be easily activated by pressing **ECONO** button on the wireless remote controller.

Details

- When this function is activated, the maximum capacity also decreases.
- The remote controller can send the ECONO command when the unit is in cooling, heating, dry, or automatic operation. This function can only be set when the unit is running. Press **ON/OFF** button on the remote controller to cancel the function.
- This function and POWERFUL operation cannot be used at the same time. The latest command has the priority.

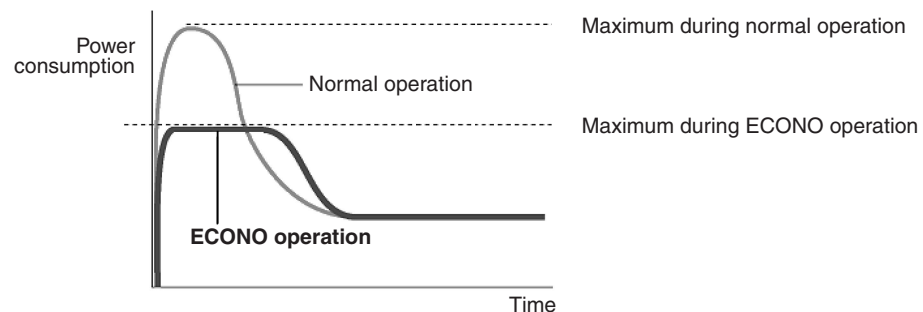

(R21051)

1.10 INTELLIGENT EYE Operation

Outline

This function detects the presence of humans in the room with a motion sensor and reduces the capacity when there is nobody in the room in order to save electricity.

Details

1. INTELLIGENT EYE detection method

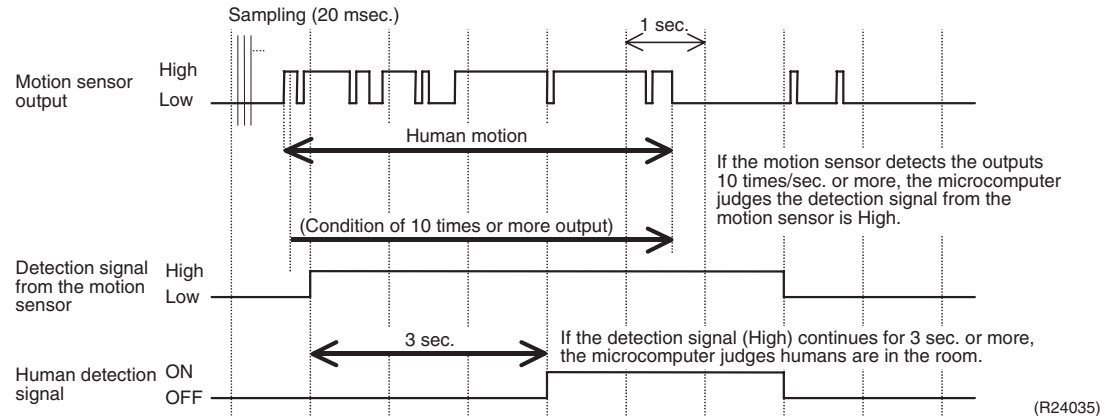

- The motion sensor detects human motion by receiving infrared rays and sends the pulse wave output.
- The microcomputer in the indoor unit carries out a sampling every 20 msec. If the motion sensor detects 10 times or more of the wave output in one second in total, and the High signal continues for 3 sec., the microcomputer judges humans are in the room as the human detection signal is ON.

2. Motions (in cooling)

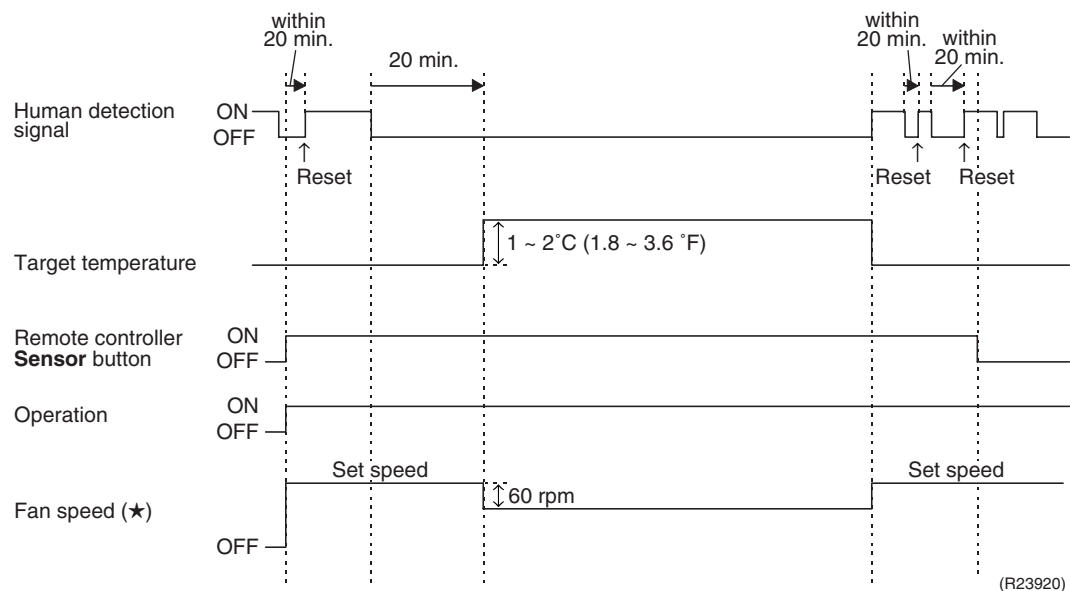

- ★ In FAN operation, the fan speed is reduced by 60 rpm when no one is in the area.
- When there is no signal from the motion sensor in 20 minutes, the microcomputer judges that nobody is in the room and operates the unit at a temperature shifted from the target temperature. (Cooling/Dry: 1 ~ 2°C (1.8 ~ 3.6°F) higher, Heating: 2°C (3.6°F) lower, Auto: according to the operation mode at that time.)



Note: For dry operation, the target temperature is shifted internally. The temperature cannot be set with the remote controller.

1.11 POWERFUL Operation

Outline

In order to exploit the cooling and heating capacity to full extent, the air conditioner can be operated by increasing the indoor fan rotating speed and the compressor frequency.

Details

When **POWERFUL** button is pressed, the fan speed and target temperature are converted to the following states for 20 minutes.

Operation mode	Fan speed	Target temperature
COOL	H tap + A rpm	18°C (64.4°F)
DRY	Dry rotating speed + A rpm	Lowered by 2.5°C (4.5°F)
HEAT	H tap + A rpm	31.5°C (88.7°F)
FAN	H tap + A rpm	—
AUTO	Same as cooling/heating in POWERFUL operation	The target temperature is kept unchanged.

A = 0 ~ 50 rpm (depending on the operating mode)

Ex: POWERFUL operation in cooling

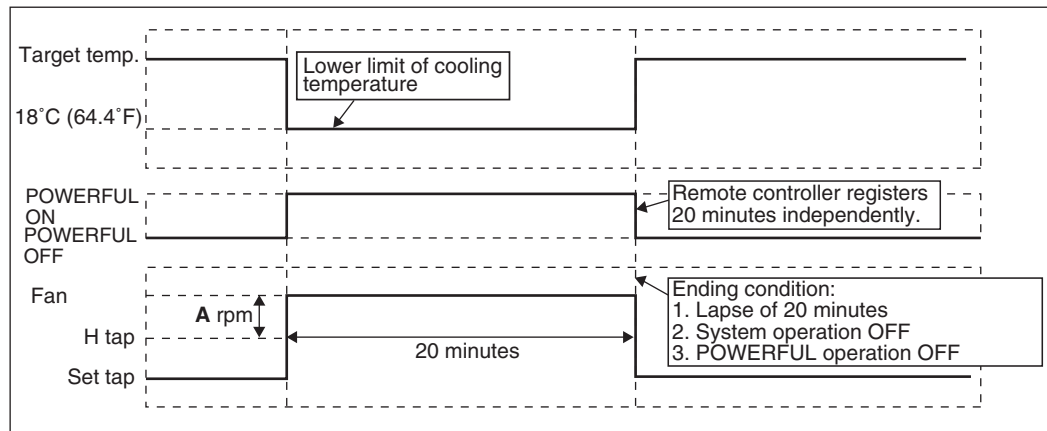

(R24528)



Note: POWERFUL operation cannot be used together with ECONO, COMFORT AIRFLOW or OUTDOOR UNIT QUIET operation.

1.12 Clock Setting

ARC466 Series

The clock can be set by taking the following steps:

1. Press **Clock** button.
→ 0:00 is displayed and **MON** and ☰ blink.
2. Press **Select ▲** or **Select ▼** button to set the clock to the current day of the week.
3. Press **Clock** button.
→ ☰ blinks.
4. Press **Select ▲** or **Select ▼** button to set the clock to the present time.
Holding down **Select ▲** or **Select ▼** button rapidly increases or decreases the displayed time.
5. Press **Clock** button. (Point the remote controller at the indoor unit when pressing the button.)
→ : blinks and clock setting is completed.

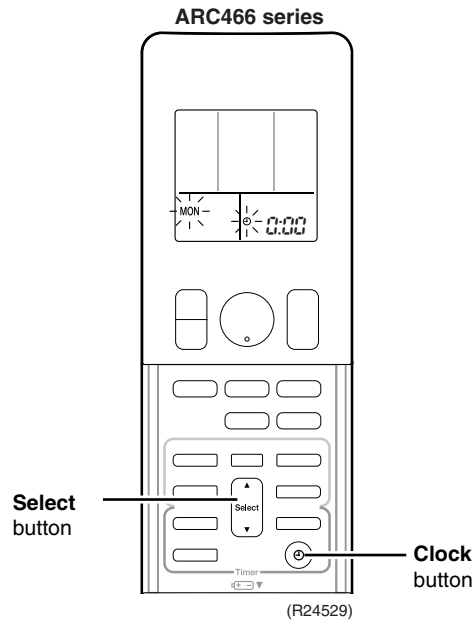

1.13 WEEKLY TIMER Operation

Outline

Up to 4 timer settings can be saved for each day of the week (up to 28 settings in total). The 3 items: ON/OFF, temperature, and time can be set.

Details

Setting example of the WEEKLY TIMER

The same timer settings are used from Monday through Friday, while different timer settings are used for the weekend.

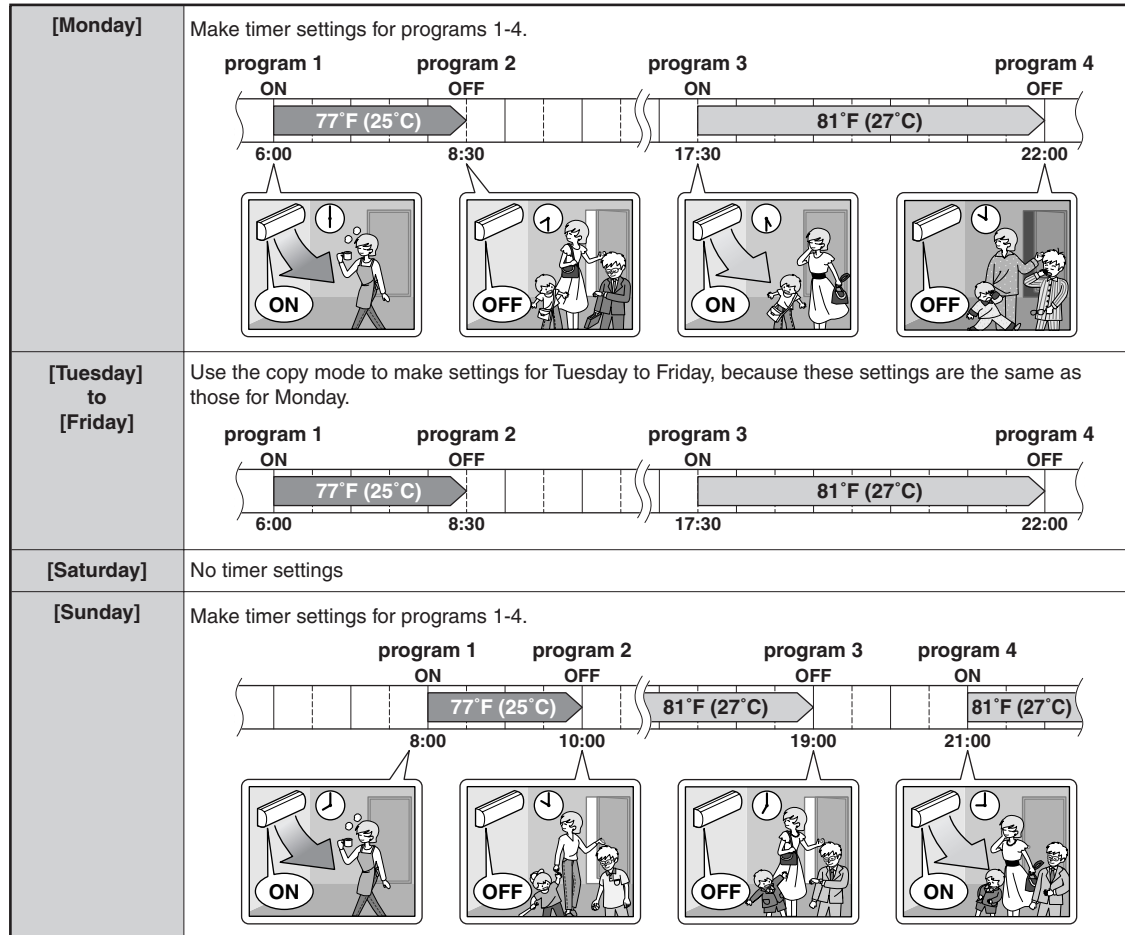

- Up to 4 reservations per day and 28 reservations per week can be set using the WEEKLY TIMER. The effective use of the copy mode simplifies timer programming.
- The use of ON-ON-ON-ON settings, for example, makes it possible to schedule operating mode and set temperature changes. Furthermore, by using OFF-OFF-OFF-OFF settings, only the turn off time of each day can be set. This will turn off the air conditioner automatically if you forget to turn it off.

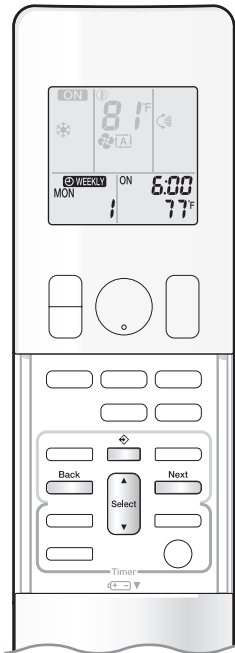

To use WEEKLY TIMER operation

Setting mode

- Make sure the day of the week and time are set.
If not, set the day of the week and time.

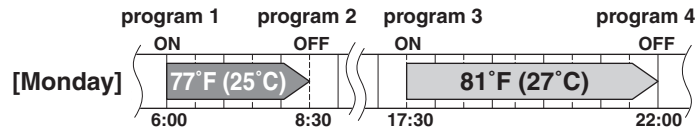

Setting Displays

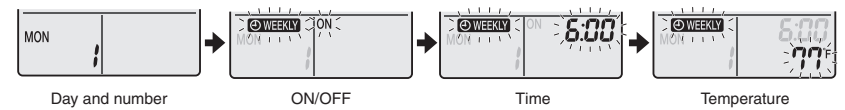

1. Press .

- The day of the week and the reservation number of the current day will be displayed.
- 1 to 4 settings can be made per day.

2. Press to select the desired day of the week and reservation number.

- Pressing changes the reservation number and the day of the week.

3. Press .

- The day of the week and reservation number will be set.
- “ WEEKLY” and “ON” blink.

4. Press to select the desired mode.

- Pressing changes the “ON” or “OFF” setting in sequence.



- In case the reservation has already been set, selecting “blank” deletes the reservation.
- Proceed to **STEP 9** if “blank” is selected.
- To return to the day of the week and reservation number setting, press .

5. Press .

- The ON/OFF TIMER mode will be set.
- “ WEEKLY” and the time blink.

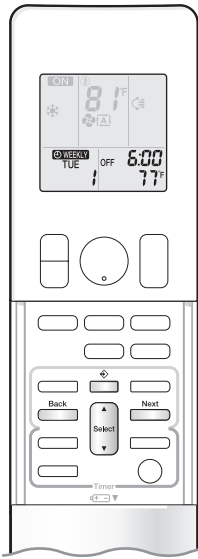

6. Press to select the desired time.

- The time can be set between 0:00 and 23:50 in 10-minute intervals.
- To return to the ON/OFF TIMER mode setting, press .
- Proceed to **STEP 9** when setting the OFF TIMER.

7. Press .

- The time will be set.
- “ WEEKLY” and the temperature blink.

8. Press to select the desired temperature.

- The temperature can be set between 50°F (10°C) and 90°F (32°C).
COOL or AUTO: The unit operates at 64°F (18°C) even if it is set at 50°F (10°C) to 63°F (17°C).
HEAT or AUTO : The unit operates at 86°F (30°C) even if it is set at 87°F (31°C) to 90°F (32°C).
- To return to the time setting, press .
- The set temperature is only displayed when the mode setting is on.

9. Press .

- Check for a receiving tone and that the OPERATION lamp blinks twice.
- The TIMER lamp lights orange.
- Temperature and time are set in the case of ON TIMER operation, and the time is set in the case of OFF TIMER operation.
- The next reservation screen will appear.
- To continue further settings, repeat the procedure from **STEP 4**.





Display

10. Press to complete the setting.

- “ WEEKLY” is displayed on the LCD and WEEKLY TIMER operation is activated.
- A reservation made once can be easily copied and the same settings used for another day of the week. Refer to **Copy mode**.

NOTE

Notes on WEEKLY TIMER operation

- Do not forget to set the clock on the remote controller first.
- The day of the week, ON/OFF TIMER mode, time and set temperature (only for ON TIMER mode) can be set with the WEEKLY TIMER. When set to ON TIMER mode, operation will begin in the settings used previously for operation mode, temperature, airflow rate, and airflow direction.
- WEEKLY TIMER and ON/OFF TIMER operation cannot be used at the same time. The ON/OFF TIMER operation has priority if it is set while WEEKLY TIMER is still active. The WEEKLY TIMER will enter the standby state, and “ WEEKLY” will disappear from the LCD. When the ON/OFF TIMER is up, the WEEKLY TIMER will automatically become active.
- Turning off the circuit breaker, power failure, and other similar events will render operation of the indoor unit's internal clock inaccurate. Reset the clock.
-  can be used only for the time and temperature settings. It cannot be used to go back to the reservation number.

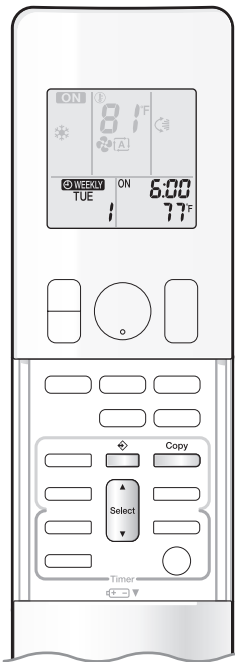

Copy mode

- A reservation made once can be copied to another day of the week. The whole reservation of the selected day of the week will be copied.

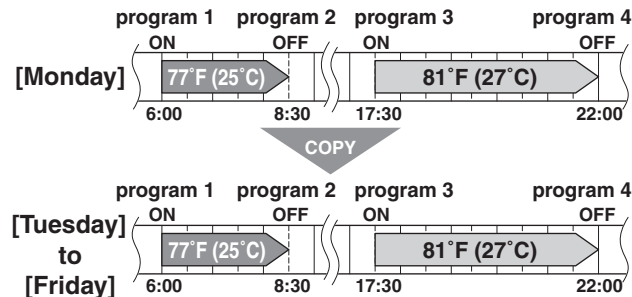

Setting Displays

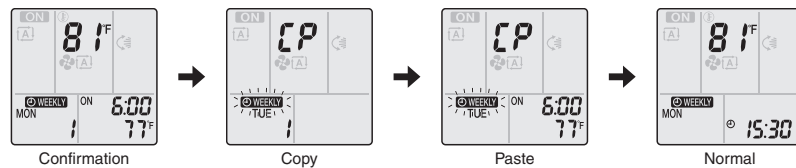

1. Press .

2. Press  to confirm the day of the week to be copied.

3. Press .

- The whole reservation of the selected day of the week will be copied.

4. Press  to select the destination day of the week.

5. Press .

- Check for a receiving tone and that the OPERATION lamp blinks twice.
- The reservation will be copied to the selected day of the week. The whole reservation of the selected day of the week will be copied.
- To continue copying the settings to other days of the week, repeat **STEP 4** and **STEP 5**.

6. Press  to complete the setting.

- “ WEEKLY” is displayed on the LCD and WEEKLY TIMER operation is activated.

NOTE

Note on COPY MODE

- The entire reservation of the source day of the week is copied in the copy mode.
In the case of making a reservation change for any day of the week individually after copying the content of weekly reservations, press  and change the settings in the steps of **Setting mode**.

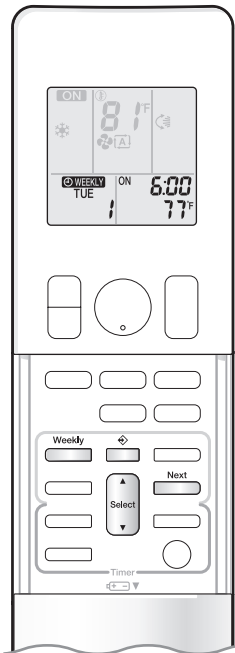

Confirming a reservation

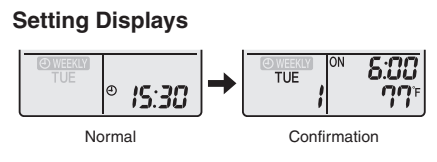

- The reservation can be confirmed.



1. Press .

- The day of the week and the reservation number of the current day will be displayed.

2. Press to select the day of the week and the reservation number to be confirmed.



- Pressing  displays the reservation details.
- To change the confirmed reserved settings, select the reservation number and press . The mode is switched to setting mode. Proceed to **Setting mode STEP 4**.

3. Press to exit the confirmation mode.

- “” is displayed on the LCD and WEEKLY TIMER operation is activated.

To deactivate WEEKLY TIMER operation

Press while “” is displayed on the LCD.

- “” disappears from the LCD.
- The TIMER lamp goes off.
- To reactivate the WEEKLY TIMER operation, press  again.
- If a reservation deactivated with  is activated once again, the last reservation mode will be used.

NOTE

- If not all the reservation settings are reflected, deactivate the WEEKLY TIMER operation once. Then press  again to reactivate the WEEKLY TIMER operation.

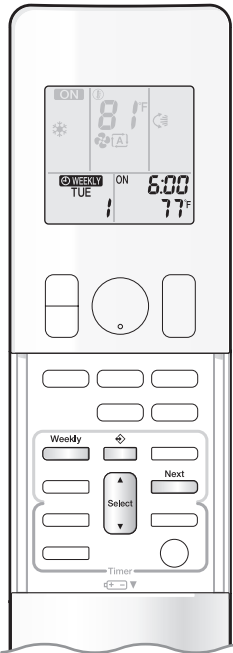

To delete reservations

An individual reservation

1. Press .

- The day of the week and the reservation number will be displayed.

2. Press to select the day of the week and the reservation number to be deleted.

3. Press .

- “ WEEKLY” and “ON” or “OFF” blink.

4. Press until no icon is displayed.

- Pressing  changes the ON/OFF TIMER mode in sequence.
- Selecting “blank” will cancel any reservation you may have.



5. Press .

- The selected reservation will be deleted.
- Check for a receiving tone and that the OPERATION lamp blinks twice.

6. Press .

- If there are still other reservations, WEEKLY TIMER operation will be activated.

Reservations for each day of the week

- This function can be used for deleting reservations for each day of the week.
- It can be used while confirming or setting reservations.

1. Press .

- The day of the week and the reservation number will be displayed.

2. Press to select the day of the week to be deleted.

3. Hold for about 5 seconds.

- Check for a receiving tone and that the OPERATION lamp blinks twice.
- The reservation of the selected day of the week will be deleted.

4. Press .

- If there are still other reservations, WEEKLY TIMER operation will be activated.

All reservations

Hold for about 5 seconds with the normal display.

- Check for a receiving tone and that the OPERATION lamp blinks twice.
- “ WEEKLY” disappears from the LCD.
- The TIMER lamp goes off.
- All reservations will be deleted.
- This operation is not functional while the WEEKLY TIMER setting screen is displayed.

1.14 Other Functions

1.14.1 Hot-Start Function

In order to prevent the cold air blast that normally occurs when heating operation starts, the temperature of the indoor heat exchanger is detected, and the airflow is either stopped or significantly weakened resulting in comfortable heating.



Note: The cold air blast is prevented using similar control when defrost control starts or when the thermostat is turned ON.

1.14.2 Signal Receiving Sign

When the indoor unit receives a signal from the remote controller, the unit emits a signal receiving sound and the operation lamp blinks.

1.14.3 Indoor Unit ON/OFF Button

ON/OFF button is provided on the display of the unit.

- Press **ON/OFF** button once to start operation. Press once again to stop it.
- **ON/OFF** button is useful when the remote controller is missing or the battery has run out.

	Mode	Temperature setting	Airflow rate
Cooling Only	COOL	22°C (72°F)	Automatic
Heat Pump	AUTO	25°C (77°F)	Automatic

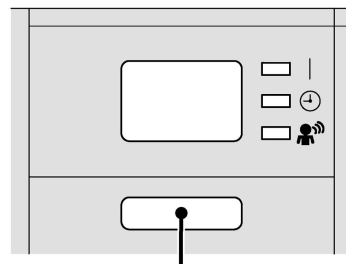

ON/OFF button (R20396)

Forced cooling operation

Forced cooling operation can be started by pressing **ON/OFF** button for 5 to 9 seconds while the unit is not operating. Forced cooling operation is not started if **ON/OFF** button is pressed for 10 seconds or more.

Refer to page 105 for details.

1.14.4 Auto-restart Function

If a power failure (even a momentary one) occurs during the operation, the system restarts automatically in the same conditions as before when the power supply is restored to the conditions prior to the power failure.



Note: It takes 3 minutes to restart the operation because the 3-minute standby function is activated.

2. Thermistor Functions

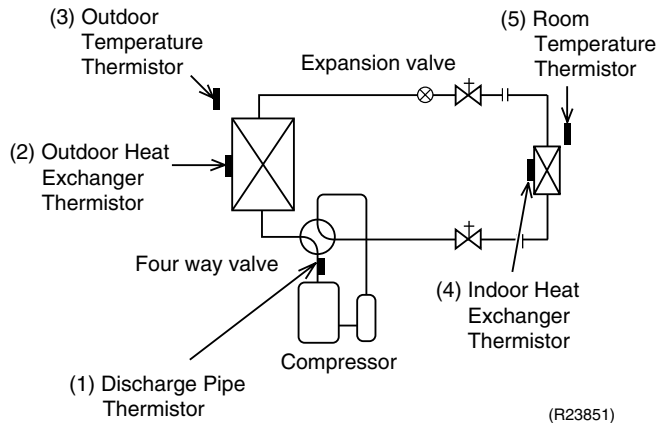

(1) Discharge Pipe Thermistor

- The discharge pipe thermistor is used for controlling discharge pipe temperature. If the discharge pipe temperature (used in place of the inner temperature of the compressor) rises abnormally, the operating frequency becomes lower or the operation halts.
- The discharge pipe thermistor is used for detecting disconnection of the discharge pipe thermistor.

(2) Outdoor Heat Exchanger Thermistor

- The outdoor heat exchanger thermistor is used for controlling the target discharge pipe temperature. The system sets the target discharge pipe temperature according to the outdoor and indoor heat exchanger temperature, and controls the electronic expansion valve opening so that the target discharge pipe temperature can be obtained.
- In cooling operation, the outdoor heat exchanger thermistor is used for detecting the disconnection of the discharge pipe thermistor. When the discharge pipe temperature drops below the outdoor heat exchanger temperature by more than a certain value, the discharge pipe thermistor is judged as disconnected.
- In cooling operation, the outdoor heat exchanger thermistor is used for high pressure protection.

(3) Outdoor Temperature Thermistor

- The outdoor temperature thermistor detects the outdoor air temperature and is used for refrigerant shortage detection, input current control, outdoor fan control, liquid compression protection function, and so on.

(4) Indoor Heat Exchanger Thermistor

- The indoor heat exchanger thermistor is used for controlling the target discharge pipe temperature. The system sets the target discharge pipe temperature according to the outdoor and indoor heat exchanger temperature, and controls the electronic expansion valve opening so that the target discharge pipe temperature can be obtained.
- In cooling operation, the indoor heat exchanger thermistor is used for freeze-up protection control. If the indoor heat exchanger temperature drops abnormally, the operating frequency becomes lower or the operation halts.
- In cooling operation, the indoor heat exchanger thermistor is used for anti-icing function. If any of the following conditions are met in the room where operation halts, it is assumed as icing.

The conditions are

$$T_c \leq -1^\circ \text{C}$$

$$T_a - T_c \geq 10^\circ \text{C}$$

where T_a is the room temperature and T_c is the indoor heat exchanger temperature.

- In heating operation, the indoor heat exchanger thermistor is used for heating peak-cut control. If the indoor heat exchanger temperature rises abnormally, the operating frequency becomes lower or the operation halts.
- In heating operation, the indoor heat exchanger thermistor is used for detecting the disconnection of the discharge pipe thermistor. When the discharge pipe temperature drops below the highest indoor heat exchanger temperature by more than a certain value, the discharge pipe thermistor is judged as disconnected.
- When only one indoor unit is operating, the indoor heat exchanger thermistor is used for subcooling control. The actual subcool is calculated with the liquid pipe temperature and the indoor heat exchanger temperature. The system controls the electronic expansion valve openings to obtain the target subcool.

(5) Room Temperature Thermistor

- The room temperature thermistor detects the room air temperature and is used for controlling the room air temperature.

3. Control Specification

3.1 Mode Hierarchy

Outline The air conditioner control has normal operation mode, forced operation mode, and power transistor test mode for installation and servicing.

Details

Cooling Only Model

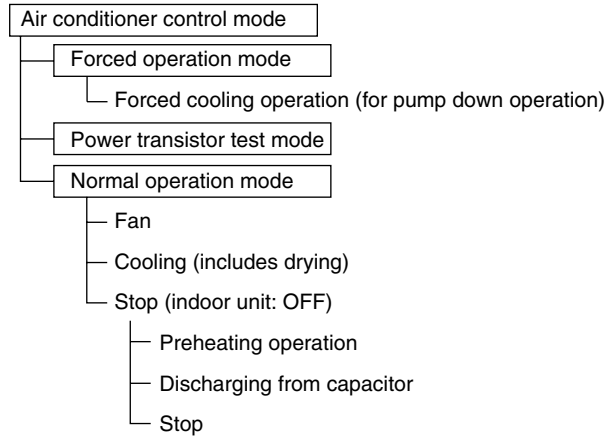

(R19505)

Heat Pump Model

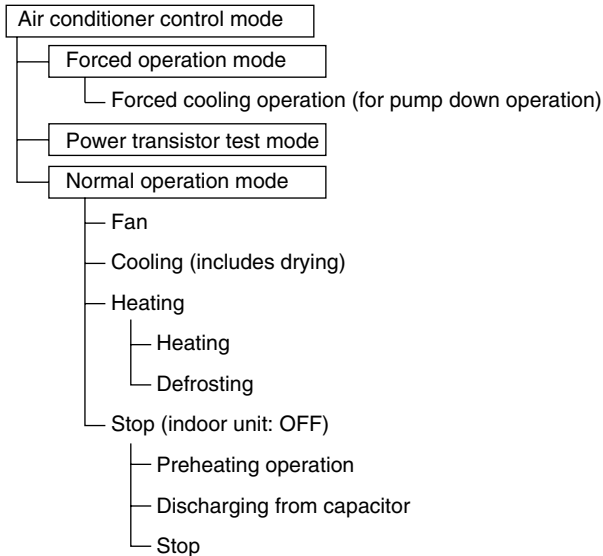

(R19522)



Note: Unless specified otherwise, dry operation command is regarded as cooling operation.

3.2 Frequency Control

Outline

The compressor frequency is determined according to the difference between the room thermistor temperature and the target temperature.

When the shift of the frequency is less than zero ($\Delta F < 0$) by PI control, the target frequency is used as the command frequency.

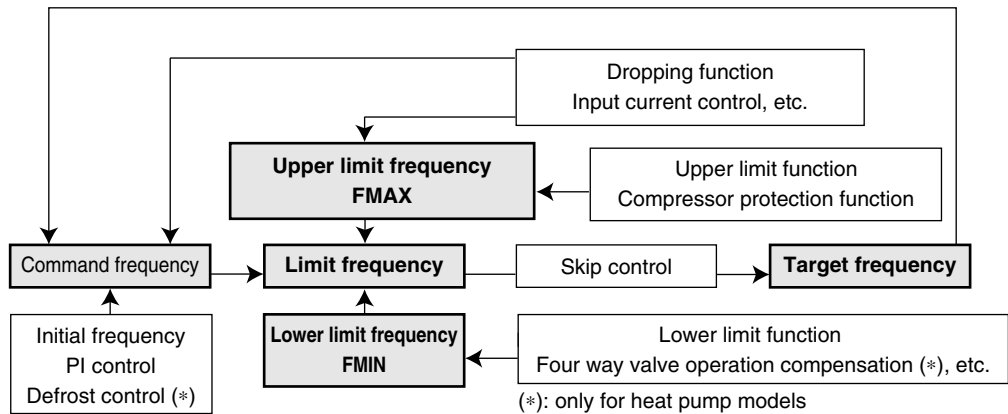

(R17857)

Details

For Cooling Only Model

1. Determine command frequency

Command frequency is determined in the following order of priority.

1. Forced cooling
2. Indoor frequency command

2. Determine upper limit frequency

The minimum value is set as an upper limit frequency among the frequency upper limits of the following functions:

Compressor protection, input current, discharge pipe temperature, freeze-up protection.

3. Determine lower limit frequency

The maximum value is set as a lower limit frequency among the frequency lower limits of the following function:

Pressure difference upkeep.

4. Determine prohibited frequency

There is a certain prohibited frequency such as a power supply frequency.

For Heat Pump Model

1. Determine command frequency

Command frequency is determined in the following order of priority.

1. Limiting defrost control time
2. Forced cooling
3. Indoor frequency command

2. Determine upper limit frequency

The minimum value is set as an upper limit frequency among the frequency upper limits of the following functions:

Compressor protection, input current, discharge pipe temperature, heating peak-cut, freeze-up protection, defrost control.

3. Determine lower limit frequency

The maximum value is set as a lower limit frequency among the frequency lower limits of the following functions:

Four way valve operation compensation, draft prevention, pressure difference upkeep.

4. Determine prohibited frequency

There is a certain prohibited frequency such as a power supply frequency.

Initial Frequency

When starting the compressor, the frequency is initialized according to the ΔD value of the indoor unit.

 ΔD signal: Indoor frequency command

The difference between the room thermistor temperature and the target temperature is taken as the ΔD value and is used for ΔD signal of frequency command.

Temperature difference	ΔD signal	Temperature difference	ΔD signal	Temperature difference	ΔD signal
-2.0°C (-3.6°F)	*OFF	0°C (0°F)	4	2.0°C (3.6°F)	8
-1.5°C (-2.7°F)	1	0.5°C (0.9°F)	5	2.5°C (4.5°F)	9
-1.0°C (-1.8°F)	2	1.0°C (1.8°F)	6	3.0°C (5.4°F)	10★
-0.5°C (-0.9°F)	3	1.5°C (2.7°F)	7	3.5°C (6.3°F)	11★

*OFF = Thermostat OFF

★ For heating operation only.

PI Control**1. P control**

The ΔD value is calculated in each sampling time (20 seconds), and the frequency is adjusted according to its difference from the frequency previously calculated.

2. I control

If the operating frequency does not change for more than a certain fixed time, the frequency is adjusted according to the ΔD value.

When ΔD value is low, the frequency is lowered.

When ΔD value is high, the frequency is increased.

3. Frequency control when other controls are functioning

- ◆ When frequency is dropping:
Frequency control is carried out only when the frequency drops.
- ◆ For limiting lower limit:
Frequency control is carried out only when the frequency rises.

4. Upper and lower limit of frequency by PI control

The frequency upper and lower limits are set according to the command of the indoor unit.

When the indoor or outdoor unit quiet operation command comes from the indoor unit, the upper limit frequency is lower than the usual setting.

3.3 Controls at Mode Changing/Start-up

3.3.1 Preheating Operation

Outline The inverter operation in open phase starts with the conditions of the outdoor temperature and the preheating command from the indoor unit.

Details

ON Condition

- When the outdoor temperature is below 6°C (42.8°F), the inverter operation in open phase starts.

OFF Condition

- When the outdoor temperature is higher than 8°C (46.4°F), the inverter operation in open phase stops.

3.3.2 Four Way Valve Switching

Outline The four way valve coil is energized/not energized depending on the operation mode. (Heating: ON, Cooling/Dry/Defrost: OFF)
In order to eliminate the switching sound as the four way valve coil switches from ON to OFF when the heating is stopped, the OFF delay switch of the four way valve is carried out.

Details

OFF delay switch of four way valve

The four way valve coil is energized for 160 seconds after the operation is stopped.

3.3.3 Four Way Valve Operation Compensation

Outline At the beginning of operation as the four way valve is switched, the pressure difference to activate the four way valve is acquired when the output frequency is higher than a certain fixed frequency, for a certain fixed time.

Details

Starting Conditions

- Compressor starts and the four way valve switches from OFF to ON
- Four way valve switches from ON to OFF during operation
- Compressor starts after resetting
- Compressor starts after the fault of four way valve switching

The lower limit of frequency keeps **A** Hz for **B** seconds with any conditions 1 through 4 above.

When the outdoor temperature is above **C** in heating, the frequency decreases depending on the outdoor temperature.

	RK30/36NMVJU		RX30/36NMVJU	
	Cooling	Heating	Cooling	Heating
A (Hz)	46	—	46	52
B (seconds)	60		60	
C	(°C)	15	15	
	(°F)	59	59	

3.3.4 3-Minute Standby

Turning on the compressor is prohibited for 3 minutes after turning it off.
(The function is not activated when defrosting.)

3.3.5 Compressor Protection Function

When turning the compressor from OFF to ON, the upper limit of frequency is set as follows.
(The function is not activated when defrosting.)

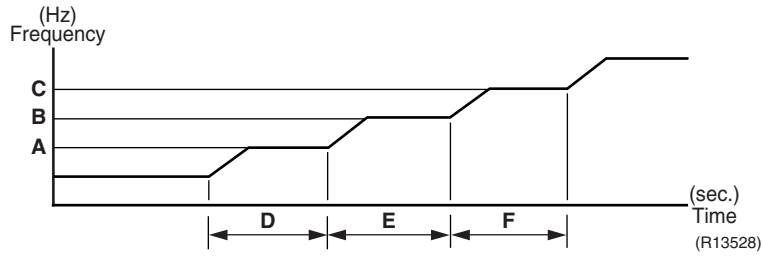

	RK30/36NMVJU		RX30/36NMVJU	
	Cooling	Heating	Cooling	Heating
A (Hz)	28	—	28	30
B (Hz)	42	—	42	78
C (Hz)	56	—	56	118
D (seconds)	180	—	180	1080
E (seconds)	180	—	180	90
F (seconds)	180	—	180	240

3.4 Discharge Pipe Temperature Control

Outline

The discharge pipe temperature is used as the internal temperature of the compressor. If the discharge pipe temperature rises above a certain level, the upper limit of frequency is set to keep the discharge pipe temperature from rising further.

Details

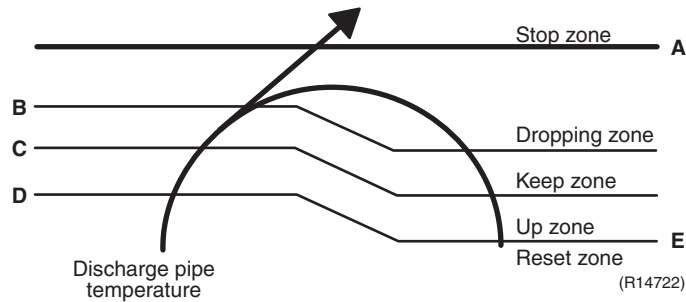

	RK(X)30/36NMVJU	
	(°C)	(°F)
A	120	248.0
B	111	231.8
C	109	228.2
D	107	224.6
E	107	224.6

Zone	Control
Stop zone	When the temperature reaches the stop zone, the compressor stops.
Dropping zone	The upper limit of frequency decreases.
Keep zone	The upper limit of frequency is kept.
Up zone	The upper limit of frequency increases.
Reset zone	The upper limit of frequency is canceled.

3.5 Input Current Control

Outline

The microcomputer calculates the input current while the compressor is running, and sets the frequency upper limit based on the input current.

In case of heat pump models, this control is the upper limit control of frequency and takes priority over the lower limit control of four way valve operation compensation.

Details

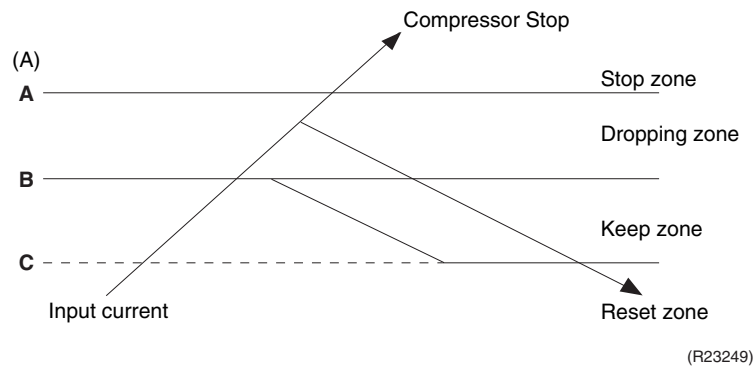

Frequency control in each zone

Stop zone

- After the input current remains in the stop zone for 2.5 seconds, the compressor is stopped.

Dropping zone

- The upper limit of the compressor frequency is defined as operation frequency – 2 Hz.
- After this, the output frequency is lowered by 2 Hz every second until it reaches the keep zone.

Keep zone

- The present maximum frequency goes on.

Reset zone

- Limit of the frequency is canceled.

	RK30/36NMVJU		RX30/36NMVJU	
	Cooling	Heating	Cooling	Heating
A (A)	20		20	
B (A)	16.25	—	16.25	18.25
C (A)	15.25	—	15.25	17.25

Limitation of current dropping and stop value according to the outdoor temperature

- The current drops when outdoor temperature becomes higher than a certain level (depending on the model).

3.6 Freeze-up Protection Control

During cooling operation, the signal sent from the indoor unit determines the frequency upper limit and prevents freezing of the indoor heat exchanger. (The signal from the indoor unit is divided into zones.)

The operating frequency limitation is judged with the indoor heat exchanger temperature.

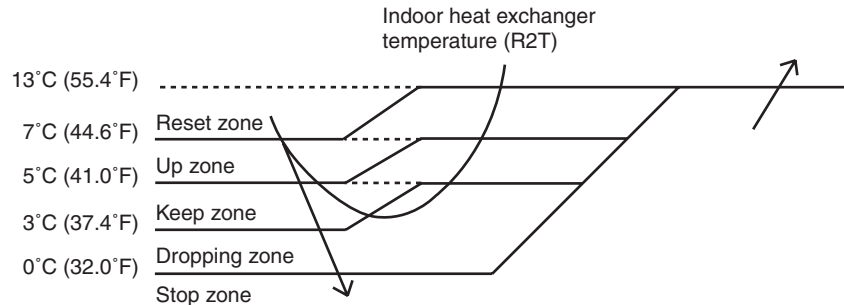

(R24574)

3.7 Heating Peak-cut Control

During heating operation, the indoor heat exchanger temperature determines the frequency upper limit to prevent abnormal high pressure.

The operating frequency limitation is judged with the indoor heat exchanger temperature.

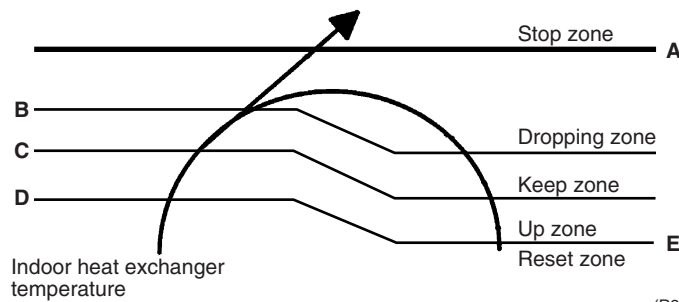

(R23928)

	RX30/36NMVJU	
	(°C)	(°F)
A	60	140.0
B	57	134.6
C	54	129.2
D	52	125.6
E	47	116.6

Zone	Control
Stop zone	When the temperature reaches the stop zone, the compressor stops.
Dropping zone	The upper limit of frequency decreases.
Keep zone	The upper limit of frequency is kept.
Up zone	The upper limit of frequency increases.
Reset zone	The upper limit of frequency is canceled.

3.8 Outdoor Fan Control

1. Fan ON control to cool down the electrical box

The outdoor fan is turned ON when the electrical box temperature is high while the compressor is OFF.

2. Fan OFF control during defrosting

The outdoor fan is turned OFF during defrosting.

3. Fan OFF delay when stopped

The outdoor fan is turned OFF 60 seconds after the compressor stops.

4. Fan speed control for pressure difference upkeep

The rotation speed of the outdoor fan is controlled for keeping the pressure difference during cooling operation with low outdoor temperature.

- ◆ When the pressure difference is low, the rotation speed of the outdoor fan is reduced.
- ◆ When the pressure difference is high, the rotation speed of the outdoor fan is controlled as well as normal operation.

5. Fan speed control during forced cooling operation

The outdoor fan is controlled as well as normal operation during forced cooling operation.

6. Fan speed control during POWERFUL operation

The rotation speed of the outdoor fan is increased during POWERFUL operation.

7. Fan speed control during indoor/outdoor unit quiet operation

The rotation speed of the outdoor fan is reduced by the command of the indoor/outdoor unit quiet operation.

8. Fan ON/OFF control when operation (cooling, heating, dry) starts/stops

The outdoor fan is turned ON when the operation starts. The outdoor fan is turned OFF when the operation stops.

3.9 Liquid Compression Protection Function

Outline

In order to increase the dependability of the compressor, the compressor is stopped according to the outdoor temperature.

Details

Operation stops depending on the outdoor temperature

Compressor turns off under the conditions that the system is in cooling operation and outdoor temperature is below 0°C (32°F).

3.10 Defrost Control

Outline

Defrosting is carried out by the cooling cycle (reverse cycle). The defrosting time or outdoor heat exchanger temperature must be more than a certain value to finish defrosting.

Details

Conditions for Starting Defrost

- The starting conditions are determined with the outdoor temperature and the outdoor heat exchanger temperature.
- The system is in heating operation.
- The compressor operates for 6 minutes.
- More than **A** minutes (depending on the duration of the previous defrost control) of accumulated time have passed since the start of the operation, or ending the previous defrosting.

Conditions for Canceling Defrost

The judgment is made with the outdoor heat exchanger temperature (**B**).

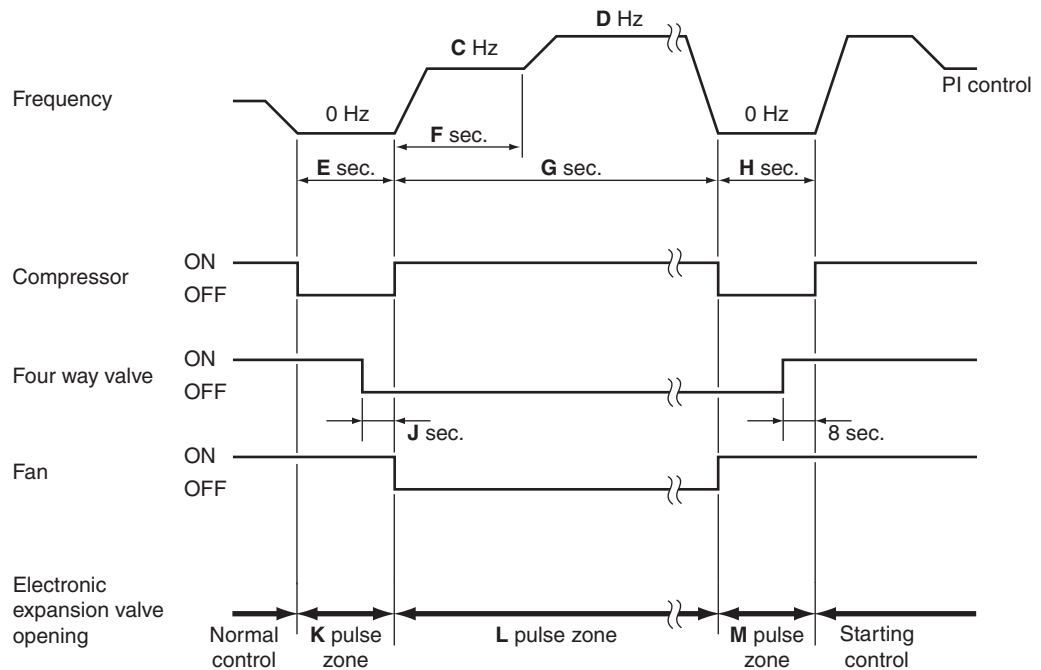

(R21661)

		RX30/36NMVJU
A	(minute)	15 ~ 25
B	(°C)	6 ~ 30
	(°F)	42.8 ~ 86.0
C	(Hz)	58
D	(Hz)	58
E	(seconds)	60
F	(seconds)	60
G	(seconds)	340
H	(seconds)	60
J	(seconds)	8
K	(pulse)	200
L	(pulse)	150
M	(pulse)	200

3.11 Electronic Expansion Valve Control

Outline

The following items are included in the electronic expansion valve control.

Electronic expansion valve is fully closed

1. Electronic expansion valve is fully closed when turning on the power.
2. Pressure equalizing control

Open Control

1. Electronic expansion valve control when starting operation
2. Electronic expansion valve control when the frequency changes
3. Electronic expansion valve control for defrosting
4. Electronic expansion valve control when the discharge pipe temperature is abnormally high
5. Electronic expansion valve control when the discharge pipe thermistor is disconnected

Feedback Control

Target discharge pipe temperature control

Details

The following are examples of electronic expansion valve control for each operation mode.

Control	Status							
	Power on : Compressor stop	Operation start	Frequency change under starting control	During target discharge pipe temperature control	Frequency change under target discharge pipe temperature control	Discharge pipe thermistor disconnection	Frequency change under discharge pipe thermistor disconnection control	During defrost control
Starting operation control	—	●	—	—	—	—	—	—
Control when the frequency changes	—	—	●	—	●	—	—	—
Target discharge pipe temperature control	—	—	—	●	—	—	—	—
Discharge pipe thermistor disconnection control	—	—	—	—	—	●	●	—
High discharge pipe temperature control	—	●	●	●	●	—	—	—
Defrost control (heating only)	—	—	—	—	—	—	—	●
Pressure equalizing control	●	—	—	—	—	—	—	—
Opening limit control	—	●	●	●	●	●	●	—

- : Available
- : Not available

3.11.1 Initialization as Power Supply On

The electronic expansion valve is initialized (fully closed) when the power is turned on. Then, the valve opening is set and the pressure is equalized.

3.11.2 Pressure Equalizing Control

When the compressor is stopped, the pressure equalizing control is activated. The electronic expansion valve opens and the pressure is equalized.

3.11.3 Opening Limit Control

The maximum and minimum opening of the electronic expansion valve are limited.

	RK(X)30/36NMVJU
Maximum opening (pulse)	480
Minimum opening (pulse)	56

The electronic expansion valve is fully closed when cooling operation stops, and is opened at a fixed degree during defrosting.

3.11.4 Starting Operation Control

The electronic expansion valve opening is controlled when the operation starts, thus preventing superheating or liquid compression.

3.11.5 Control when the frequency changes

When the target discharge pipe temperature control is active, if the target frequency changes to a specified value in a certain period of time, the target discharge pipe temperature control is canceled and the target opening of the electronic expansion valve is changed according to the frequency shift.

3.11.6 High Discharge Pipe Temperature Control

When the compressor is operating, if the discharge pipe temperature exceeds a certain value, the electronic expansion valve opens and the refrigerant runs to the low pressure side. This procedure lowers the discharge pipe temperature.

3.11.7 Discharge Pipe Thermistor Disconnection Control

Outline

The disconnection of the discharge pipe thermistor is detected by comparing the discharge pipe temperature with the condensation temperature. If the discharge pipe thermistor is disconnected, the electronic expansion valve opens according to the outdoor temperature and the operation frequency, operates for a specified time, and then stops.

After 3 minutes, the operation restarts and checks if the discharge pipe thermistor is disconnected. If the discharge pipe thermistor is disconnected, the system stops after operating for a specified time.

If the disconnection is detected repeatedly, the system is shut down. When the compressor runs for 60 minutes without any error, the error counter is reset.

Details

Determining thermistor disconnection

When the starting control (Cooling: **A** seconds, Heating: **B** seconds) finishes, the detection timer for disconnection of the discharge pipe thermistor (**C** seconds) starts. When the timer is over, the following adjustment is made.

1. When the operation mode is cooling

When the following condition is fulfilled, the discharge pipe thermistor disconnection is ascertained.

Discharge pipe temperature $+6^{\circ}\text{C}$ ($+10.8^{\circ}\text{F}$) $<$ outdoor heat exchanger temperature

2. When the operation mode is heating

When the following condition is fulfilled, the discharge pipe thermistor disconnection is ascertained.

Discharge pipe temperature $+6^{\circ}\text{C}$ ($+10.8^{\circ}\text{F}$) $<$ indoor heat exchanger temperature

	RK(X)30/36NMVJU
A (seconds)	180
B (seconds)	60
C (seconds)	1020

When the thermistor is disconnected

When the disconnection is ascertained, the compressor continues operation for 9 minutes and then stops.

If the compressor stops repeatedly, the system is shut down.

3.11.8 Target Discharge Pipe Temperature Control

The target discharge pipe temperature is obtained from the indoor and outdoor heat exchanger temperature, and the electronic expansion valve opening is adjusted so that the actual discharge pipe temperature becomes close to the target discharge pipe temperature. (Indirect SH (superheating) control using the discharge pipe temperature)

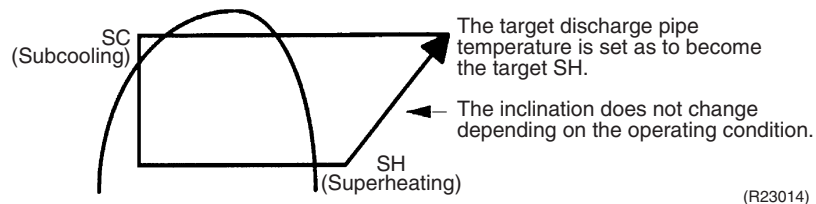

The electronic expansion valve opening and the target discharge pipe temperature are adjusted every **A** seconds. The opening degree of the electronic expansion valve is adjusted by the following.

- ◆ Target discharge pipe temperature
- ◆ Actual discharge pipe temperature
- ◆ Previous discharge pipe temperature

	RK(X)30/36NMVJU
A (seconds)	20

3.12 Malfunctions

3.12.1 Sensor Malfunction Detection

Sensor malfunction can be detected in the following thermistors:

1. Outdoor heat exchanger thermistor
2. Discharge pipe thermistor
3. Radiation fin thermistor
4. Outdoor temperature thermistor

3.12.2 Detection of Overcurrent and Overload

Outline

An excessive output current is detected and the OL temperature is observed to protect the compressor.

Details

- If the OL (compressor head) temperature exceeds 130°C (266°F), the system shuts down the compressor.
- If the inverter current exceeds 20 A, the system shuts down the compressor.
The upper limit of the current decreases when the outdoor temperature exceeds a certain level.

Part 5

Remote Controller

1. Remote Controller 48

1. Remote Controller

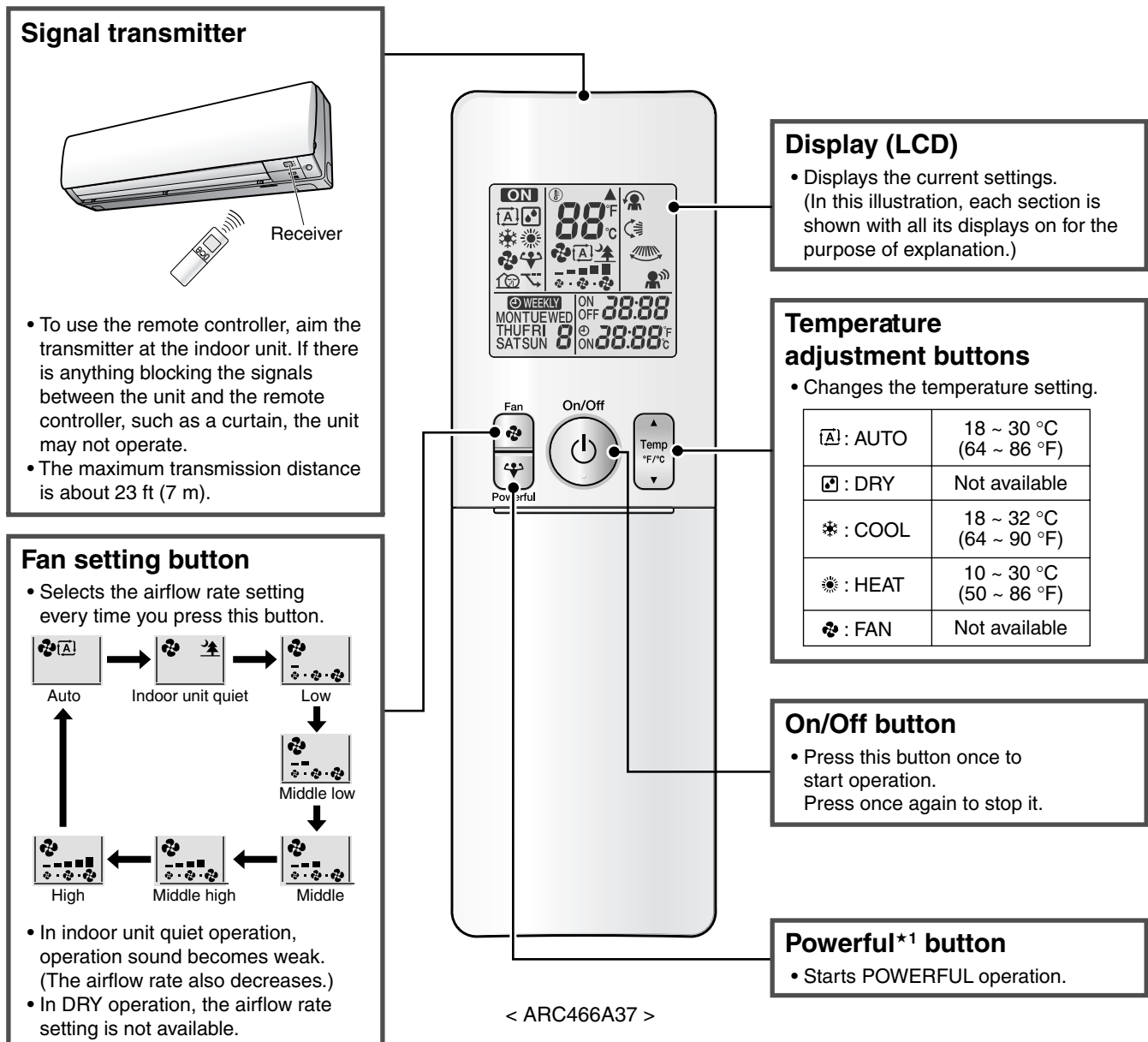

(R24530)

Reference

Refer to the following pages for details.

★1	POWERFUL operation	P.22
----	--------------------	------



Note:

Refer to the operation manual of applicable model for details. You can download operation manuals from Daikin Business Portal:
 Daikin Business Portal → Document Search → Item Category → Installation/Operation Manual
 (URL: https://global1d.daikin.com/business_portal/login/)

Open the Front Cover

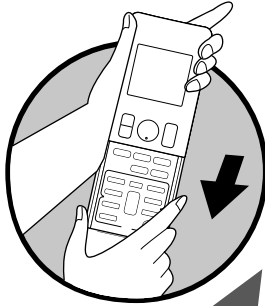

Mode button

- Selects the operation mode.

Comfort/Sensor button (COMFORT AIRFLOW Operation*2/ INTELLIGENT EYE Operation*3)

- Every time you press **Comfort/Sensor** button, the setting changes in the following order.

Econo*4 / Quiet button

- Every time you press **Econo/Quiet** button, the setting changes in the following order.

- OUTDOOR UNIT QUIET operation is not available in FAN and DRY operation.
- OUTDOOR UNIT QUIET operation and ECONO operation cannot be used at the same time with POWERFUL operation. Priority is given to the function you pressed last.

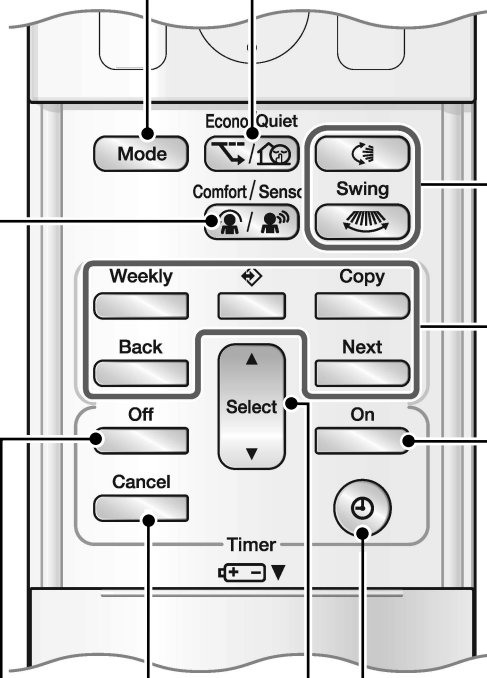

Swing*5 buttons

- Adjusts the airflow direction.
- When you press **Swing** button, the flap moves up and down, or (and) the louver moves right and left. The flap (louver) stops when you press **Swing** button again.

Off Timer button (NIGHT SET mode)

- Press this button and adjust the day of the week and time with **Select** button. Press this button again to complete **TIMER** setting.

Select button

- Changes the ON/OFF **TIMER** and **WEEKLY** **TIMER** settings.

Weekly button (WEEKLY TIMER Operation*6)

- Weekly
- Program button
- Copy
- Copy button
- Back
- Back button
- Next
- Next button

Timer Cancel button

- Cancels the timer setting.
- It cannot be used for the **WEEKLY** **TIMER** operation.

Clock*7 button

On Timer button

- Press this button and adjust the day of the week and time with **Select** button. Press this button again to complete **TIMER** setting.

(R24630)

Reference

Refer to the following pages for details.

★2	COMFORT AIRFLOW	P.15, 16
★3	INTELLIGENT EYE operation	P.21
★4	ECONO operation	P.20

★5	Auto-swing	P.15
★6	WEEKLY TIMER operation	P.24
★7	Clock setting	P.23



Note:

Refer to the operation manual of applicable model for details. You can download operation manuals from Daikin Business Portal:
 Daikin Business Portal → Document Search → Item Category → Installation/Operation Manual
 (URL: https://global1d.daikin.com/business_portal/login/)

Part 6

Service Diagnosis

1. General Problem Symptoms and Check Items	52
2. Troubleshooting with LED	53
2.1 Indoor Unit.....	53
2.2 Outdoor Unit.....	53
3. Service Diagnosis	54
4. Troubleshooting	57
4.1 Error Codes and Description	57
4.2 Indoor Unit PCB Abnormality	58
4.3 Freeze-up Protection Control/Heating Peak-cut Control	60
4.4 Indoor Fan Motor (DC Motor) or Related Abnormality	61
4.5 Thermistor or Related Abnormality (Indoor Unit).....	63
4.6 Low-voltage Detection or Over-voltage Detection.....	64
4.7 Signal Transmission Error (between Indoor Unit and Outdoor Unit)	66
4.8 Signal Transmission Error on Outdoor Unit PCB	68
4.9 Mismatching of Indoor Unit and Outdoor Unit	69
4.10 Outdoor Unit PCB Abnormality.....	70
4.11 OL Activation (Compressor Overload)	71
4.12 Compressor Lock	73
4.13 DC Fan Lock (Outdoor Fan).....	74
4.14 Input Overcurrent Detection	75
4.15 Four Way Valve Abnormality.....	76
4.16 Discharge Pipe Temperature Control.....	78
4.17 High Pressure Control in Cooling	79
4.18 System Shutdown due to Compressor Internal Temperature Abnormality	80
4.19 Compressor System Sensor Abnormality	81
4.20 Position Sensor Abnormality	82
4.21 CT or Related Abnormality	84
4.22 Thermistor or Related Abnormality (Outdoor Unit).....	86
4.23 Electrical Box Temperature Rise.....	88
4.24 Radiation Fin Temperature Rise	89
4.25 Output Overcurrent Detection	90
5. Check.....	92
5.1 Thermistor Resistance Check	92
5.2 Indoor Fan Motor Connector Output Check	93
5.3 Power Supply Waveforms Check.....	93
5.4 Electronic Expansion Valve Check.....	94
5.5 Four Way Valve Performance Check.....	95
5.6 Inverter Unit Refrigerant System Check.....	95
5.7 Inverter Analyzer Check.....	96
5.8 Rotation Pulse Check on the Outdoor Unit PCB.....	98

5.9	Installation Condition Check.....	99
5.10	Discharge Pressure Check.....	99
5.11	Outdoor Fan System Check.....	100
5.12	Main Circuit Short Check.....	100
5.13	Capacitor Voltage Check.....	101
5.14	Power Module Check.....	101

1. General Problem Symptoms and Check Items

Symptom	Check Item	Details	Reference Page
The unit does not operate.	Check the power supply.	Check if the rated voltage is supplied.	—
	Check the type of the indoor unit.	Check if the indoor unit type is compatible with the outdoor unit.	—
	Check the outdoor temperature.	Heating/cooling operations are not available when the outdoor temperature is out of the operation limit. Check the reference page for the operation limit.	117
	Diagnose with remote controller indication.	—	57
	Check the remote controller addresses.	Check if address settings for the remote controller and indoor unit are correct.	108
Operation sometimes stops.	Check the power supply.	A power failure of 2 to 10 cycles stops air conditioner operation. (Operation lamp OFF)	—
	Check the outdoor temperature.	Heating/cooling operations are not available when the outdoor temperature is out of the operation limit. Check the reference page for the operation limit.	117
	Diagnose with remote controller indication.	—	57
The unit operates but does not cool, or does not heat.	Check for wiring and piping errors in the connection between the indoor unit and outdoor unit.	—	—
	Check for thermistor detection errors.	Check if the thermistor is mounted securely.	—
	Check for faulty operation of the electronic expansion valve.	Set the unit to cooling operation, and check the temperature of the liquid pipe to see if the electronic expansion valve works.	—
	Diagnose with remote controller indication.	—	57
	Diagnose by service port pressure and operating current.	Check for refrigerant shortage.	—
Large operating noise and vibrations	Check the output voltage of the power module.	—	101
	Check the power module.	—	—
	Check the installation condition.	Check if the required spaces for installation (specified in the installation manual) are provided.	—

2. Troubleshooting with LED

2.1 Indoor Unit

Operation Lamp

The operation lamp blinks when any of the following errors is detected.

1. A protection device of the indoor or outdoor unit is activated, or the thermistor malfunctions.
2. A signal transmission error occurs between the indoor and outdoor units.

In either case, conduct the diagnostic procedure described in the following pages.

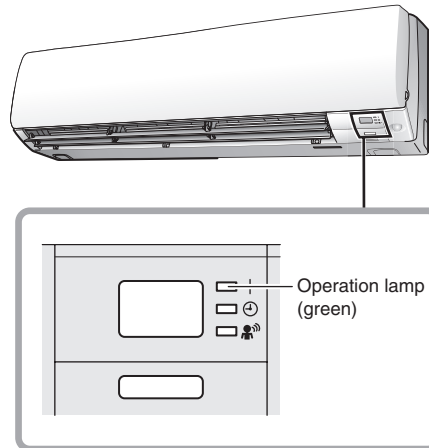

(R24553)

2.2 Outdoor Unit

The outdoor unit has one green LED (LED A) on the PCB. When the microcomputer works in order, the LED A blinks. However, the LED A turns OFF while the standby electricity saving function is activated and the power supply is OFF. (Refer to page 9 for the location of LED A.)

3. Service Diagnosis

Method 1

- When **Timer Cancel** button is held down for 5 seconds, **00** is displayed on the temperature display screen.

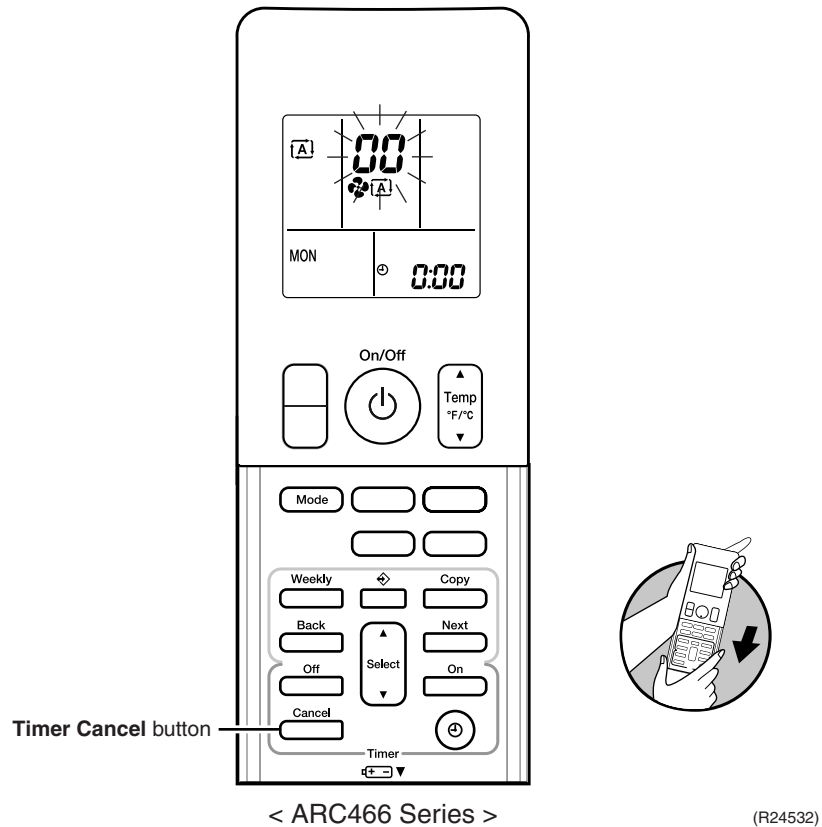

- Press **Timer Cancel** button repeatedly until a long beep sounds.

■ The code indication changes in the sequence shown below.

ARC466A37

No.	Code	No.	Code	No.	Code
1	00	14	U0	27	UR
2	R5	15	C7	28	UX
3	E7	16	R3	29	P4
4	F3	17	K8	30	K7
5	F6	18	K9	31	U2
6	L3	19	C9	32	ER
7	L4	20	C4	33	RX
8	L5	21	C5	34	FR
9	U4	22	J3	35	K1
10	E6	23	J6	36	P9
11	K6	24	E5	37	E3
12	K0	25	R1	38	K3
13	R6	26	E1		



Notes:

- A short beep or two consecutive beeps indicate non-corresponding codes.
- To return to the normal mode, hold down **Timer Cancel** button for 5 seconds. When the remote controller is left untouched for 60 seconds, it also returns to the normal mode.
- Not all the error codes are displayed. When you cannot find the error code, try method 2. (→ Refer to page 55.)

Method 2

1. Press the center of **Temp** button and **Mode** button at the same time.

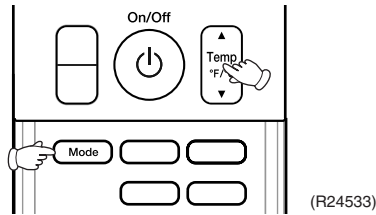

5ℓ is displayed on the LCD.

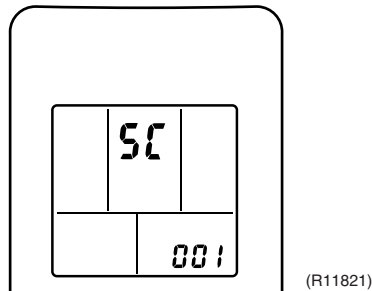

2. Select 5ℓ (service check) with **Temp ▲** or **Temp ▼** button.
3. Press **Mode** button to enter the service check mode.

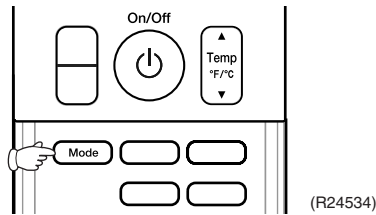

The left-side number blinks.

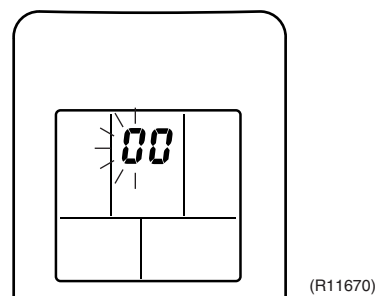

4. Press **Temp ▲** or **Temp ▼** button and change the number until you hear the two consecutive beeps or the long beep.

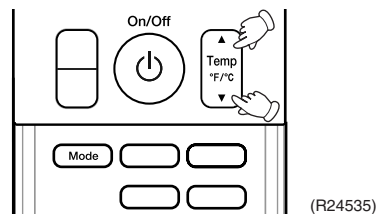

5. Diagnose by the sound.
 - ★ beep: The left-side number does not correspond with the error code.
 - ★ two consecutive beeps: The left-side number corresponds with the error code but the right-side number does not.
 - ★ long beep: Both the left-side and right-side numbers correspond with the error code.
The numbers indicated when you hear the long beep are the error code.
Refer to page 57.

6. Press **Mode** button.

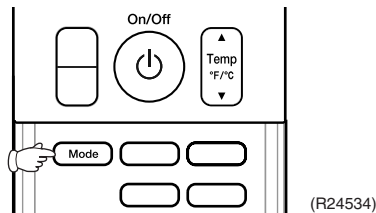

The right-side number blinks.

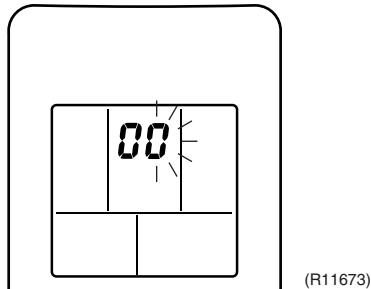

7. Press **Temp ▲** or **Temp ▼** button and change the number until you hear the long beep.

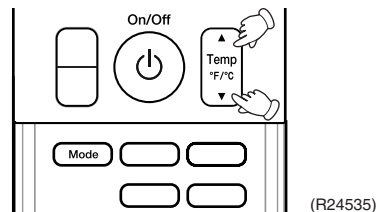

8. Diagnose by the sound.
 - ★ beep: The left-side number does not correspond with the error code.
 - ★ two consecutive beeps: The left-side number corresponds with the error code but the right-side number does not.
 - ★ long beep: Both the left-side and right-side numbers correspond with the error code.
9. Determine the error code.
The numbers indicated when you hear the long beep are the error code.
Refer to page 57.

10. Press **Mode** button for 5 seconds to exit from the service check mode.
(When the remote controller is left untouched for 60 seconds, it returns to the normal mode also.)

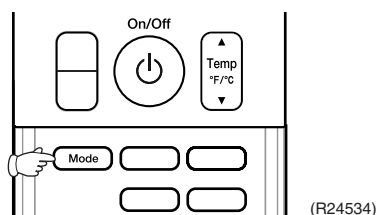

4. Troubleshooting

4.1 Error Codes and Description

	Error Codes	Description	Reference Page
System	00	Normal	—
	U2	Low-voltage detection or over-voltage detection	64
	U4	Signal transmission error (between indoor unit and outdoor unit)	66
	UR	Mismatching of indoor unit and outdoor unit	69
Indoor Unit	R1	Indoor unit PCB abnormality	58
	RS	Freeze-up protection control/heating peak-cut control	60
	RE	Indoor fan motor (DC motor) or related abnormality	61
	LY	Indoor heat exchanger thermistor or related abnormality	63
	CS	Room temperature thermistor or related abnormality	63
Outdoor Unit	E1	Outdoor unit PCB abnormality	70
	E5★	OL activation (compressor overload)	71
	E6★	Compressor lock	73
	E7★	DC fan lock (outdoor fan)	74
	E8	Input overcurrent detection	75
	ER	Four way valve abnormality	76
	F3	Discharge pipe temperature control	78
	F6	High pressure control in cooling	79
	F8	System shutdown due to compressor internal temperature abnormality	80
	H0	Compressor system sensor abnormality	81
	H6	Position sensor abnormality	82
	H8	CT or related abnormality	84
	H9	Outdoor temperature thermistor or related abnormality	86
	J3★	Discharge pipe thermistor or related abnormality	86
	U5	Outdoor heat exchanger thermistor or related abnormality	86
	L3	Electrical box temperature rise	88
	L4	Radiation fin temperature rise	89
	L5★	Output overcurrent detection	90
	P4	Radiation fin thermistor or related abnormality	86
	U7	Signal transmission error on outdoor unit PCB	68

★: Displayed only when system-down occurs.

4.2 Indoor Unit PCB Abnormality

Error Code	A1
Method of Error Detection	The system checks if the circuit works properly within the microcomputer of the indoor unit.
Error Decision Conditions	The system cannot set the internal settings.
Supposed Causes	<ul style="list-style-type: none">■ Wrong models interconnected■ Defective indoor unit PCB■ Disconnection of connector■ Reduction of power supply voltage

Troubleshooting



Caution Be sure to turn off the power switch before connecting or disconnecting connectors, or parts may be damaged.

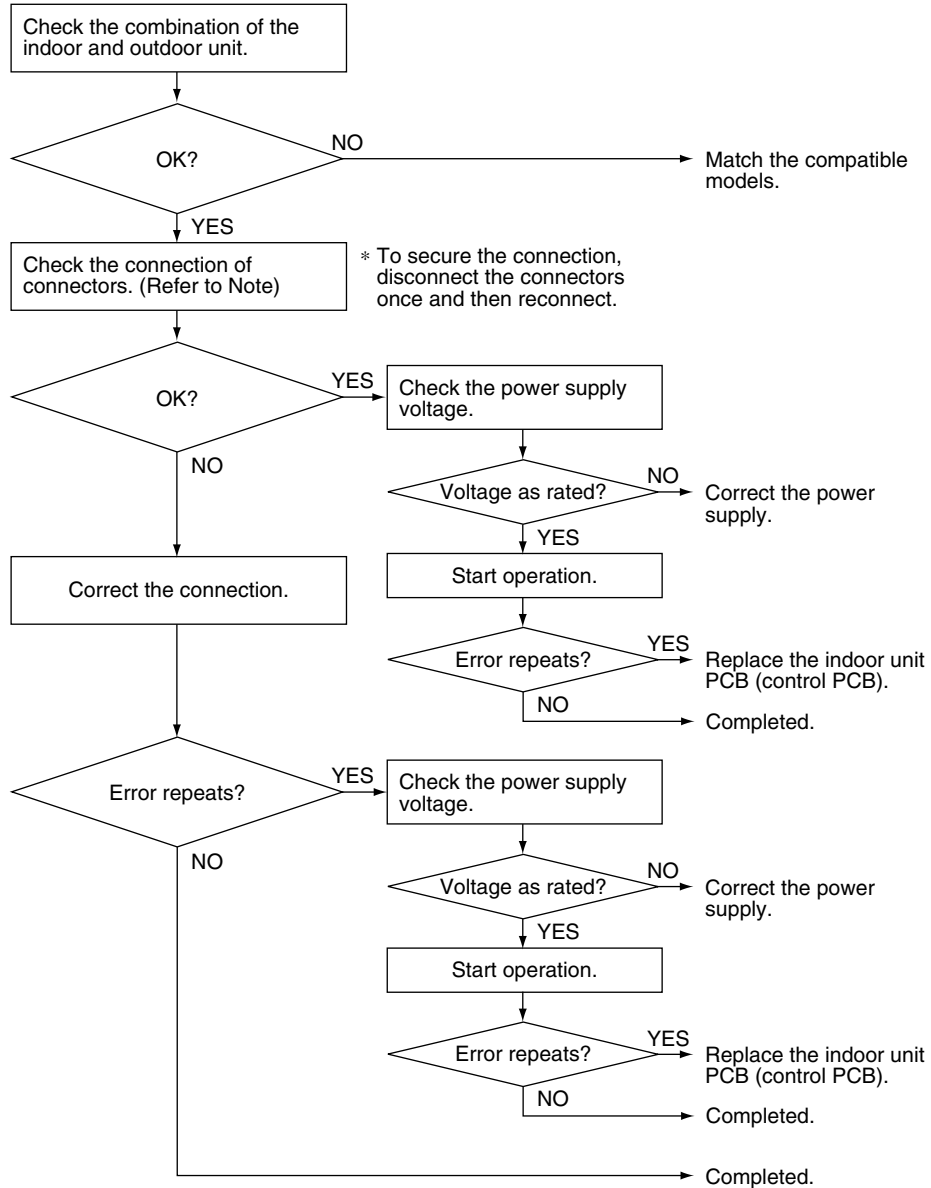

(R23407)



Note: Check the following connector.

Model Type	Connector
Wall mounted type	Terminal strip ~ Control PCB (H1, H2, H3)

4.3 Freeze-up Protection Control/Heating Peak-cut Control

Error Code	A5
Method of Error Detection	<ul style="list-style-type: none"> ■ Freeze-up protection control During cooling operation, the freeze-up protection control (operation halt) is activated according to the temperature detected by the indoor heat exchanger thermistor. ■ Heating peak-cut control During heating operation, the temperature detected by the indoor heat exchanger thermistor is used for the heating peak-cut control (operation halt, outdoor fan stop, etc.)
Error Decision Conditions	<ul style="list-style-type: none"> ■ Freeze-up protection control During cooling operation, the indoor heat exchanger temperature is below 0°C (32°F). ■ Heating peak-cut control During heating operation, the indoor heat exchanger temperature is above about 60°C (140°F) (depending on the model).
Supposed Causes	<ul style="list-style-type: none"> ■ Short-circuited air ■ Clogged air filter of the indoor unit ■ Dust accumulation on the indoor heat exchanger ■ Defective indoor heat exchanger thermistor ■ Defective indoor unit PCB

Troubleshooting



Check No.01
Refer to P.92

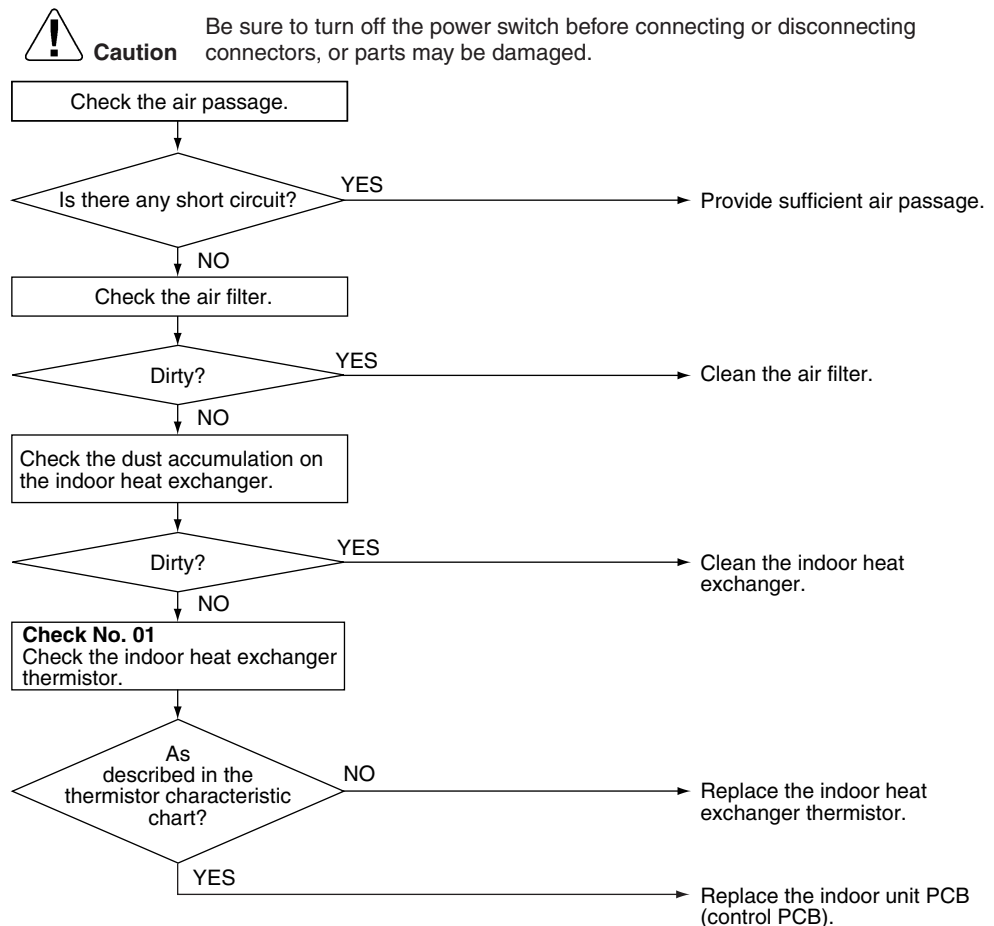

(R21064)

4.4 Indoor Fan Motor (DC Motor) or Related Abnormality

Error Code	R6
Method of Error Detection	The rotation speed detected by the Hall IC during fan motor operation is used to determine abnormal fan motor operation.
Error Decision Conditions	The detected rotation speed does not reach the demanded rotation speed of the target tap, and is less than 50% of the maximum fan motor rotation speed.
Supposed Causes	<ul style="list-style-type: none">■ Remarkable decrease in power supply voltage■ Layer short inside the fan motor winding■ Breaking of wire inside the fan motor■ Breaking of the fan motor lead wires■ Defective capacitor of the fan motor■ Defective indoor unit PCB

Troubleshooting



Check No.02
Refer to P.93



Caution

Be sure to turn off the power switch before connecting or disconnecting connectors, or parts may be damaged.

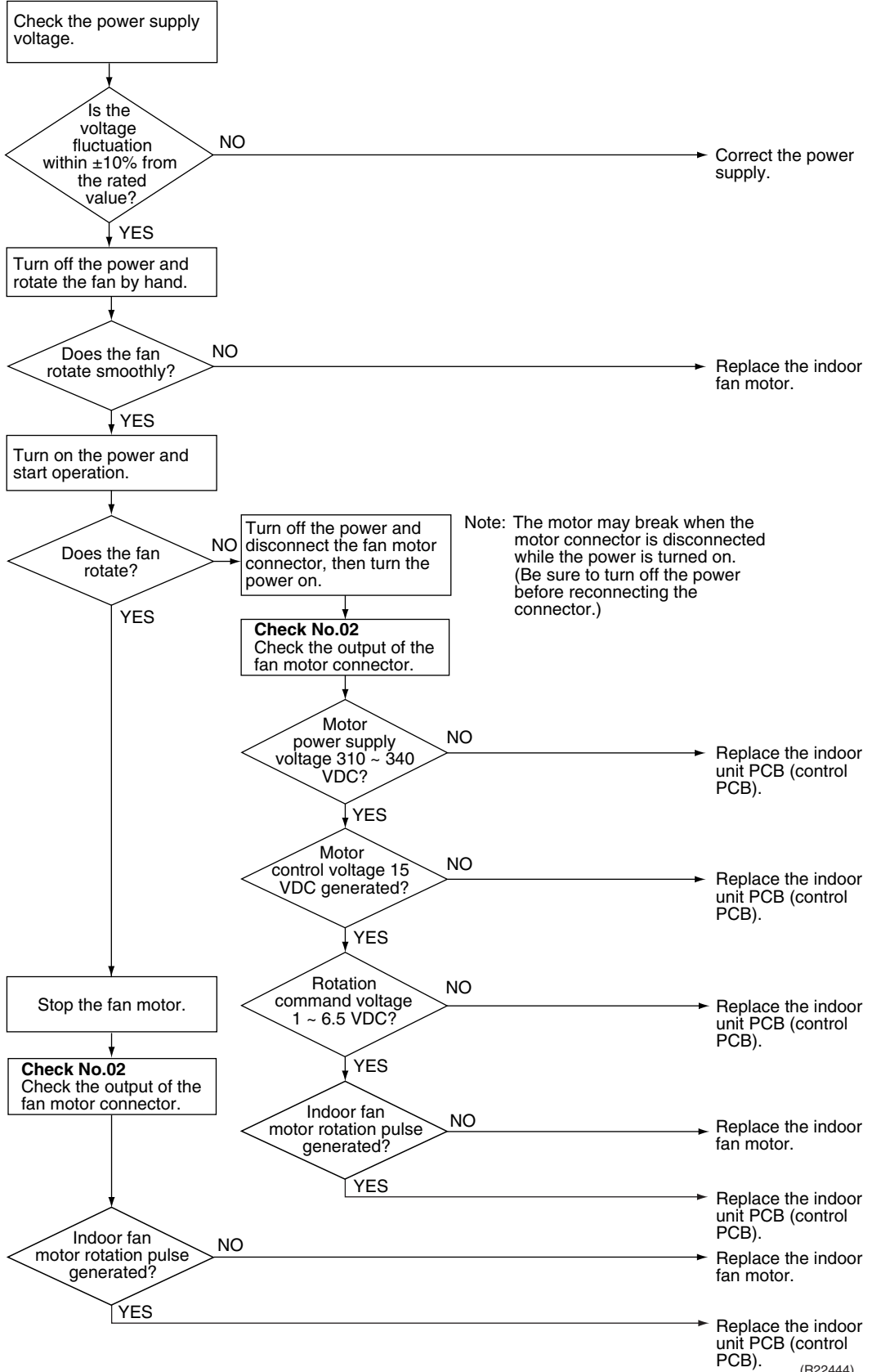

Note: The rotation pulse is the feedback signal from the indoor fan motor.

(R22444)

4.5 Thermistor or Related Abnormality (Indoor Unit)

Error Code	Ⓛ4, Ⓛ9
Method of Error Detection	The temperatures detected by the thermistors determine thermistor errors.
Error Decision Conditions	The voltage between the both ends of the thermistor is either 4.96 V or more, or 0.04 V or less during compressor operation.
Supposed Causes	<ul style="list-style-type: none"> ■ Disconnection of connector ■ Defective thermistor(s) ■ Defective indoor unit PCB

Troubleshooting

 **Check No.01**
Refer to P.92

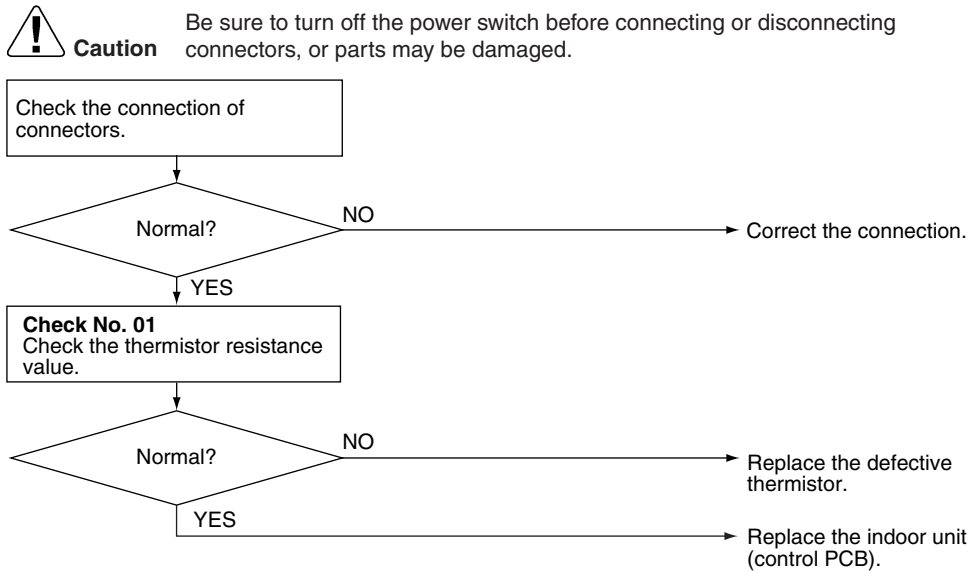

(R21870)

Ⓛ4 : Indoor heat exchanger thermistor
Ⓛ9 : Room temperature thermistor

 **Note:** When replacing the defective thermistor(s), replace the thermistors as ASSY.

4.6 Low-voltage Detection or Over-voltage Detection

Error Code	U2
Method of Error Detection	<p>★ Indoor Unit</p> <p>The zero-cross detection of the power supply is evaluated by the indoor unit PCB.</p> <p>★ Outdoor Unit</p> <p>Low-voltage detection: An abnormal voltage drop is detected by the DC voltage detection circuit.</p> <p>Over-voltage detection: An abnormal voltage rise is detected by the over-voltage detection circuit.</p>
Error Decision Conditions	<p>★ Indoor Unit</p> <p>There is no zero-cross detection in approximately 10 seconds.</p> <p>★ Outdoor Unit</p> <p>Low-voltage detection:</p> <ul style="list-style-type: none"> ■ The voltage detected by the DC voltage detection circuit is below 150 ~ 200 V (depending on the model). ■ The compressor stops if the error occurs, and restarts automatically after 3-minute standby. <p>Over-voltage detection:</p> <ul style="list-style-type: none"> ■ An over-voltage signal is fed from the over-voltage detection circuit to the microcomputer. ■ The compressor stops if the error occurs, and restarts automatically after 3-minute standby.
Supposed Causes	<ul style="list-style-type: none"> ■ Power supply voltage out of specification ■ Defective DC voltage detection circuit ■ Defective over-voltage detection circuit ■ Defective PAM control part ■ Disconnection of compressor harness ■ Short circuit inside the fan motor winding ■ Noise ■ Momentary drop of voltage ■ Momentary power failure ■ Defective outdoor unit PCB ■ Defective indoor unit PCB

Troubleshooting



Caution Be sure to turn off the power switch before connecting or disconnecting connectors, or parts may be damaged.

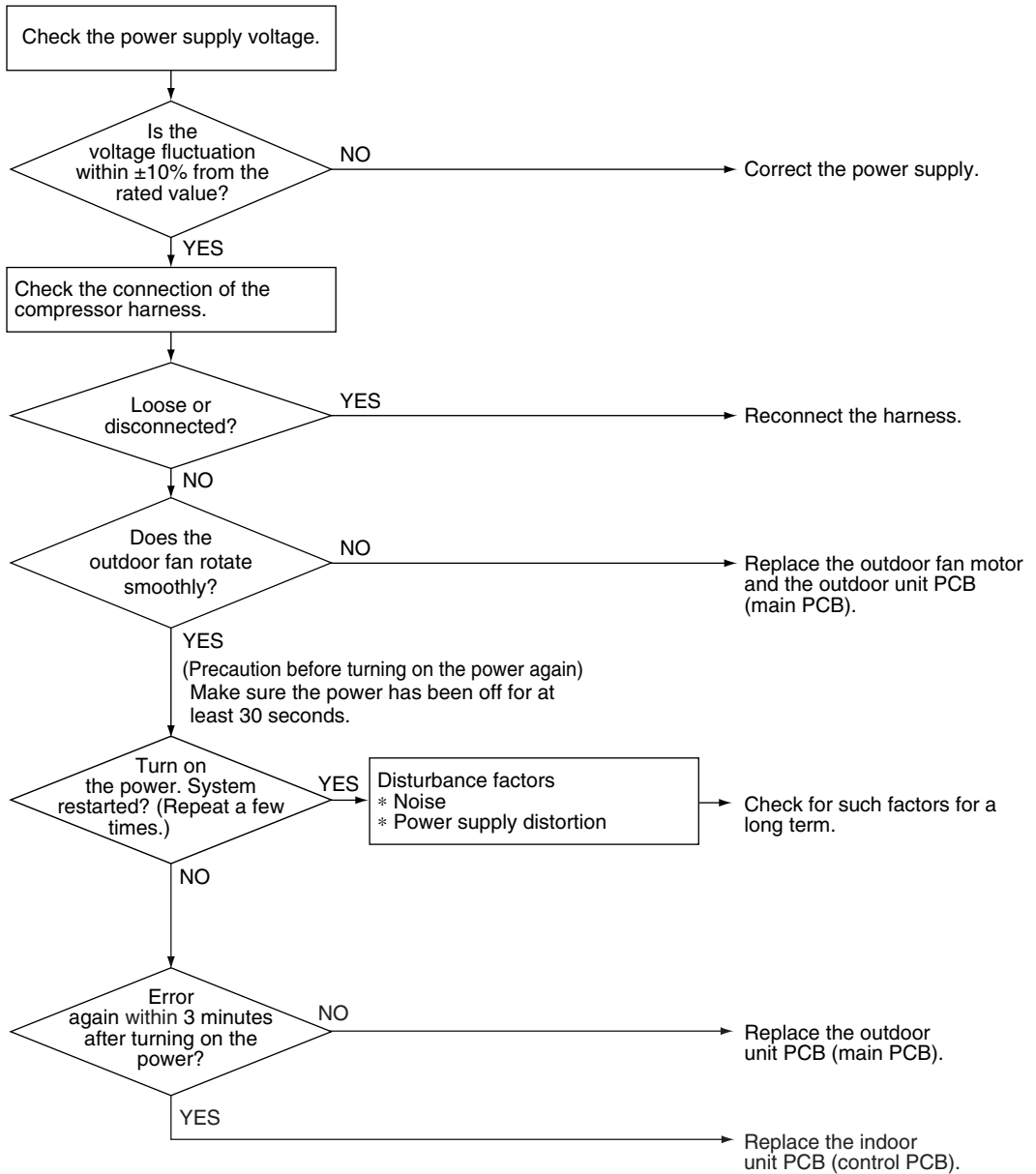

(R22370)

4.7 Signal Transmission Error (between Indoor Unit and Outdoor Unit)

Error Code	U4
Method of Error Detection	The signal transmission data from the outdoor unit is checked whether it is normal.
Error Decision Conditions	The data sent from the outdoor unit cannot be received normally, or the content of the data is abnormal.
Supposed Causes	<ul style="list-style-type: none">■ Power supply voltage out of specification■ Reduction of power supply voltage■ Wiring error■ Breaking of the connecting wires between the indoor and outdoor units (wire No. 3)■ Defective outdoor unit PCB■ Short circuit inside the fan motor winding■ Defective indoor unit PCB■ Disturbed power supply waveform

Troubleshooting



Check No.11
Refer to P.93



Caution Be sure to turn off the power switch before connecting or disconnecting connectors, or parts may be damaged.

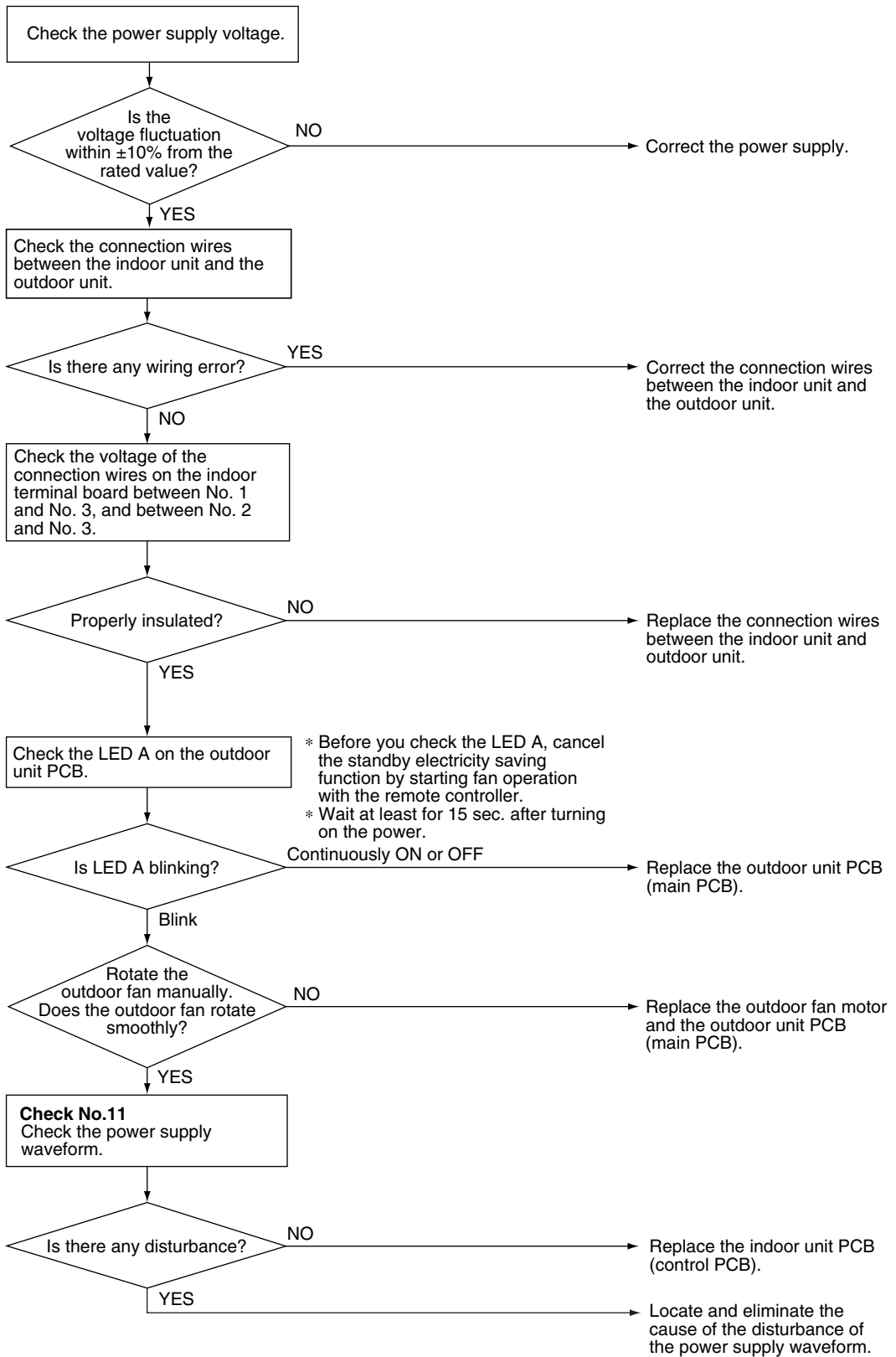

(R24631)

4.8 Signal Transmission Error on Outdoor Unit PCB

Error Code

U7

Method of Error Detection

Communication error between microcomputer mounted on the main microcomputer and PM1.

Error Decision Conditions

- The abnormality is determined when the data sent from the PM1 can not be received for 9 seconds.
- The error counter is reset when the data from the PM1 can be successfully received.

Supposed Causes

- Defective outdoor unit PCB

Troubleshooting



Caution

Be sure to turn off the power switch before connecting or disconnecting connectors, or parts may be damaged.

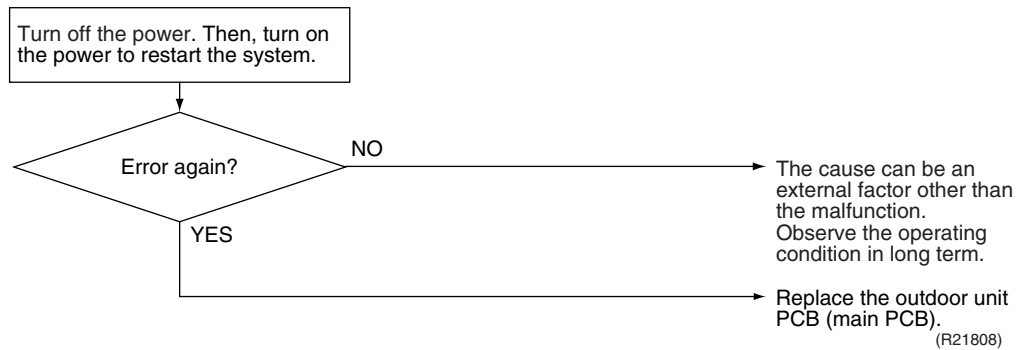

4.9 Mismatching of Indoor Unit and Outdoor Unit

Error Code	UR
Method of Error Detection	Detection from the signal transmission signal between indoor/outdoor units.
Error Decision Conditions	Improper combination of indoor and outdoor units.
Supposed Causes	<ul style="list-style-type: none"> ■ Wrong models interconnected ■ Wrong wiring of connecting wires ■ Wrong indoor unit PCB or outdoor unit PCB mounted ■ Defective indoor unit PCB ■ Defective outdoor unit PCB

Troubleshooting

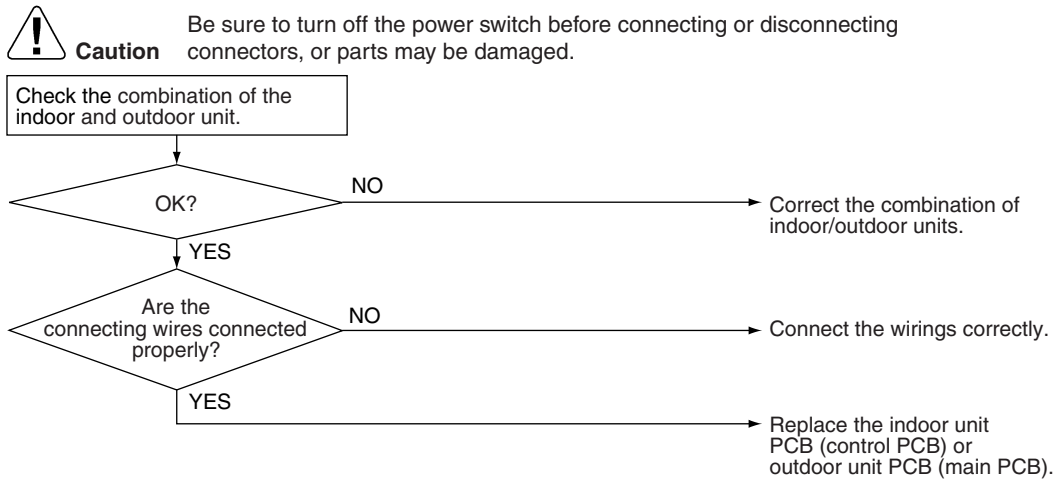

(R24632)

4.10 Outdoor Unit PCB Abnormality

Error Code	E1
Method of Error Detection	<ul style="list-style-type: none"> ■ The system checks if the microprocessor is working in order. ■ The system checks if the zero-cross signal comes in properly.
Error Decision Conditions	<ul style="list-style-type: none"> ■ The microprocessor program runs out of control. ■ The zero-cross signal is not detected.
Supposed Causes	<ul style="list-style-type: none"> ■ Defective outdoor unit PCB ■ Noise ■ Momentary drop of voltage ■ Momentary power failure

Troubleshooting

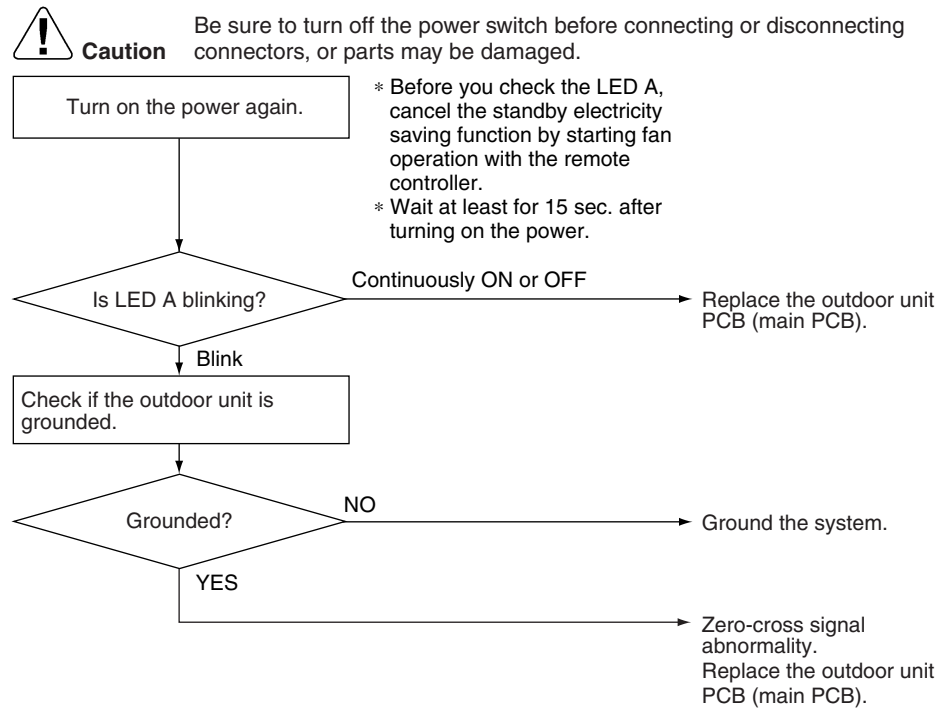

4.11 OL Activation (Compressor Overload)

Error Code	E5
Method of Error Detection	A compressor overload is detected through compressor OL.
Error Decision Conditions	<ul style="list-style-type: none"> ■ If the error repeats, the system is shut down. ■ Reset condition: Continuous run for about 60 minutes without any other error
Supposed Causes	<ul style="list-style-type: none"> ■ Disconnection of discharge pipe thermistor ■ Defective discharge pipe thermistor ■ Disconnection of connector S40 ■ Disconnection of 2 terminals of OL (Q1L) ■ Defective OL (Q1L) ■ Broken OL harness ■ Defective electronic expansion valve or coil ■ Defective four way valve or coil ■ Defective outdoor unit PCB ■ Refrigerant shortage ■ Water mixed in refrigerant ■ Defective stop valve

Troubleshooting



Check No.01
Refer to P.92



Check No.12
Refer to P.94



Check No.13
Refer to P.95



Check No.14
Refer to P.95



Caution

Be sure to turn off the power switch before connecting or disconnecting connectors, or parts may be damaged.

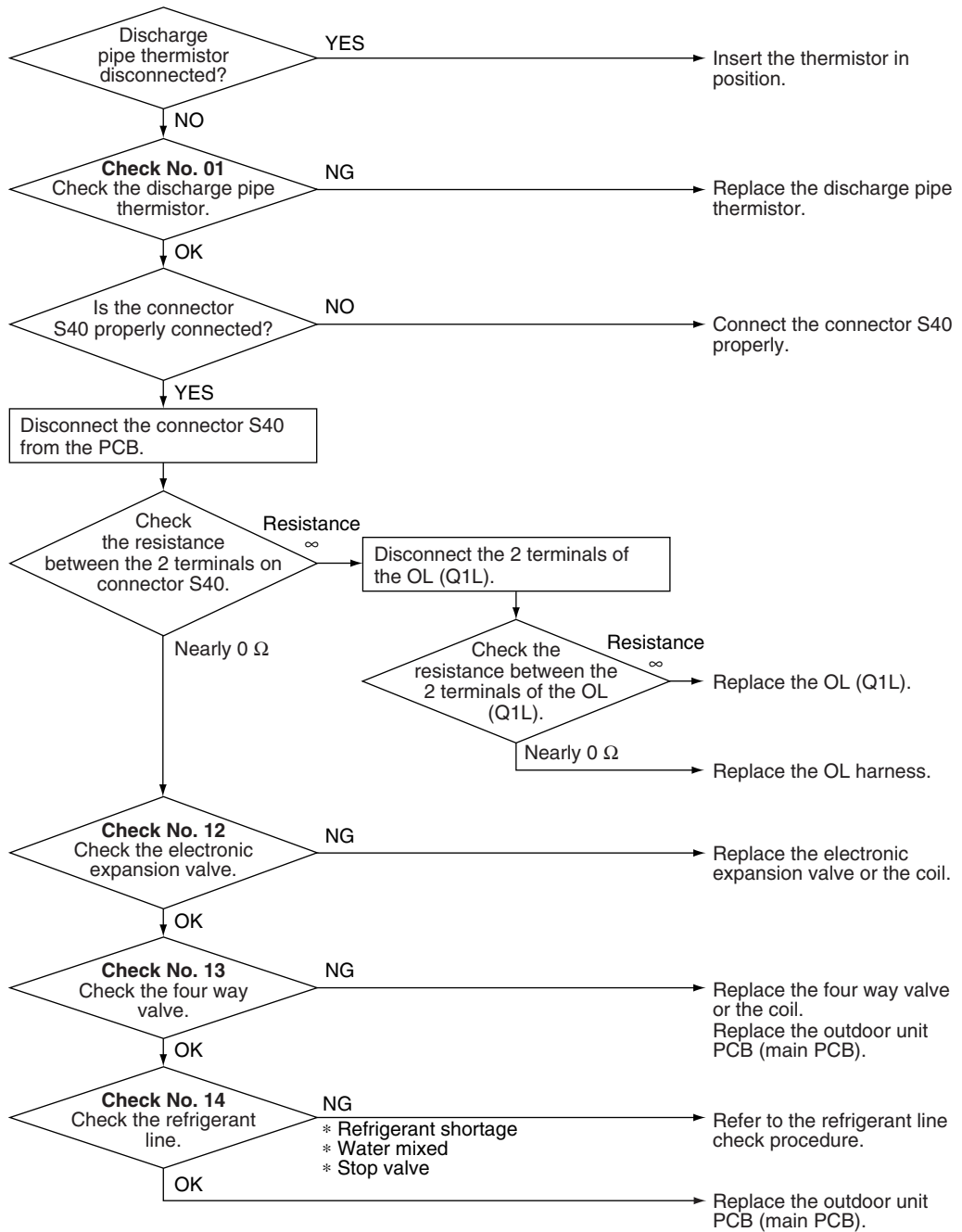

Note:

OL (Q1L) activating temperature: 130°C (266°F)
OL (Q1L) recovery temperature: 95°C (203°F)

(R22976)

4.12 Compressor Lock

Error Code	EE
Method of Error Detection	A compressor lock is detected by the current waveform generated when applying high-frequency voltage to the motor.
Error Decision Conditions	<ul style="list-style-type: none"> ■ If the error repeats, the system is shut down. ■ Reset condition: Continuous run for about 11 minutes without any other error
Supposed Causes	<ul style="list-style-type: none"> ■ Closed stop valve ■ Compressor locked ■ Disconnection of compressor harness

Troubleshooting

Check No.12
 Refer to P.94

Check No.15
 Refer to P.96

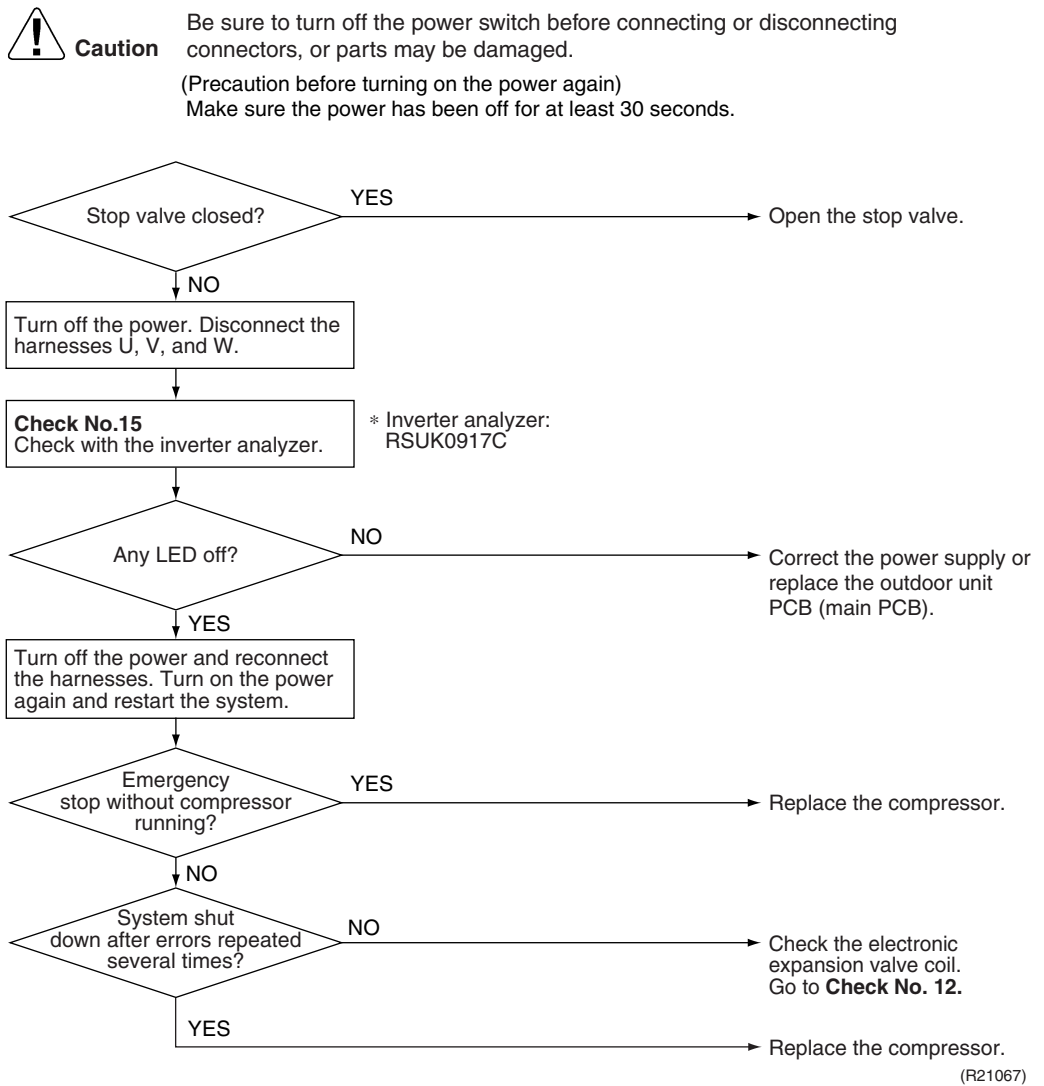

4.13 DC Fan Lock (Outdoor Fan)

Error Code

E7

Method of Error Detection

An error is determined with the high-voltage fan motor rotation speed detected by the Hall IC.

Error Decision Conditions

- The fan does not start in 15 ~ 30 seconds even when the fan motor is running.
- If the error repeats, the system is shut down.
- Reset condition: Continuous run for about 11 minutes without any other error

Supposed Causes

- Disconnection of the fan motor
- Foreign matter stuck in the fan
- Defective fan motor
- Defective outdoor unit PCB

Troubleshooting



Check No.16
Refer to P.98

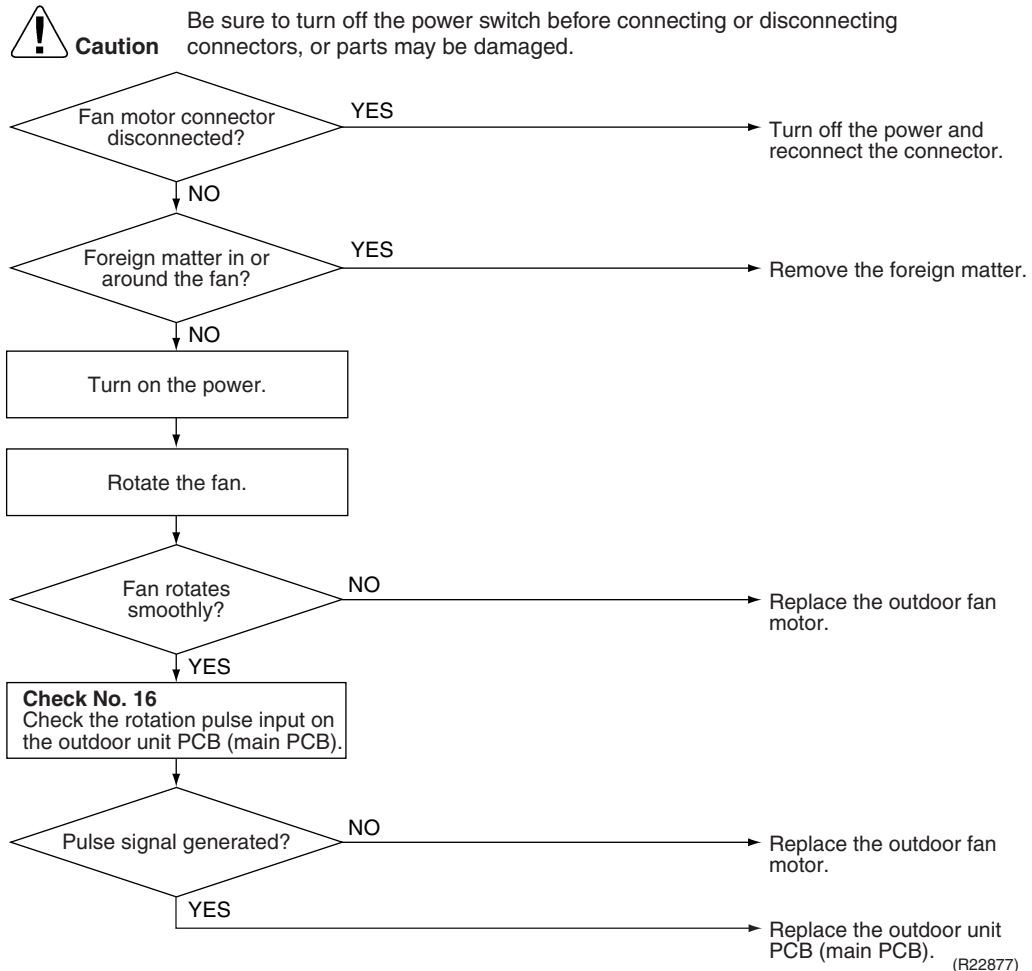

4.14 Input Overcurrent Detection

Error Code	E8
Method of Error Detection	An input overcurrent is detected by checking the input current value with the compressor running.
Error Decision Conditions	The current exceeds about 20 A for 2.5 seconds with the compressor running. (The upper limit of the current decreases when the outdoor temperature exceeds a certain level.)
Supposed Causes	<ul style="list-style-type: none"> ■ Outdoor temperature is out of operation range. ■ Defective compressor ■ Defective power module ■ Defective outdoor unit PCB ■ Short circuit

Troubleshooting

 **Check No.15**
Refer to P.96

 **Check No.17**
Refer to P.99

 **Check No.18**
Refer to P.99

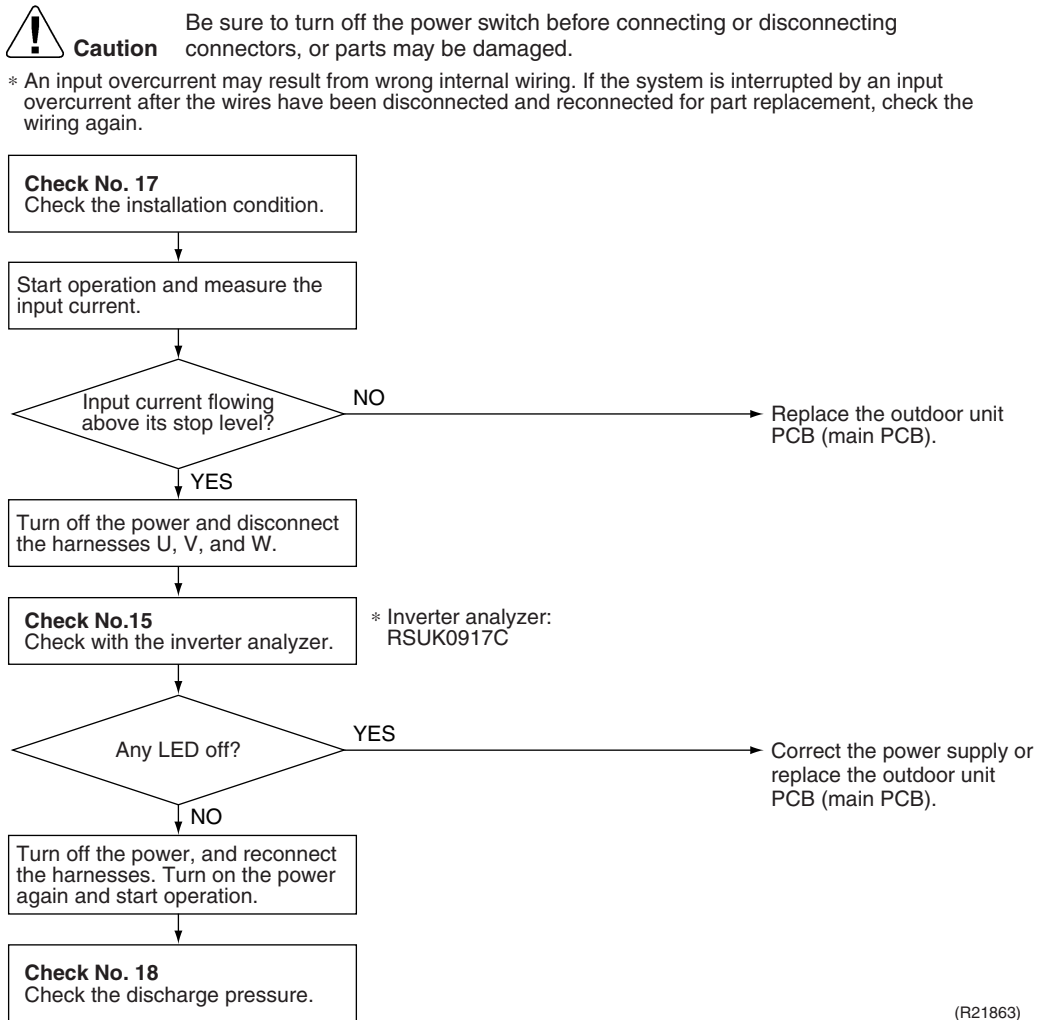

(R21863)

4.15 Four Way Valve Abnormality

Error Code	EA
Method of Error Detection	The room temperature thermistor and the indoor heat exchanger thermistor are checked if they function within their normal ranges in each operation mode.
Error Decision Conditions	<p>The following condition continues over 10 minutes after operating for 5 minutes.</p> <ul style="list-style-type: none"> ■ Cooling/Dry $A - B < -5^{\circ}\text{C}$ ($A - B < -9^{\circ}\text{F}$) ■ Heating $B - A < -5^{\circ}\text{C}$ ($B - A < -9^{\circ}\text{F}$) <p style="margin-left: 40px;"> A: Room thermistor temperature B: Indoor heat exchanger temperature </p> <ul style="list-style-type: none"> ■ If the error repeats, the system is shut down. ■ Reset condition: Continuous run for about 60 minutes without any other error
Supposed Causes	<ul style="list-style-type: none"> ■ Disconnection of four way valve coil ■ Defective four way valve, coil, or harness ■ Defective outdoor unit PCB ■ Defective thermistor(s) ■ Refrigerant shortage ■ Water mixed in refrigerant ■ Defective stop valve

Troubleshooting



Check No.01
Refer to P.92



Check No.13
Refer to P.95



Check No.14
Refer to P.95



Caution Be sure to turn off the power switch before connecting or disconnecting connectors, or parts may be damaged.

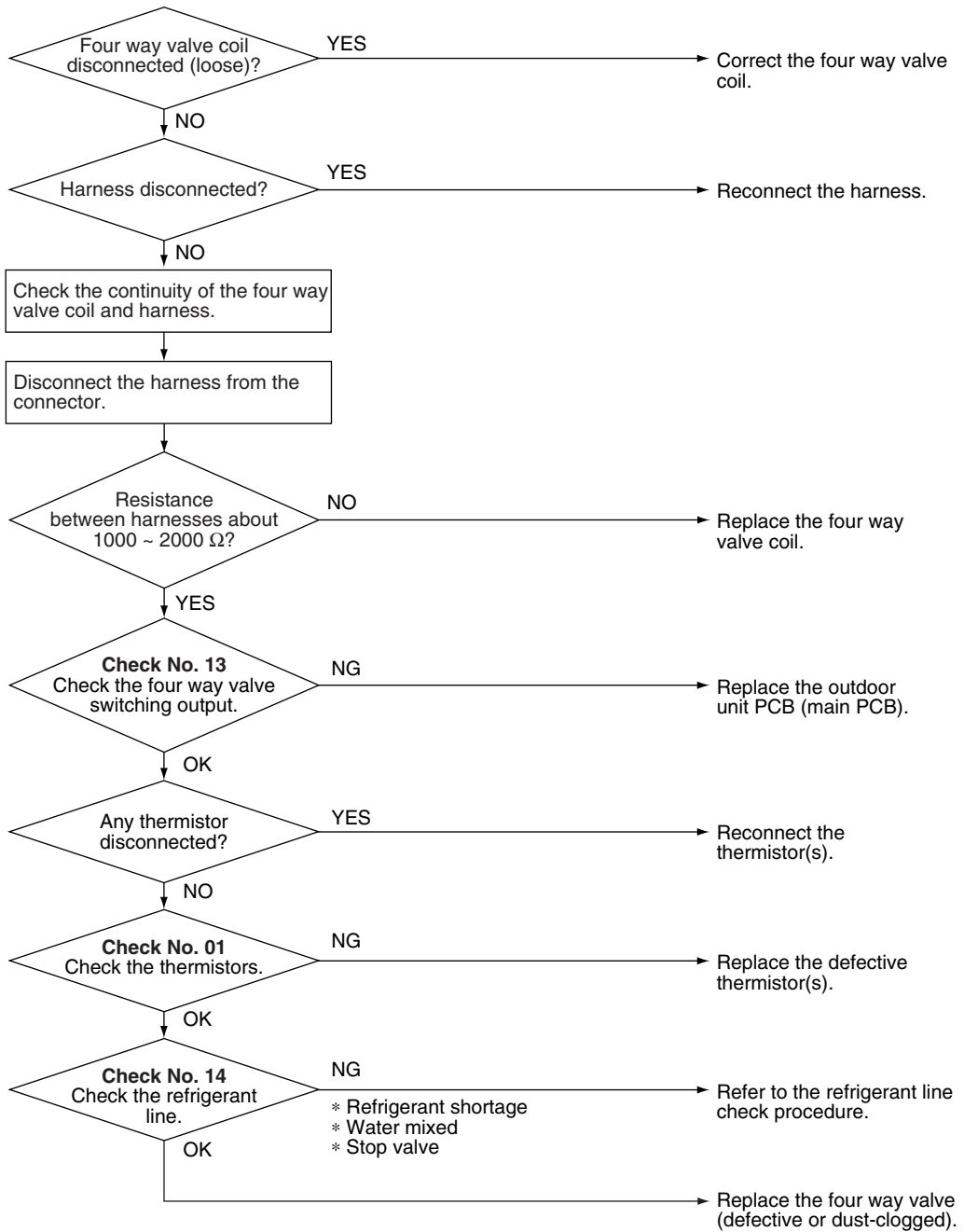

(R20405)

4.16 Discharge Pipe Temperature Control

Error Code



Method of Error Detection

An error is determined with the temperature detected by the discharge pipe thermistor.

Error Decision Conditions

- If the temperature detected by the discharge pipe thermistor rises above **A**, the compressor stops.
- The error is cleared when the discharge pipe temperature has dropped below **B**.

RK(X)30/36NMVJU

A		B	
°C	°F	°C	°F
120	248	107	224.6

- If the error repeats, the system is shut down.
- Reset condition: Continuous run for about 60 minutes without any other error

Supposed Causes

- Defective discharge pipe thermistor
(Defective outdoor heat exchanger thermistor or outdoor temperature thermistor)
- Defective electronic expansion valve or coil
- Refrigerant shortage
- Defective four way valve
- Water mixed in refrigerant
- Defective stop valve
- Defective outdoor unit PCB

Troubleshooting



Check No.01
Refer to P.92



Check No.12
Refer to P.94



Check No.14
Refer to P.95



Caution



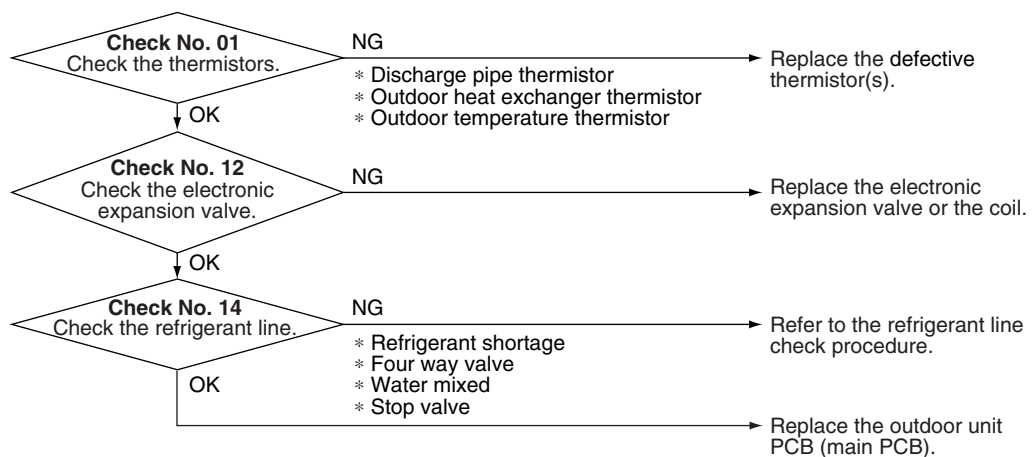

Be sure to turn off the power switch before connecting or disconnecting connectors, or parts may be damaged.



4.17 High Pressure Control in Cooling

Error Code	F6
Method of Error Detection	High-pressure control (operation halt, frequency drop, etc.) is activated in cooling operation if the temperature sensed by the outdoor heat exchanger thermistor exceeds the limit.
Error Decision Conditions	<ul style="list-style-type: none"> ■ The temperature sensed by the outdoor heat exchanger thermistor rise above 60°C (140°F). ■ The error is cleared when the temperature drops below 47°C (116.6°F).
Supposed Causes	<ul style="list-style-type: none"> ■ Installation space not large enough ■ Dirty outdoor heat exchanger ■ Defective outdoor fan motor ■ Defective stop valve ■ Defective electronic expansion valve or coil ■ Defective outdoor heat exchanger thermistor ■ Defective outdoor unit PCB

Troubleshooting

-  **Check No.01**
Refer to P.92
-  **Check No.12**
Refer to P.94
-  **Check No.17**
Refer to P.99
-  **Check No.18**
Refer to P.99
-  **Check No.19**
Refer to P.100

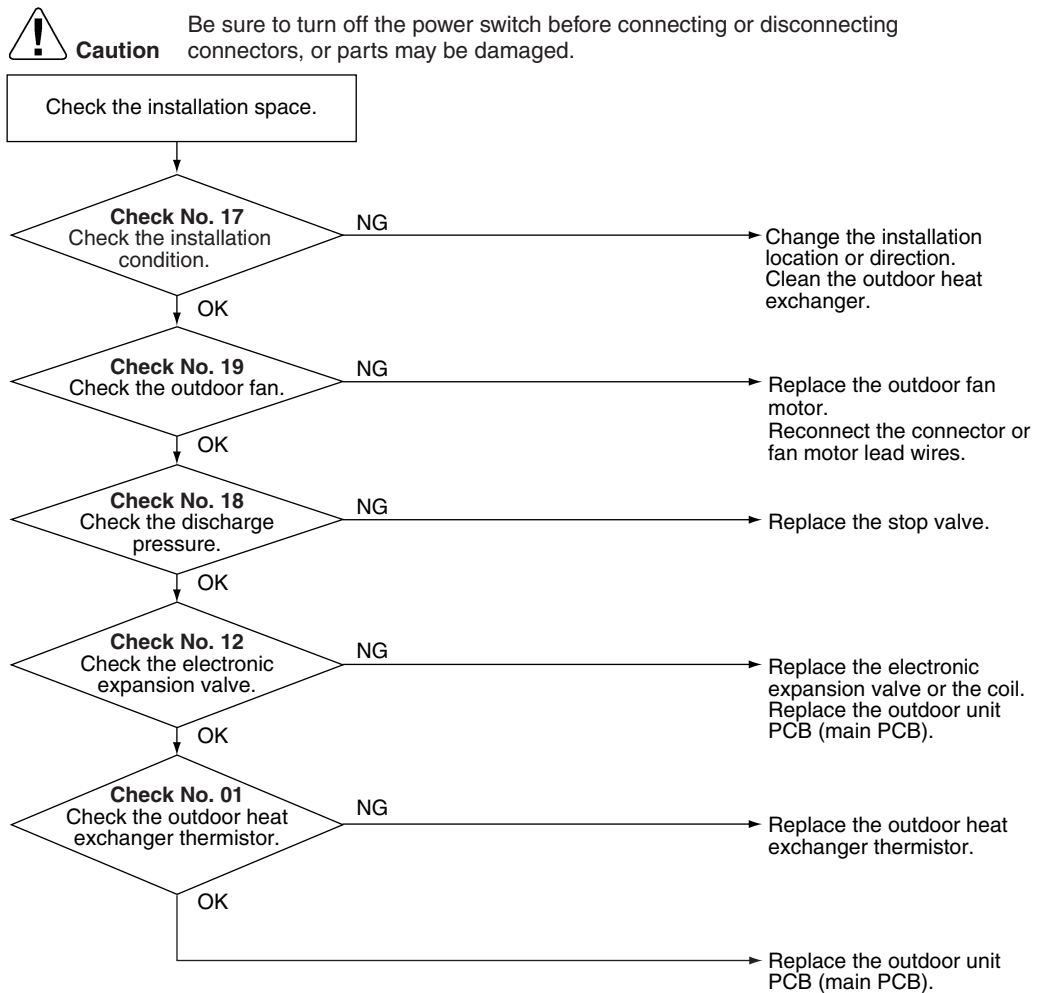

(R20418)

4.18 System Shutdown due to Compressor Internal Temperature Abnormality

Error Code

F8

Method of Error Detection

Operation is halted when the temperature detected by the discharge pipe thermistor exceeds the determined limit.

Error Decision Conditions

Temperature exceeds the detection threshold of 127.5°C during forced cooling operation.

Supposed Causes

- Abnormal operation due to air intrusion
- Defective discharge pipe thermistor

Troubleshooting



Check No.01
Refer to P.92



Caution

Be sure to turn off the power switch before connecting or disconnecting connectors, or parts may be damaged.

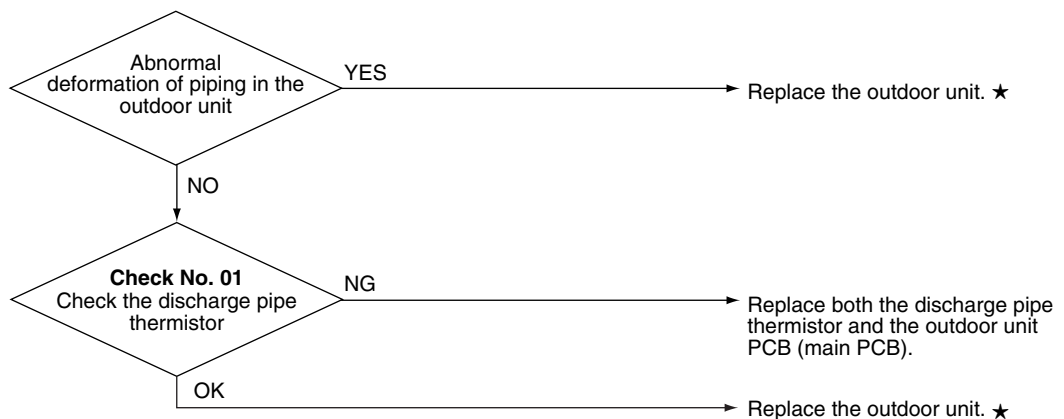

★ Replace the unit as directed in the installation manual, making sure that air does not intrude into the refrigerant pipings.

(R23655)

4.19 Compressor System Sensor Abnormality

Error Code

H0

Method of Error Detection

The system checks the DC current before the compressor starts.

Error Decision Conditions

- The voltage converted from the DC current before compressor start-up is out of the range 0.5 ~ 4.5 V.
- The DC voltage before compressor start-up is below 50 V.

Supposed Causes

- Broken or disconnected harness
- Defective outdoor unit PCB

Troubleshooting

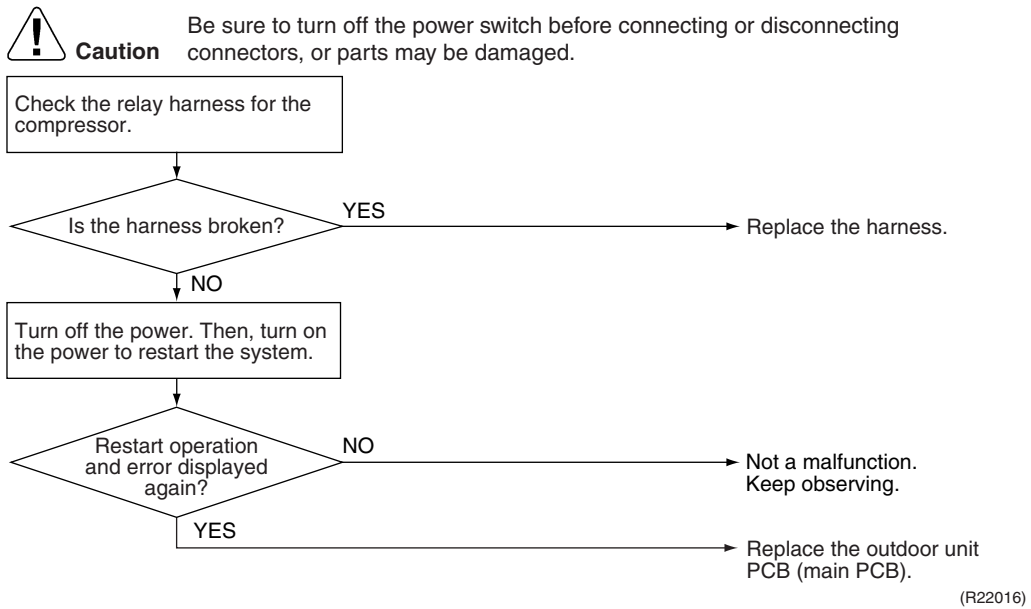

4.20 Position Sensor Abnormality

Error Code	H6
Method of Error Detection	A compressor start-up failure is detected by checking the compressor running condition through the position detection circuit.
Error Decision Conditions	<ul style="list-style-type: none">■ If the error repeats, the system is shut down.■ Reset condition: Continuous run for about 11 minutes without any other error
Supposed Causes	<ul style="list-style-type: none">■ Power supply voltage out of specification■ Disconnection of the compressor harness■ Defective compressor■ Defective outdoor unit PCB■ Start-up failure caused by the closed stop valve■ Input voltage out of specified range

Troubleshooting

Check No.15
 Refer to P.96

Check No.18
 Refer to P.99

Check No.20
 Refer to P.100

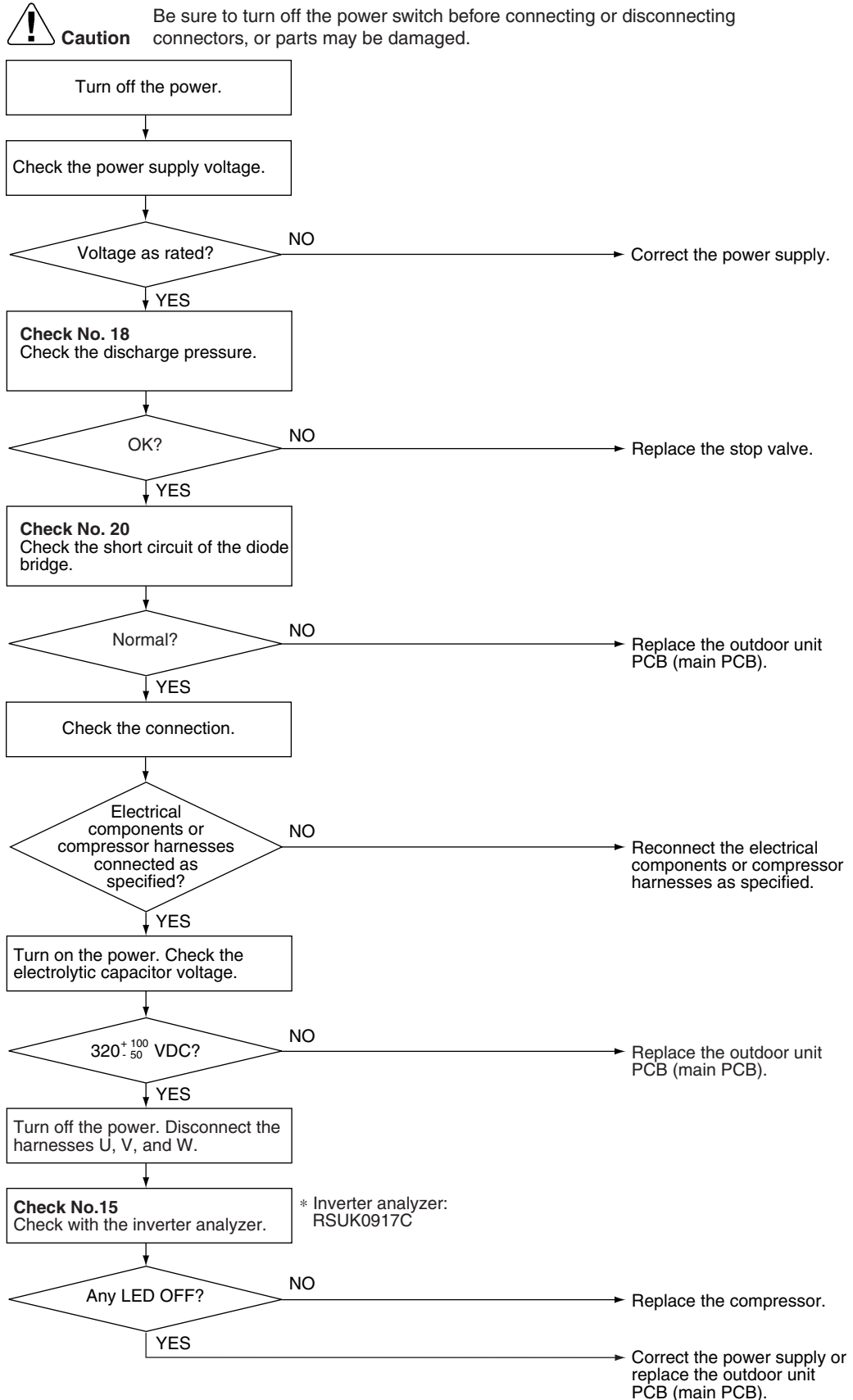

(R21864)

4.21 CT or Related Abnormality

Remote
Controller
Display

HC

Method of
Malfunction
Detection

A CT or related error is detected by checking the compressor running frequency and CT-detected input current.

Malfunction
Decision
Conditions

- The compressor running frequency is more than **A** Hz, and the CT input current is less than **B** A.

A (Hz)	B (A)
32	0.5

- If the error repeats, the system is shut down.
- Reset condition: Continuous run for about 60 minutes without any other error

Supposed
Causes

- Defective power module
- Broken or disconnected wiring
- Defective reactor
- Defective outdoor unit PCB

Troubleshooting



Check No.15
Refer to P.96



Check No.21
Refer to P.101



Caution Be sure to turn off the power switch before connecting or disconnecting connectors, or parts may be damaged.

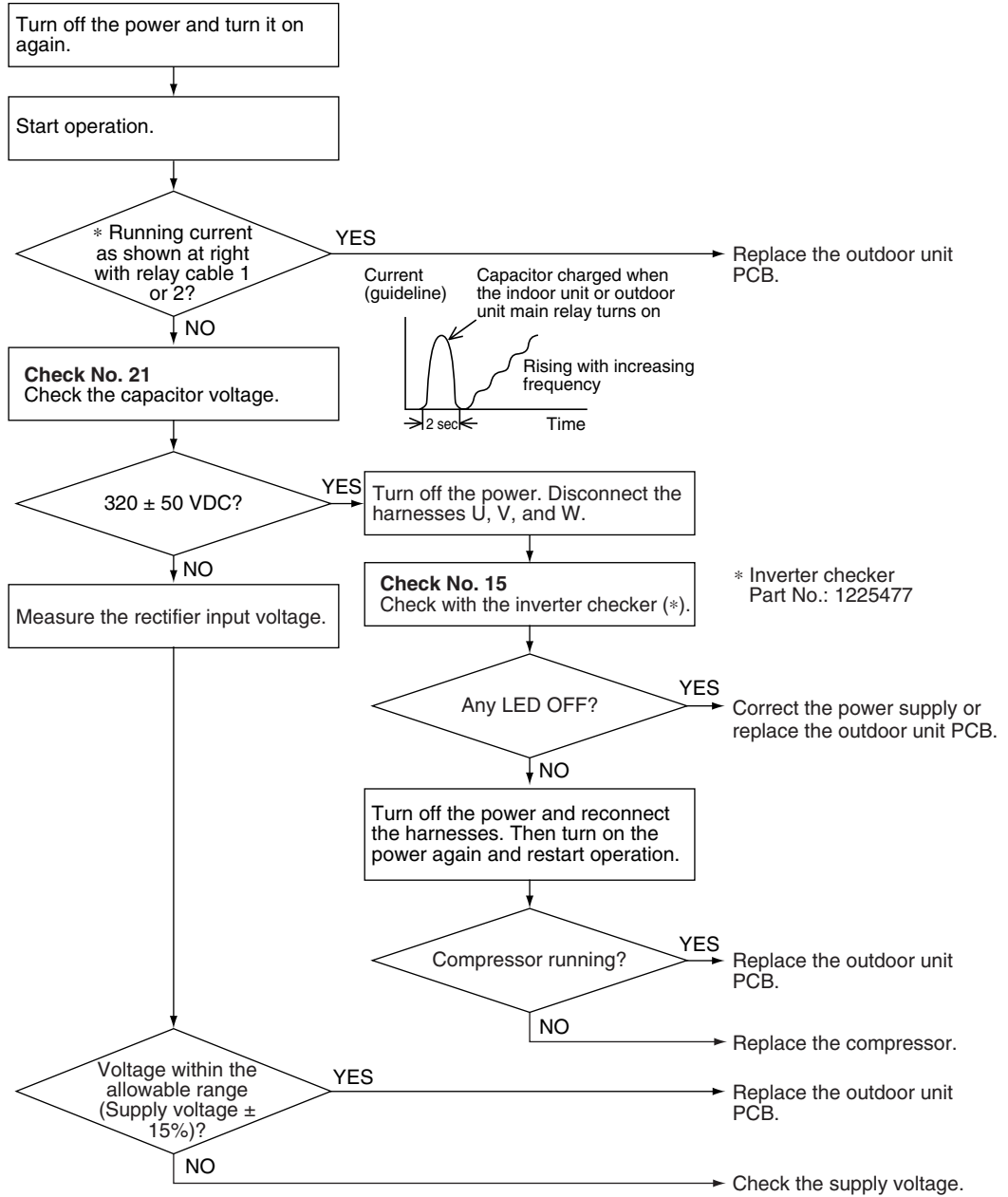

* Inverter checker
Part No.: 1225477

(R15326)

4.22 Thermistor or Related Abnormality (Outdoor Unit)

Error Code	<i>H3, U3, U5, P4</i>
Method of Error Detection	This fault is identified based on the thermistor input voltage to the microcomputer. A thermistor fault is identified based on the temperature sensed by each thermistor.
Error Decision Conditions	<ul style="list-style-type: none"> ■ The voltage between the both ends of the thermistor is either 4.96 V or more, or 0.04 V or less with the power on. ■ <i>U3</i> error is judged if the discharge pipe temperature is lower than the heat exchanger temperature.
Supposed Causes	<ul style="list-style-type: none"> ■ Disconnection of the connector for the thermistor ■ Defective thermistor(s) ■ Defective heat exchanger thermistor in the case of <i>U3</i> error (outdoor heat exchanger thermistor in cooling operation, or indoor heat exchanger thermistor in heating operation) ■ Defective outdoor unit PCB
Troubleshooting	<p>In case of <i>P4</i></p> <p> Caution Be sure to turn off the power switch before connecting or disconnecting connectors, or parts may be damaged.</p> <p>Replace the outdoor unit PCB (main PCB).</p> <p><i>P4</i> : Radiation fin thermistor</p>

Troubleshooting

Check No.01
 Refer to P.92

In case of *H3*, *J3*, *J6*

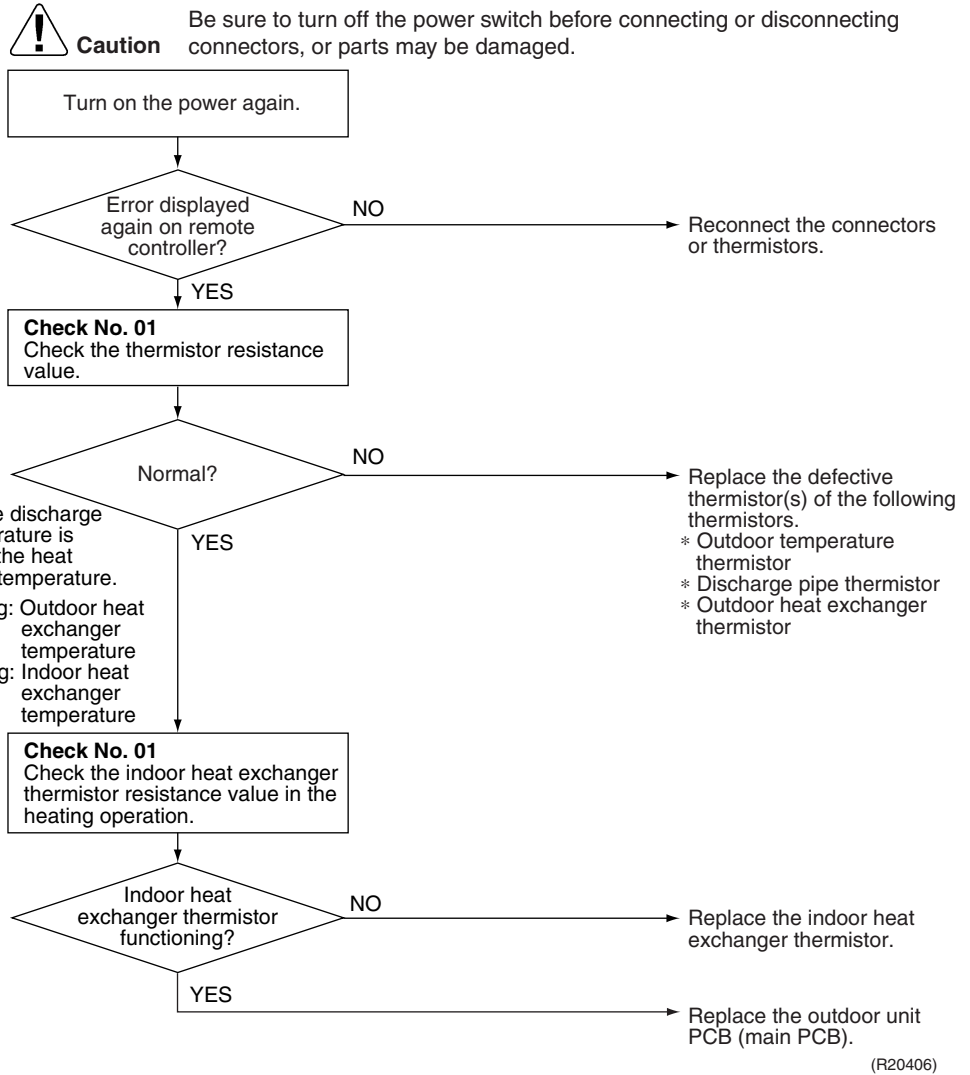

- H3* : Outdoor temperature thermistor
- J3* : Discharge pipe thermistor
- J6* : Outdoor heat exchanger thermistor

 **Note:** When replacing the defective thermistor(s), replace the thermistors as ASSY.

4.23 Electrical Box Temperature Rise

Error Code E3

Method of Error Detection An electrical box temperature rise is detected by checking the radiation fin thermistor with the compressor off.

- Error Decision Conditions**
- With the compressor off, the radiation fin temperature is above **A**.
 - The error is cleared when the radiation fin temperature drops below **B**.
 - To cool the electrical components, the outdoor fan starts when the radiation fin temperature rises above **C** and stops when it drops below **B**.

	A		B		C	
	°C	°F	°C	°F	°C	°F
RK(X)30/36NMVJU	92	197.6	70	158	77	170.6

- Supposed Causes**
- Defective outdoor fan motor
 - Short circuit
 - Defective radiation fin thermistor
 - Disconnection of connector
 - Defective outdoor unit PCB

Troubleshooting

Check No.17
 Refer to P.99

Check No.19
 Refer to P.100

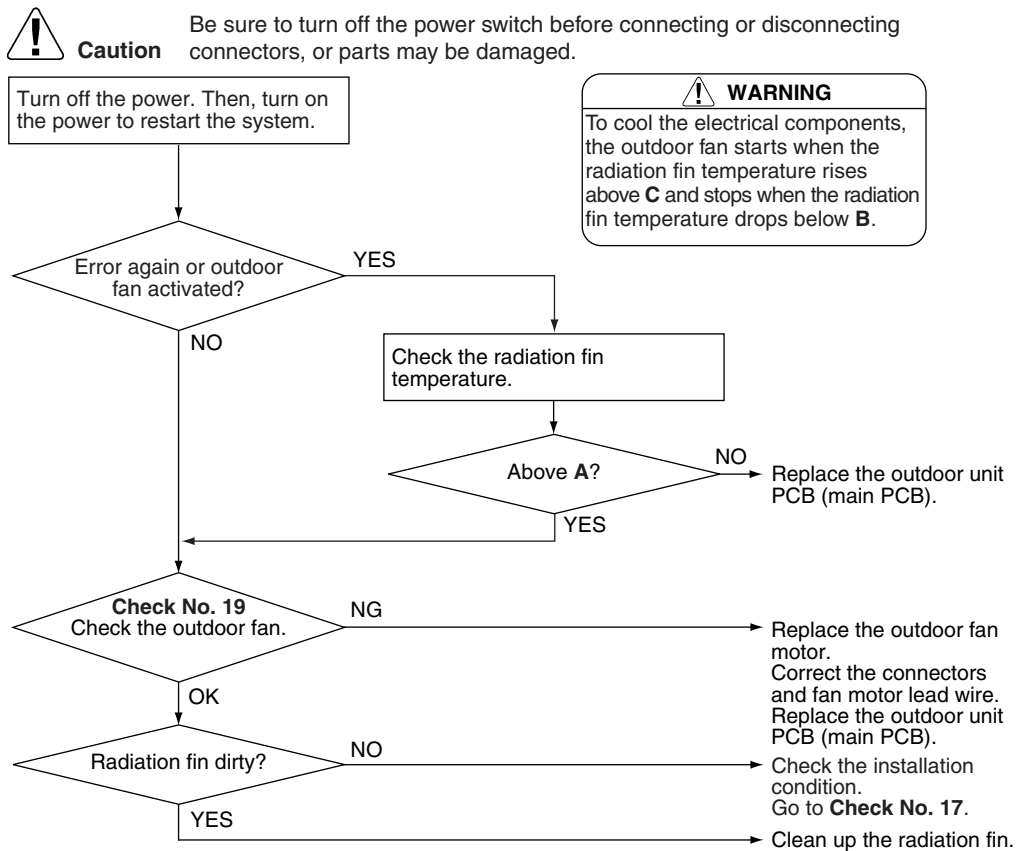

(R22998)

4.24 Radiation Fin Temperature Rise

Error Code L4



Method of Error Detection A radiation fin temperature rise is detected by checking the radiation fin thermistor with the compressor on.

- Error Decision Conditions**
- If the radiation fin temperature with the compressor on is above **A**.
 - The error is cleared when the radiation fin temperature drops below **B**.
 - If the error repeats, the system is shut down.
 - Reset condition: Continuous run for about 60 minutes without any other error

	A		B	
	°C	°F	°C	°F
RK(X)30/36NMVJU	82	179.6	77	170.6

- Supposed Causes**
- Defective outdoor fan motor
 - Short circuit
 - Defective radiation fin thermistor
 - Disconnection of connector
 - Defective outdoor unit PCB
 - Silicone grease not applied properly on the radiation fin after replacing the outdoor unit PCB

Troubleshooting

-  **Check No.17**
Refer to P.99
-  **Check No.19**
Refer to P.100

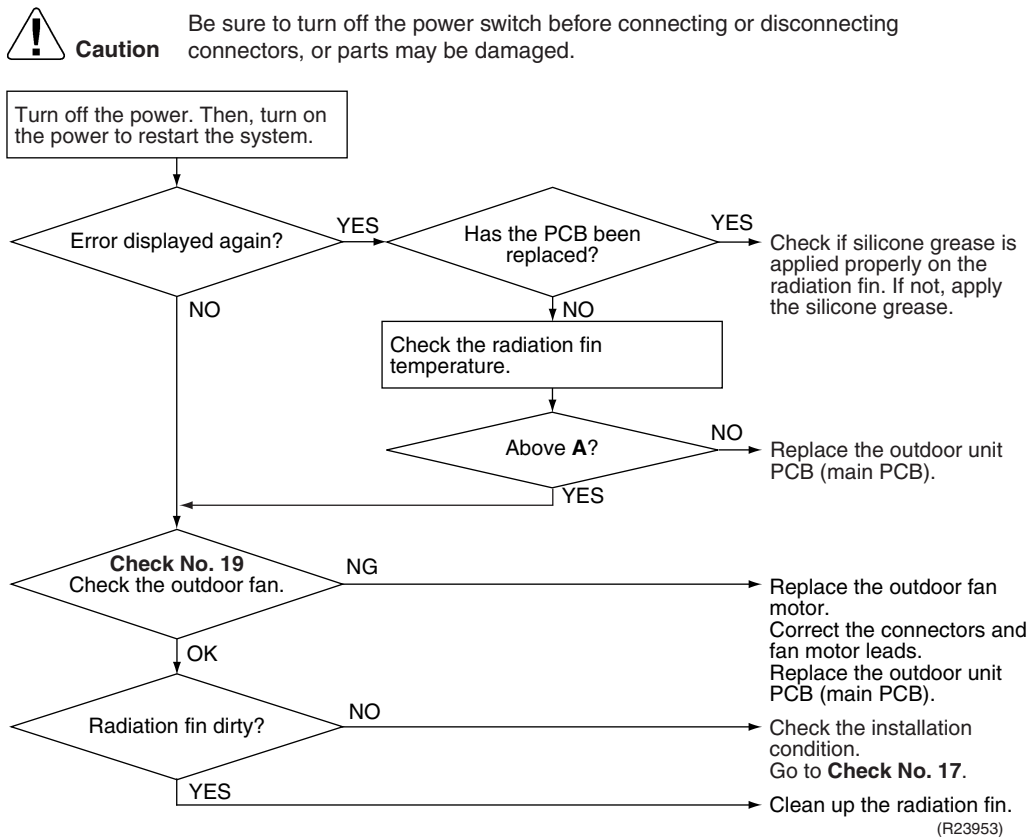

 **Note:** Refer to Silicone Grease on Power Transistor/Diode Bridge on page 111 for details.

4.25 Output Overcurrent Detection

Error Code	L5
Method of Error Detection	An output overcurrent is detected by checking the current that flows in the inverter DC section.
Error Decision Conditions	<ul style="list-style-type: none">■ A position signal error occurs while the compressor is running.■ A rotation speed error occurs while the compressor is running.■ An output overcurrent signal is fed from the output overcurrent detection circuit to the microcomputer.■ If the error repeats, the system is shut down.■ Reset condition: Continuous run for about 11 minutes without any other error
Supposed Causes	<ul style="list-style-type: none">■ Poor installation condition■ Closed stop valve■ Defective power module■ Wrong internal wiring■ Abnormal power supply voltage■ Defective outdoor unit PCB■ Power supply voltage out of specification■ Defective compressor

Troubleshooting



Check No.15
Refer to P.96



Check No.17
Refer to P.99



Check No.18
Refer to P.99



Check No.22
Refer to P.101



Caution Be sure to turn off the power switch before connecting or disconnecting connectors, or parts may be damaged.

* An output overcurrent may result from wrong internal wiring. If the system is interrupted by an output overcurrent after the wires have been disconnected and reconnected for part replacement, check the wiring again.

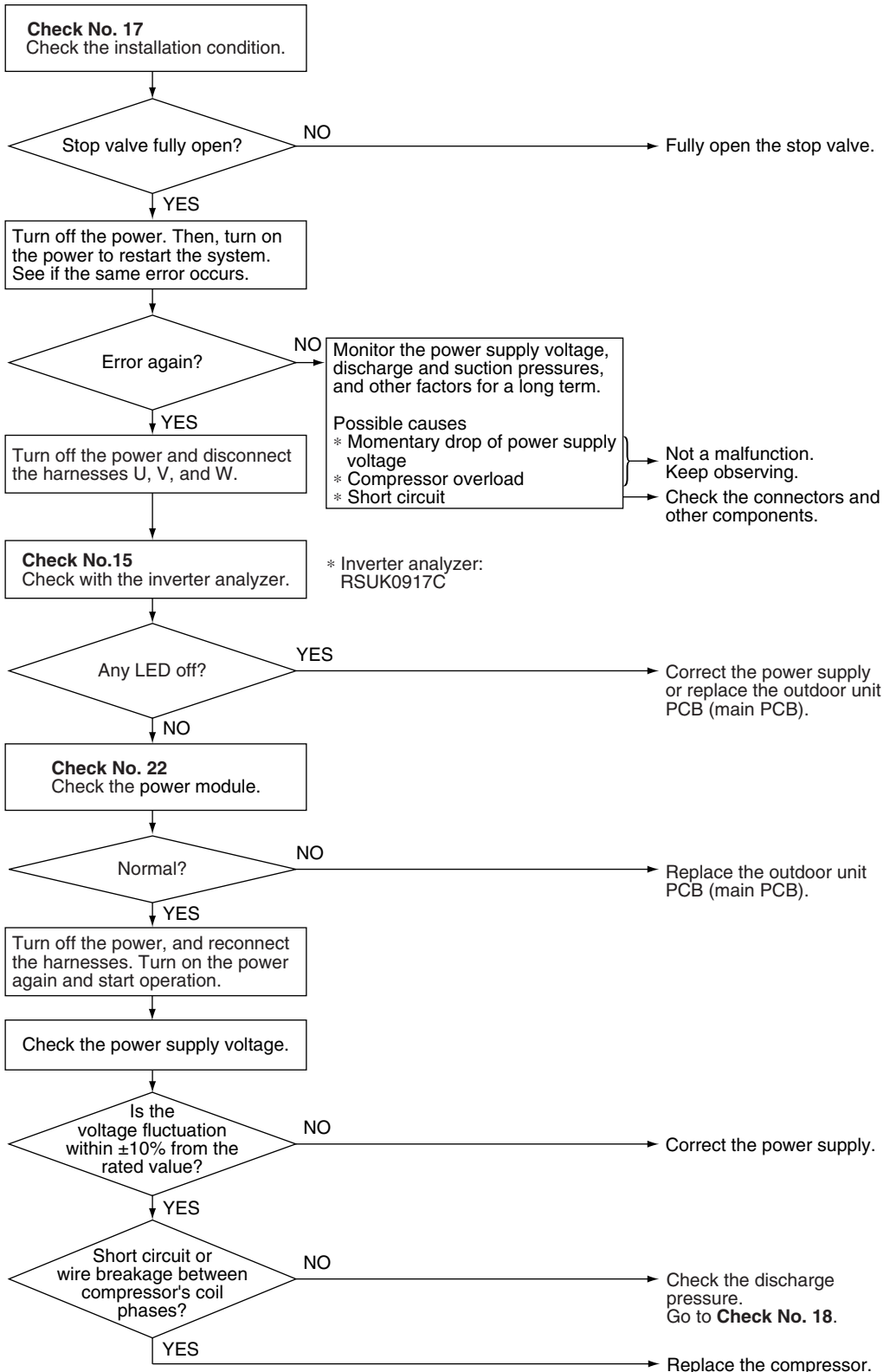

(R22566)

5. Check

5.1 Thermistor Resistance Check

Check No.01

Disconnect the connectors of the thermistors from the PCB, and measure the resistance of each thermistor using a multimeter.

Thermistor temperature		Resistance (kΩ)
°C	°F	
-20	-4	197.8
-15	5	148.2
-10	14	112.1
-5	23	85.60
0	32	65.93
5	41	51.14
10	50	39.99
15	59	31.52
20	68	25.02
25	77	20.00
30	86	16.10
35	95	13.04
40	104	10.62
45	113	8.707
50	122	7.176

(R25°C (77°F) = 20 kΩ, B = 3950 K)

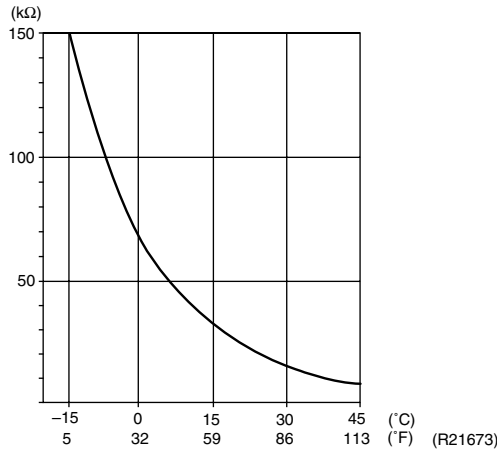

Room temperature thermistor

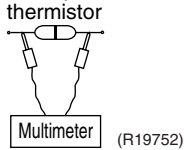

Other thermistors

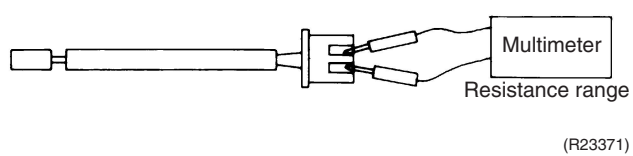

- The room temperature thermistor is soldered on the PCB. Disconnect the connector to the control PCB before measuring the resistance.
- When the connector of indoor heat exchanger thermistor is soldered on the PCB, remove the thermistor and measure the resistance.

5.2 Indoor Fan Motor Connector Output Check

Check No.02

1. Check the connection of connector.
2. Check the motor power supply voltage output (pins 4 - 7).
3. Check the motor control voltage (pins 4 - 3).
4. Check the rotation command voltage (pins 4 - 2).
5. Check the rotation pulse (pins 4 - 1).

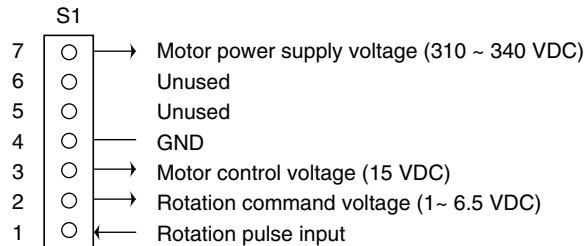

(R19654)

5.3 Power Supply Waveforms Check

Check No.11

Measure the power supply waveform between No. 1 and No. 2 on the terminal board, and check the waveform disturbance.

- Check if the power supply waveform is a sine wave (Fig.1).
- Check if there is waveform disturbance near the zero-cross (sections circled in Fig.2).

Fig.1

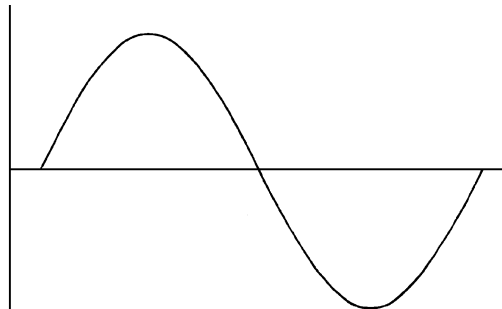

(R1736)

Fig.2

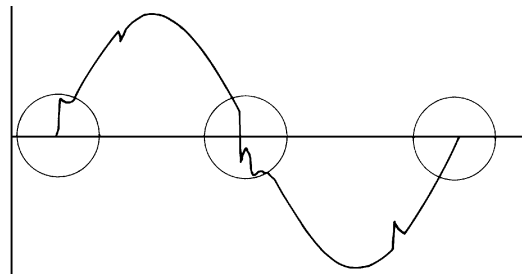

(R1444)

5.4 Electronic Expansion Valve Check

Check No.12

Conduct the following to check the electronic expansion valve (EV).

1. Check if the EV connector is correctly connected to the PCB.
2. Turn the power off and on again, and check to see if the EV generates a latching sound.
3. If the EV does not generate a latching sound in the above step 2, disconnect the connector and check the continuity using a multimeter.
4. Check the continuity between the pins 5 - 1, 5 - 2, 5 - 3, 5 - 4. If there is no continuity between the pins, the EV coil is faulty.
5. If the continuity is confirmed in step 3, the outdoor unit PCB (main PCB) is faulty.

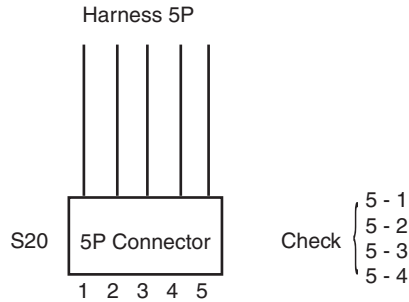

(R23840)

5.5 Four Way Valve Performance Check

Check No.13

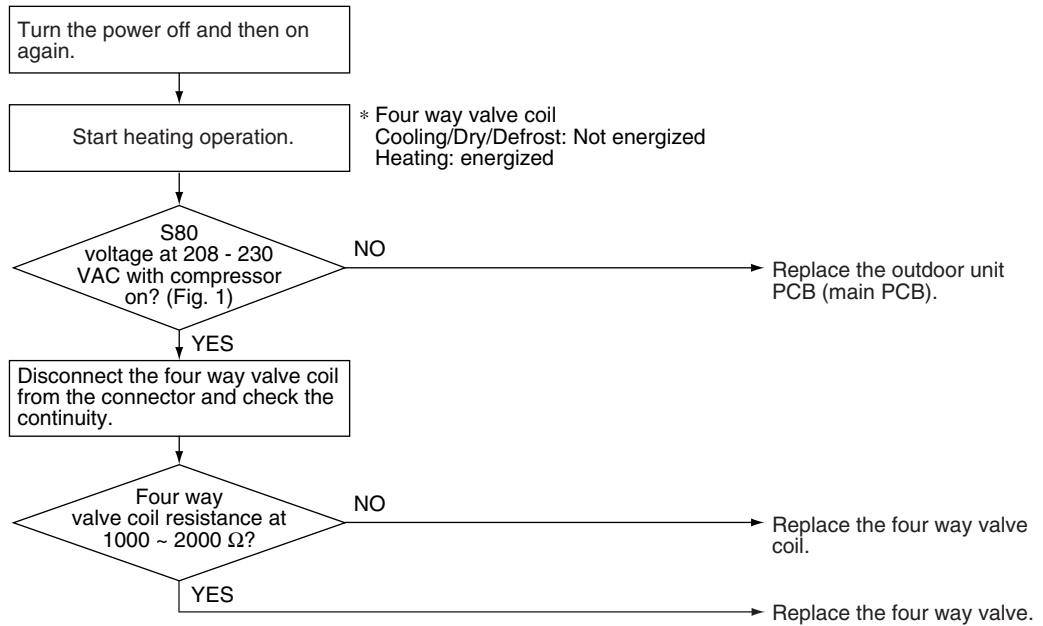

(R21674)

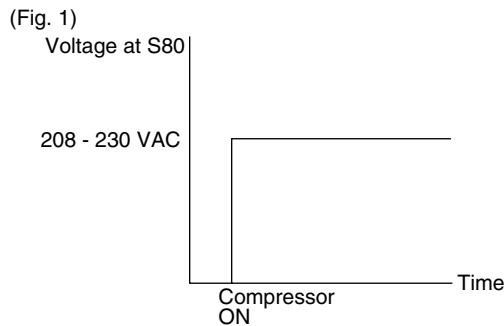

(R14674)

5.6 Inverter Unit Refrigerant System Check

Check No.14

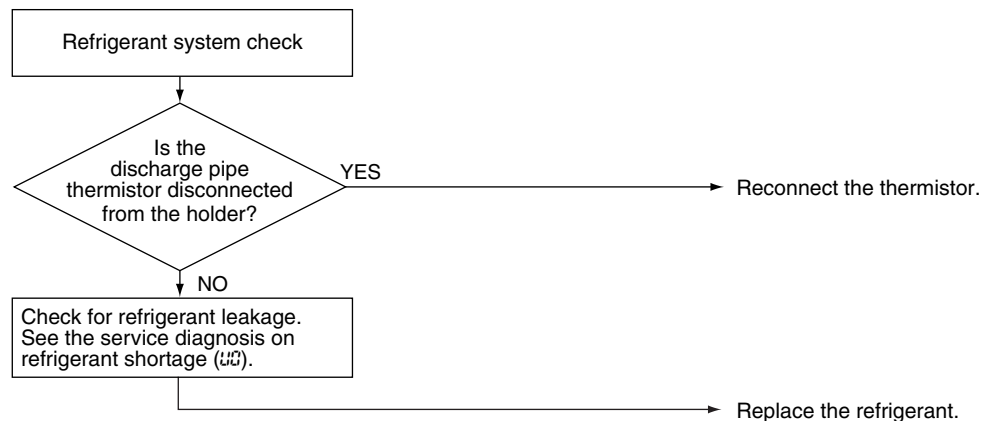

(R15833)

5.7 Inverter Analyzer Check

Check No.15

■ Characteristics

Inverter analyzer: RSUK0917C

If an abnormal stop occurs due to compressor startup failure or overcurrent output when using an inverter unit, it is difficult to judge whether the stop is caused by the compressor failure or some other failure (main PCB, power module, etc.). The inverter analyzer makes it possible to judge the cause of trouble easily and securely. (Connect an inverter analyzer as a quasi-compressor instead of compressor and check the output of the inverter.)

■ Operation Method

Step 1

Be sure to turn off the power.

Step 2

Install an inverter analyzer instead of a compressor.

Note:

Make sure the charged voltage of the built-in smoothing electrolytic capacitor drops to 10 VDC or below before carrying out the service work.

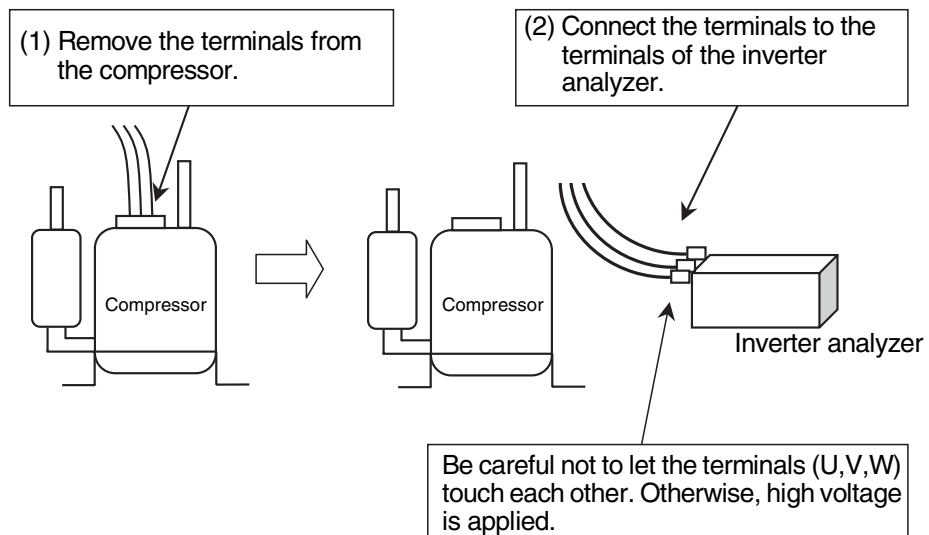

(R22731)

Reference:

If the terminals of the compressor are not FASTON terminals (difficult to remove the wire on the terminals), it is possible to connect wires available on site to the outdoor unit from output side of PCB. (Do not connect them to the compressor at the same time, otherwise it may result in incorrect detection.)

Step 3

Activate power transistor test operation from the indoor unit.

- (1) Turn the power on.
- (2) Select FAN operation with the **Mode** button on the remote controller.
- (3) Press the center of the **Temp** button and the **Mode** button at the same time.
- (4) Select ? with the **Temp ▲** or **Temp ▼** button.
- (5) Press the **Mode** button to start the power transistor test operation.

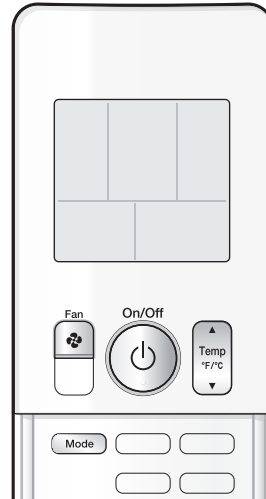

(R24537)

■ **Diagnose method (Diagnose according to 6 LEDs lighting status of inverter analyzer.)**

- (1) If all the LEDs are lit uniformly, the compressor is defective.
→ Replace the compressor.
- (2) If the LEDs are not lit uniformly, check the power module.
→ Refer to **Check No.22**.
- (3) If NG in **Check No.22**, replace the power module.
(Replace the main PCB. The power module is united with the main PCB.)
If OK in **Check No.22**, check if there is any solder cracking on the PCB.
- (4) If any solder cracking is found, replace the PCB or repair the soldered section.
If there is no solder cracking, replace the PCB.

**Caution**

- (1) When the output frequency is low, the LEDs blink slowly. As the output frequency increases, the LEDs blink quicker. (The LEDs look like they are lit.)
- (2) On completion of the inverter analyzer diagnosis, be sure to re-crimp the FASTON terminals. Otherwise, the terminals may be burned due to loosening.

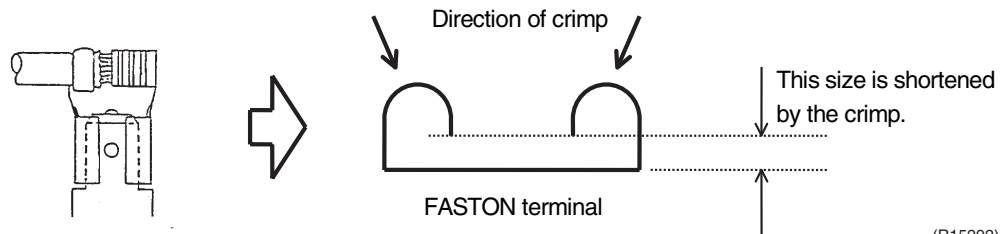

(R15292)

5.8 Rotation Pulse Check on the Outdoor Unit PCB

Check No.16

Make sure that the voltage of $320 + 100 \text{ V} \sim 320 - 50 \text{ V}$ is applied.

1. Set operation off and power off. Disconnect the connector S70 or S71.
2. Check that the voltage between the pins 4 - 7 is 320 VDC.
3. Check that the control voltage between the pins 4 - 3 is 15 VDC.
4. Check that the rotation command voltage between the pins 4 - 2 is 0 ~ 6.5 VDC.
5. Keep operation off and power off. Connect the connector S70 or S71.
6. Check whether 4 rotation pulses (0 ~ 15 VDC) are input at the pins 4 - 1 when the fan motor is rotated 1 turn by hand.

When the fuse is melted, check the outdoor fan motor for proper function.

If NG in step 2 → Defective PCB → Replace the outdoor unit PCB (main PCB).

If NG in step 4 → Defective Hall IC → Replace the outdoor fan motor.

If OK in both steps 2 and 4 → Replace the outdoor unit PCB (main PCB).

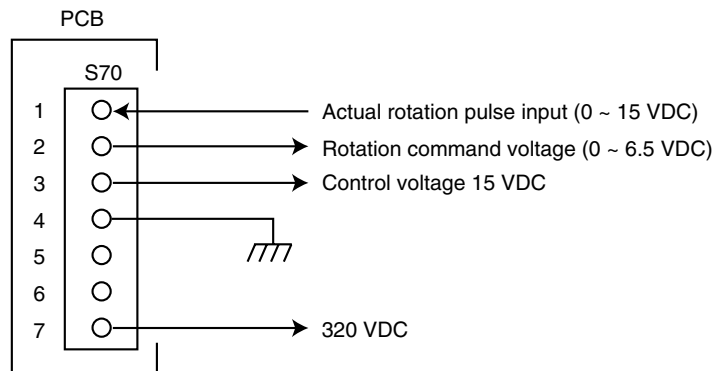

(R19655)

5.9 Installation Condition Check

Check No.17

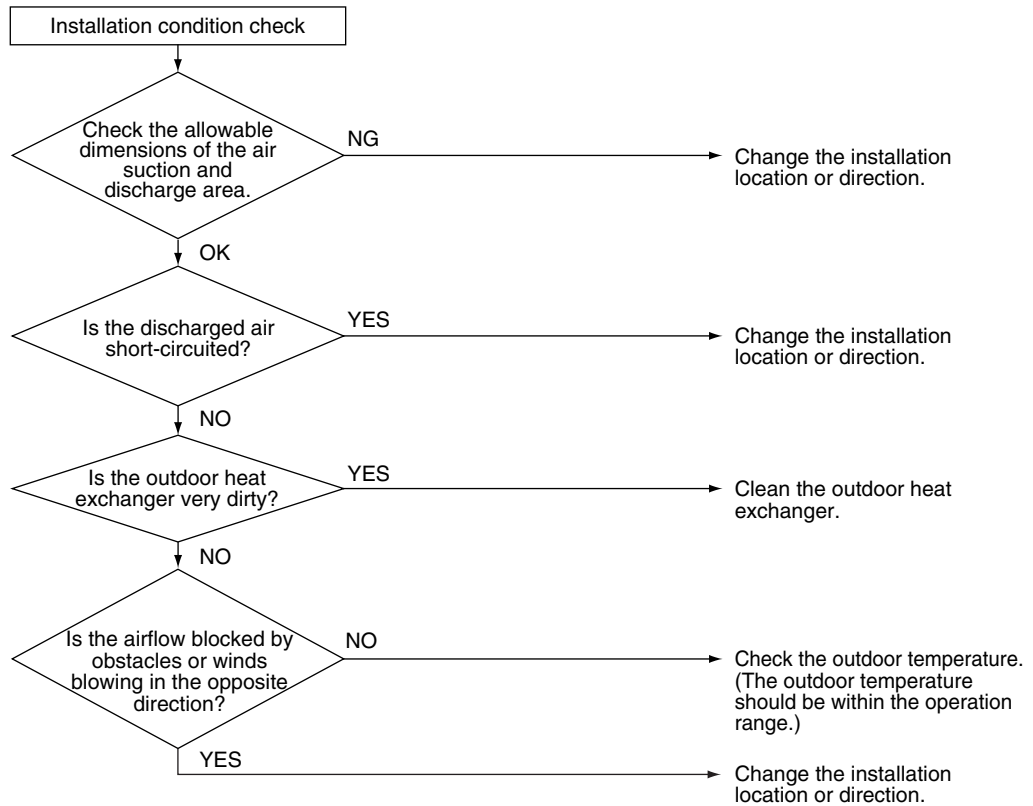

(R19394)

5.10 Discharge Pressure Check

Check No.18

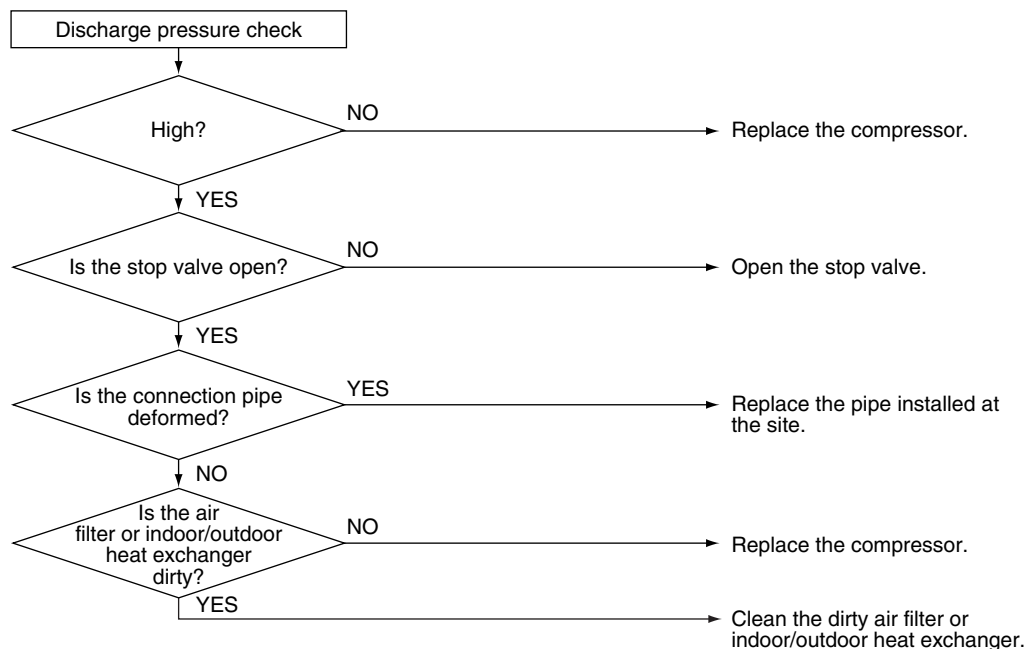

(R19385)

5.11 Outdoor Fan System Check

Check No.19

DC motor

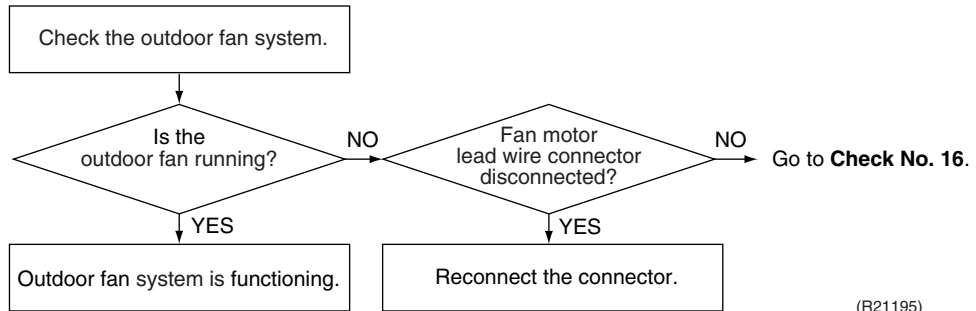

(R21195)

5.12 Main Circuit Short Check

Check No.20

Check to make sure that the voltage between (+) and (-) of the diode bridge (DB1) is approximately 0 V before checking.

- Measure the resistance between the pins of the DB1 referring to the table below.
- If the resistance is ∞ or less than 1 k Ω , short circuit occurs on the main circuit.

Positive terminal (+) of digital multimeter	~ (2, 3)	+ (4)	~ (2, 3)	- (1)
Negative terminal (-) of digital multimeter	+ (4)	~ (2, 3)	- (1)	~ (2, 3)
Resistance is OK.	several k Ω ~ several M Ω			
Resistance is NG.	0 Ω or ∞			

RK(X)30/36NMVJU

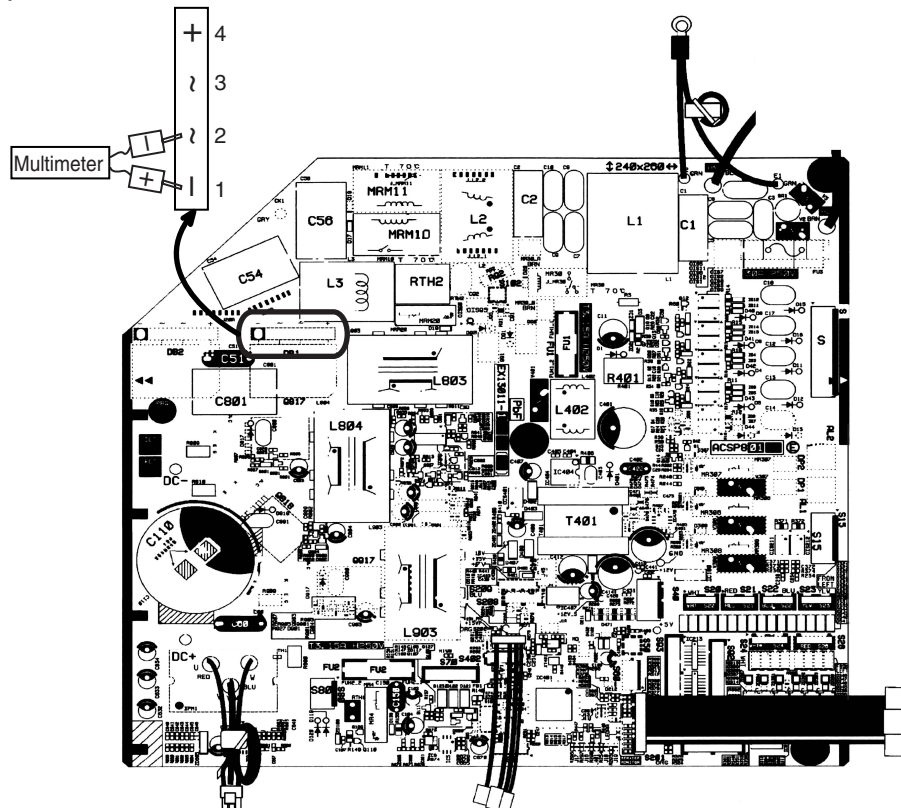

(R24538)

5.13 Capacitor Voltage Check

Check No.21

Before this check, be sure to check the main circuit for short circuit.
 With the circuit breaker still on, measure the voltage according to the drawing of the model in question. Be careful never to touch any live parts.

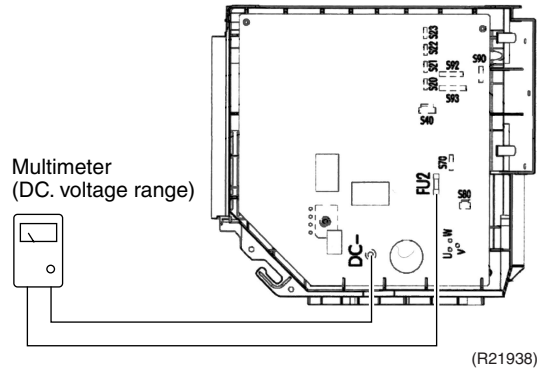

- To prevent an electrical shock, use a multimeter to check that the voltage between FU2 and DC- is 50 V or less.
- The surface of the test points (DC-) may be covered with the coating. Be sure to make firm contact between the multimeter probes and the test points.

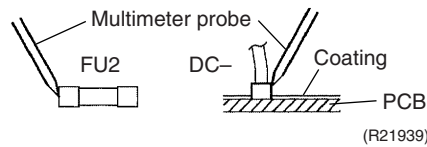

5.14 Power Module Check

Check No.22

Check to make sure that the voltage between (+) and (-) of the power module is approximately 0 V before checking.

- Disconnect the compressor harness connector from the outdoor unit PCB. To disengage the connector, press the protrusion on the connector.
- Follow the procedure below to measure resistance between the terminals of the power module and the terminals of the compressor with a multimeter. Evaluate the measurement results referring to the following table.

Positive terminal (+) of digital multimeter	Power module (+)	UVW	Power module (-)	UVW
Negative terminal (-) of digital multimeter	UVW	Power module (+)	UVW	Power module (-)
Resistance is OK.	several kΩ ~ several MΩ			
Resistance is NG.	0 Ω or ∞			

RK(X)30/36NMVJU

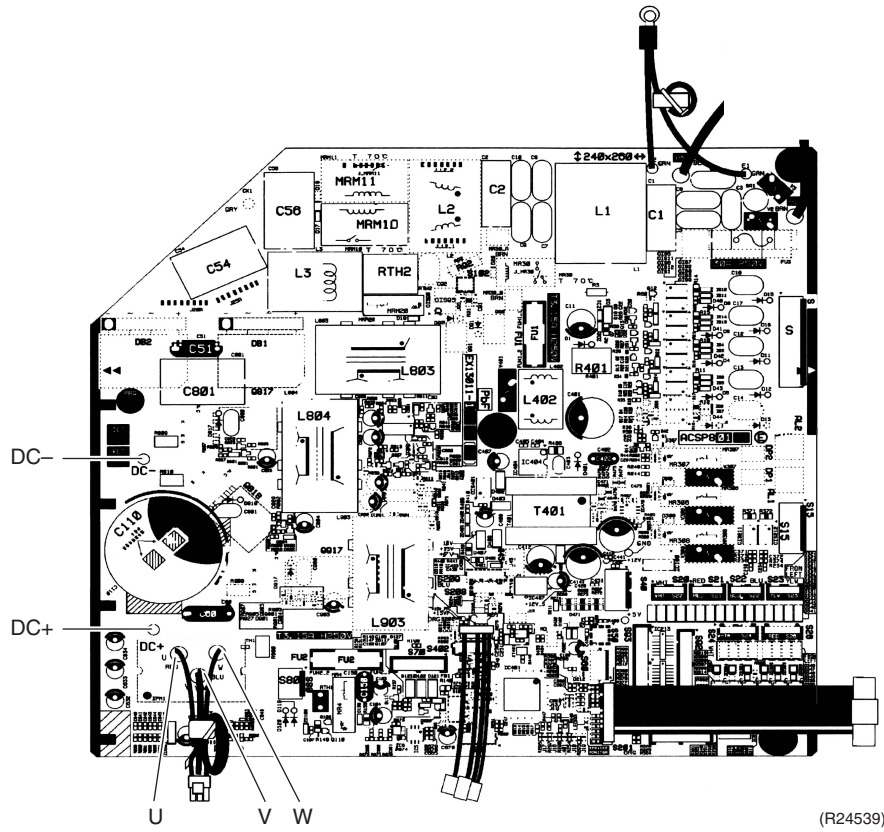

(R24539)

Part 7

Trial Operation and Field Settings

1. Pump Down Operation	104
2. Forced Cooling Operation	105
3. Trial Operation	106
4. Field Settings	107
4.1 Model Type Setting	107
4.2 Temperature Display Switch	107
4.3 When 2 Units are Installed in 1 Room	108
4.4 Facility Setting Switch (cooling at low outdoor temperature).....	109
5. Silicone Grease on Power Transistor/Diode Bridge	111

1. Pump Down Operation

Outline

In order to protect the environment, be sure to conduct pump down operation when relocating or disposing of the unit.

Details

1. Remove the valve caps from the liquid stop valve and the gas stop valve.
2. Carry out forced cooling operation.
3. After 5 to 10 minutes, close the liquid stop valve with a hexagonal wrench.
4. After 2 to 3 minutes, close the gas stop valve and stop the forced cooling operation.
5. Attach the valve cap once procedures are complete.

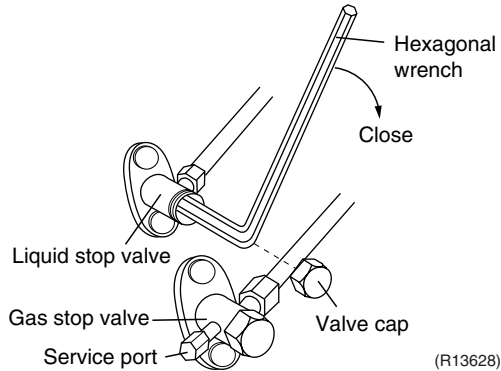

Refer to forced cooling operation on page 105.

2. Forced Cooling Operation

Outline

The forced cooling operation is allowed when both the following conditions are met.

- 1) The outdoor unit is not abnormal and not in the 3-minute standby mode.
- 2) The outdoor unit is not operating.

Protection functions have priority over all other functions during forced cooling operation.

Procedure

■ With the indoor unit ON/OFF button

Press the indoor unit **ON/OFF** button for at least 5 seconds. (The operation will start.)

- ◆ Forced cooling operation will stop automatically after about 15 minutes.
To stop the operation, press the indoor unit **ON/OFF** button.

■ With the indoor unit's remote controller

- (1) Press **Mode** button and select the cooling operation.
- (2) Press **On/Off** button to turn on the system.
- (3) Press **Temp ▲, ▼** buttons and **Mode** button at the same time.
- (4) Press **Temp ▲, ▼** buttons, select “ 7 ”, and press **Mode** button for confirmation.
 - ◆ Forced cooling operation will stop automatically after about 30 minutes.
To stop the operation, press **On/Off** button.

Indoor Unit

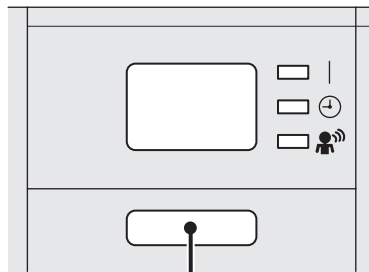

Indoor unit **ON/OFF** button

(R24540)

Remote Controller

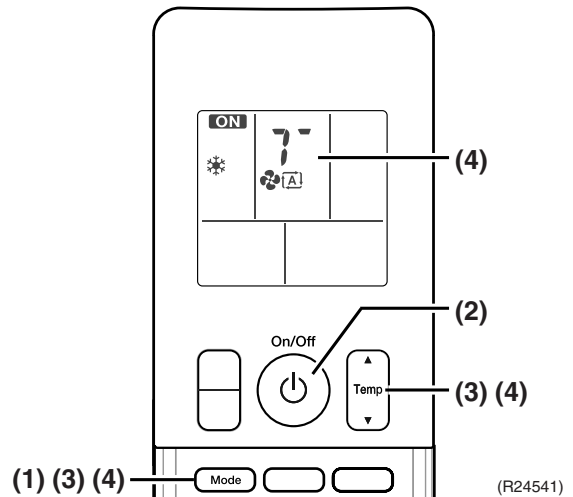

(R24541)

3. Trial Operation

Outline

1. Measure the supply voltage and make sure that it is within the specified range.
2. In cooling operation, select the lowest programmable temperature;
in heating operation, select the highest programmable temperature.
3. Carry out the trial operation following the instructions in the operation manual to ensure that all functions and parts, such as the movement of the flaps, are working properly.
 - ♦ To protect the air conditioner, restart operation is disabled for 3 minutes after the system has been turned off.
4. After trial operation is complete, set the temperature to a normal level (78°F to 82°F (26°C to 28°C) in cooling operation, 68°F to 75°F (20°C to 24°C) in heating operation).

Procedure

When operating the air conditioner in cooling operation in winter, or heating operation in summer, set it to the trial operation mode using the following method.

With remote controller

- (1) Press **On/Off** button to turn on the system.
- (2) Press the center of **Temp** button and **Mode** button at the same time.
- (3) Select “ 7 ” (trial operation) with **Temp ▲** or **Temp ▼** button.
- (4) Press **Mode** button to start the trial operation.
- (5) Press **Mode** button and select operation mode.
- (6) Trial operation will stop automatically after about 30 minutes.
To stop trial operation, press **On/Off** button.

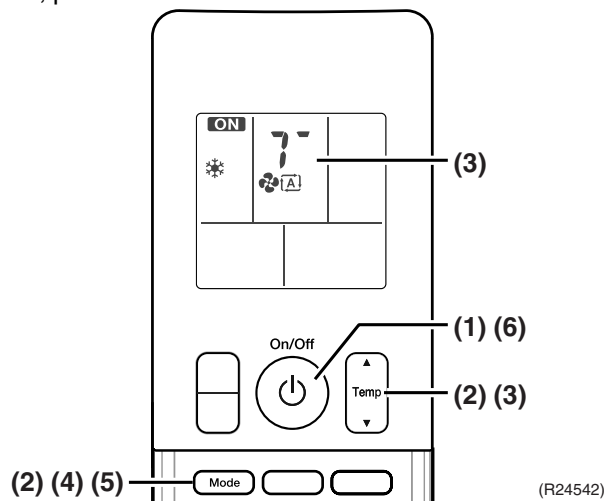

Test Items

Test items	Symptom
Indoor and outdoor units are installed securely.	Fall, vibration, noise
No refrigerant gas leaks.	Incomplete cooling/heating function
Refrigerant gas and liquid pipes and indoor drain hose extension are thermally insulated.	Water leakage
Draining line is properly installed.	Water leakage
System is properly grounded.	Electrical leakage
Only specified wires are used for all wiring, and all wires are connected correctly.	No operation or burn damage
Indoor or outdoor unit's air inlet or air outlet are unobstructed.	Incomplete cooling/heating function
Stop valves are opened.	Incomplete cooling/heating function
Indoor unit properly receives remote controller commands.	No operation
Remote controller jumper setting is correct for the type of unit (heat pump or cooling only).	Remote controller malfunctioning

4. Field Settings

4.1 Model Type Setting

- (1) Turn on all the fluorescent lamps in the room, if any, and find a location where the remote controller signals are properly received by the indoor unit (within 23ft (7m)).
- (2) Configure according to the type of unit (heat pump or cooling only). The default setting is heat pump.
 - ◆ **For heat pump (outdoor unit model: RX)**
No change to jumper setting is required.
 - ◆ **For cooling only (outdoor unit model: RK)**
Cut the jumper J8 inside the remote controller.

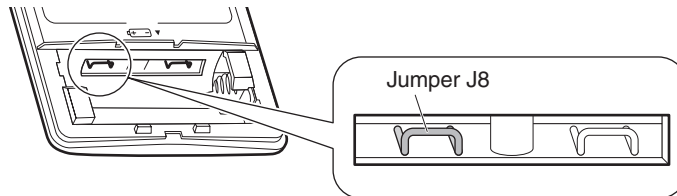

(R24543)

4.2 Temperature Display Switch

- Press the upper side of **Temp** button and **On** button at the same time for 5 seconds to change the unit of temperature display.

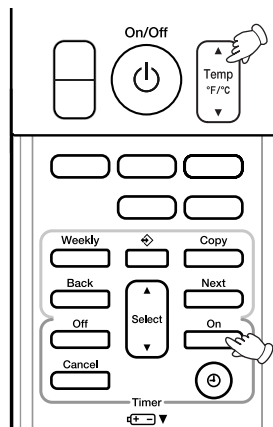

(R24544)

4.3 When 2 Units are Installed in 1 Room

Outline

When 2 indoor units are installed in 1 room, 1 of the 2 indoor units and the corresponding wireless remote controller can be set for different addresses.
Both the indoor unit PCB and the wireless remote controller need alteration.

Indoor Unit PCB

- Cut the address setting jumper JA on the control PCB.

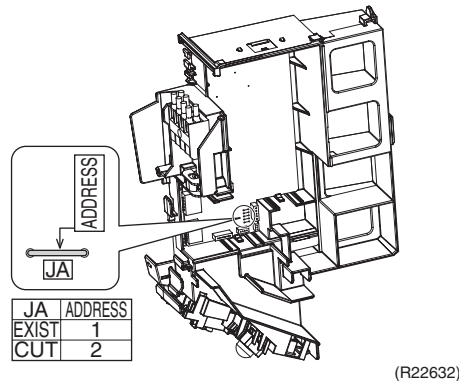

Caution

Replace the PCB if you accidentally cut a wrong jumper.

Jumpers are necessary for electronic circuit. Improper operation may occur if you cut any of them.

Wireless Remote Controller

ARC466 series

- Cut the address setting jumper (J4).

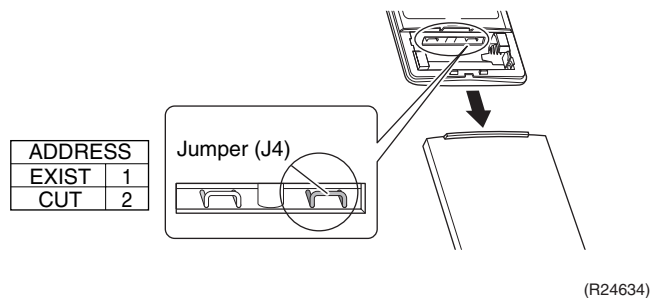

Caution

Replace the remote controller if you cut a wrong jumper.

The heating operation will not be available when the jumper on the left side is cut.

4.3.1 Jumper Settings

Jumper (on indoor unit PCB)	Function	When connected (factory setting)	When cut
JB	Fan speed setting when compressor stops for thermostat OFF. (effective only at cooling operation)	Fan speed setting; Remote controller setting	The fan stops.
JC	Power failure recovery function	Auto-restart	The unit does not resume operation after recovering from a power failure. Timer settings are cleared.



For the location of the jumpers, refer to page 7.

4.4 Facility Setting Switch (cooling at low outdoor temperature)

Outline

This function is designed for facilities such as equipment or computer rooms. It is never to be used in a residence or office where people occupy the space.

Details

(1) Turning on SW5-3 on the PCB will extend the operation range to -10°C (14°F). Installing an air direction adjustment grille (sold separately) will further extend the operation range to -20°C (-4°F). In these cases, the unit will stop operating if the outdoor temperature falls below -20°C (-4°F), restarting once the temperature rises above this level.

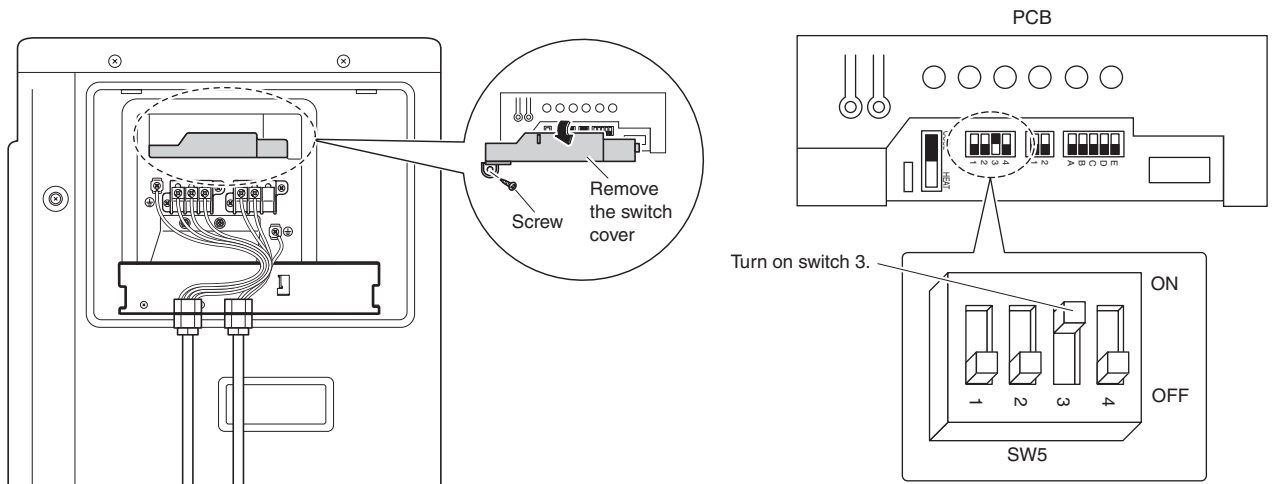

(R24546)

(2) Only for cooling models

If the unit is to be operated in outdoor temperatures down to -30°C (-22°F), turn on SW6-2 on the PCB, in addition to the settings in step (1) above. If the outdoor temperature falls below -30°C (-22°F) the unit will stop operating and will only restart once the temperature rises above -30°C (-22°F).

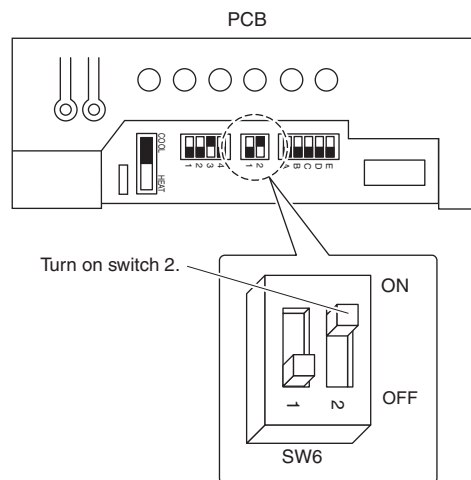

(R24547)

**Caution**

- If the outdoor unit is installed where the outdoor heat exchanger of the unit is exposed to direct wind, provide a windbreak wall.
- Intermittent noises may be produced by the indoor unit due to the outdoor fan turning on and off when using facility settings.
- Do not place humidifiers or other items which might raise the humidity in rooms where facility settings are being used.
A humidifier might cause dew jumping from the indoor unit outlet vent.
- Activating the facility setting sets the indoor fan tap to the highest position.
Notify the user about this.
- When the outdoor temperature is below -20°C (-4°F) and if SW6-2 in step 2) below is turned on, for the purpose of protecting the compressor, it may take up to 3 hours for operation to begin while the system warms up.

5. Silicone Grease on Power Transistor/Diode Bridge

Outline

Apply the specified silicone grease to the heat radiation part of a power transistor/diode bridge when you replace an outdoor unit PCB. The silicone grease encourages the heat radiation of a power transistor/diode bridge.

Details

1. Wipe off the old silicone grease completely.
2. Apply the silicone grease evenly. See the illustrations below for examples of application.
3. Tighten the screws of the power transistor/diode bridge.
4. Make sure that the heat radiation parts are firmly contacted to the radiation fin.

Note: Smoke emission may be caused by bad heat radiation when the silicone grease is not appropriately applied.

- OK: Evenly applied

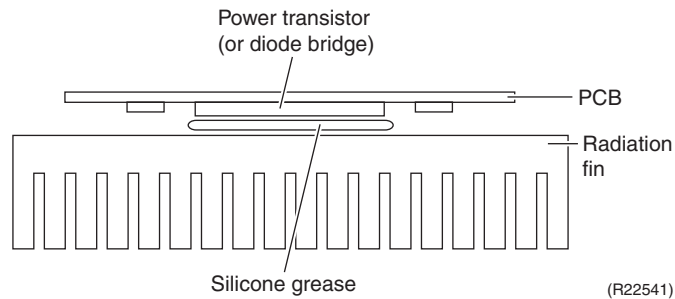

- NG: Not evenly applied

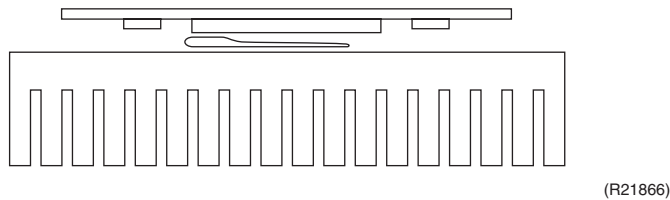

- NG: Foreign matter is stuck.

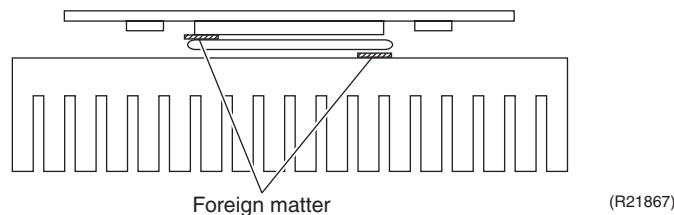

Part 8

Appendix

1. Piping Diagrams.....	113
1.1 Indoor unit	113
1.2 Outdoor Unit.....	114
2. Wiring Diagrams.....	115
2.1 Indoor Unit.....	115
2.2 Outdoor Unit.....	116
3. Operation Limit.....	117

1. Piping Diagrams

1.1 Indoor unit

FTX30/36NVJU

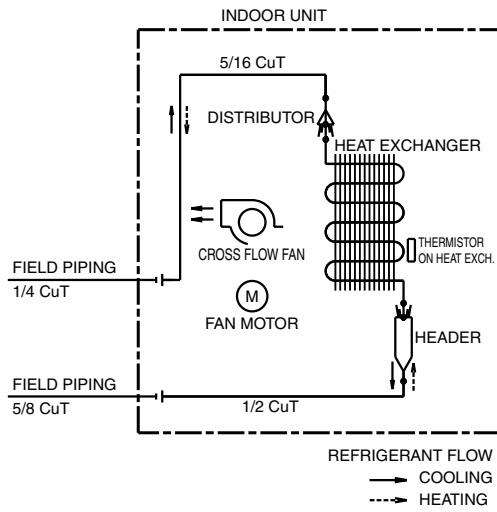

4D107870

1.2 Outdoor Unit

1.2.1 Cooling Only

RK30/36NMVJU

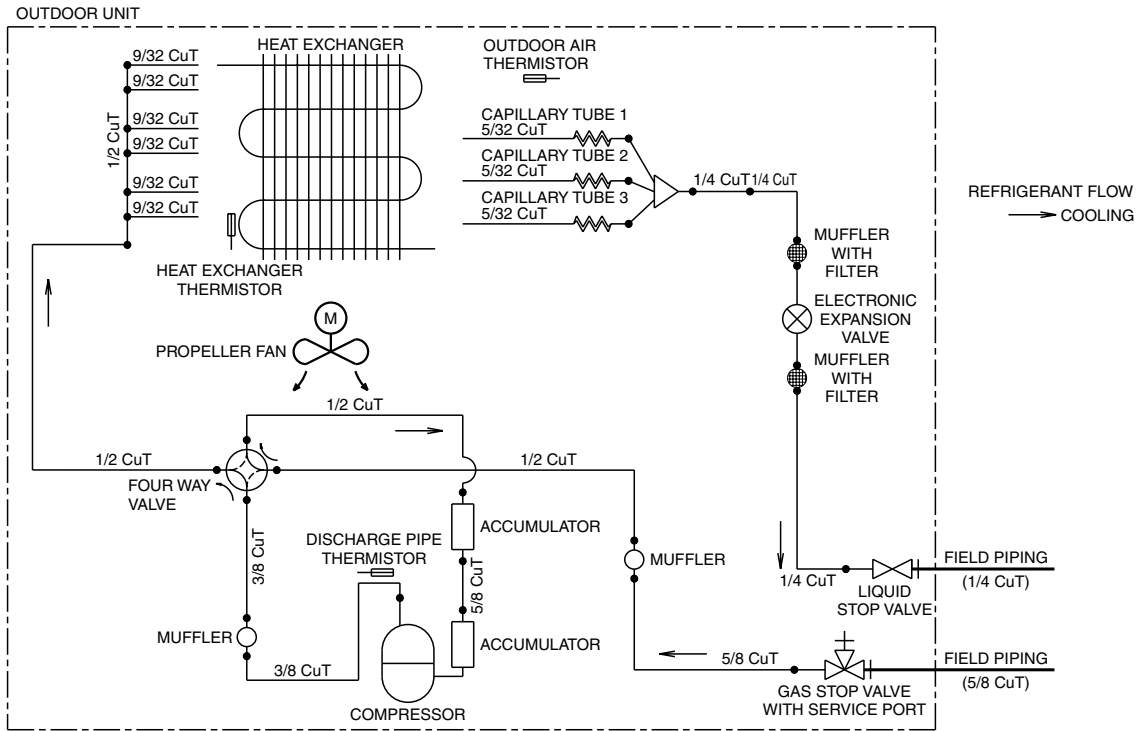

3D107986

1.2.2 Heat Pump

RX30/36NMVJU

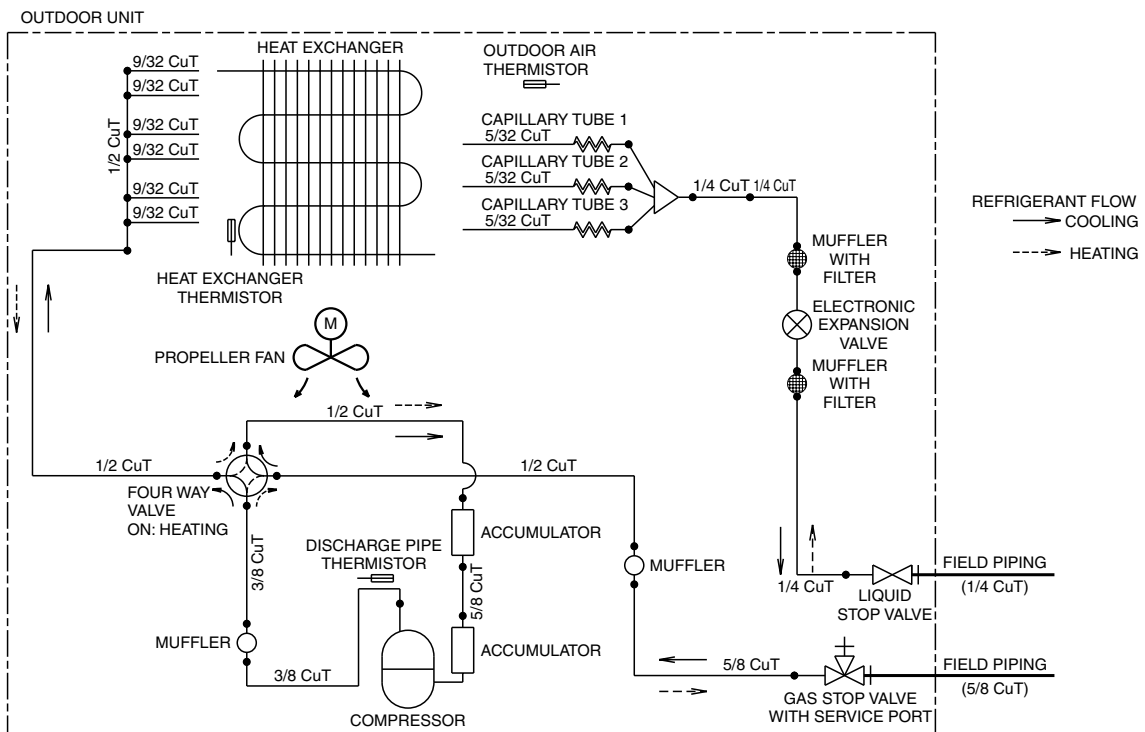

3D107985

2. Wiring Diagrams

2.1 Indoor Unit

FTX30/36NVJU

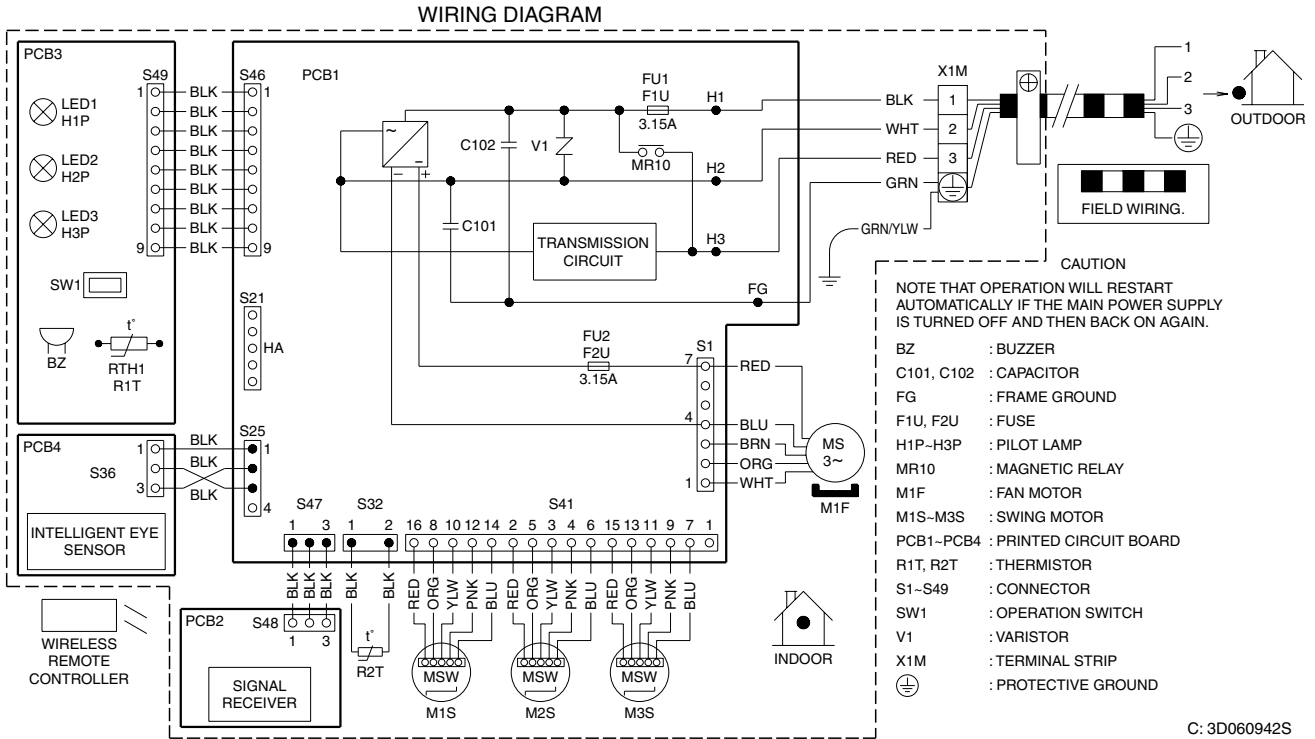

Note: PCB1: Control PCB
 PCB2: Signal receiver PCB
 PCB3: Display PCB
 PCB4: INTELLIGENT EYE sensor PCB
 Refer to Part 3 for Printed Circuit Board Connector Wiring Diagram.

2.2 Outdoor Unit

RK(X)30/36NMVJU

WIRING DIAGRAM

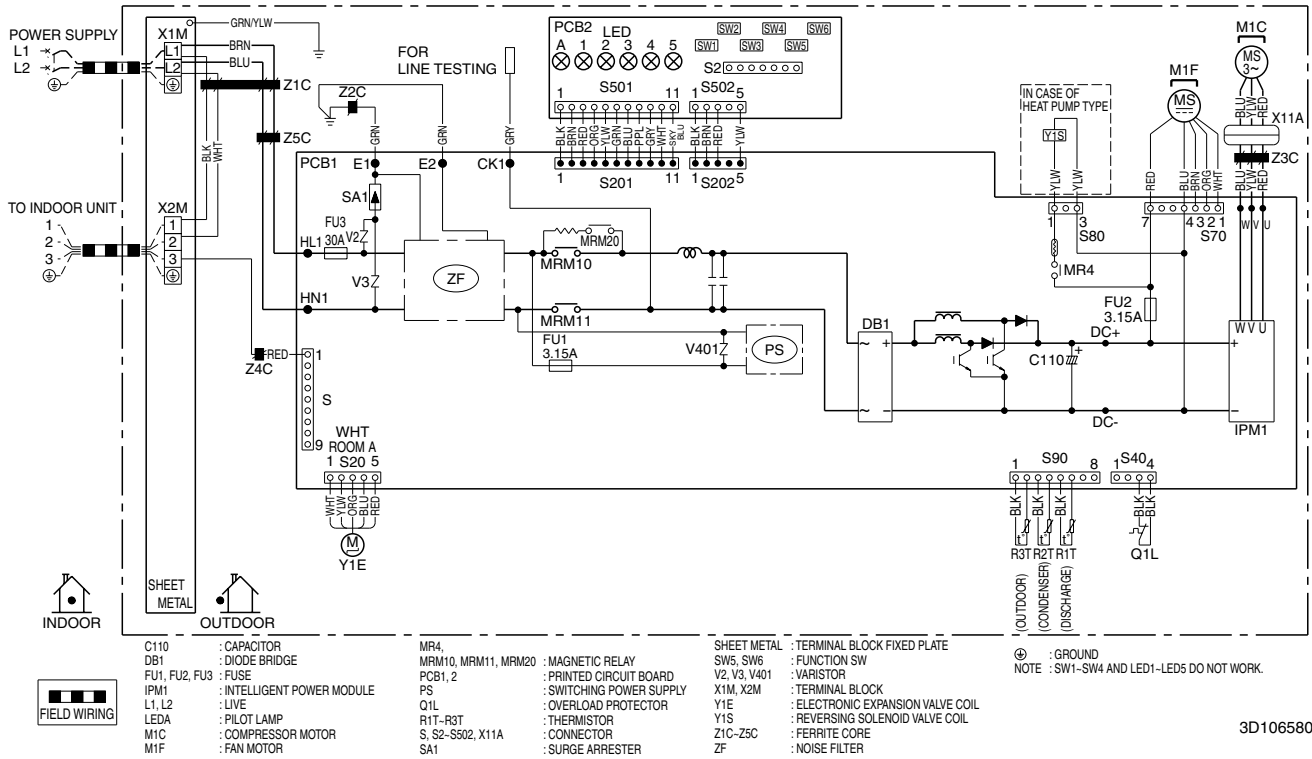

3D106580



Note: PCB1: Main PCB
 PCB2: Service monitor PCB
 Refer to Part 3 for Printed Circuit Board Connector Wiring Diagram.

3. Operation Limit

RK30/36NMVJU

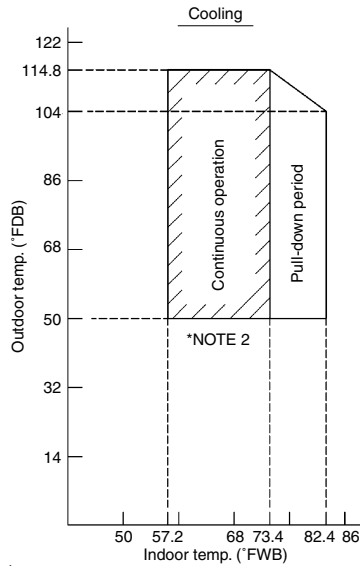

Notes:

- The graphs are based on the following conditions.
 - Equivalent piping length 25ft
 - Level difference 0ft
 - Airflow rate High
- Facility Setting (cooling at low outdoor temperature)
 This function is limited only for facilities (the target of air conditioning is equipment such as computer).
 Never use it in a residence or office (the space where is a human).
 Refer to the installation manual in detail of setting.

4D108219

RX30/36NMVJU

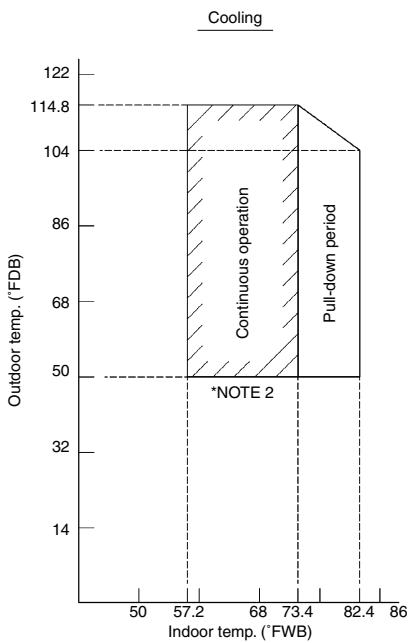

Notes:

- The graphs are based on the following conditions.
 - Equivalent piping length 25ft
 - Level difference 0ft
 - Airflow rate High

- Facility Setting (cooling at low outdoor temperature)
 This function is limited only for facilities (the target of air conditioning is equipment such as computer).
 Never use it in a residence or office (the space where is a human).
 Refer to the installation manual in detail of setting.

3D108218

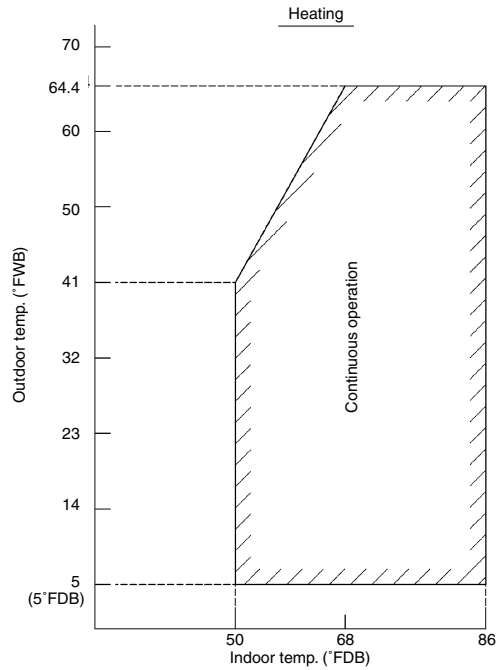

Revision History

Month / Year	Version	Revised contents
03 / 2017	SiUS041638E	First edition

Warning



- Daikin products are manufactured for export to numerous countries throughout the world. Prior to purchase, please confirm with your local authorized importer, distributor and/or retailer whether this product conforms to the applicable standards, and is suitable for use, in the region where the product will be used. This statement does not purport to exclude, restrict or modify the application of any local legislation.
- Ask a qualified installer or contractor to install this product. Do not try to install the product yourself. Improper installation can result in water or refrigerant leakage, electrical shock, fire or explosion.
- Use only those parts and accessories supplied or specified by Daikin. Ask a qualified installer or contractor to install those parts and accessories. Use of unauthorized parts and accessories or improper installation of parts and accessories can result in water or refrigerant leakage, electrical shock, fire or explosion.
- Read the user's manual carefully before using this product. The user's manual provides important safety instructions and warnings. Be sure to follow these instructions and warnings.

If you have any inquiries, please contact your local importer, distributor and/or retailer.

Cautions on product corrosion

1. Air conditioners should not be installed in areas where corrosive gases, such as acid gas or alkaline gas, are produced.
2. If the outdoor unit is to be installed close to the sea shore, direct exposure to the sea breeze should be avoided. If you need to install the outdoor unit close to the sea shore, contact your local distributor.

Dealer

© All rights reserved

● Specifications, designs and other content appearing in this brochure are current as of March 2017 but subject to change without notice.