

DAIKIN ROOM AIR CONDITIONER

OPERATION MANUAL

INVERTER

English

Français

Español



MODELS

FTXS30HVJU
FTXS36HVJU
FTXS30LVJU
FTXS36LVJU

CONTENTS

READ BEFORE OPERATION

Safety Precautions.....	2
Names of Parts	4
Preparation before Operation	8

OPERATION

AUTO · DRY · COOL · HEAT · FAN Operation	10
Adjusting the Airflow Direction	12
COMFORT AIRFLOW Operation.....	14
INTELLIGENT EYE Operation.....	15
POWERFUL Operation.....	17
OUTDOOR UNIT QUIET Operation	18
ECONO Operation	19
TIMER Operation.....	20
WEEKLY TIMER Operation	22

CARE

Care and Cleaning.....	29
------------------------	----

TROUBLESHOOTING

Troubleshooting	33
-----------------------	----





Safety Precautions

- Read these safety considerations for operations carefully before installing air conditioning equipment. After completing the installation, make sure that the unit operates properly during the startup operation. Instruct the customer on how to operate and maintain the unit.

Inform customers that they should store this operation manual with the installation manual for future reference.

Meanings of DANGER, WARNING, CAUTION, and NOTE Symbols:



 DANGER	 WARNING	 CAUTION
Indicates an imminently hazardous situation which, if not avoided, will result in death or serious injury.	Indicates a potentially hazardous situation which, if not avoided, could result in death or serious injury.	Indicates a potentially hazardous situation which, if not avoided, may result in minor or moderate injury. It may also be used to alert against unsafe practices.

 Never do.	 Be sure to follow the instructions.
 Be sure to ground the air conditioner.	
 Never touch the air conditioner (including the remote controller) with a wet hand.	 Never allow the air conditioner or remote controller to get wet.



DANGER

- For refrigerant leakage, consult your dealer. Refrigerant gas is heavier than air and replaces oxygen. A massive leak could lead to oxygen depletion, especially in basements, and an asphyxiation hazard could occur leading to serious injury or death.
- Refrigerant gas may produce a toxic gas if it comes in contact with fire such as from a fan heater, stove or cooking device. Exposure to this gas could cause severe injury or death.
- Any abnormalities in the operation of the air conditioner such as smoke or fire could result in severe injury or death. Turn off the power and contact your dealer immediately for instructions.
- Do not install the unit in an area where flammable materials are present due to risk of explosion resulting in serious injury or death.
- If equipment utilizing a burner is used in the same room as the air conditioner, there is the danger of oxygen deficiency which could lead to an asphyxiation hazard resulting in serious injury or death. Be sure to ventilate the room sufficiently to avoid this hazard.
- Safely dispose of the packing materials. Packing materials, such as nails and other metal or wooden parts, may cause stabs or other injuries. Tear apart and throw away plastic packaging bags so that children will not play with them. Children playing with plastic bags face the danger of death by suffocation.





WARNING

-  It is not good for health to expose your body to the air flow for a long time.
- Do not put your finger or other objects into the air outlet or inlet as the fan is rotating at high speed and could cause injury. Always keep small children away from the unit during operation.
- Do not attempt to repair, relocate, modify or reinstall the air conditioner by yourself. Incorrect work or modifications could cause electric shocks, fire or other damage. For repairs and reinstallation, consult your Daikin dealer for advice and information.
-  If the air conditioner is not cooling (heating) properly, the refrigerant may be leaking, contact your authorized dealer or qualified service repairman. When making repairs which requires adding refrigerant, consult with your authorized dealer or qualified service repairman.
- Do not attempt to install the air conditioner by yourself. Improper installation could result in water leakage, electric shocks or fire. For installation, consult your authorized dealer or a qualified technician.

CAUTION

-  The air conditioner must be grounded. Improper grounding may result in electric shocks. Do not connect the grounding wire to a gas pipe, water pipe, lightning rod, or a telephone ground line. Follow all local and state electrical codes.
-  Do not use this unit for cooling precision instruments, food, plants, animals or works of art.
- Never expose little children, plants or animals directly to the air flow.
- Do not block air inlets nor outlets. Impaired air flow may result in poor performance or equipment problems.
- Do not stand, sit, or place objects on the outdoor unit. To avoid injury, do not remove the fan guard.

CAUTION

-  • Do not place anything under the indoor or outdoor unit that must be kept away from moisture, such as electrical or electronic equipment. In certain conditions, moisture in the air may condense and drip.
 - Check the unit stand and fittings for damage annually.
 - Do not touch the air inlet and aluminum fins of outdoor unit. It may cause injury and/or damage the heat transfer surface.
 - This appliance is NOT intended for use by young children or impaired persons without proper supervision.
 - Young children should be supervised to ensure that they DO NOT play with or near the air flow of this appliance.
 - Do not pull at the conduit or hang anything on it. Otherwise it will cause fire or electric shock.
 - Do not touch the heat exchanger fins. Improper handling may result in injury.
 - Do not turn off the power immediately after stopping operation. Always wait at least 5 minutes before turning off the power to avoid water leakage or other problems.
-
-  • To avoid personal injury or equipment damage be sure to stop the operation, turn the breaker off or pull out the supply cord before cleaning or servicing the unit. NOTE: More than one disconnect may be required to shut off all power.
 - Do not connect the air conditioner to a power supply different from the one specified. It may cause improper operation or fire.
 - Depending on the environment, state and local electrical codes, a ground fault circuit interrupter may be required. Improper grounding or lack of a ground fault circuit interrupter may result in electrical shock, injuries, or death.
 - It is recommended to install a ground fault circuit interrupter if one is not already available.
This helps prevent electrical shocks or fire.
 - Arrange the drain hose to ensure smooth drainage. Improper drainage may cause water damage to the building, or its furnishing.
 - Depending on the usage environment, water may leak from the air conditioner. If this happens, contact your Daikin Dealer.
 - The remote controller should be installed in such away that children cannot play with it.
 - Do not place objects in direct proximity of the outdoor unit and do not let leaves and other debris accumulate around the unit. Leaves are a hotbed for small animals which can enter the unit. Once in the unit, such animals can cause malfunctions, smoke or fire when making contact with electrical parts.
-
-  • Do not operate the air conditioner with wet hands.
-
-  • Do not wash the indoor unit with excessive water, only use a slightly wet cloth.
 - Do not place things such as vessels containing water or anything else on top of the unit. Water may penetrate into the unit and degrade electrical insulations, resulting in an electric shock.

Installation site.

- Operate the air conditioner in a sufficiently ventilated area and not surrounded by obstacles. Do not use the air conditioner in the following places.
 - a. Places with a mist of mineral oil, such as cutting oil.
 - b. Locations such as coastal areas where there is a lot of salt in the air.
 - c. Locations such as hot springs where there is a lot of sulfur in the air.
 - d. Locations such as factories where the power voltage varies a lot.
 - e. In cars, boats, and other vehicles.
 - f. Locations such as kitchens where oil may splatter or where there is steam in the air.
 - g. Locations where equipment produces electromagnetic waves.
 - h. Places with an acid or alkaline mist.
 - i. Places where fallen leaves can accumulate or where weeds can grow.

Consider the nuisance of noise to your neighbors.

- Pay Attention to Operating Sound. Be sure to use the following places:
 - a. Places that can sufficiently withstand the weight of the air conditioner yet can suppress the operating sound and vibration of the air conditioner.
 - b. Places where warm air from the air outlet of the outside unit or the operating sound of the outside unit does not annoy neighbors. Make sure that there are no obstacles close to the outside unit. Obstacles close to the outside unit may drop the performance of the outside unit or increase the operating sound of the outside unit.
Consult your dealer if the air conditioner in operation generates unusual noise.

Electrical work.

- For power supply, be sure to use a separate power circuit dedicated to the air conditioner.

System relocation.

- Relocating the air conditioner requires specialized knowledge and skills. Please consult the dealer if relocation is necessary for moving or remodeling.

Names of Parts

Indoor Unit

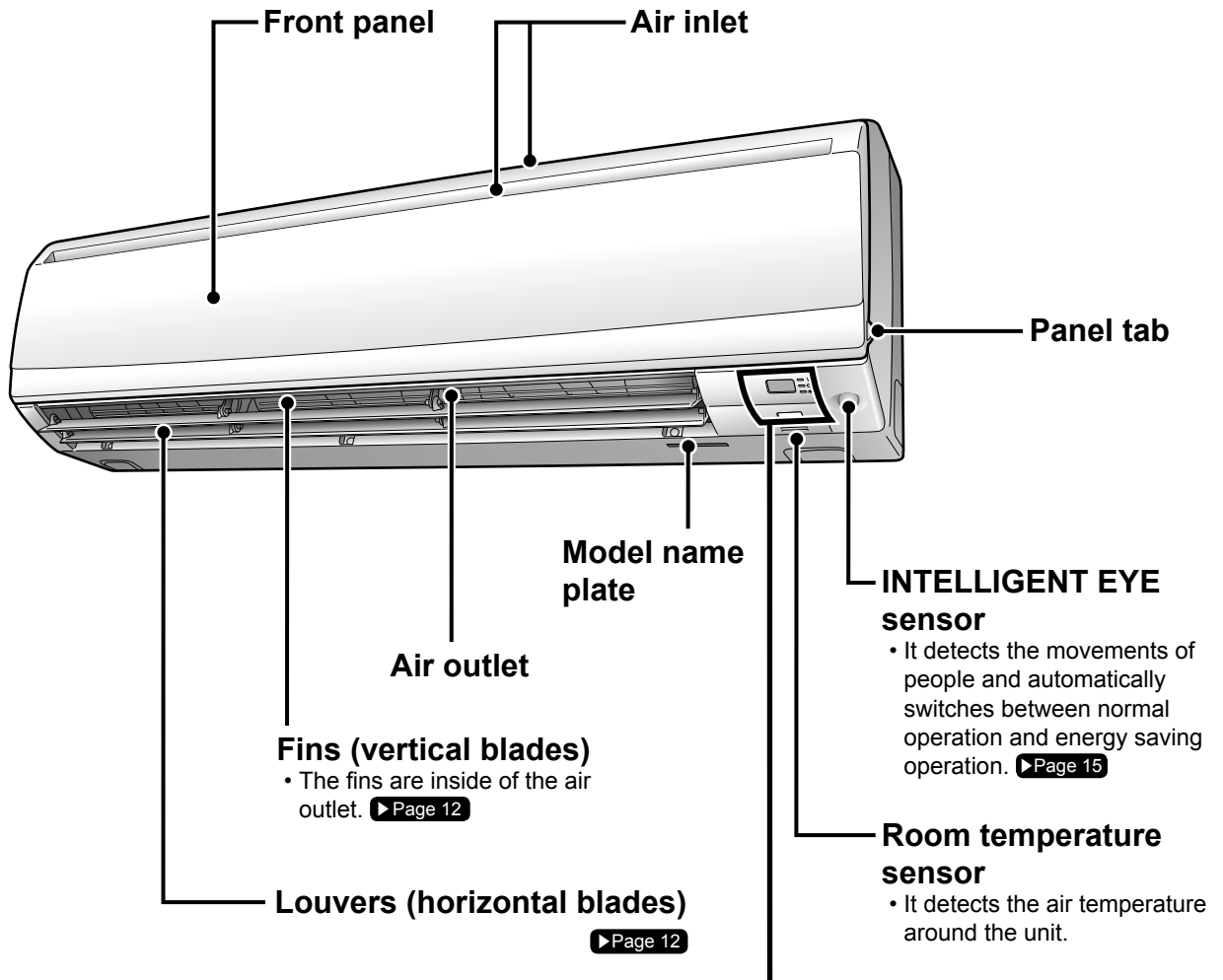

Display

Signal receiver

- It receives signals from the remote controller.
- When the unit receives a signal, you will hear a beep sound.
 - Operation start..... beep-beep
 - Settings changed..... beep
 - Operation stop..... long beep

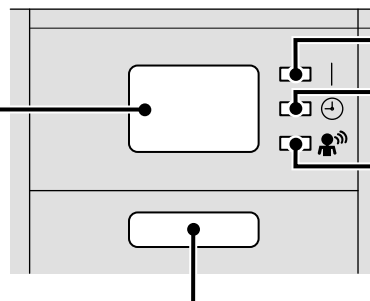

OPERATION lamp (green)

TIMER lamp (yellow) ▶Page 20

INTELLIGENT EYE lamp (green) ▶Page 15

Indoor unit ON/OFF switch

- Push this switch once to start operation. Push once again to stop it.
- The operation mode refer to the following table.

Model	Mode	Temperature setting	Airflow rate
COOLING ONLY	COOL	72°F (22°C)	AUTO
HEAT PUMP	AUTO	77°F (25°C)	AUTO

- This switch is useful when the remote controller is missing.

Open the front panel

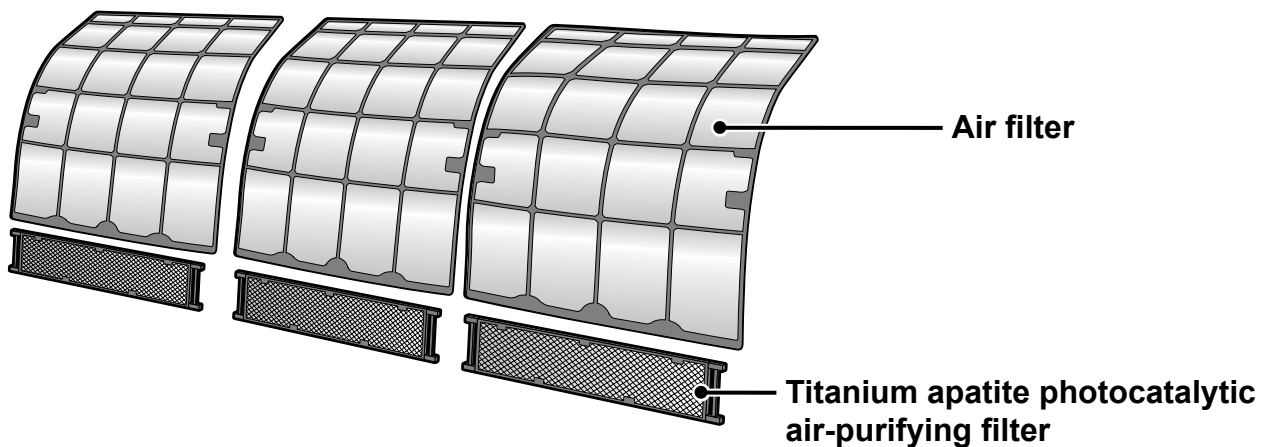
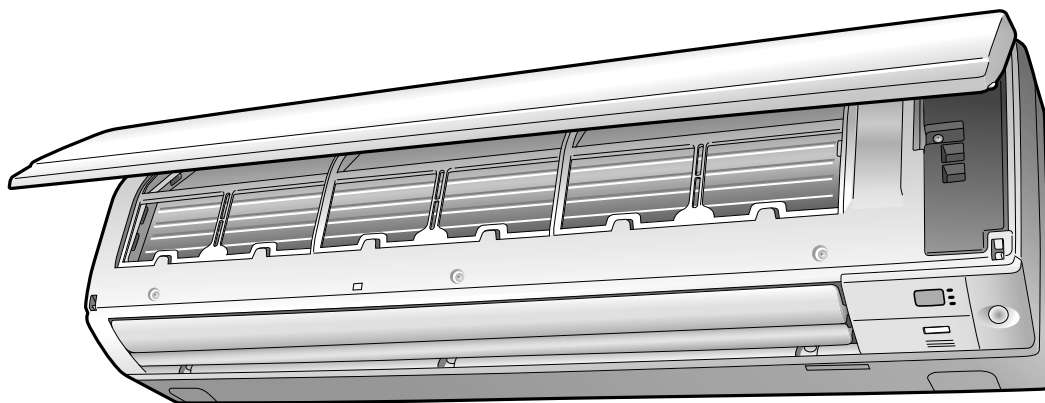

Outdoor Unit

- Appearance of the outdoor unit may differ from some models.

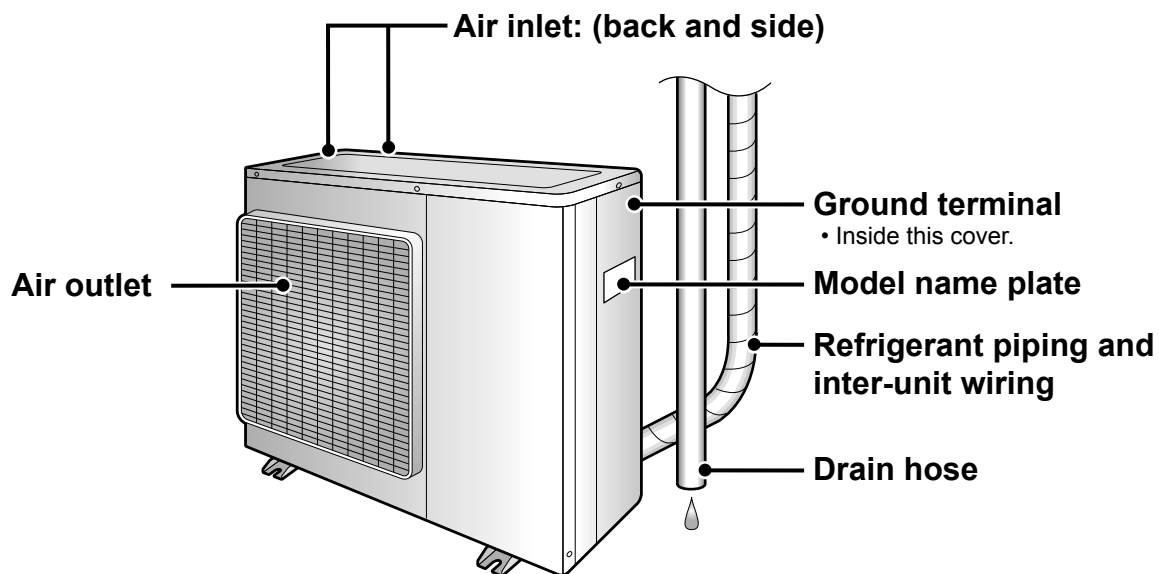

Names of Parts

Remote Controller: ARC452A21

Signal transmitter

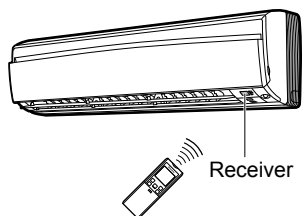

- To use the remote controller, aim the transmitter at the indoor unit. If there is anything to block signals between the unit and the remote controller, such as a curtain, the unit will not operate.
- Do not drop the remote controller. Do not get it wet.
- The maximum distance for communication is approximately 23ft (7m).

FAN setting button

- Selects the airflow rate setting.

▶Page 11

POWERFUL button

- POWERFUL operation ▶Page 17

Display (LCD)

- It displays the current settings. (In this illustration, each section is shown with its displays on for the purpose of explanation.)

TEMPERATURE adjustment buttons

- Changes the temperature setting.

▶Page 10

ON/OFF button

- Press this button once to start operation.

Press once again to stop it. ▶Page 10

Front cover

- Open the front cover. ▶Page 7

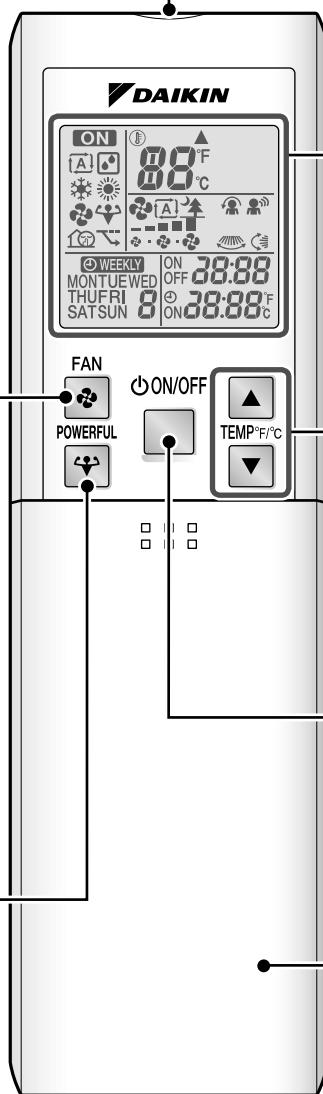

Open the front cover

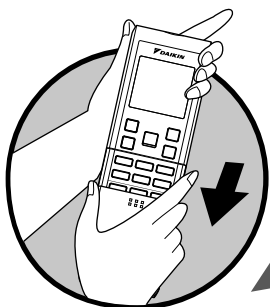

MODE selector button

- Selects the operation mode. (AUTO/DRY/COOL/HEAT/FAN) ▶Page 10

ECONO button

- ECONO operation ▶Page 19

SWING button

- Adjusting the airflow direction ▶Page 12

QUIET button

- OUTDOOR UNIT QUIET operation ▶Page 18

COMFORT/SENSOR button

- COMFORT AIRFLOW and INTELLIGENT EYE operation ▶Page 14,15,16

OFF TIMER button

▶Page 20

TIMER CANCEL button

- Cancels the timer setting. ▶Page 20,21
- It cannot be used for the WEEKLY TIMER operation.

SELECT button

- Changes the ON/OFF TIMER and WEEKLY TIMER settings. ▶Page 20,21,23

ON TIMER button

▶Page 21

CLOCK button

▶Page 9

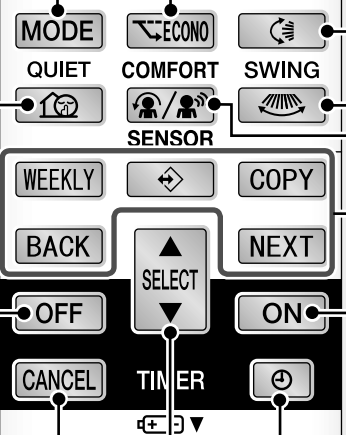

WEEKLY : WEEKLY button
 PROGRAM : PROGRAM button
 COPY : COPY button
 BACK : BACK button
 NEXT : NEXT button
 WEEKLY TIMER operation ▶Page 22

Preparation before Operation

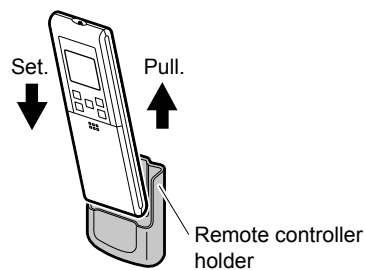
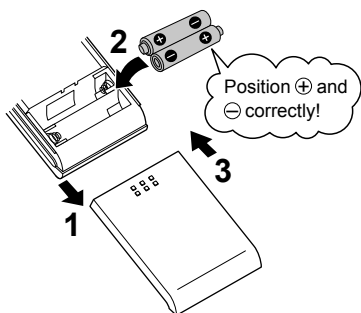

■ To set the batteries

1. Slide the front cover to take it off.
2. Set two dry batteries AAA.LR03 (alkaline).
3. Set the front cover as before.

■ To fix the remote controller holder on the wall

1. Choose a place from where the signals reach the unit.
2. Fix the holder to a wall, a pillar, etc. with the screws supplied with the holder.
3. Place the remote controller in the remote controller holder.

■ Celsius/Fahrenheit display switch

- The Celsius or Fahrenheit display is selectable with the following buttons.

Press  and  buttons simultaneously for 5 seconds.

- The temperature will be displayed in Fahrenheit if it is presently displayed in Celsius, and vice versa.

■ Turn the breaker on

- After the power is turned on, the louver of the indoor unit opens and closes once to set the reference position.

NOTE

■ Notes on batteries

- When replacing the batteries, use batteries of the same type, and replace both batteries at the same time.
- When the system is not used for a long time, take the batteries out.
- The batteries will last for approximately 1 year. If the remote controller display begins to fade and the degradation of reception performance occurs within a year, however, replace both batteries with new, size AAA.LR03 (alkaline).
- The attached batteries are provided for the initial use of the system.
The usable period of the batteries may be short depending on the manufactured date of the air conditioner.

■ Notes on remote controller

- Never expose the remote controller to direct sunlight.
- Dust on the signal transmitter or receiver will reduce the sensitivity. Wipe off dust with soft cloth.
- Signal communication may be disabled if an electronic-starter-type fluorescent lamp (such as inverter-type lamps) is in the room. Consult the shop if that is the case.
- If the remote controller signals happen to operate another appliance, move that appliance to somewhere else, or consult the service shop.

■ Celsius/Fahrenheit display change function of remote controller

- The set temperature may increase when the display is changed to Celsius from Fahrenheit, because a fraction of 0.5°C is rounded up.
- Example: A set temperature of 65°F (equivalent to 18.5°C) will be converted into 19°C.
When the display is changed to Fahrenheit again, the set temperature will be converted into 66°F (equivalent to 19°C) instead of the original set temperature (65°F) but a set temperature of 66°F (equivalent to 19°C) will be converted into 19°C with no temperature change.
- A reception sound will go off for the transmission of set temperature to the indoor unit at the time of setting the Celsius/Fahrenheit display change function.

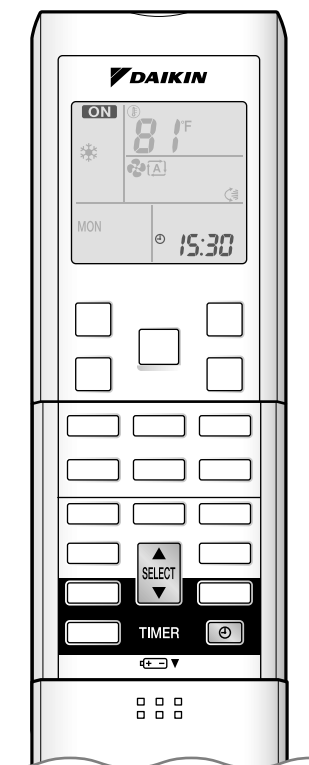

■ Checks on remote controller settings

- This remote controller is common to the heat pump model and cooling only model. Use the DIP switch on the remote controller to set the heat pump model or cooling only model.
- Refer to the following explanation and make the setting as shown in the illustration.
 - For customers of heat pump model: Set to H/P
 - For customers of cooling only model: Set to C/O

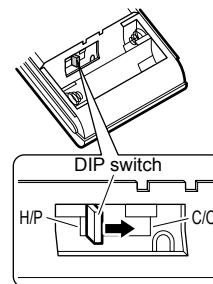

■ To set the clock

1. Press .

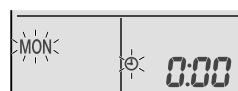

“0:00” is displayed.
“MON” and “⌚” blinks.

2. Press  to set the current day of the week.

3. Press .

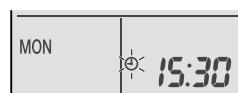

“⌚” blinks.

4. Press  to set the clock to the present time.

- Holding down ▲ or ▼ rapidly increases or decreases the time display.

5. Press .

- Point the remote controller at the indoor unit when pressing the buttons.



“.” blinks.

Operating conditions

- If the indoor unit's internal clock is not set to the correct time, the WEEKLY TIMER will not operate punctually.

■ Tips for saving energy

- Be careful not to cool (heat) the room too much.
Keeping the temperature setting at a moderate level helps save energy.
- Cover windows with a blind or a curtain.
Blocking sunlight and air from outdoors increases the cooling (heating) effect.
- Clogged air filters cause inefficient operation and waste energy. Clean them once in about every 2 weeks.

Recommended temperature setting

For cooling: 78-82°F (26-28°C)
For heating: 68-75°F (20-24°C)

■ Please note

- The air conditioner always consumes a small amount of electricity even while it is not operating.
- If you are not going to use the air conditioner for a long period, for example in spring or autumn, turn the breaker off.
- Use the air conditioner in the following conditions.

Mode	Operating conditions	If operation is continued out of this range
COOL	Outdoor temperature : 50-115°F (10-46°C) Indoor temperature : 64-90°F (18-32°C) Indoor humidity : 80% max.	<ul style="list-style-type: none"> • A safety device may work to stop the operation. • Condensation may occur on the indoor unit and drip.
HEAT	Outdoor temperature : 5-75°F (-15-24°C) Indoor temperature : 50-86°F (10-30°C)	<ul style="list-style-type: none"> • A safety device may work to stop the operation.
DRY	Outdoor temperature : 50-115°F (10-46°C) Indoor temperature : 64-90°F (18-32°C) Indoor humidity : 80% max.	<ul style="list-style-type: none"> • A safety device may work to stop the operation. • Condensation may occur on the indoor unit and drip.

- Operation outside this humidity or temperature range may cause a safety device to disable the system.

AUTO · DRY · COOL · HEAT · FAN Operation

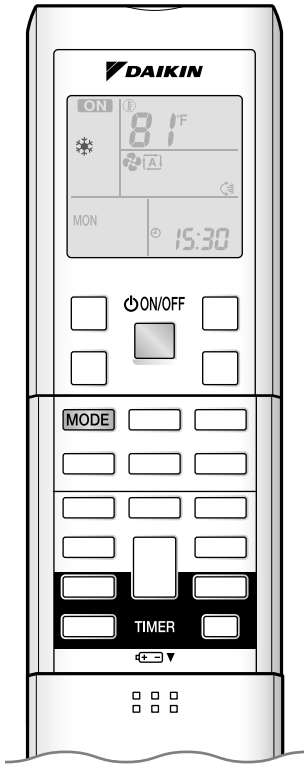

The air conditioner operates with the operation mode of your choice. From the next time on, the air conditioner will operate with the same operation mode.

■ To start operation

1. Press **MODE** and select a operation mode.

- Each pressing of the button advances the mode setting in sequence.

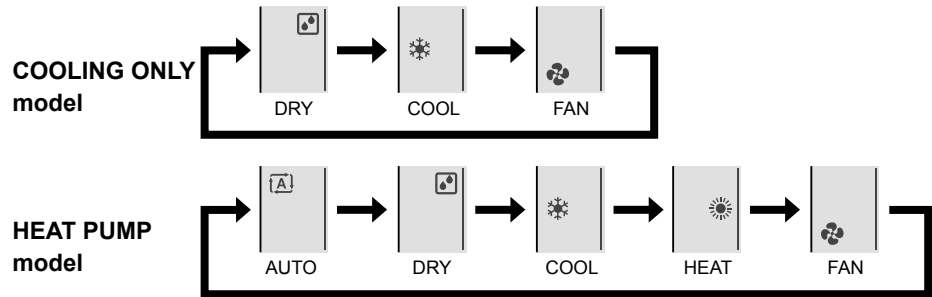

2. Press **ON/OFF**.

- “**ON**” is displayed on the LCD.
- The OPERATION lamp lights green.

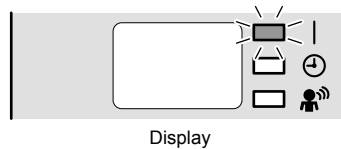

■ To stop operation

Press **ON/OFF** again.

- “**ON**” is no longer displayed on the LCD.
- The OPERATION lamp goes off.

■ To change the temperature setting

Press **▲** or **▼**.

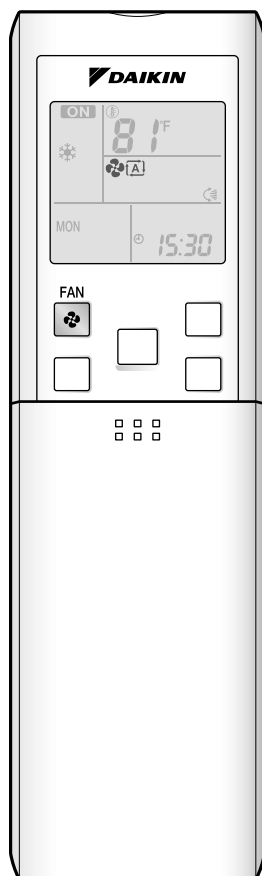

- The displayed items on the LCD will change whenever either one of the buttons is pressed.

DRY or FAN mode	COOL mode	HEAT mode	AUTO mode
The temperature setting is not variable.	64-90°F (18-32°C)	50-86°F (10-30°C)	64-86°F (18-30°C)
	Press ▲ to raise the temperature and press ▼ to lower the temperature.		



■ To change the airflow rate setting

Press .

DRY mode	AUTO or COOL or HEAT or FAN mode
The airflow rate setting is not variable.	Five levels of airflow rate setting from “  ” to “  ” plus “  ” and “  ” are available. 

- Indoor unit quiet operation
When the airflow is set to “”, the noise from the indoor unit will become quieter. Use this when making the noise quieter. The unit might lose capacity when the airflow rate is set to a weak level.
- Each pressing of the button advances the airflow rate setting in sequence.

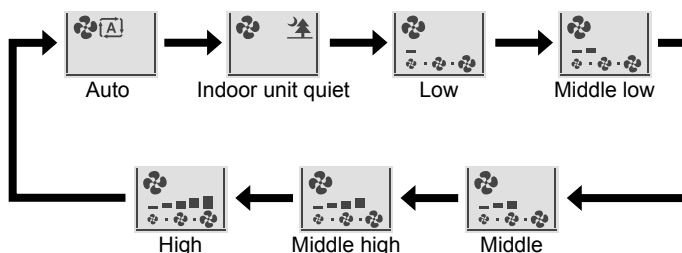

NOTE

■ Note on HEAT operation

- Since this air conditioner heats the room by taking heat from outdoor air to indoors, the heating capacity becomes smaller in lower outdoor temperatures. If the heating effect is insufficient, it is recommended to use another heating appliance in combination with the air conditioner.
- The heat pump system heats the room by circulating hot air around all parts of the room. After the start of heating operation, it takes some time before the room gets warmer.
- In heating operation, frost may occur on the outdoor unit and lower the heating capacity. In that case, the system switches into defrosting operation to take away the frost.
- During defrosting operation, hot air does not flow out of indoor unit.

■ Note on COOL operation

- This air conditioner cools the room by releasing the heat in the room outside. Therefore, the cooling performance of the air conditioner may be degraded if the outdoor temperature is high.

■ Note on DRY operation

- The computer chip works to rid the room of humidity while maintaining the temperature as much as possible. It automatically controls temperature and airflow rate, so manual adjustment of these functions is unavailable.

■ Note on AUTO operation

- In AUTO operation, the system selects an appropriate operation mode (COOL or HEAT) based on the room and outside temperatures and starts the operation.
- The system automatically reselects setting at a regular interval to bring the room temperature to user-setting level.

■ Note on FAN operation

- This mode is valid for fan only.

■ Note on airflow rate setting

- At smaller airflow rates, the cooling (heating) effect is also smaller.

Adjusting the Airflow Direction

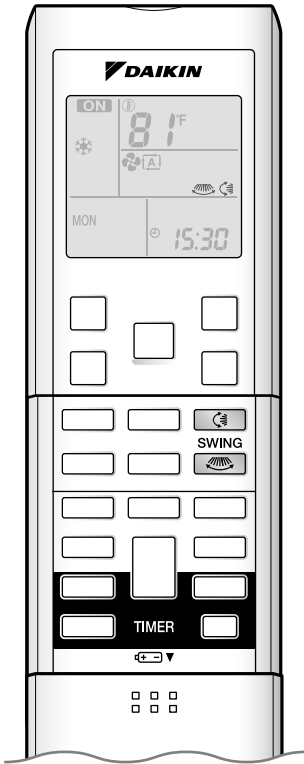

You can adjust the airflow direction to increase your comfort.

Adjusting the upper and lower airflow direction

■ To adjust the louvers (horizontal blades)

1. Press .

- “” is displayed on the LCD and the louvers will begin to swing.

2. When the louvers have reached the desired position, press  once more.

- The louvers will stop moving.
- “” is no longer displayed on the LCD.

Adjusting the right and left airflow direction

■ To adjust the fins (vertical blades)

3. Press .

- “” is displayed on the LCD.

4. When the fins have reached the desired position, press the  once more.

- The fins will stop moving.
- “” is no longer displayed on the LCD.

Adjusting the 3-D airflow direction

■ To start 3-D airflow

1. 3. Press the  and the  :
the “” and “” display will light up and the louvers and fins will move in turn.

■ To cancel 3-D airflow

2. 4. Press either the  or the .

■ COMFORT AIRFLOW operation

- Check COMFORT AIRFLOW operation in the section of “COMFORT AIRFLOW Operation” and “INTELLIGENT EYE Operation”. ▶Page 14,15

NOTE

■ Notes on louvers and fins angles

- When “**SWING button**” is selected, the louvers swinging range depends on the operation. (See the figure.)

Three-dimensional (3-D) airflow

- Using three-dimensional airflow circulates cold air, which tends to be collected at the bottom of the room, and hot air, which tends to collect near the ceiling, throughout the room, preventing areas of cold and hot developing.

■ ATTENTION

- Always use a remote controller to adjust the angles of the louvers and fins. If you attempt to move it forcibly with hand when it is swinging, the mechanism may be broken.
- Always use a remote controller to adjust the fins angles. In side the air outlet, a fan is rotating at a high speed.

COOL and DRY operation

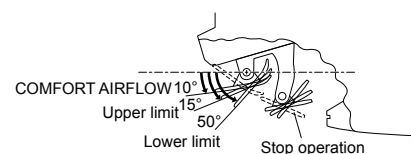

HEAT operation

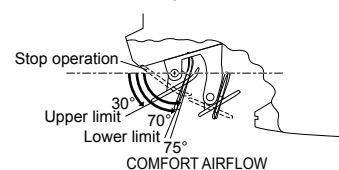

FAN operation

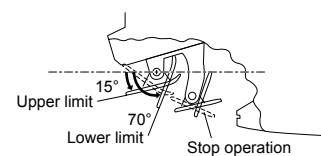

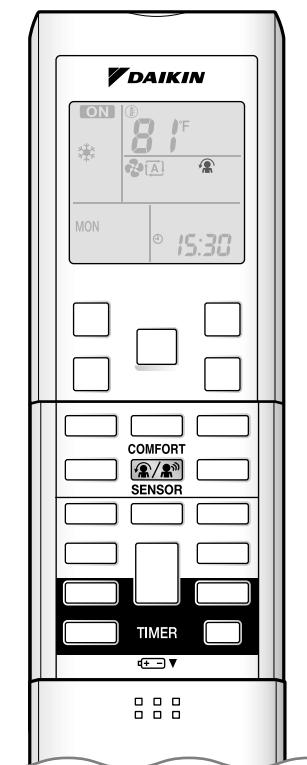

COMFORT AIRFLOW Operation



The flow of air will be in the upward direction while in COOL operation and in the downward direction while in HEAT operation, which will provide a comfortable wind that will not come in direct contact with people.

■ To start COMFORT AIRFLOW operation

1. Press and select “” on the LCD.

- Each time the  is pressed a different setting option is displayed on the LCD.
- By selecting “·” from the following icons, the air conditioner will be in COMFORT AIRFLOW operation combined with INTELLIGENT EYE operation. [▶Page 16](#)



■ To cancel COMFORT AIRFLOW operation

2. Press .

- Press the button to select “Blank”.

NOTE

■ Notes on COMFORT AIRFLOW operation

- The louvers position will change, preventing air from blowing directly on the occupants of the room.
- POWERFUL operation and COMFORT AIRFLOW operation cannot be used at the same time.
- The volume of air will be set to AUTO. If the upward and downward airflow direction is selected, the COMFORT AIRFLOW function will be canceled.
- Priority is given to the function of whichever button is pressed last.
- The COMFORT AIRFLOW function makes the following airflow direction adjustments.
The louvers will move upward while cooling so that the airflow will be directed upward.
The louvers will move downward while heating so that the airflow will be directed downward.

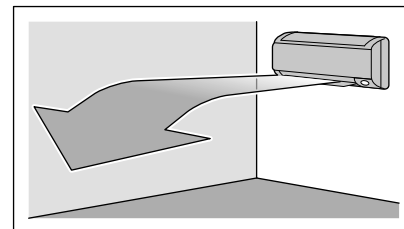

COOL operation

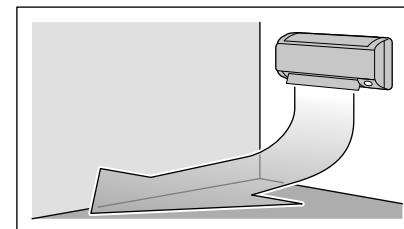

HEAT operation

INTELLIGENT EYE Operation

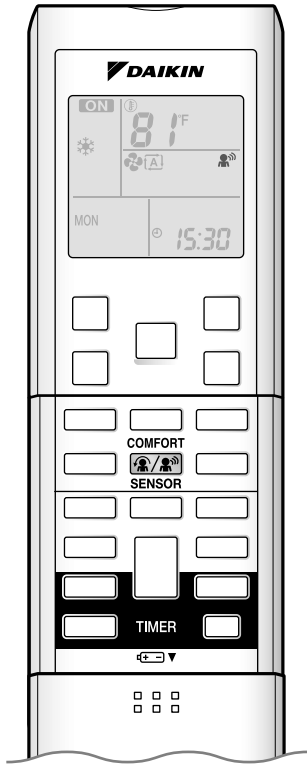

“INTELLIGENT EYE” is the infrared sensor which detects the human movement.

■ To start INTELLIGENT EYE operation

1. Press and select “” on the LCD.

- Each time the  is pressed a different setting option is displayed on the LCD.
- The INTELLIGENT EYE lamp lights green.

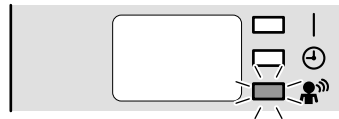

Display

- By selecting “” from the following icons, the air conditioner will be in INTELLIGENT EYE operation combined with COMFORT AIRFLOW operation. [▶Page 16](#)



- When the louvers (horizontal blades) are swinging, the operating as above will stop movement of them.
- The lamp will be lit while human movements are detected.

■ To cancel the INTELLIGENT EYE operation

2. Press .

- Press the button to select “Blank”.

[EX.]

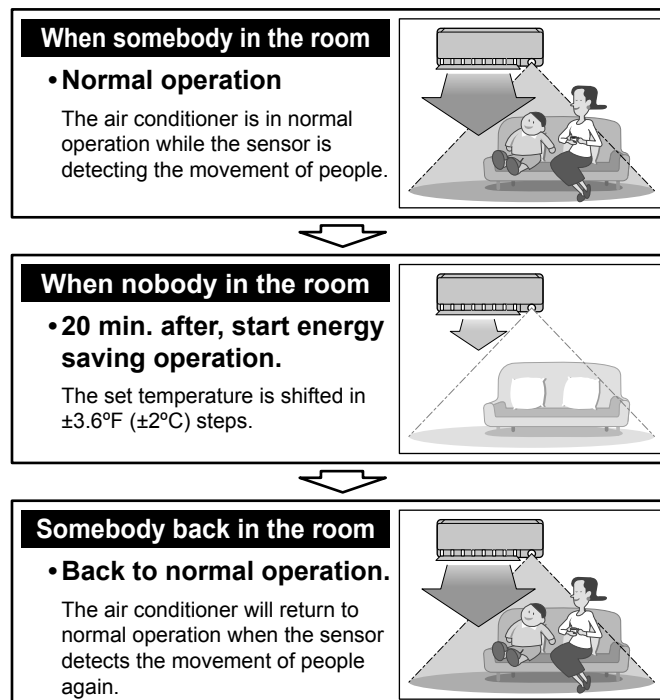

INTELLIGENT EYE Operation

“INTELLIGENT EYE” is useful for energy saving

■ Energy saving operation

- Change the temperature -3.6°F (-2°C) in heating / $+3.6^{\circ}\text{F}$ ($+2^{\circ}\text{C}$) in cooling / $+3.6^{\circ}\text{F}$ ($+2^{\circ}\text{C}$) in dry mode from set temperature. When the room temperature exceeds 86°F (30°C), the operation changes the temperature $+1.8^{\circ}\text{F}$ ($+1^{\circ}\text{C}$) in COOL / $+1.8^{\circ}\text{F}$ ($+1^{\circ}\text{C}$) in DRY mode from set temperature.
- Decrease the airflow rate slightly in FAN mode only.
- If no presence detected in the room for 20 minutes.

NOTE

■ Notes on “INTELLIGENT EYE”

- Application range is as follows.

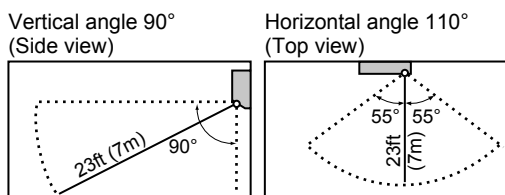

- Sensor may not detect moving objects further than 23ft (7m) away. (Check the application range)
- Sensor detection sensitivity changes according to indoor unit location, the speed of passersby, temperature range, etc.
- The sensor also mistakenly detects pets, sunlight, fluttering curtains and light reflected off of mirrors as passersby.
- INTELLIGENT EYE operation will not go on during POWERFUL operation.
- NIGHT SET mode [▶Page 20](#) will not go on during use of INTELLIGENT EYE operation.

■ To combine “COMFORT AIRFLOW operation” and “INTELLIGENT EYE operation”

1. Press and select “” on the LCD.

- Each time the  is pressed a different setting option is displayed on the LCD.



■ To cancel “COMFORT AIRFLOW operation” and “INTELLIGENT EYE operation”

2. Press .

- Press the button to select “Blank”.

- The air conditioner can go into operation with the COMFORT AIRFLOW and INTELLIGENT EYE functions combined.
- The volume of air will be set to AUTO. If the upward and downward airflow direction is selected, the COMFORT AIRFLOW operation will be canceled.
- Priority is given to the function of whichever button is pressed last.

CAUTION

- Do not place large objects near the sensor.
Also keep heating units or humidifiers outside the sensor's detection area. This sensor can detect undesirable objects.
- Do not hit or violently push the INTELLIGENT EYE sensor. This can lead to damage and malfunction.

POWERFUL Operation

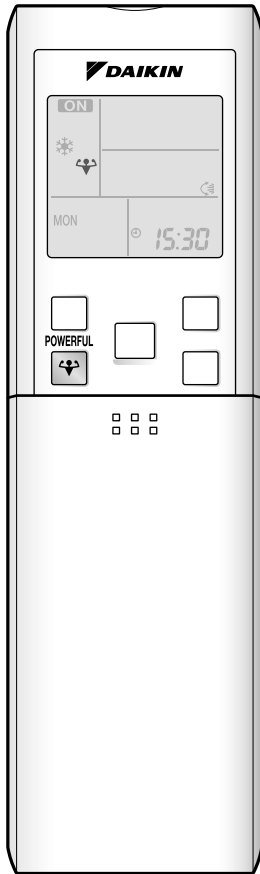

POWERFUL operation quickly maximizes the cooling (heating) effect in any operation mode. You can get the maximum capacity.

■ To start POWERFUL operation

Press  during operation.

- POWERFUL operation ends in 20 minutes. Then the system automatically operates again with the previous settings which were used before POWERFUL operation.
- “” is displayed on the LCD.
- When using POWERFUL operation, there are some functions which are not available.

■ To cancel POWERFUL operation

Press  again.

- “” is no longer displayed on the LCD.

NOTE

■ Notes on POWERFUL operation

- POWERFUL operation cannot be used together with ECONO, COMFORT AIRFLOW or QUIET operation.
- POWERFUL operation will not increase the capacity of the air conditioner if the air conditioner is already in operation with its maximum capacity demonstrated.
- **In COOL, HEAT and AUTO operation**
To maximize the cooling (heating) effect, the capacity of outdoor unit is increased and the airflow rate is fixed to the maximum setting. The temperature and airflow settings are not variable.
- **In DRY operation**
The temperature setting is lowered by 4.5°F (2.5°C) and the airflow rate is slightly increased.
- **In FAN operation**
The airflow rate is fixed to the maximum setting.

OUTDOOR UNIT QUIET Operation

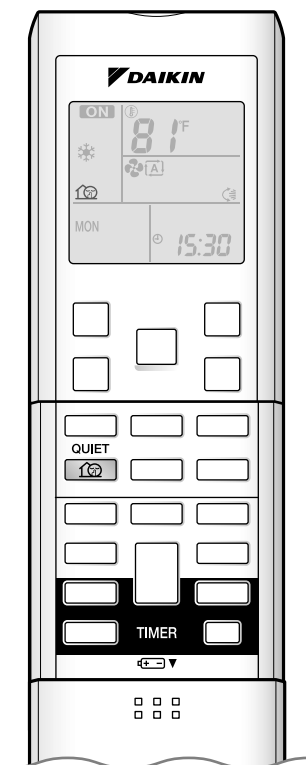

OUTDOOR UNIT QUIET operation lowers the noise level of the outdoor unit by changing the frequency and fan speed on the outdoor unit. This function is convenient during night.

■ To start OUTDOOR UNIT QUIET operation

Press .

- “” is displayed on the LCD.

■ To cancel OUTDOOR UNIT QUIET operation

Press  again.

- “” is no longer displayed on the LCD.

NOTE

■ Notes on OUTDOOR UNIT QUIET operation

- This function is available in COOL, HEAT, and AUTO operation.
(This is not available in FAN and DRY operation.)
- POWERFUL operation and OUTDOOR UNIT QUIET operation cannot be used at the same time.
Priority is given to the function of whichever button is pressed last.
- If operation is stopped using the remote controller or the indoor unit ON/OFF switch when using OUTDOOR UNIT QUIET operation, “” will remain on the remote controller display.
- OUTDOOR UNIT QUIET operation will drop neither the frequency nor fan speed if the frequency and fan speed have been already dropped low enough.
- This operation is performed with lower power and therefore may not provide a sufficient cooling (heating) effect.

ECONO Operation

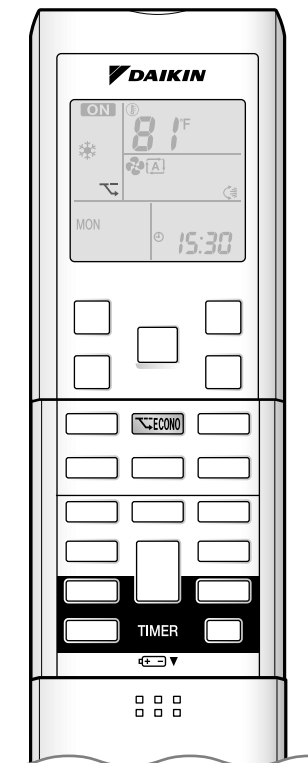

ECONO operation is a function which enables efficient operation by limiting the maximum power consumption value. This function is useful for cases in which attention should be paid to ensure a circuit breaker will not trip when the product runs alongside other appliances.

■ To start ECONO operation

Press  during operation.

- “” is displayed on the LCD.

■ To cancel ECONO operation

Press  again.

- “” is no longer displayed on the LCD.

Running current and power consumption

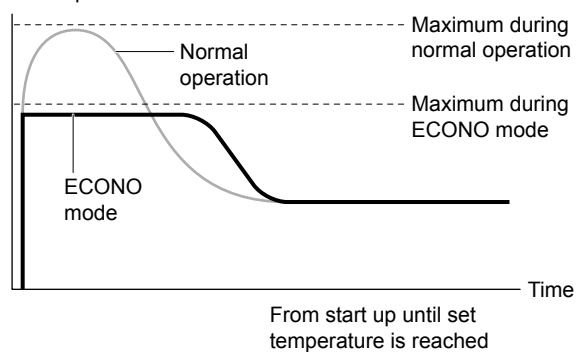

- This diagram is a representation for illustrative purposes only. The maximum running current and power consumption of the air conditioner in ECONO operation vary with the connecting outdoor unit.

NOTE

■ Notes on ECONO operation

- ECONO operation can only be set when the unit is running. Pressing the operation stop button causes the settings to be canceled, and the “” is no longer displayed on the LCD.
- ECONO operation is a function which enables efficient operation by limiting the power consumption of the outdoor unit (operating frequency).
- ECONO operation functions in AUTO, COOL, DRY, and HEAT operation.
- POWERFUL and ECONO operation cannot be used at the same time. Priority is given to the function of whichever button is pressed last.
- If the level of power consumption is already low, ECONO operation will not drop the power consumption.

TIMER Operation

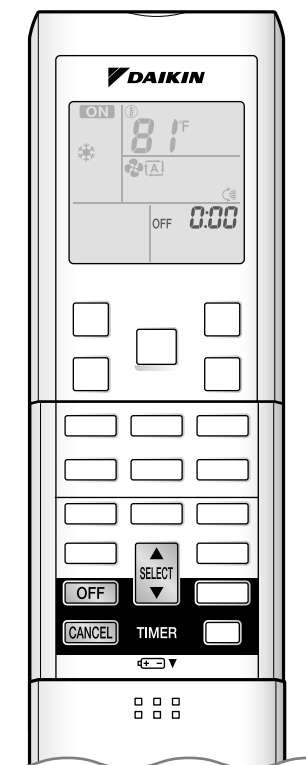

Timer functions are useful for automatically switching the air conditioner on or off at night or in the morning. You can also use OFF TIMER and ON TIMER in combination.

■ To use OFF TIMER operation

- Check that the clock is correct.
If not, set the clock to the present time. ▶Page 9

1. Press **OFF** .



- “⌚” and day of the week are no longer displayed on the LCD.

2. Press **SELECT** until the time setting reaches the point you like.

- Each pressing of either button increases or decreases the time setting by 10 minutes.
Holding down either button changes the time setting rapidly.

3. Press **OFF** again.

- “OFF” and setting time are displayed on the LCD.
- The TIMER lamp lights yellow.

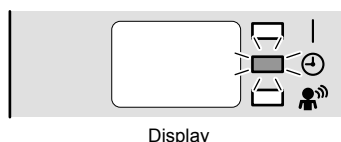

■ To cancel OFF TIMER operation

Press **CANCEL** .

- “OFF” and setting time are no longer displayed on the LCD.
- “⌚” and day of the week are displayed on the LCD.
- The TIMER lamp goes off.

NOTE

■ Notes on TIMER operation

- When TIMER is set, the present time is not displayed.
- Once you set ON, OFF TIMER, the time setting is kept in the memory. (The memory is canceled when remote controller batteries are replaced.)
- When operating the unit via the ON/OFF TIMER, the actual length of operation may vary from the time entered by the user. (Maximum approximately 10 minutes)

■ NIGHT SET mode

When the OFF TIMER is set, the air conditioner automatically adjusts the temperature setting (0.9°F (0.5°C) up in COOL, 3.6°F (2.0°C) down in HEAT) to prevent excessive cooling (heating) for your pleasant sleep.

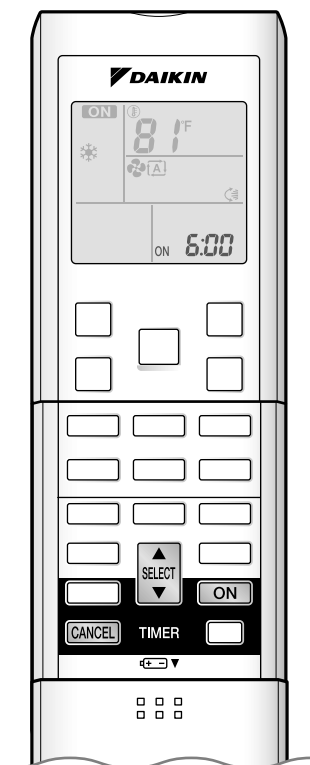

■ To use ON TIMER operation

- Check that the clock is correct.
If not, set the clock to the present time. ▶Page 9

1. Press **ON** .



“6:00” is displayed.

“ ON ” blinks.

- “ ⌚ ” and day of the week are no longer displayed on the LCD.

2. Press **SELECT** until the time setting reaches the point you like.

- Each pressing of either button increases or decreases the time setting by 10 minutes.
Holding down either button changes the time setting rapidly.

3. Press **ON** again.

- “ ON ” and setting time are displayed on the LCD.
- The TIMER lamp lights yellow.



Display

■ To cancel ON TIMER operation

Press **CANCEL** .

- “ ON ” and setting time are no longer displayed on the LCD.
- “ ⌚ ” and day of the week are displayed on the LCD.
- The TIMER lamp goes off.

■ To combine ON TIMER and OFF TIMER

- A sample setting for combining the 2 timers is shown below.

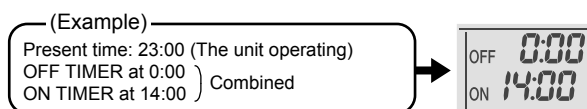

NOTE

■ In the following cases, set the timer again.

- After a breaker has turned off.
- After a power failure.
- After replacing batteries in the remote controller.

WEEKLY TIMER Operation

Up to 4 timer settings can be saved for each day of the week. It is convenient if the WEEKLY TIMER is set according to the family's life style.

■ Using in these cases of WEEKLY TIMER

An example of WEEKLY TIMER settings is shown below.

Example: The same timer settings are made for the week from Monday through Friday while different timer settings are made for the weekend.

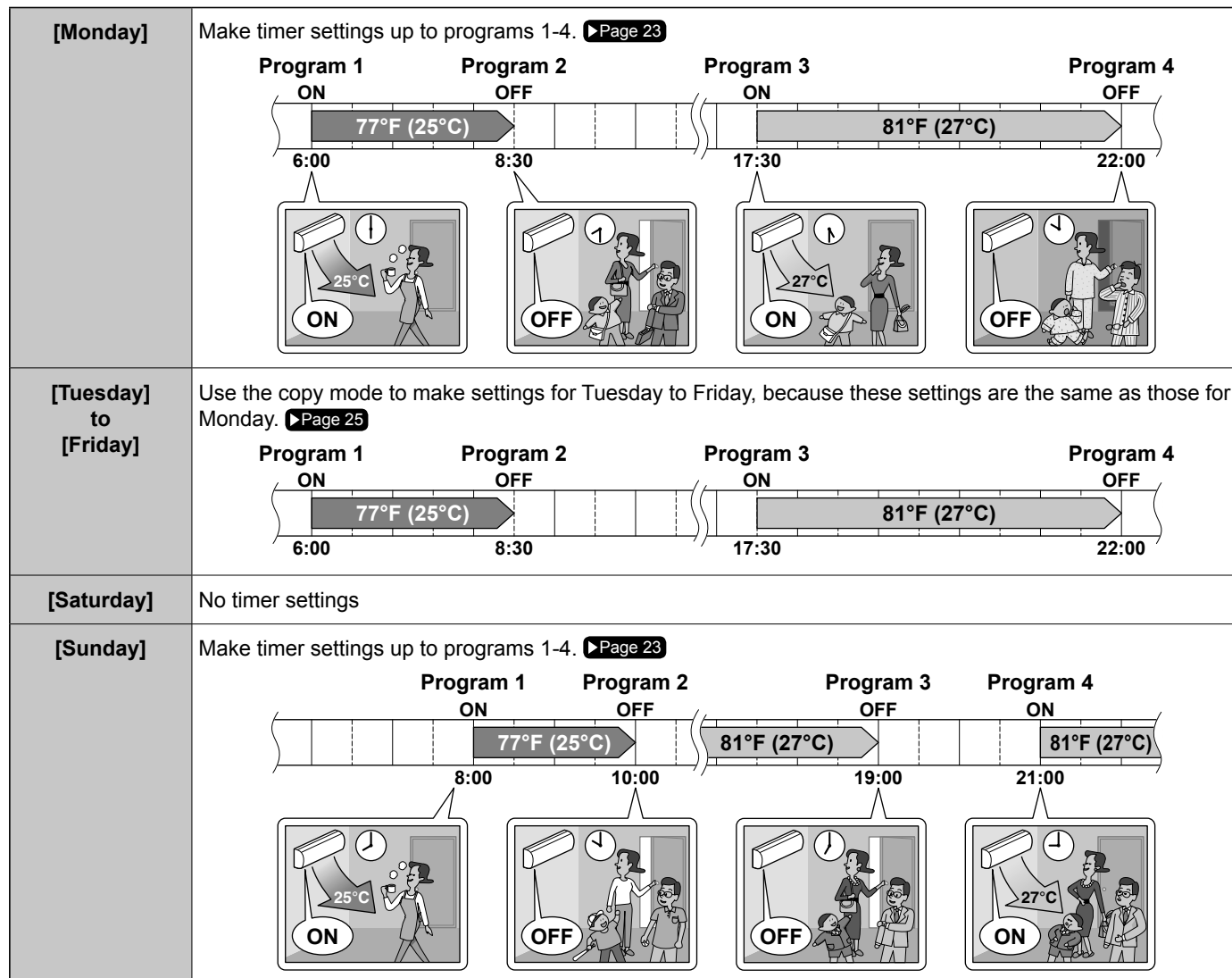

- Up to 4 reservations per day and 28 reservations per week can be set in the WEEKLY TIMER. The effective use of the copy mode ensures ease of making reservations.
- The use of ON-ON-ON-ON settings, for example, makes it possible to schedule operating mode and set temperature changes. Furthermore, by using OFF-OFF-OFF-OFF settings, only the turn-off time of each day can be set. This will turn off the air conditioner automatically if the user forgets to turn it off.

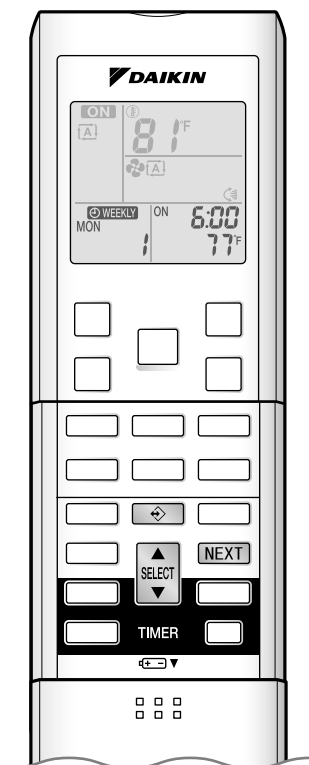

■ To use WEEKLY TIMER operation

Setting mode

- Make sure the day of the week and time are set. If not, set the day of the week and time.

▶Page 9

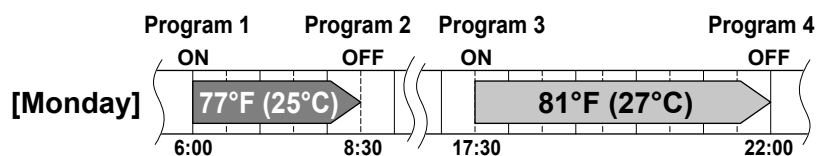

Setting Displays

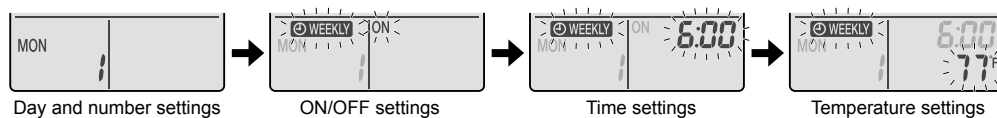

1. Press .

- The day of the week and the reservation number of the current day will be displayed.
- 1 to 4 settings can be made per day.

2. Press to select the desired day of the week and reservation number.

- Pressing  changes the reservation number and the day of the week.

3. Press .

- The day of the week and reservation number will be set.
- “WEEKLY” and “ON” blink.

4. Press to select the desired mode.

- Pressing  changes “ON” or “OFF” setting in sequence.



- In case the reservation has already been set, selecting “blank” deletes the reservation.
- Go to STEP 9 if “blank” is selected.

5. Press .

- The ON/OFF TIMER mode will be set.
- “WEEKLY” and the time blink.

WEEKLY TIMER Operation

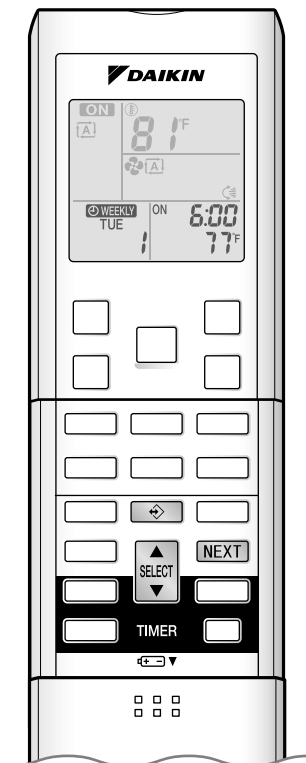

6. Press to select the desired time.

- The time can be set between 0:00 and 23:50 in 10 minute intervals.
- To return to the ON/OFF TIMER mode setting, press .
- Go to STEP 9 when setting the OFF TIMER.

7. Press .

- The time will be set.
- “ WEEKLY” and the temperature blink.

8. Press to select the desired temperature.

- The temperature can be set between 50°F (10°C) and 90°F (32°C).
Cooling: The unit operates at 64°F (18°C) even if it is set at 50 (10) to 63°F (17°C).
Heating: The unit operates at 86°F (30°C) even if it is set at 87 (31) to 90°F (32°C).
- To return to the time setting, press .
- The set temperature is only displayed when the mode setting is on.

9. Press .

- The temperature will be set and go to the next reservation setting.
- To continue further settings, repeat the procedure from STEP 4.

10. Press to complete the setting.

- Be sure to direct the remote controller toward the indoor unit and check for a receiving tone and flashing the operation lamp.
- “ WEEKLY” is displayed on the LCD and WEEKLY TIMER operation is activated.
- The TIMER lamp lights yellow.







Display

- A reservation made once can be easily copied and the same settings used for another day of the week. Refer to **Copy mode**. 

NOTE

■ Notes on WEEKLY TIMER operation

- Do not forget to set the clock on the remote controller first. 
- The day of the week, ON/OFF TIMER mode, time and set temperature (only for ON TIMER mode) can be set with WEEKLY TIMER. Other settings for ON TIMER are based on the settings just before the operation.
- Both WEEKLY TIMER and ON/OFF TIMER operation cannot be used at the same time. The ON/OFF TIMER operation has priority if it is set while WEEKLY TIMER is still active. The WEEKLY TIMER will go into standby state, and “ WEEKLY” will be no longer displayed on the LCD. When ON/OFF TIMER is up, the WEEKLY TIMER will automatically become active.
- Only the time and set temperature set with the weekly timer are sent with the .
Set the weekly timer only after setting the operation mode, the fan strength, and the fan direction ahead of time.
- Shutting the breaker off, power failure, and other similar events will render operation of the indoor unit's internal clock inaccurate. Reset the clock. 
- The  can be used only for the time and temperature settings.
It cannot be used to go back to the reservation number.

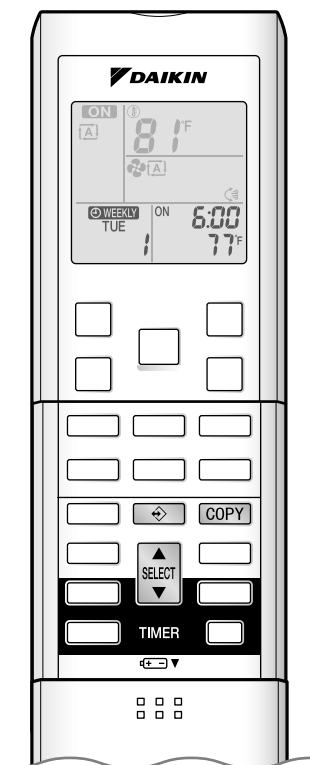





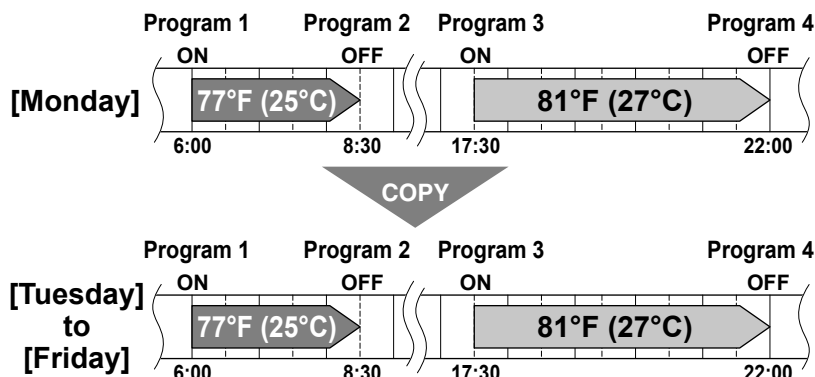

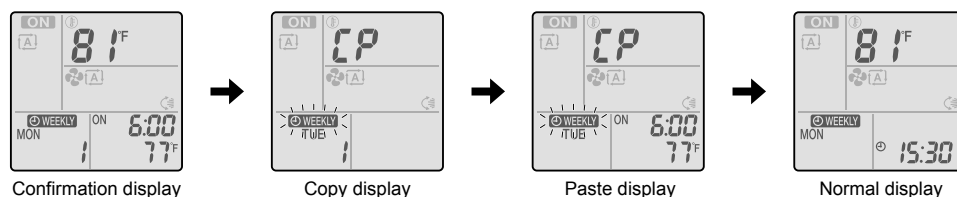

Copy mode

- A reservation made once can be copied another day of the week. The whole reservation of the selected day of the week will be copied.



Setting Displays





1. Press .
2. Press  to confirm the day of the week to be copied.
3. Press  to activate copy mode.
 - The whole reservation of the selected day of the week will be copied.
4. Press  to select the destination day of the week.
5. Press .
 - The reservation will be copied to the selected day of the week. The whole reservation of the selected day of the week will be copied.
 - To continue copying the settings to other days of the week, repeat STEP 4 and STEP 5.
6. Press  to complete the setting.
 - “ WEEKLY ” is displayed on the LCD and WEEKLY TIMER operation is activated.

NOTE

■ Notes on copy mode

- The entire reservation of the source day of the week is copied in the copy mode.

In the case of making a reservation change for any day of the week individually after copying the content of weekly reservations, press  and change the settings in the steps of **Setting mode** .  Page 23

WEEKLY TIMER Operation

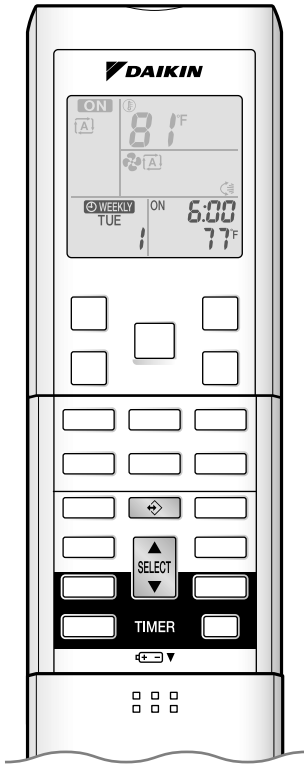

■ Confirming a reservation

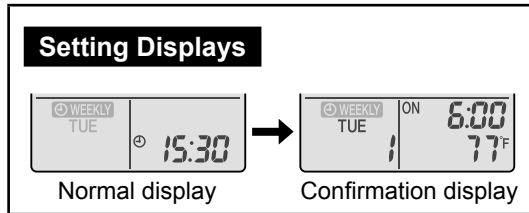

- The reservation can be confirmed.



1. Press .

- The day of the week and the reservation number of the current day will be displayed.

2. Press to select the day of the week and the reservation number to be confirmed.

- Pressing  displays the reservation details.
- To change the confirmed reserved settings, select the reservation number and press . The mode is switched to setting mode. Go to **Setting mode** STEP 4. ▶Page 23

3. Press to exit confirming mode.

- “  WEEKLY ” is displayed on the LCD and WEEKLY TIMER operation is activated.
- The TIMER lamp lights yellow.

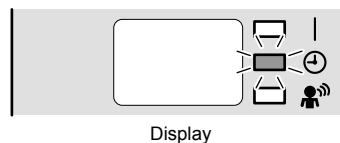

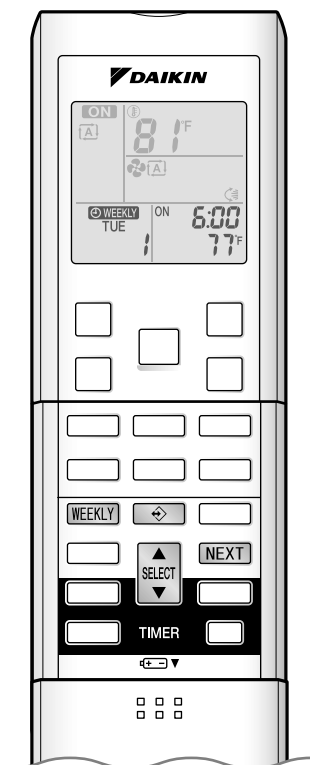

■ To deactivate WEEKLY TIMER operation

Press **WEEKLY** while “**⊖ WEEKLY**” is displayed on the LCD.

- The “**⊖ WEEKLY**” will be no longer displayed on the LCD.
- The TIMER lamp goes off.
- To reactivate the WEEKLY TIMER operation, press **WEEKLY** again.
- If a reservation deactivated with **WEEKLY** is activated once again, the last reservation mode will be used.

■ To delete reservations

The individual reservation

1. Press  .

- The day of the week and the reservation number will be displayed.

2. Press  **to select the day of the week and the reservation number to be deleted.**

3. Press **NEXT** .

- “**⊖ WEEKLY**” and “ON” or “OFF” blink.
- Pressing  changes ON/OFF TIMER mode.
- The reservation will be no setting with selecting “blank”.

4. Press  **and select “blank”.**

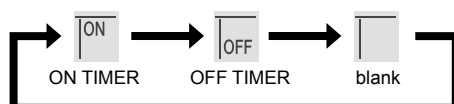

5. Press **NEXT** .

- The selected reservation is be deleted.

WEEKLY TIMER Operation

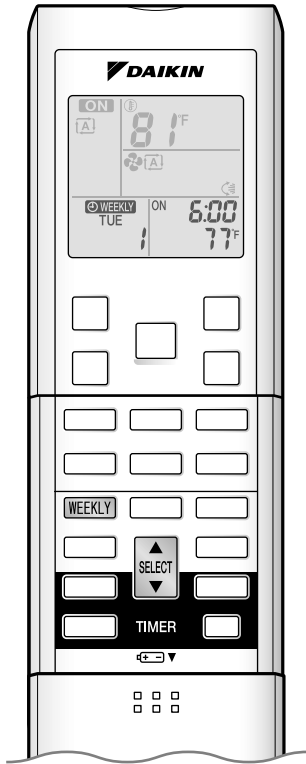

The reservations for each day of the week

- This function can be used for deleting reservations for each day of the week.

1. Press  .

2. Press  to select the day of the week to be deleted.

3. Hold  for 5 seconds.

- The reservation of the selected day of the week will be deleted.

All reservations

Hold  for 5 seconds while normal display.

- Be sure to direct the remote controller toward the indoor unit and check for a receiving tone.
- This operation is not effective while WEEKLY TIMER is being set.
- All reservations will be deleted.

Care and Cleaning



CAUTION

Before cleaning, be sure to stop the operation and turn the breaker off.

Units

Indoor unit and remote controller

- Wipe them with a soft cloth when dirty.

Front panel

1. Open the front panel.

- Hold the front panel by the panel tabs on the both sides and open it.

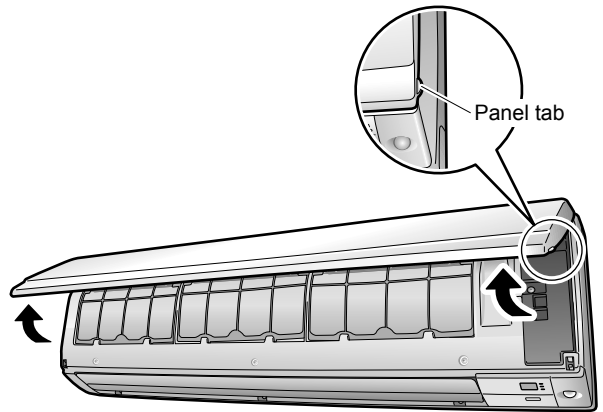

2. Remove the front panel.

- Slide the front panel to either the left or right and pulling it toward you. This will disconnect the front panel shaft on one side.

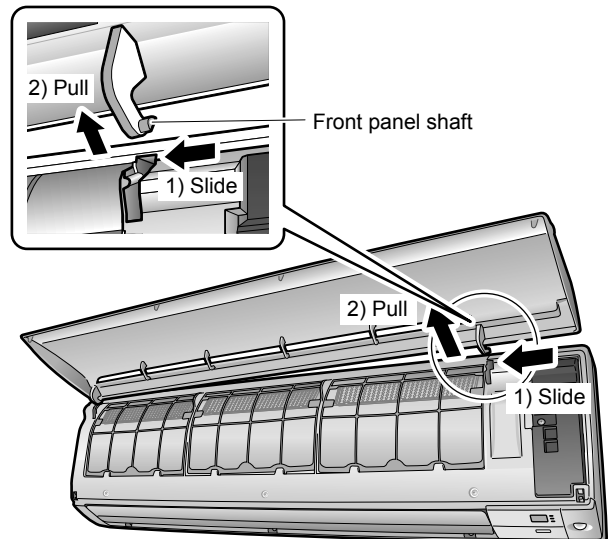

3. Clean the front panel.

- Wipe it with a soft cloth soaked in water.
- Only neutral detergent may be used.
- In case of washing the panel with water, wipe it with dry soft cloth, dry it up in the shade after washing.

4. Attach the front panel.

- Align the front panel shaft on the left and right of the front panel with the slots, then push them all the way in.
- Close the front panel slowly. (Press the panel at both sides and the central area.)

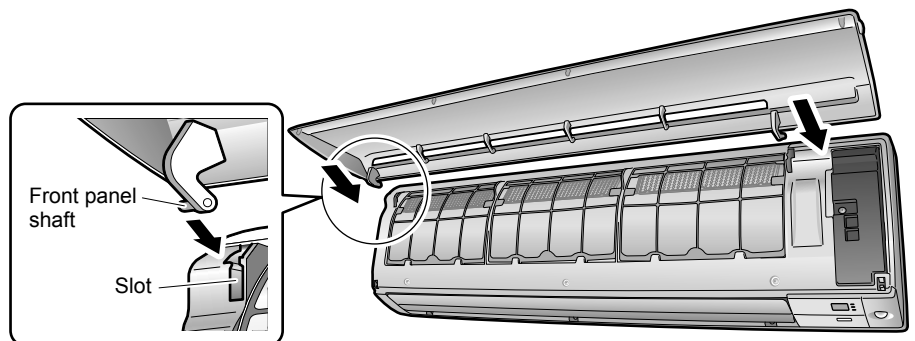

CAUTION

- Do not touch the aluminum fins of the indoor unit. If you touch those parts, this may cause an injury.
- When removing or attaching the front panel, use a robust and stable stool and watch your steps carefully.
- When removing or attaching the front panel, support the panel securely with hand to prevent it from falling.
- For cleaning, do not use hot water above 104°F (40°C), benzene, gasoline, thinner, nor other volatile oils, polishing compound, scrubbing brushes, nor other hand stuff.
- After cleaning, make sure that the front panel is securely fixed.

Care and Cleaning

Filters

1. Open the front panel. ▶Page 29

2. Pull out the air filters.

- Push the filter tab at the center of each air filter slightly upward, then pull it down.

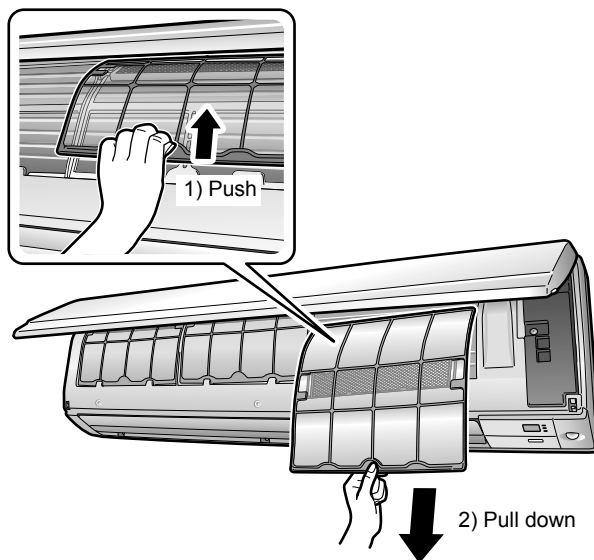

3. Take off the titanium apatite photocatalytic air-purifying filter.

- Hold the recessed parts of the frame and unhook the 4 claws.

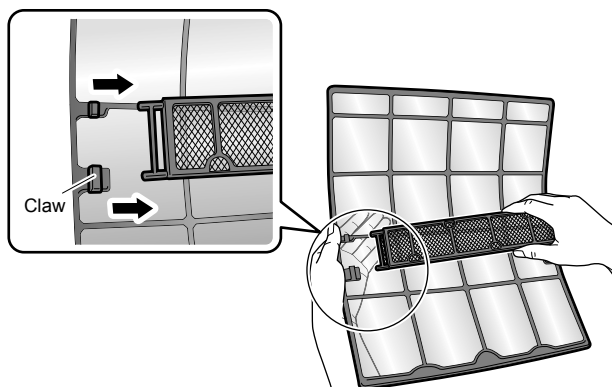

4. Clean or replace each filters.

5. Set the filters as they were and close the front panel.

- Press the front panel at both sides and the central area.

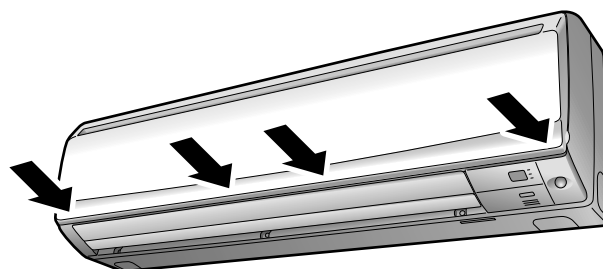

⚠ CAUTION

- Do not touch the aluminum fins by bare hand at the time of dismantling or mounting the filter.

Air filter

Wash the air filters with water or clean them with vacuum cleaner.

- If the dust does not come off easily, wash them with neutral detergent thinned with lukewarm water, then dry them up in the shade.
- It is recommended to clean the air filters every 2 weeks.

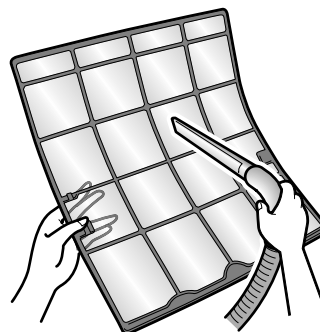

Titanium apatite photocatalytic air-purifying filter

The titanium apatite photocatalytic air-purifying filter can be renewed by washing it with water once every 6 months.

We recommend replacing it once every 3 years.

[Maintenance]

1. Vacuum dusts, and soak in warm water or water for about 10 to 15 minutes if dirt is heavy.

- Do not remove the filter from frame when washing with water.

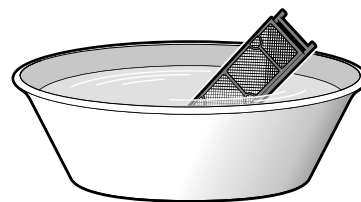

2. After washing, shake off remaining water and dry in the shade.

- Since the material is made out of polyester, do not wring out the filter when removing water from it.

[Replacement]

1. Remove the tabs on the filter frame and replace with a new filter.

- Dispose of the old filter as non-flammable waste.

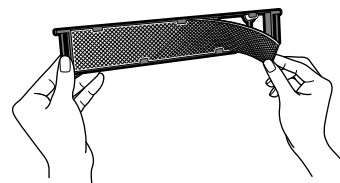

Care and Cleaning

NOTE

- Operation with dirty filters:
 - 1) cannot deodorize the air.
 - 2) cannot clean the air.
 - 3) results in poor heating or cooling.
 - 4) may cause odor.
- To order titanium apatite photocatalytic air-purifying filter contact to the service shop there you purchased the air conditioner.
- Dispose of old filters as non-flammable waste.

Item	Part No.
Titanium apatite photocatalytic air-purifying filter (without frame) 1 set	KAF970A48

ATTENTION



- Do not throw away the filter frame. Reuse the filter frame when replacing the titanium apatite photocatalytic air-purifying filter.

CHECK

- Check that the base, stand and other fittings of the outdoor unit are not decayed or corroded.
- Check that nothing blocks the air inlets and the outlets of the indoor unit and the outdoor unit.
- Check that the drain comes smoothly out of the drain hose during COOL or DRY operation.
 - If no drain water is seen, water may be leaking from the indoor unit. Stop operation and consult the service shop if this is the case.

Before a long idle period.

1. Operate the “FAN only” for several hours on a nice day to dry out the inside.

- Press **MODE** and select “” operation.
- Press  and start the operation.

2. After operation stops, turn off the breaker for the room air conditioner.

3. Clean the air filters and set them again.

4. Take out batteries from the remote controller.

Troubleshooting

These cases are not troubles.

The following cases are not air conditioner troubles but have some reasons. You may just continue using it.

Case	Explanation
<p>Operation does not start soon.</p> <ul style="list-style-type: none"> • When ON/OFF button was pressed soon after operation was stopped. • When the mode was reselected. 	<ul style="list-style-type: none"> • This is to protect the air conditioner. You should wait for about 3 minutes.
<p>Hot air does not flow out soon after the start of heating operation.</p>	<ul style="list-style-type: none"> • The air conditioner is warming up. You should wait for 1 to 4 minutes. (The system is designed to start discharging air only after it has reached a certain temperature.)
<p>The HEAT operation stops suddenly and a flowing sound is heard.</p>	<ul style="list-style-type: none"> • The outdoor unit is taking away the frost. The HEAT operation starts after the frost on the outdoor unit is removed. You should wait for about 4 to 12 minutes.
<p>Possible sounds.</p>	<ul style="list-style-type: none"> ■ Flowing water <ul style="list-style-type: none"> • Generated because the refrigerant in the air conditioner is flowing. • This is a pumping sound of the water in the air conditioner it is heard when the water is pumped out from the air conditioner in cooling or drying operation. • The refrigerant flows in the air conditioner even if the air conditioner is not working when the indoor units in other rooms are in operation. ■ Blowing <ul style="list-style-type: none"> • Generated when the flow of the refrigerant in the air conditioner is switched over. ■ Ticking <ul style="list-style-type: none"> • Generated when the size of the air conditioner slightly expands or shrinks as a result of temperature changes. ■ Whistling <ul style="list-style-type: none"> • Generated when refrigerant flows during defrosting operation. ■ Clicking <ul style="list-style-type: none"> • Generated when the refrigerant control valves or the electrical parts operate. ■ Clopping <ul style="list-style-type: none"> • Heard from the inside of the air conditioner when the exhaust fan is activated while the room doors are closed. Open the window or turn off the exhaust fan.
<p>The outdoor unit emits water or steam.</p>	<ul style="list-style-type: none"> ■ In HEAT operation <ul style="list-style-type: none"> • The frost on the outdoor unit melts into water or steam when the air conditioner is in defrost operation. ■ In COOL or DRY operation <ul style="list-style-type: none"> • Moisture in the air condenses into water on the cool surface of outdoor unit piping and drips.
<p>Mist comes out of the indoor unit.</p>	<ul style="list-style-type: none"> ■ This happens when the air in the room is cooled into mist by the cold airflow during cooling operation. ■ This is because the air in the room is cooled by the heat exchanger and becomes mist during defrost operation.
<p>The indoor unit gives out odor.</p>	<ul style="list-style-type: none"> ■ This happens when smells of the room, furniture, or cigarettes are absorbed into the unit and discharged with the airflow. If this happens, have the indoor unit washed by a technician from the service shop where you purchased the air conditioner.

Troubleshooting

Case	Explanation
The outdoor fan rotates while the air conditioner is not in operation.	<ul style="list-style-type: none"> ■ After operation is stopped: <ul style="list-style-type: none"> • The outdoor fan continues rotating for another 60 seconds for system protection. ■ While the air conditioner is not in operation: <ul style="list-style-type: none"> • When the outdoor temperature is very high, the outdoor fan starts rotating for system protection.
The operation stopped suddenly. (OPERATION lamp is on.)	<ul style="list-style-type: none"> • For system protection, the air conditioner may stop operating on a sudden large voltage fluctuation. It automatically resumes operation in about 3 minutes.
No remote controller signals are displayed. The remote controller sensitivity is low. The display is low in contrast or blacked out. The display runs out of control.	<ul style="list-style-type: none"> • The batteries are dying and the remote controller is malfunctioning. Replace all the batteries with new size batteries, AAA.LR03 (alkaline). For details, refer to set the batteries of this manual. ▶Page 8
The ON/OFF TIMER does not operate according to the settings.	<ul style="list-style-type: none"> • Check if the ON/OFF TIMER and the WEEKLY TIMER are set to the same time. Change or disable the settings in the WEEKLY TIMER. ▶Page 23

Check again.

Please check again before calling a repair person.

Case	Check
The air conditioner does not operate. (OPERATION lamp is off.)	<ul style="list-style-type: none"> • Is a breaker off or a fuse blown? • Is there a power failure? • Are batteries set in the remote controller? • Is the timer setting correct?
Cooling (Heating) effect is poor.	<ul style="list-style-type: none"> • Are the air filters clean? • Is there anything to block the air inlet or the outlet of the indoor and the outdoor units? • Is the temperature setting appropriate? • Are the windows and doors closed? • Are the airflow rate and the air direction set appropriately? • Is the air conditioner in ECONO operation or OUTDOOR UNIT QUIET operation?
Operation stops suddenly. (OPERATION lamp flashes.)	<ul style="list-style-type: none"> • Are the air filters clean? Clean the air filters. • Is there anything to block the air inlet or the outlet of the indoor and the outdoor units? • Turn the breaker off and take all obstacles away. Then turn it on again and try operating the air conditioner with the remote controller. If the lamp still flashes, call the service shop where you purchased the air conditioner.
An abnormal functioning happens during operation.	<ul style="list-style-type: none"> • The air conditioner may malfunction with lightning or radio waves. Turn the breaker off, turn it on again and try operating the air conditioner with the remote controller.
The flap does not start swinging immediately.	<ul style="list-style-type: none"> • The air conditioner is adjusting the flap position. The flap will start moving soon.
HEAT operation cannot be selected, even though the unit is heat pump model.	<ul style="list-style-type: none"> • Slide the DIP switch to the left as shown in the illustration so that the HEAT operation can be selected with the "MODE" button.

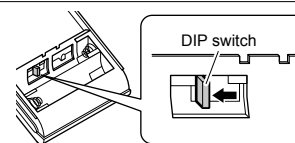

■ Call the service shop immediately.

WARNING

- **When an abnormality (such as a burning smell) occurs, stop operation and turn the breaker off.**
 - Continued operation in an abnormal condition may result in malfunctioning, electric shocks or fire.
 - Consult the service shop where you purchased the air conditioner.
- **Do not attempt to repair or modify the air conditioner by yourself.**
 - Incorrect work may result in electric shocks or fire.
 - Consult the service shop where you purchased the air conditioner.

If one of the following symptoms occurs, call the service shop immediately.

- The power cord is abnormally hot or damaged.
- An abnormal sound is heard during operation.
- The safety breaker, a fuse, or the earth leakage breaker cuts off the operation frequently.
- A switch or a button often fails to work properly.
- There is a burning smell.
- Water leaks from the indoor unit.

Turn the breaker off and call the service shop.



■ After a power failure

- The air conditioner automatically resumes operation in about 3 minutes. You should just wait for a while.

■ Lightning

- If lightning may strike the neighboring area, stop operation and turn the breaker off for system protection.

■ We recommend periodical maintenance.

- In certain operating conditions, the inside of the air conditioner may get foul after several seasons of use, resulting in poor performance. It is recommended to have periodic maintenance by a specialist aside from regular cleaning by the user.
- For specialist maintenance, contact the service shop where you purchased the air conditioner.
- The maintenance cost must be born by the user.

Troubleshooting

Fault diagnosis.

FAULT DIAGNOSIS BY REMOTE CONTROLLER

In the ARC452A series, the temperature display sections on the main unit indicate corresponding codes.

1. When the **TIMER CANCEL** button is held down for 5 seconds, a “00” indication flashes on the temperature display section.

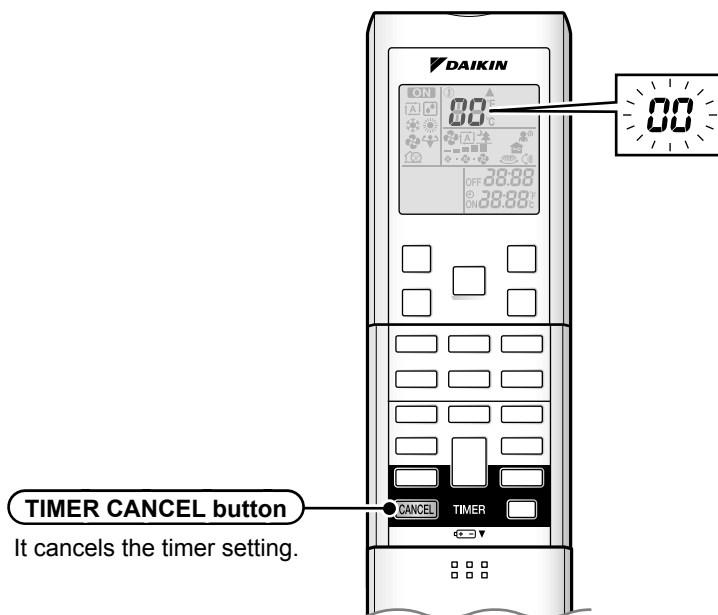

2. Press the **TIMER CANCEL** button repeatedly until a continuous beep is produced.

- The code indication changes as shown below, and notifies with a long beep.

	CODE	MEANING
SYSTEM	00	NORMAL
	U0	REFRIGERANT SHORTAGE
	U2	DROP VOLTAGE OR MAIN CIRCUIT OVERVOLTAGE
	U4	FAILURE OF TRANSMISSION (BETWEEN INDOOR UNIT AND OUTDOOR UNIT)
INDOOR UNIT	A1	INDOOR PCB DEFECTIVENESS
	A5	HIGH PRESSURE CONTROL OR FREEZE-UP PROTECTOR
	A6	FAN MOTOR FAULT
	C4	FAULTY HEAT EXCHANGER TEMPERATURE SENSOR
	C9	FAULTY SUCTION AIR TEMPERATURE SENSOR
OUTDOOR UNIT	EA	COOLING-HEATING SWITCHING ERROR
	E5	OL STARTED
	E6	FAULTY COMPRESSOR START UP
	E7	DC FAN MOTOR FAULT
	E8	OPERATION HALT DUE TO DETECTION OF INPUT OVER CURRENT
	F3	HIGH TEMPERATURE DISCHARGE PIPE CONTROL
	H6	OPERATION HALT DUE TO FAULTY POSITION DETECTION SENSOR
	H8	CT ABNORMALITY
	H9	FAULTY SUCTION AIR TEMPERATURE SENSOR
	J3	FAULTY DISCHARGE PIPE TEMPERATURE SENSOR
	J6	FAULTY HEAT EXCHANGER TEMPERATURE SENSOR
	L4	HIGH TEMPERATURE AT INVERTER CIRCUIT HEATSINK
	L5	OUTPUT OVERCURRENT
P4	FAULTY INVERTER CIRCUIT HEATSINK TEMPERATURE SENSOR	

NOTE

- A short beep and two consecutive beeps indicate non-corresponding codes.
- To cancel the code display, hold the **TIMER CANCEL** button down for 5 seconds. The code display also cancel itself if the button is not pressed for 1 minute.

DAIKIN AC (AMERICAS), INC.

1645 Wallace Drive, Suite 110
Carrollton, TX75006

info@daikinac.com
www.daikinac.com

DAIKIN INDUSTRIES, LTD.

Head office:

Umeda Center Bldg., 2-4-12, Nakazaki-Nishi,
Kita-ku, Osaka, 530-8323 Japan

Tokyo office:

JR Shinagawa East Bldg., 2-18-1, Konan,
Minato-ku, Tokyo, 108-0075 Japan



Two-dimensional bar code is a code for manufacturing.

3P228444-4K M10B280B (1304) HT