

**DAIKIN**

English

Français

Español

DAIKIN ROOM AIR CONDITIONER

# OPERATION MANUAL



Enjoy year-round comfort.

## MODELS

CTXG09QVJUW

CTXG12QVJUW

CTXG18QVJUW

CTXG09QVJUS

CTXG12QVJUS

CTXG18QVJUS

FTXR09TVJUW

FTXR12TVJUW

FTXR18TVJUW

FTXR09TVJUS

FTXR12TVJUS

FTXR18TVJUS

# Features

## Enhanced comfort and energy savings



### INTELLIGENT EYE

The INTELLIGENT EYE sensor detects human movement in a room. If no one is in the room for more than 20 minutes, the operation automatically changes to energy saving operation.

▶ Page 14



### WEEKLY TIMER

Up to 4 timer settings can be saved for each day of the week according to your family's life style. The WEEKLY TIMER allows you to set on/off times and the desired temperature. ▶ Page 21

## Other functions



### COMFORT AIRFLOW

The airflow direction is upward while in COOL operation, and downward while in HEAT operation. This function prevents cold or warm air from blowing directly on your body. ▶ Page 14



### OUTDOOR UNIT QUIET

OUTDOOR UNIT QUIET operation assures a low noise level of the outdoor unit. This function is useful to maintain a quiet neighborhood.



▶ Page 18

# Contents



## ■ Read Before Operation

|                                    |   |
|------------------------------------|---|
| Safety Considerations.....         | 3 |
| Names of Parts .....               | 5 |
| Preparation Before Operation ..... | 9 |



## ■ Basic Operation

|   |    |
|---|----|
|  AUTO · DRY · COOL · HEAT · FAN<br>Operation ..... | 11 |
|  Adjusting the Airflow Rate.....                   | 12 |
|  Adjusting the Airflow Direction .....             | 13 |

## ■ Useful Functions

|  |    |
|--|----|
|  COMFORT AIRFLOW /<br>INTELLIGENT EYE Operation..... | 14 |
|  POWERFUL Operation.....                            | 17 |
|  ECONO / OUTDOOR UNIT QUIET<br>Operation .....      | 18 |

## ■ TIMER Operation

|  |    |
|--|----|
|  ON/OFF TIMER Operation ..... | 19 |
|  WEEKLY TIMER Operation.....  | 21 |

## ■ Multi Connection

|                             |    |
|-----------------------------|----|
| Note for Multi System ..... | 27 |
|-----------------------------|----|

## ■ Care

|                        |    |
|------------------------|----|
| Care and Cleaning..... | 29 |
|------------------------|----|

## ■ When the Need Arises

|                       |    |
|-----------------------|----|
| FAQ.....              | 33 |
| Troubleshooting ..... | 34 |



### ECONO

This function enables efficient operation by limiting the maximum power consumption. It is useful when using the air conditioner and other electrical devices simultaneously on a shared electrical circuit. ▶Page 18

# Safety Considerations

Read these **Safety Considerations for Operations** carefully before operating an air conditioner or heat pump.

Make sure that the unit operates properly during the startup operation. Instruct the user on how to operate and maintain the unit.

Inform users that they should store this operation manual with the installation manual for future reference.

Meanings of **DANGER**, **WARNING**, **CAUTION**, and **NOTE** Symbols:

 **DANGER** ..... Indicates an imminently hazardous situation which, if not avoided, will result in death or serious injury.

 **WARNING** ..... Indicates a potentially hazardous situation which, if not avoided, could result in death or serious injury.

 **CAUTION** ..... Indicates a potentially hazardous situation which, if not avoided, may result in minor or moderate injury. It may also be used to alert against unsafe practices.

 **NOTE** ..... Indicates situations that may result in equipment or property-damage accidents only.

## **DANGER**

- Do not install the unit in an area where flammable materials are present due to risk of explosion resulting in serious injury or death.
- Any abnormalities in the operation of the air conditioner or heat pump, such as smoke or fire, could result in severe injury or death. Turn off the power and contact your dealer immediately.
- Refrigerant gas may produce toxic gas if it comes into contact with fire, such as from a fan heater, stove, or cooking device. Exposure to this gas could cause severe injury or death.
- For refrigerant leakage, consult your dealer. Refrigerant gas is heavier than air and replaces oxygen. A massive leak could lead to oxygen depletion, especially in basements, and an asphyxiation hazard could occur leading to serious injury or death.
- If equipment utilizing a burner is used in the same room as the air conditioner or heat pump, there is the danger of oxygen deficiency which could lead to an asphyxiation hazard resulting in serious injury or death. Be sure to ventilate the room sufficiently to avoid this hazard.
- Safely dispose of the packing materials. Packing materials, such as nails and other metal or wooden parts, may cause stabs or other injuries.
- Tear apart and throw away plastic packaging bags so that children will not play with them. Children playing with plastic bags face the danger of death by suffocation.

## **WARNING**

- Contact your dealer for repair and maintenance. Improper repair and maintenance may result in water leakage, electric shock, and fire. Only use accessories made by Daikin that are specifically designed for use with the equipment and have them installed by a professional.
- Contact your dealer to move and reinstall the air conditioner or heat pump. Incomplete installation may result in water leakage, electric shock, and fire.
- Never let the indoor unit or the remote controller get wet. Water can cause an electric shock or a fire.
- Never use flammable spray such as hair spray, lacquer, or paint near the unit. Flammable spray may cause a fire.
- When a fuse blows out, never replace it with one of incorrect ampere ratings or different wires. Always replace any blown fuse with a fuse of the same specification.
- Never remove the fan guard of the unit. A fan rotating at high speed without the fan guard is very dangerous.
- Never inspect or service the unit by yourself. Contact a qualified service person to perform this work.
- Turn off all electrical power before doing any maintenance to avoid the risk of serious electric shock; never sprinkle or spill water or liquids on the unit.
- Do not touch the switch with wet fingers. Touching a switch with wet fingers can cause electric shock.
- Do not allow children to play on or around the unit to prevent injury.
- The heat exchanger fins are sharp enough to cut. To avoid injury wear gloves or cover the fins while working around them.
- Do not put a finger or other objects into the air inlet or air outlet. The fan is rotating at high speed and will cause injury.
- Check the unit foundation for damage on a continuous basis, especially if it has been in use for a long time. If left in a damaged condition the unit may fall and cause injury.
- Placing a flower vase or other containers with water or other liquids on the unit could cause a shock or fire if a spill occurs.
- Do not touch the air outlet or horizontal blades while the swing flap is in operation because fingers could get caught and injured.
- Never touch the internal parts of the controller. Do not remove the front panel because some parts inside are dangerous to touch. To check and adjust internal parts, contact your dealer.

## **CAUTION**

- Do not use the air conditioner or heat pump for any other purposes other than comfort cooling or heating. Do not use the unit for cooling precision instruments, food, plants, animals or works of art.

- Do not place items under the indoor unit as they may be damaged by condensates that may form if the humidity is above 80% or if the drain outlet gets blocked.
- Before cleaning, stop the operation of the unit by turning the power off or by pulling the supply cord out from its receptacle. Otherwise, an electric shock and injury may result.
- Do not wash the air conditioner or heat pump with excessive water. An electric shock or fire may result.
- Avoid placing the controller in a spot splashed with water. Water entering the controller may cause an electric shock or damage the internal electronic parts.
- Do not operate the air conditioner or heat pump when using a room-fumigation type of insecticide. Failure to observe this could cause the chemicals to be deposited in the unit and can endanger the health of those who are hypersensitive to chemicals.
- Do not turn off the power immediately after stopping operation. Always wait for at least 5 minutes before turning off the power. Otherwise, water leakage may occur.
- The appliance is not intended for use by young children or infirm persons without supervision.
- The remote controller should be kept away from children so they cannot play with it.
- Consult with the installation contractor for cleaning.
- Incorrect cleaning of the inside of the air conditioner or heat pump could make the plastics parts break and cause water leakage or electric shock.
- Do not touch the air inlet or aluminum fin of the air conditioner or heat pump as they can cut and cause injury.
- Do not place objects in direct proximity of the outdoor unit. Do not let leaves and other debris accumulate around the unit. Leaves are a hotbed for small animals which can enter the unit. Once inside the unit, animals can cause the unit to malfunction, and cause smoke or fire when they make contact with electrical parts.
- Do not wipe the controller operation panel with benzene, thinner, chemical dust cloth, etc. The panel may get discolored or the coating can peel off. If it is heavily dirty, soak a cloth in water-diluted neutral detergent, squeeze it well and wipe the panel clean. Then wipe it with another dry cloth.
- Dismantling of the unit, disposal of the refrigerant, oil, and additional parts, shall be done in accordance with the relevant local, state, and national regulations.
- Operate the air conditioner or heat pump in a sufficiently ventilated area and not surrounded by obstacles. Do not use the air conditioner or heat pump in the following places.
  - a. Places with a mist of mineral oil, such as cutting oil.
  - b. Locations such as coastal areas where there is a lot of salt in the air.
  - c. Locations such as hot springs where there is a lot of sulfur in the air.
  - d. Locations such as factories where the power voltage varies a lot.
  - e. In cars, boats, and other vehicles.
  - f. Locations such as kitchens where oil may splatter or where there is steam in the air.
  - g. Locations where equipment produces electromagnetic waves.
  - h. Places with an acid or alkaline mist.
  - i. Places where fallen leaves can accumulate or where weeds can grow.
- Take snow protection measures. Contact your dealer for the details of snow protection measures, such as the use of a snow protection hood.
- Do not attempt to do electrical work or grounding work unless you are licensed to do so. Consult with your dealer for electrical work and grounding work.
- Pay attention to operating sound. Be sure to use the following places:
  - a. Places that can sufficiently withstand the weight of the air conditioner or heat pump yet can suppress the operating sound and vibration.
  - b. Places where warm air from the air outlet of the outdoor unit or the operating sound of the outdoor unit does not annoy neighbors.

---

**NOTE**

---

- Never press the button of the remote controller with a hard, pointed object. The remote controller may be damaged.
- Never pull or twist the electric wire of the remote controller. It may cause the unit to malfunction.
- Do not place appliances that produce open flames in places that are exposed to the airflow of the unit or under the indoor unit. It may cause incomplete combustion or deformation of the unit due to the heat.
- Do not expose the controller to direct sunlight. The LCD display can become discolored and may fail to display the data.
- Make sure that there are no obstacles close to the outdoor unit. Obstacles close to the outdoor unit may drop the performance of the outdoor unit or increase the operating sound of the outdoor unit.
- Consult your dealer if the air conditioner or heat pump in operation generates unusual noise.
- Make sure that the drainpipe is installed properly to drain water. If no water is discharged from the drainpipe while the air conditioner or heat pump is in the cooling mode, the drainpipe may be clogged with dust or dirt and water leakage from the indoor unit may occur. Stop operating the air conditioner or heat pump and contact your dealer.

FTP001-U

# Names of Parts

## Indoor Unit

• Appearance of the indoor unit may differ.

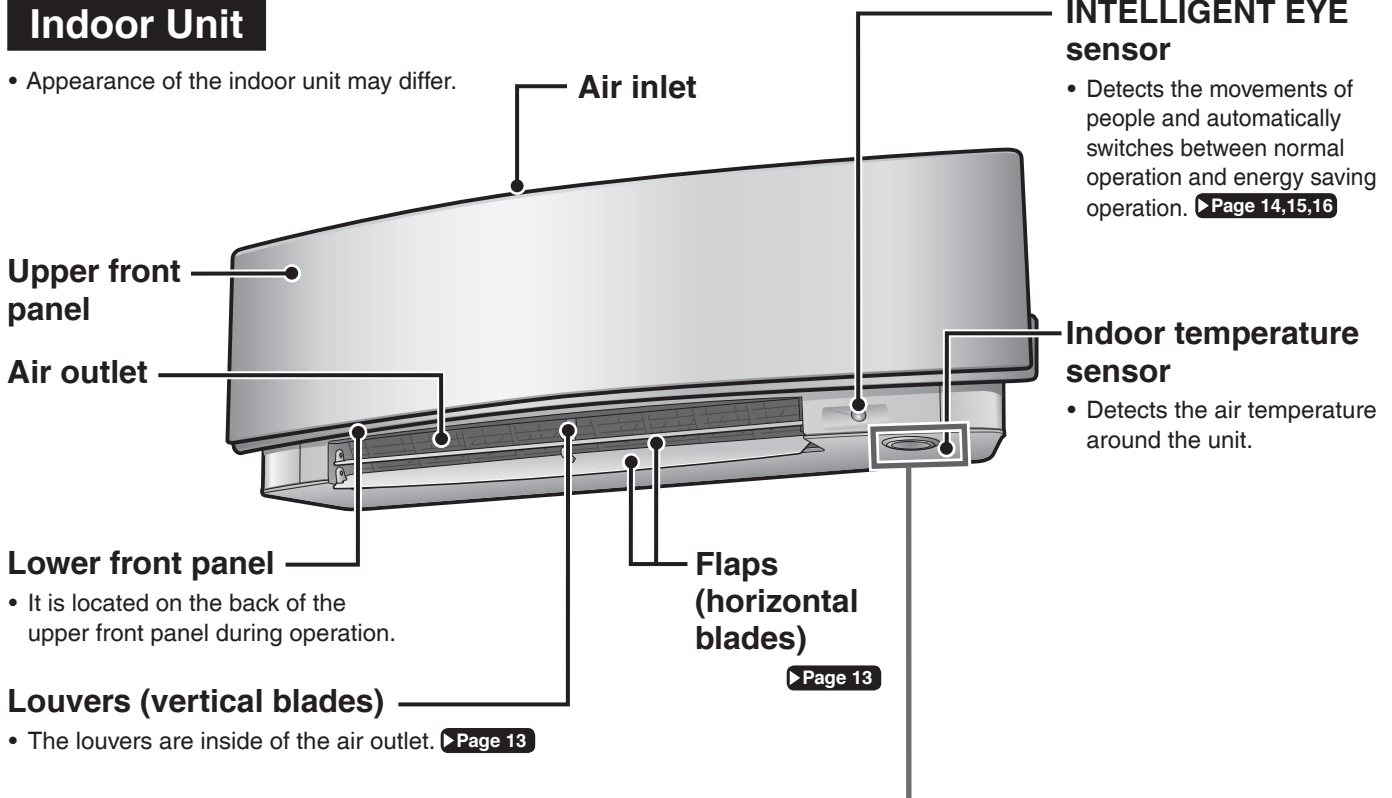

**INTELLIGENT EYE sensor**

- Detects the movements of people and automatically switches between normal operation and energy saving operation. ▶Page 14,15,16

**Indoor temperature sensor**

- Detects the air temperature around the unit.

**Upper front panel**

**Air outlet**

**Lower front panel**

- It is located on the back of the upper front panel during operation.

**Louvers (vertical blades)**

- The louvers are inside of the air outlet. ▶Page 13

**Flaps (horizontal blades)**

▶Page 13

## Display

### Multi-monitor lamp and TIMER lamp

#### Multi-monitor lamp

- The lamp color changes according to the operation.

| Operation | Multi-monitor lamp |
|-----------|--------------------|
| AUTO      | Red/Blue           |
| DRY       | Green              |
| COOL      | Blue               |
| HEAT      | Red                |
| FAN       | White              |
| TIMER     | Orange             |

#### TIMER lamp

- When operation by timer has been set, the multi-monitor lamp periodically changes to orange. After lighting orange for about 5 seconds, it returns to the color of the operation mode. The multi-monitor lamp will turn orange on and off in cyclic manner while the air conditioner is not in operation.

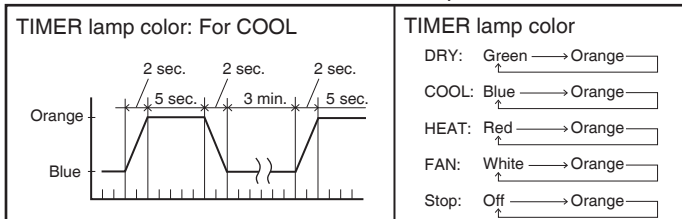

### INTELLIGENT EYE lamp (green) ▶Page 15

#### Signal receiver and Indoor unit ON/OFF switch

##### Signal receiver

- Receives signals from the remote controller.
- When the unit receives a signal, you will hear a beep sound.

| Case            | Sound type |
|-----------------|------------|
| Operation start | beep-beep  |
| Setting changed | beep       |
| Operation stop  | long beep  |

#### Indoor unit ON/OFF switch

- Press this switch once to start operation. Press once again to stop it.
- For the operation mode setting, refer to the following table.

| Mode | Temperature setting | Airflow rate |
|------|---------------------|--------------|
| AUTO | 77°F (25°C)         | AUTO         |

- This switch can be used when the remote controller is missing.

■ Open the upper front panel

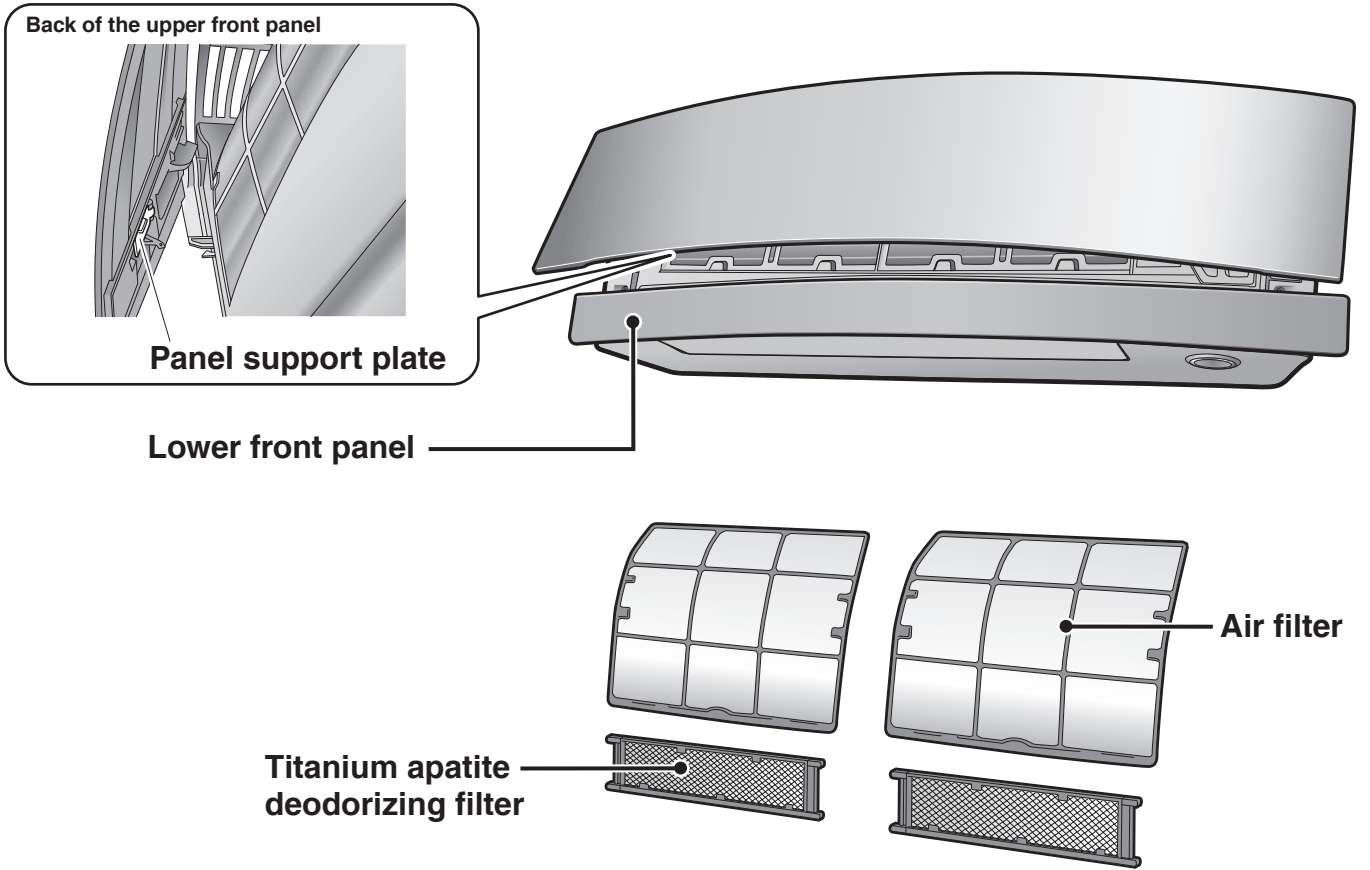

**Outdoor Unit**

- The appearance of the outdoor unit may differ between different models.

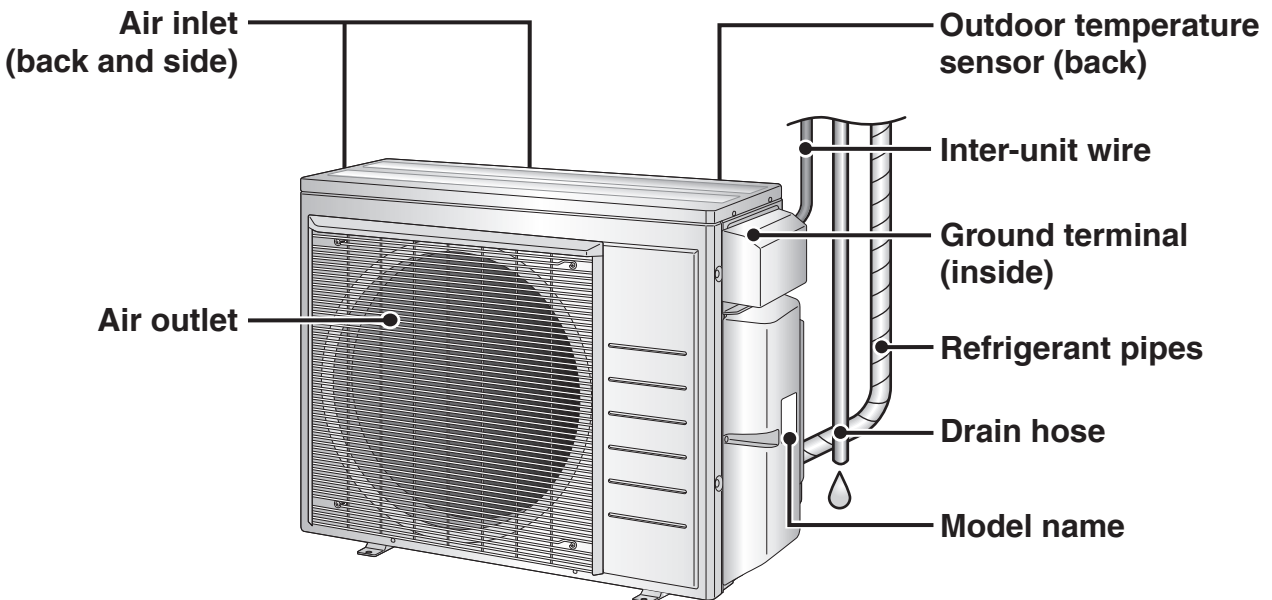

# Names of Parts

## Remote Controller

### Signal transmitter

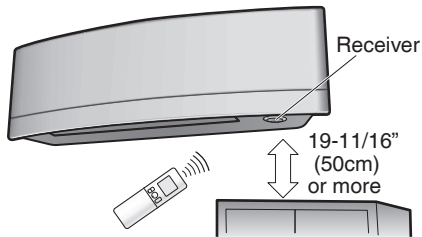

- To use the remote controller, aim the transmitter at the indoor unit. If there is anything blocking the signals between the unit and the remote controller, such as a curtain, the unit may not operate.
- The maximum transmission distance is about 19-11/16ft (6m).  
Make sure that there are no obstacles within 19-11/16 inch (50cm) under the signal receiver.  
Such obstacles, if any, may have an adverse influence on the reception performance of the receiver and the reception distance may be shortened.

### FAN setting button

- Selects the airflow rate setting. [▶ Page 12](#)

### POWERFUL button

- POWERFUL operation. [▶ Page 17](#)

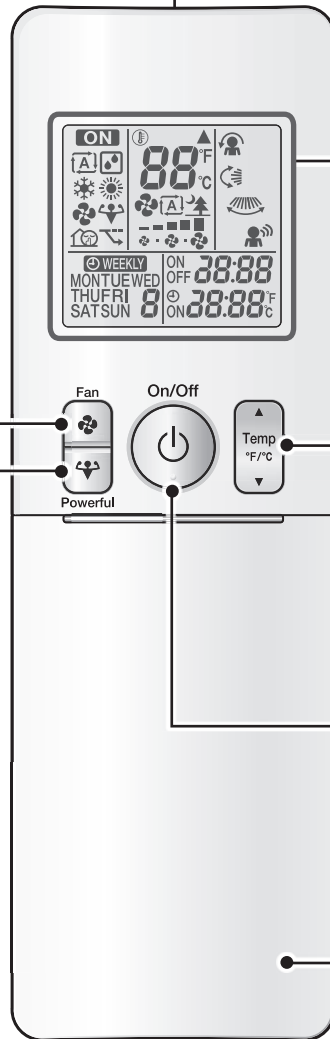

### Display (LCD)

- Displays the current settings. (In this illustration, each section is shown with all its displays on for the purpose of explanation.)

### TEMPERATURE adjustment button

- Changes the temperature setting. [▶ Page 11](#)

### ON/OFF button

- Press this button once to start operation.  
Press once again to stop it. [▶ Page 11](#)

### Front cover

- Open the front cover. [▶ Page 8](#)

|       |           |
|-------|-----------|
| Model | ARC466A36 |
|-------|-----------|



■ Open the front cover

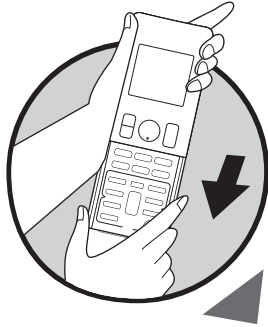

**MODE selector button**

- Selects the operation mode. (AUTO/DRY/COOL/HEAT/FAN) ▶Page 11

**ECONO/QUIET button**

- ECONO/OUTDOOR UNIT QUIET operation. ▶Page 18

**SWING button**

- Adjusts the airflow direction. ▶Page 13

Weekly : WEEKLY button

◊ : PROGRAM button

Copy : COPY button

Back : BACK button

Next : NEXT button

- WEEKLY TIMER operation. ▶Page 21

**ON TIMER button**

▶Page 19

**CLOCK button** ▶Page 10

**Lamp brightness setting button**

▶Page 10

**COMFORT/SENSOR button**

- COMFORT AIRFLOW and INTELLIGENT EYE operation. ▶Page 14

**OFF TIMER button (NIGHT SET mode)**

▶Page 20

**TIMER CANCEL button**

- Cancels the timer setting. ▶Page 19,20
- Cannot be used for the WEEKLY TIMER operation.

**SELECT button**

- Changes the clock, ON/OFF TIMER and WEEKLY TIMER settings.

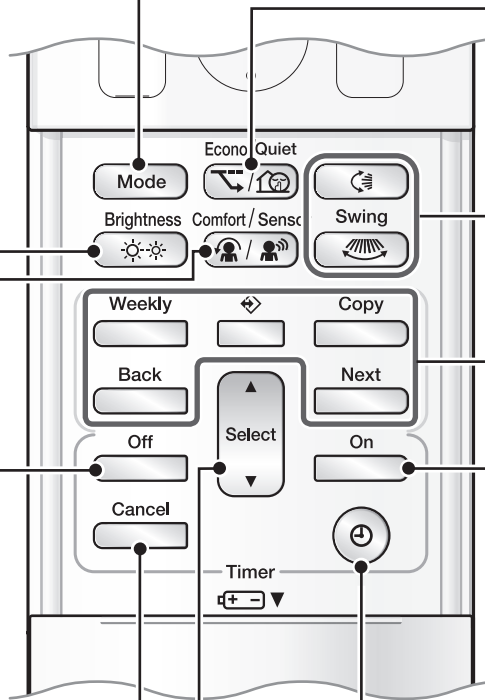

# Preparation Before Operation

## CAUTION

Incorrect handling of batteries can result in injury from battery leakage, rupturing or heating, or lead to equipment failure.

Please observe the following precautions and use safely.

- If the alkaline solution from the batteries should get in the eyes, do not rub the eyes. Instead, immediately flush the eyes with tap water and seek the attention of a medical professional.
- Keep batteries out of reach of children. In the event that batteries are swallowed, seek the immediate attention of a medical professional.
- Do not expose batteries to heat or fire. Do not disassemble or modify batteries. The insulation or gas release vent inside the battery may be damaged, resulting in battery leakage, rupturing, or heating.
- Do not damage or peel off labels on the batteries.

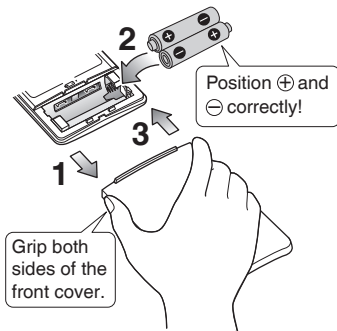

### To insert the batteries

1. Slide the front cover to take it off.
2. Insert 2 dry batteries AAA.LR03 (alkaline).
3. Replace the front cover.

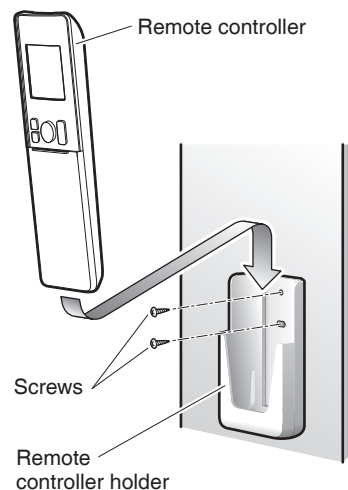



### To attach the remote controller holder to a wall

1. Choose a place where the signals reach the unit.
2. Attach the holder to a wall, a pillar, or similar location with the screws supplied with the holder.
3. Place the remote controller in the remote controller holder.

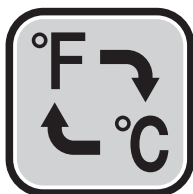
### Fahrenheit/Celsius display switch



Press  and  (TIMER button) simultaneously for about 5 seconds.

- The temperature will be displayed in Celsius when it is presently displayed in Fahrenheit, and vice versa.
- The switch operation is only possible when the temperature is being displayed.

## NOTE

### Notes on batteries

- To avoid possible injury or damage from battery leakage or rupturing, remove the batteries when not using the product for long periods of time.
- The standard replacement time is about 1 year. Both batteries should be replaced at the same time. Be sure to replace them with new size AAA.LR03 (alkaline) batteries. However, if the remote controller display begins to fade and the possible transmission range becomes shorter within a year, replace both batteries as specified above.
- The batteries supplied with the remote controller are for initial operation. The batteries may run out in less than 1 year.

### Note on remote controller

- Do not drop the remote controller. Do not get it wet.

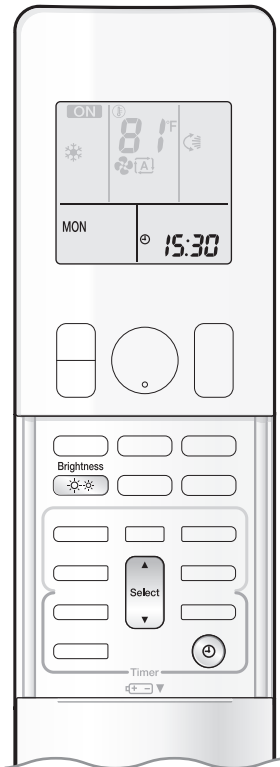

## Turn on the circuit breaker

- After the power is turned on, the flaps of the indoor unit open and close once to set the reference position.

## To set the luminance of the display

- The luminance of the indoor unit display can be set.

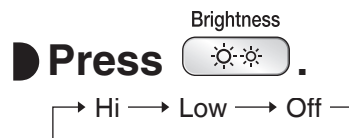

## To set the clock

### 1. Press .

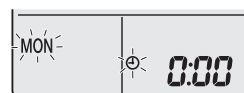

“0:00” is displayed on the LCD.  
“MON” and “⌚” blink.

### 2. Press to set the current day of the week.

### 3. Press .



“⌚” blinks.

### 4. Press to set the clock to the present time.

- Holding down ▲ or ▼ rapidly increases or decreases the displayed time.

### 5. Press .

- Point the remote controller at the indoor unit when pressing the buttons.



“.” blinks.

## NOTE

### Fahrenheit/Celsius display change function of remote controller

- The set temperature may increase when the display is changed to Celsius from Fahrenheit, because a fraction of 0.5°C is rounded up.
- Example: A set temperature of 65°F (equivalent to 18.5°C) will be converted into 19°C.  
When the display is changed to Fahrenheit again, the set temperature will be converted into 66°F (equivalent to 19°C) instead of the original set temperature (65°F) but a set temperature of 66°F (equivalent to 19°C) will be converted into 19°C with no temperature change.
- A reception sound will go off for the transmission of set temperature to the indoor unit at the time of setting the Fahrenheit/Celsius display change function.

### Note on setting the clock

- If the indoor unit's internal clock is not set to the correct time, the ON/OFF TIMER and WEEKLY TIMER will not operate punctually.



# AUTO · DRY · COOL · HEAT · FAN Operation

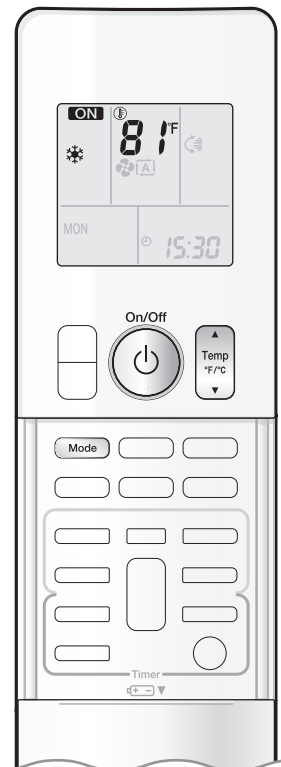

The air conditioner operates with the operation mode of your choice. From the next time on, the air conditioner will operate with the same operation mode.

## To start operation

### 1. Press and select an operation mode.

- Each pressing of the button changes the mode setting in sequence.

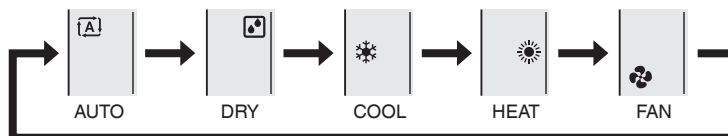

### 2. Press .

- “**ON**” is displayed on the LCD.
- The multi-monitor lamp lights up. The color of the lamp varies depending on the operation mode.

| Operation | Multi-monitor lamp |
|-----------|--------------------|
| AUTO      | Red/Blue           |
| DRY       | Green              |
| COOL      | Blue               |
| HEAT      | Red                |
| FAN       | White              |



Display

## To stop operation

### Press again.

- “**ON**” disappears from the LCD.
- The multi-monitor lamp goes off.

## To change the temperature setting

### Press .

- Press ▲ to raise the temperature and press ▼ to lower the temperature.

| COOL operation       | HEAT operation       | AUTO operation       | DRY or FAN operation                       |
|----------------------|----------------------|----------------------|--|
| 64-90°F<br>(18-32°C) | 50-86°F<br>(10-30°C) | 64-86°F<br>(18-30°C) | The temperature setting cannot be changed. |

## NOTE

### Notes on AUTO operation

- In AUTO operation, the system selects an appropriate operation mode (COOL or HEAT) based on the indoor temperature and starts the operation.
- The system automatically reselects setting at a regular interval to bring the indoor temperature to the user-setting level.

### Note on DRY operation

- Eliminates humidity while maintaining the indoor temperature as much as possible. It automatically controls temperature and airflow rate, so manual adjustment of these functions is unavailable.



# Adjusting the Airflow Rate

You can adjust the airflow rate to increase your comfort.

## To adjust the airflow rate setting

Press .

- Each pressing of  changes the airflow rate setting in sequence.

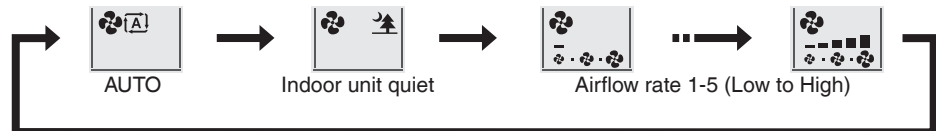

- When the airflow is set to “”, quiet operation starts and noise from the indoor unit will become quieter.
- In the quiet operation mode, the airflow rate is set to a weak level.
- In DRY operation, the airflow rate setting cannot be changed.

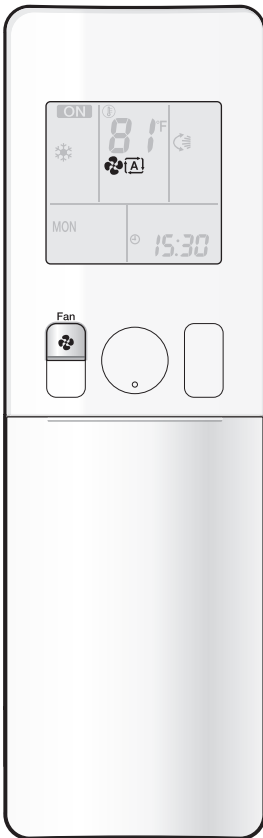

## NOTE

### Note on airflow rate setting

- At smaller airflow rates, the cooling (heating) effect is also smaller.

## Tips for saving energy

### Keeping the temperature setting at a moderate level helps save energy.

- Recommended temperature setting
  - For cooling: 78-82°F (26-28°C)
  - For heating: 68-75°F (20-24°C)

### Cover windows with a blind or a curtain.

- Blocking sunlight and air from outdoors increases the cooling (heating) effect.

### Keep the air filter clean.

- Clogged air filters cause inefficient operation and waste energy. Clean them once in about every 2 weeks. [▶ Page 30](#)

### If you are not going to use the air conditioner for a long period, for example in spring or autumn, turn off the circuit breaker.

- The air conditioner always consumes a small amount of electricity even while it is not operating.





# Adjusting the Airflow Direction

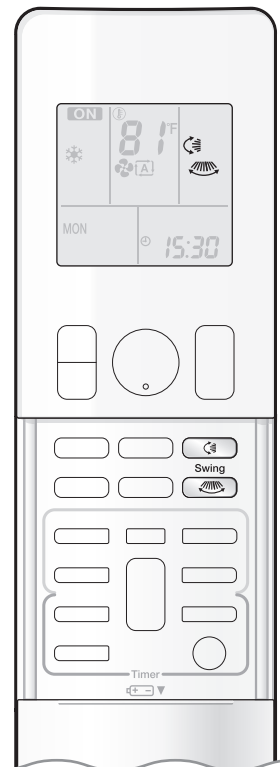

You can adjust the airflow direction to increase your comfort.

## ⚠ CAUTION

- Always use a remote controller to adjust the angles of the flaps and louvers.
  - If you attempt to move the flaps and louvers forcibly by hand when they are swinging, the mechanism may be damaged.
  - Inside the air outlet, a fan is rotating at a high speed.

### To start auto swing

#### Up and down airflow direction

▶ Press  .

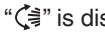
- “” is displayed on the LCD.
- The flaps (horizontal blades) will begin to swing.

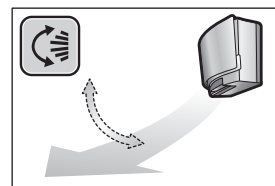

#### Right and left airflow direction



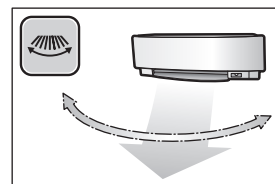

▶ Press  .

- “” is displayed on the LCD.
- The louvers (vertical blades) will begin to swing.

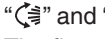

#### The 3-D airflow direction

▶ Press  and  .

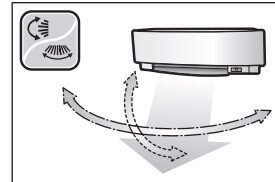

- “” and “” are displayed on the LCD.
- The flaps and louvers move in turn.
- To cancel 3-D airflow, press either  or  again. The flaps or louvers will stop moving.



### To set the flaps or louvers at the desired position

- This function is effective while the flaps or louvers are in auto swing mode.

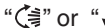
▶ Press  and  when the flaps or louvers reach the desired position.

- In the 3-D airflow, the flaps and louvers move in turn.
- “” or “” disappears from the LCD.

## NOTE

### Notes on airflow direction setting

- The movable range of the flaps varies according to the operation mode.
- The flaps will stop at the upper position when the airflow rate is changed to low during the up and down swing setting.

### Note on 3-D airflow

- Using 3-D airflow circulates cold air, which tends to be collected at the bottom of the room, and hot air, which tends to collect near the ceiling, throughout the room, preventing areas of cold and hot developing.

Movable range of the flaps

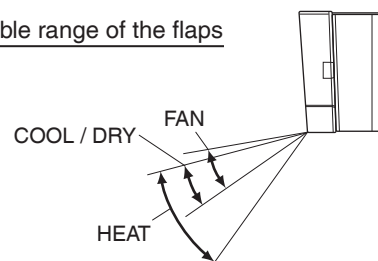



# COMFORT AIRFLOW / INTELLIGENT EYE Operation

**COMFORT AIRFLOW operation:** The airflow direction is upward while in COOL operation, and downward while in HEAT operation. This function prevents cold or warm air from blowing directly on the occupants in the room.

**INTELLIGENT EYE operation:** The INTELLIGENT EYE sensor detects human movement and adjusts the right and left airflow direction to avoid blowing air directly on the person. If no one is in the room for more than 20 minutes, the operation automatically changes to energy saving operation. The INTELLIGENT EYE sensor works differently depending on the situation.

## INTELLIGENT EYE operation is useful for energy saving

### ■ A person is detected in area 1.

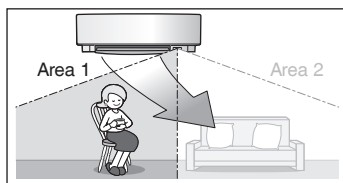

### ■ A person is detected in area 2.

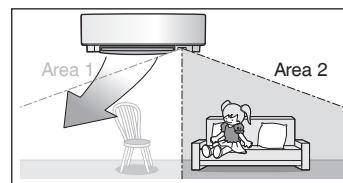

### ■ People are detected in both areas.

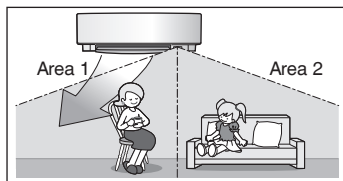

### ■ No people are detected in the areas.

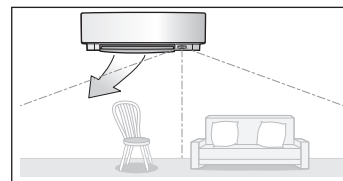

Use the INTELLIGENT EYE operation in combination with the COMFORT AIRFLOW operation.

The air conditioner will switch to energy saving mode after 20 minutes.

\*The airflow direction may differ from the illustrated direction depending on the actions and movements of the people in the areas.

### Energy saving operation

- If no presence is detected in the room for 20 minutes, the energy saving operation will start, and the INTELLIGENT EYE lamp goes off.
- This operation changes the temperature by  $-3.6^{\circ}\text{F}$  ( $-2^{\circ}\text{C}$ ) in HEAT /  $+3.6^{\circ}\text{F}$  ( $+2^{\circ}\text{C}$ ) in COOL /  $+3.6^{\circ}\text{F}$  ( $+2^{\circ}\text{C}$ ) in DRY operation from the set temperature.  
When the room temperature exceeds  $86^{\circ}\text{F}$  ( $30^{\circ}\text{C}$ ), the operation changes the temperature by  $+1.8^{\circ}\text{F}$  ( $+1^{\circ}\text{C}$ ) in COOL /  $+1.8^{\circ}\text{F}$  ( $+1^{\circ}\text{C}$ ) in DRY operation from the set temperature.
- This operation decreases the airflow rate slightly in FAN operation only.



# COMFORT AIRFLOW / INTELLIGENT EYE Operation

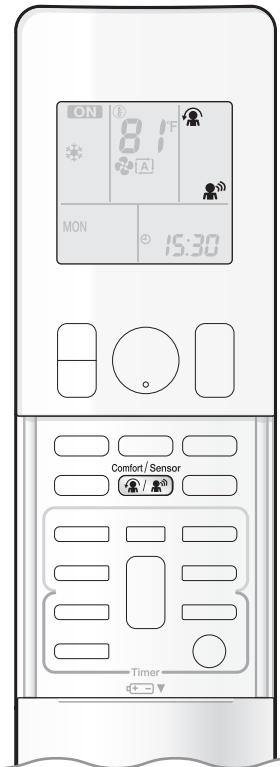

## ⚠ CAUTION

- Do not place large objects near the INTELLIGENT EYE sensor. Also keep heating units and humidifiers outside the sensor's detection area. This sensor can detect undesirable objects.
- Do not hit or violently push the INTELLIGENT EYE sensor. This can lead to damage and malfunction.



## To start operation

▶ Press  and select the desired mode.

- Each time  is pressed, a different setting option is displayed on the LCD.
- When INTELLIGENT EYE is selected, the INTELLIGENT EYE lamp lights green.



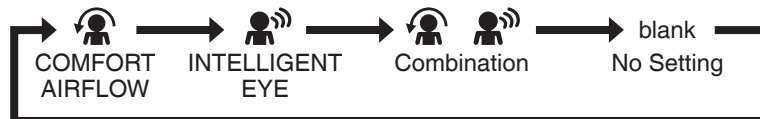

Display

- By selecting “ ” from the following icons, the air conditioner will switch to COMFORT AIRFLOW operation combined with INTELLIGENT EYE operation.



- When the flaps (horizontal blades) are swinging, selecting any of the modes above will cause the flaps (horizontal blades) to stop.
- The lamp lights when human movement is detected.

### COMFORT AIRFLOW / INTELLIGENT EYE operation settings

| Display   | Operation mode                      | Explanation  |
|---|-------------------------------------|--|
|  | COMFORT AIRFLOW                     | The flaps adjust the airflow direction upward while cooling, downward while heating. ▶Page 14  |
|  | INTELLIGENT EYE                     | The sensor detects the movement of people in the sensing areas and the louvers adjust the airflow direction to an area where people are not present. When there are no people in the sensing areas, the air conditioner switches to the energy saving mode. ▶Page 14 |
|  | COMFORT AIRFLOW and INTELLIGENT EYE | The air conditioner will be in COMFORT AIRFLOW operation combined with INTELLIGENT EYE operation. ▶Page 14   |
| Blank   | No function                         | -  |

## To cancel operation

▶ Press  until no icon is displayed.

- If the INTELLIGENT EYE operation was being used, the INTELLIGENT EYE lamp goes off.



## NOTE

### ■ Notes on COMFORT AIRFLOW operation

- The position of the flaps will change, preventing air from blowing directly on the occupants of the room.
- POWERFUL operation and COMFORT AIRFLOW operation cannot be used at the same time. Priority is given to the function of whichever button is pressed last.
- The airflow rate will be set to AUTO. If the up and down airflow direction is selected, COMFORT AIRFLOW operation will be canceled.

### ■ Notes on INTELLIGENT EYE operation

- Application range is as follows.

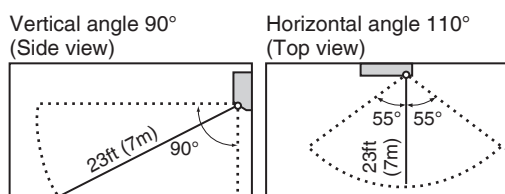

- While the air conditioner is in INTELLIGENT EYE operation, the louvers adjust the airflow direction if there are people in the sensing areas of the INTELLIGENT EYE so that the leftward or rightward airflow will not be directed to the people. If no people are detected in either area 1 or 2 for 20 minutes, the air conditioner switches to the energy saving mode with the set temperature shifted by 3.6°F (2°C). The air conditioner may switch to the energy saving operation even if there are people in the areas. This may occur depending on the clothes the people are wearing, if there is no movement of the people in the areas.
- The airflow direction from the louvers will be leftward if there are people in both areas 1 and 2. The air will also flow left if there is a person right in front of the sensor as the sensor judges that there are people in both areas.
- Due to the position of the sensor, people might be exposed to the airflow of the indoor unit if they are close to the front side of the indoor unit. If there are people close to the front side of the indoor unit or in both areas, it is recommended to use the COMFORT AIRFLOW and INTELLIGENT EYE operations simultaneously. Using both modes together, the air conditioner will not direct the airflow towards the people.
- The sensor may not detect moving objects further than 23ft (7m) away. (Please see the application range.)
- Sensor detection sensitivity changes according to the indoor unit location, the speed of passers-by, temperature range, etc.
- The sensor could also mistakenly detect pets, sunlight, fluttering curtains and light reflected off of mirrors as passers-by.
- INTELLIGENT EYE operation will not switch on during POWERFUL operation.
- NIGHT SET mode (▶ [Page 20](#)) will not switch on during use of INTELLIGENT EYE operation.

### ■ Notes on combining COMFORT AIRFLOW operation and INTELLIGENT EYE operation

- The airflow rate will be set to AUTO. If the up and down airflow direction is selected, COMFORT AIRFLOW operation will be canceled. Priority is given to the function of whichever button is pressed last.
- When the INTELLIGENT EYE sensor detects the movement of people, it adjusts the airflow direction upward (while in COOL operation) and downward (while in HEAT operation), by adjusting the flaps. When the sensor detects people, the louvers will direct the airflow in such a way that it will not be blown directly on them. If there are no people, the air conditioner will switch to energy saving operation after 20 minutes.



# POWERFUL Operation

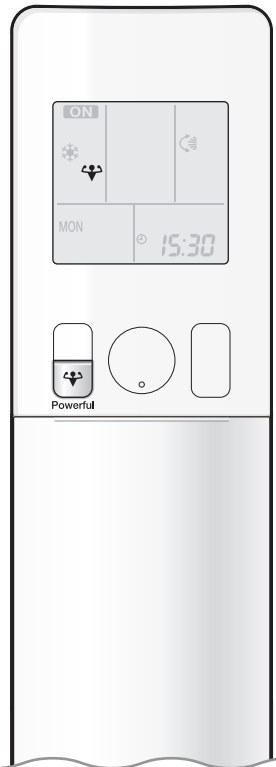

POWERFUL operation quickly maximizes the cooling (heating) effect in any operation mode. In this mode, the air conditioner operates at maximum capacity.

## To start POWERFUL operation

Press  during operation.

- “” is displayed on the LCD.
- POWERFUL operation ends in 20 minutes. Then the system automatically operates again with the previous settings which were used before POWERFUL operation.



## To cancel POWERFUL operation

Press  again.

- “” disappears from the LCD.

## NOTE

### Notes on POWERFUL operation

- Pressing  causes the settings to be canceled, and “” disappears from the LCD.
- POWERFUL operation will not increase the capacity of the air conditioner if the air conditioner is already in operation with its maximum capacity demonstrated.
  - In **COOL, HEAT and AUTO operation**  
To maximize the cooling (heating) effect, the capacity of outdoor unit increases and the airflow rate becomes fixed at the maximum setting. The temperature and airflow settings cannot be changed.
  - In **DRY operation**  
The temperature setting is lowered by 4.5°F (2.5°C) and the airflow rate is slightly increased.
  - In **FAN operation**  
The airflow rate is fixed at the maximum setting.
  - When using priority room setting  
Refer to “Note for Multi System”. ▶ **Page 27**

### Regarding the combination of POWERFUL and other operations

|                               |                |
|-------------------------------|----------------|
| POWERFUL + COMFORT AIRFLOW    | Not available* |
| POWERFUL + ECONO              |                |
| POWERFUL + OUTDOOR UNIT QUIET |                |

\*Priority is given to the function of whichever button is pressed last.



# ECONO / OUTDOOR UNIT QUIET Operation

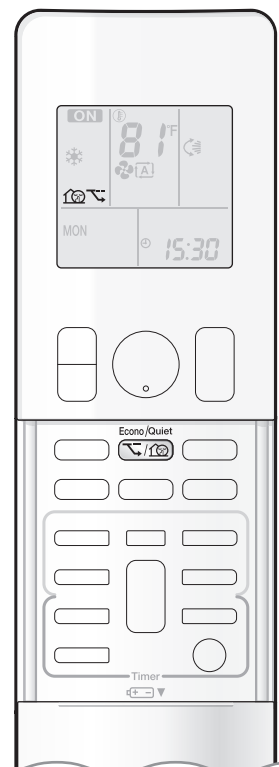

**ECONO operation** enables efficient operation by limiting the maximum power consumption.

This function is useful to prevent the circuit breaker from tripping when the unit operates alongside other appliances on the same circuit.

**OUTDOOR UNIT QUIET operation** lowers the noise level of the outdoor unit by changing the frequency and fan speed of the outdoor unit. This function is convenient during the night-time operation.

## To start operation

Press  and select the desired mode.

- Each time  is pressed, a different setting option is displayed on the LCD.

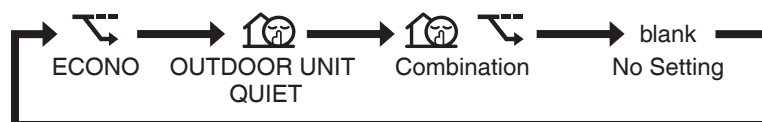



## To cancel operation

Press  until no icon is displayed.

## NOTE

### Notes on ECONO operation

- Pressing  causes the settings to be canceled, and “” disappears from the LCD.
- If the power consumption level is already low, switching to ECONO operation will not reduce the power consumption.

### Notes on OUTDOOR UNIT QUIET operation

- If using a multi system, the OUTDOOR UNIT QUIET operation will work only when this function is set on all operated indoor units. However, if using priority room setting, refer to “**Note for Multi System**”. ▶ [Page 27](#)
- Even if the operation is stopped by using the remote controller or the indoor unit ON/OFF switch when using OUTDOOR UNIT QUIET operation, “” will remain displayed on the remote controller.
- OUTDOOR UNIT QUIET operation will not reduce the frequency nor fan speed if they already are operating at reduced levels.
- This operation is performed with lower power and therefore may not provide a sufficient cooling (heating) effect.

### Possible combinations of ECONO / OUTDOOR UNIT QUIET operation and basic operations

|                    | Operation mode |     |      |      |     |
|--------------------|----------------|-----|------|------|-----|
|                    | AUTO           | DRY | COOL | HEAT | FAN |
| ECONO              | ✓              | ✓   | ✓    | ✓    | –   |
| OUTDOOR UNIT QUIET | ✓              | –   | ✓    | ✓    | –   |



# ON/OFF TIMER Operation

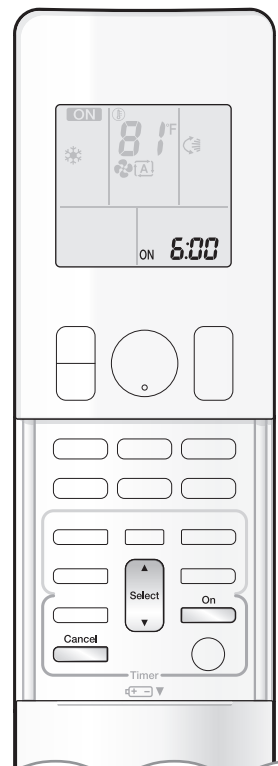

Timer functions are useful for automatically switching the air conditioner on or off at night or in the morning. You can also use the ON TIMER and OFF TIMER together.

## To use ON TIMER operation

- Check that the clock is correct.  
If not, set the clock to the present time. ▶ [Page 10](#)

**1. Press**  .



“6:00” is displayed on the LCD.  
“ON” blinks.

- “⌚” and day of the week disappear from the LCD.

**2. Press**  **until the time setting reaches the point you like.**

- Each pressing of either button increases or decreases the time setting by 10 minutes.  
Holding down either button changes the setting rapidly.

**3. Press**  **again.**

- The multi-monitor lamp blinks twice.
- “ON” and setting time are displayed on the LCD.
- The TIMER lamp periodically lights orange. ▶ [Page 5](#)



Display

## To cancel ON TIMER operation

**Press**  .

- “ON” and setting time disappear from the LCD.
- “⌚” and day of the week are displayed on the LCD.

## NOTE

### Notes on TIMER operation

- When TIMER is set, the present time is not displayed.
- When using the ON/OFF TIMER to start/stop operation, the actual operation start/stop time may differ from the time set. (Maximum of about 10 minutes)

### In the following cases, set the timer again.

- After the circuit breaker has turned off.
- After a power failure.
- After replacing the batteries in the remote controller.

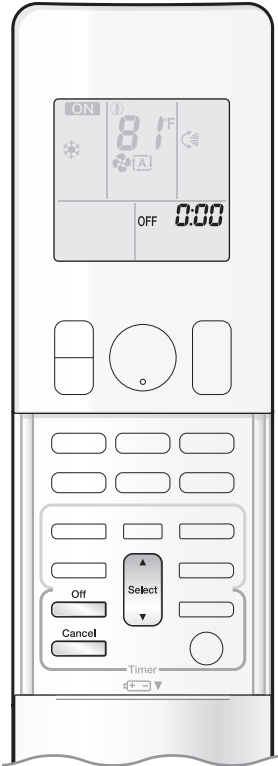

**To use OFF TIMER operation**

- Check that the clock is correct.  
If not, set the clock to the present time. ▶ **Page 10**

**1. Press** .



“0:00” is displayed on the LCD.  
“OFF” blinks.

- “☀” and day of the week disappear from the LCD.

**2. Press** **until the time setting reaches the point you like.**

- Each pressing of either button increases or decreases the time setting by 10 minutes.  
Holding down either button changes the time setting rapidly.

**3. Press** **again.**

- The multi-monitor lamp blinks twice.
- “OFF” and setting time are displayed on the LCD.
- The TIMER lamp periodically lights orange. ▶ **Page 5**



Display

**To cancel OFF TIMER operation**

**Press** .

- “OFF” and setting time disappear from the LCD.
- “☀” and day of the week are displayed on the LCD.

**To combine ON TIMER and OFF TIMER operation**

- A sample setting for combining the 2 timers is shown below.

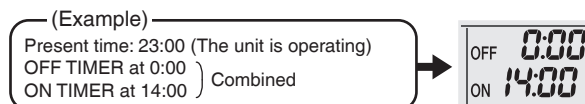

**NOTE**

**NIGHT SET mode**

- When the OFF TIMER is set, the air conditioner automatically adjusts the temperature setting (0.9°F (0.5°C) up in COOL, 3.6°F (2.0°C) down in HEAT) to prevent excessive cooling (heating) during sleeping hours.



# WEEKLY TIMER Operation

Up to 4 timer settings can be saved for each day of the week. This is convenient to adapt the WEEKLY TIMER to your family's life style.

## Setting example of the WEEKLY TIMER

The same timer settings are used from Monday through Friday, while different timer settings are used for the weekend.

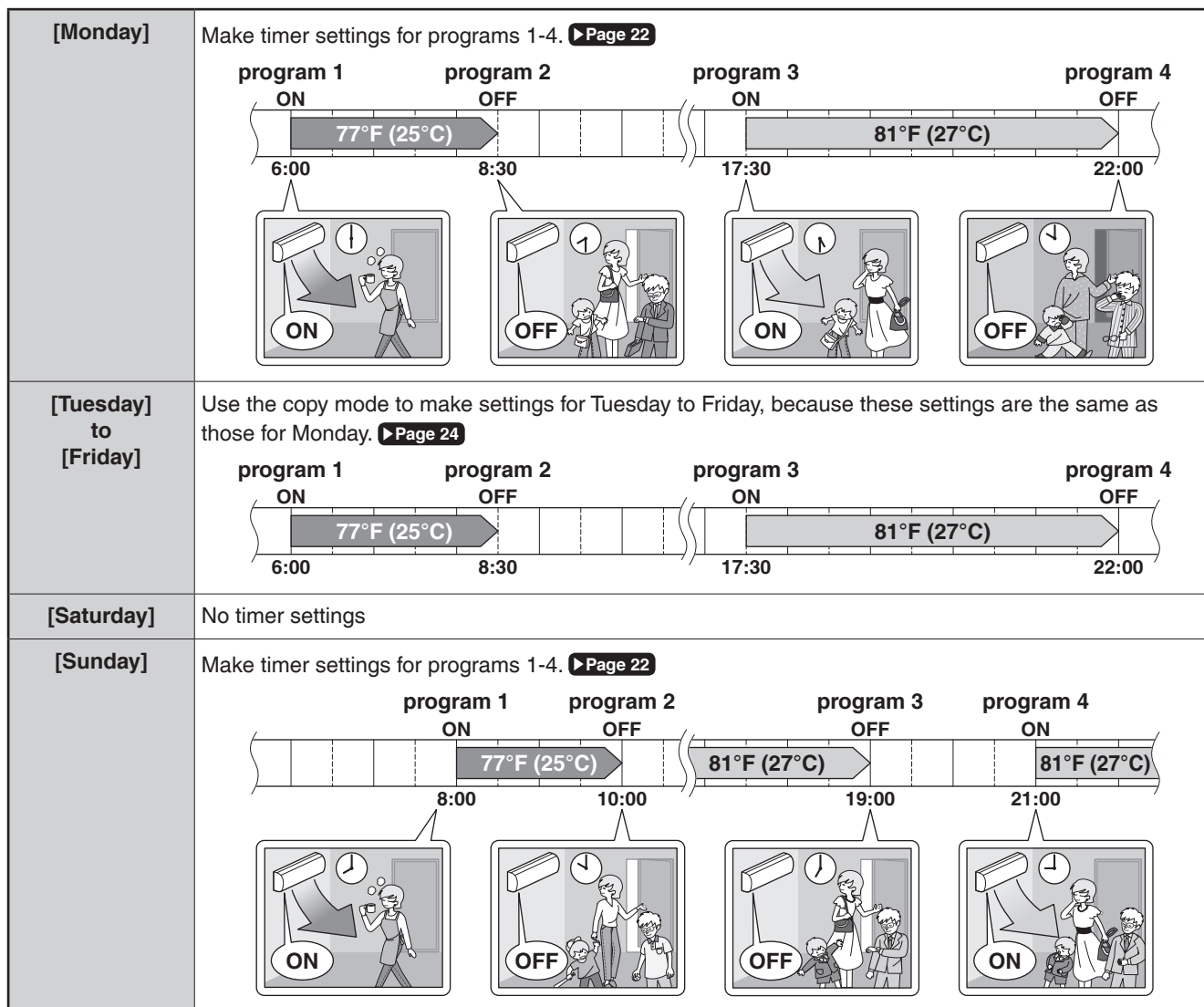

- Up to 4 reservations per day and 28 reservations per week can be set using the WEEKLY TIMER. The effective use of the copy mode simplifies timer programming.
- The use of ON-ON-ON-ON settings, for example, makes it possible to schedule operating mode and set temperature changes. Furthermore, by using OFF-OFF-OFF-OFF settings, only the turn off time of each day can be set. This will turn off the air conditioner automatically if you forget to turn it off.

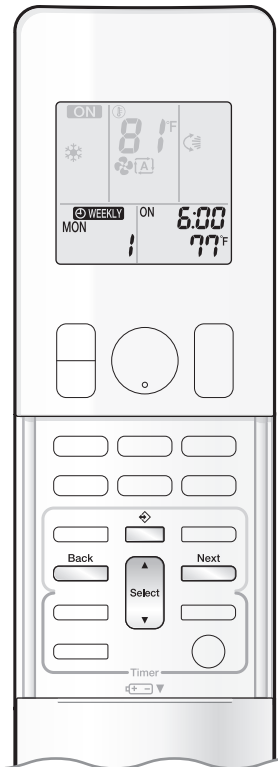

## To use WEEKLY TIMER operation

### Setting mode

- Make sure the day of the week and time are set.  
If not, set the day of the week and time. ▶ [Page 10](#)

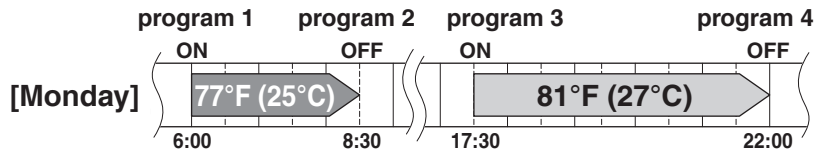

### Setting Displays

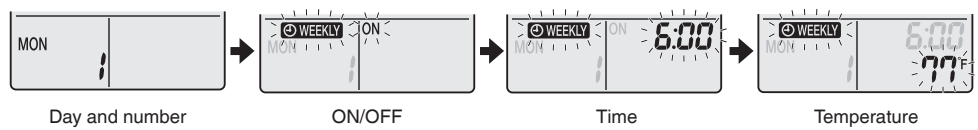

### 1. Press .

- The day of the week and the reservation number of the current day will be displayed.
- 1 to 4 settings can be made per day.

### 2. Press to select the desired day of the week and reservation number.

- Pressing changes the reservation number and the day of the week.

### 3. Press .

- The day of the week and reservation number will be set.
- “ ” and “ ON ” blink.

### 4. Press to select the desired mode.

- Pressing changes the “ ON ” or “ OFF ” setting in sequence.

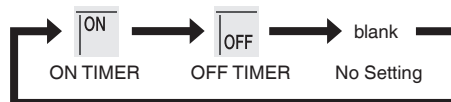

Pressing puts the sequence in reverse.

- In case the reservation has already been set, selecting “ blank ” deletes the reservation.
- Proceed to **STEP 9** if “ blank ” is selected.
- To return to the day of the week and reservation number setting, press .

### 5. Press .

- The ON/OFF TIMER mode will be set.
- “ ” and the time blink.



# WEEKLY TIMER Operation

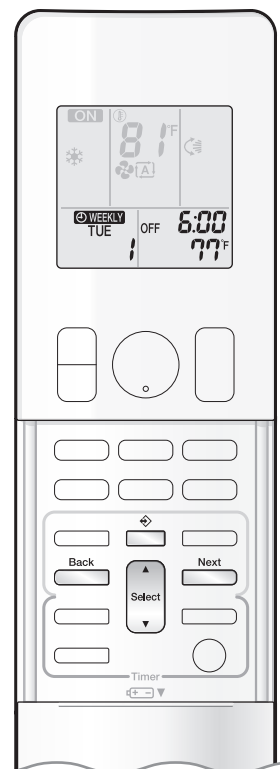

## 6. Press to select the desired time.

- The time can be set between 0:00 and 23:50 in 10-minute intervals.
- To return to the ON/OFF TIMER mode setting, press .
- Proceed to **STEP 9** when setting the OFF TIMER.

## 7. Press .

- The time will be set.
- “ ” and the temperature blink.

## 8. Press to select the desired temperature.

- The temperature can be set between 50°F (10°C) and 90°F (32°C).  
COOL or AUTO: The unit operates at 64°F (18°C) even if it is set at 50°F (10°C) to 63°F (17°C). **Page 11**  
HEAT or AUTO : The unit operates at 86°F (30°C) even if it is set at 87°F (31°C) to 90°F (32°C). **Page 11**
- To return to the time setting, press .
- The set temperature is only displayed when the mode setting is on.

## 9. Press .

- Be sure to direct the remote controller toward the indoor unit and check for a receiving tone and blinking of the multi-monitor lamp.
- The multi-monitor lamp blinks twice.
- Temperature and time are set in the case of ON TIMER operation, and the time is set in the case of OFF TIMER operation.
- The next reservation screen will appear.
- To continue further settings, repeat the procedure from **STEP 4**.

## 10. Press to complete the setting.

- “ ” is displayed on the LCD and WEEKLY TIMER operation is activated.
- The TIMER lamp periodically lights orange. **Page 5**  
The multi-monitor lamp will not light orange if all the reservation settings are deleted.



Display

- A reservation made once can be easily copied and the same settings used for another day of the week. Refer to **Copy mode** . **Page 24**

## NOTE

### Notes on WEEKLY TIMER operation

- Do not forget to set the clock on the remote controller first. **Page 10**
- The day of the week, ON/OFF TIMER mode, time and set temperature (only for ON TIMER mode) can be set with the WEEKLY TIMER. Other settings for the ON TIMER are based on the settings just before the operation.
- WEEKLY TIMER and ON/OFF TIMER operation cannot be used at the same time. The ON/OFF TIMER operation has priority if it is set while WEEKLY TIMER is still active. The WEEKLY TIMER will enter the standby state, and “ ” will disappear from the LCD. When the ON/OFF TIMER is up, the WEEKLY TIMER will automatically become active.
- Turning off the circuit breaker, power failure, and other similar events will render operation of the indoor unit's internal clock inaccurate. Reset the clock. **Page 10**
- can be used only for the time and temperature settings. It cannot be used to go back to the reservation number.



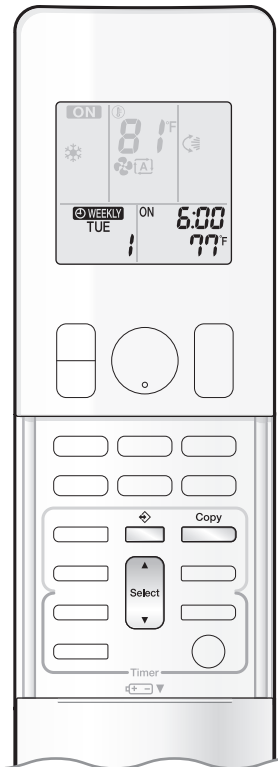

**Copy mode**

- A reservation made once can be copied to another day of the week. The whole reservation of the selected day of the week will be copied.

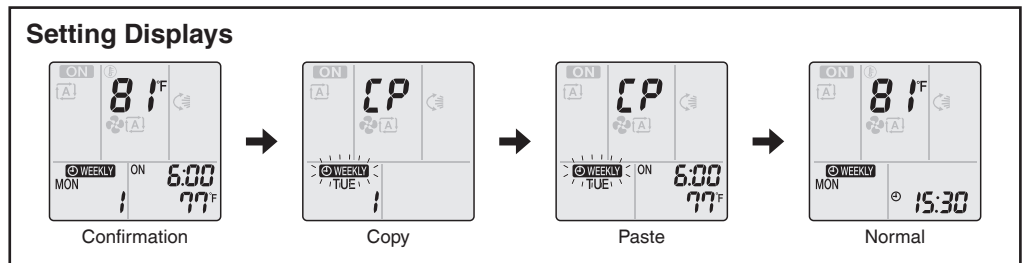
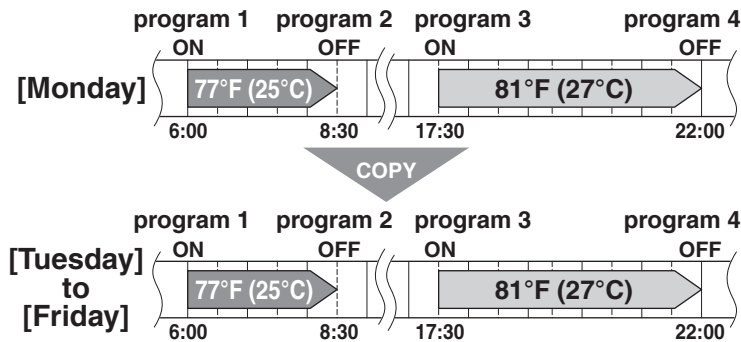

1. Press .
2. Press to confirm the day of the week to be copied.
3. Press .
  - The whole reservation of the selected day of the week will be copied.
4. Press to select the destination day of the week.
5. Press .
  - The multi-monitor lamp blinks twice.
  - The reservation will be copied to the selected day of the week. The whole reservation of the selected day of the week will be copied.
  - To continue copying the settings to other days of the week, repeat **STEP 4** and **STEP 5**.
6. Press to complete the setting.
  - “ WEEKLY” is displayed on the LCD and WEEKLY TIMER operation is activated.
  - The TIMER lamp periodically lights orange.

**NOTE**

**Note on COPY MODE**

- The entire reservation of the source day of the week is copied in the copy mode.
- In the case of making a reservation change for any day of the week individually after copying the content of weekly reservations, press and change the settings in the steps of **Setting mode** . **▶Page 22**



# WEEKLY TIMER Operation

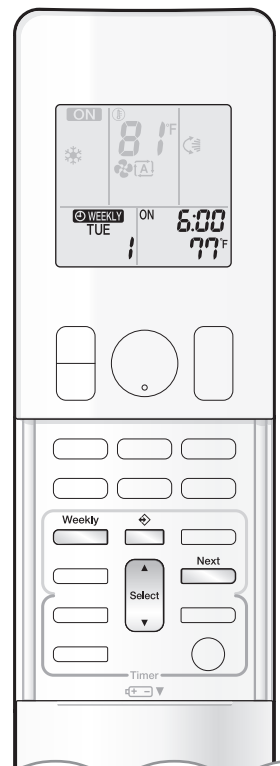

## Confirming a reservation

- The reservation can be confirmed.

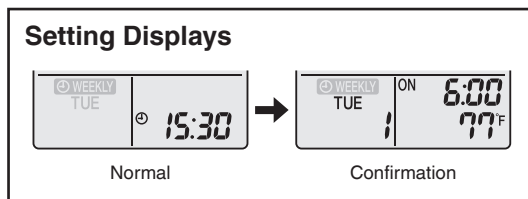

### 1. Press .

- The day of the week and the reservation number of the current day will be displayed.

### 2. Press to select the day of the week and the reservation number to be confirmed.

- Pressing displays the reservation details.
- To change the confirmed reserved settings, select the reservation number and press . The mode is switched to setting mode. Proceed to **Setting mode** STEP 4. [▶Page 22](#)

### 3. Press to exit the confirmation mode.

- “ ” is displayed on the LCD and WEEKLY TIMER operation is activated.
- The TIMER lamp periodically lights orange. [▶Page 5](#)  
The multi-monitor lamp will not light orange if all the reservation settings are deleted.



Display

## To deactivate WEEKLY TIMER operation

### ▶ Press while “ ” is displayed on the LCD.

- “ ” disappears from the LCD.
- To reactivate the WEEKLY TIMER operation, press again.
- If a reservation deactivated with is activated once again, the last reservation mode will be used.

## NOTE

- If not all the reservation settings are reflected, deactivate the WEEKLY TIMER operation once. Then press again to reactivate the WEEKLY TIMER operation.

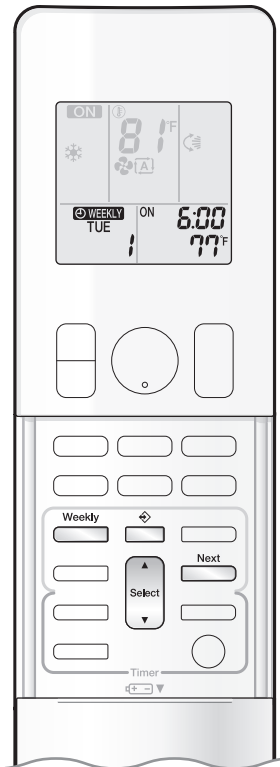

## To delete reservations

### An individual reservation

**1. Press** .

- The day of the week and the reservation number will be displayed.

**2. Press** to select the day of the week and the reservation number to be deleted.

**3. Press** .

- “ WEEKLY” and “ON” or “OFF” blink.

**4. Press** until no icon is displayed.

- Pressing changes the ON/OFF TIMER mode in sequence.
- Selecting “blank” will cancel any reservation you may have.

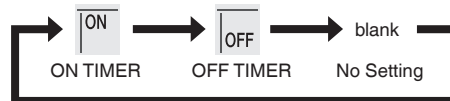

Pressing puts the sequence in reverse.

**5. Press** .

- The selected reservation will be deleted.

**6. Press** .

- If there are still other reservations, WEEKLY TIMER operation will be activated.

### Reservations for each day of the week

- This function can be used for deleting reservations for each day of the week.
- It can be used while confirming or setting reservations.

**1. Press** .

- The day of the week and the reservation number will be displayed.

**2. Press** to select the day of the week to be deleted.

**3. Hold** for about 5 seconds.

- The reservation of the selected day of the week will be deleted.

**4. Press** .

- If there are still other reservations, WEEKLY TIMER operation will be activated.

### All reservations

**Hold** for about 5 seconds with the normal display.

- Be sure to direct the remote controller toward the indoor unit and check for a receiving tone.
- This operation cannot be used for the WEEKLY TIMER setting display.
- All reservations will be deleted.

# Note for Multi System

A multi system has one outdoor unit connected to multiple indoor units.

## Selecting the operation mode

**When the priority room setting is active but the set unit is not operating or when the priority room setting is inactive**

When more than one indoor unit is operating, priority is given to the first unit that was turned on.

In this case, set the units that are turned on later to the same operation mode as the first unit.

Otherwise, they will enter the standby state, and the multi-monitor lamp will blink; this does not indicate malfunction.

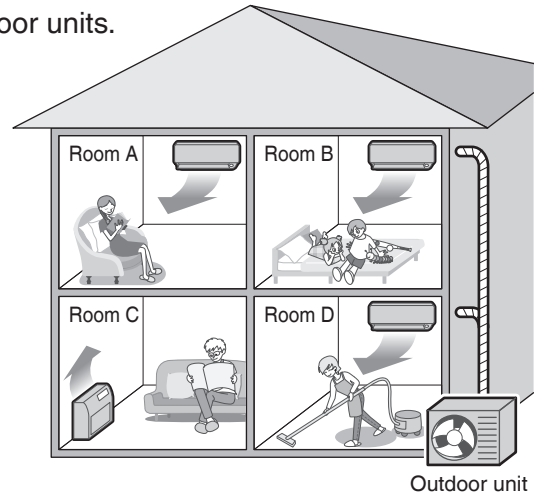

## NOTE

### Notes on operation mode for a multi system

- COOL, DRY and FAN operation may be used at the same time.
- AUTO operation automatically selects COOL operation or HEAT operation based on the indoor temperature. Therefore, AUTO operation is available when selecting the same operation mode as that of the room with the first unit to be turned on.

## CAUTION

- Normally, the operation mode in the room where the unit is first started is given priority, but the following situations are exceptions to this rule. If the operation mode of the first room is FAN operation, then using HEAT operation in any room after this will give priority to HEAT operation. In this situation, the indoor unit operating in FAN mode will switch to standby, and the multi-monitor lamp will blink.

### With the priority room setting active

Refer to "Priority room setting" on the next page.

## NIGHT QUIET mode (Available only for COOL operation)

NIGHT QUIET mode requires initial programming during installation. Please consult your retailer or dealer for assistance. NIGHT QUIET mode reduces the operation noise of the outdoor unit during the night-time hours to prevent annoyance to neighbors.

- NIGHT QUIET mode is activated when the temperature drops 10.8°F (6°C) or more below the highest temperature recorded that day. When the temperature difference between the current outdoor temperature and the maximum outdoor temperature becomes less than 7.2°F (4°C), this function will be canceled.
- NIGHT QUIET mode slightly reduces the cooling efficiency of the unit.

## OUTDOOR UNIT QUIET operation

Refer to "OUTDOOR UNIT QUIET Operation". ▶Page 18

**When the priority room setting is active but the set unit is not operating or when the priority room setting is inactive**

When using the OUTDOOR UNIT QUIET operation feature with a multi system, set all indoor units to OUTDOOR UNIT QUIET operation using their remote controllers.

When canceling OUTDOOR UNIT QUIET operation, simply cancel the mode on one of the operating indoor units using their remote controller.

However OUTDOOR UNIT QUIET operation will remain displayed on the remote controllers for the other rooms.

We recommend you cancel operation in all rooms using their remote controllers.

### With the priority room setting active

Refer to "Priority room setting" on the next page.

## COOL/HEAT mode lock

The COOL/HEAT mode lock requires initial programming during installation. Please consult your authorized dealer for assistance. The COOL/HEAT mode lock sets the unit forcibly to either COOL or HEAT operation. This function is convenient when you wish to set all indoor units connected to the multi system to the same operation mode.

### NOTE

- The COOL/HEAT mode lock cannot be activated together with the priority room setting.

## Priority room setting (Not available on some models)

The priority room setting requires initial programming during installation. Please consult your authorized dealer for assistance. The room designated as the priority room takes priority in the following situations.

### Operation mode priority

- As the operation mode of the priority room takes precedence, you can select a different operation mode from other rooms.

#### [Example]

- Room A is the priority room in this example.  
When COOL operation is selected in room A while operating the following modes in room B, C and D:

| Operation mode in room B, C and D | Status of room B, C and D when the unit in room A is in COOL operation  |
|-----------------------------------|---|
| COOL or DRY or FAN                | The current operation mode is maintained.   |
| HEAT                              | The unit enters the standby mode. Operation resumes when the room A unit stops operating.   |
| AUTO                              | If the unit is set to COOL operation, it continues. If the unit is set to HEAT operation, it enters the standby mode. Operation resumes when the room A unit stops operating. |

### Priority when POWERFUL operation is used

#### [Example]

- Room A is the priority room in this example.  
The indoor units in rooms A, B, C and D are all operating. If the unit in room A enters POWERFUL operation, operation capacity will be concentrated in room A. In such a case, the cooling (heating) efficiency of the units in room B, C and D may be slightly reduced.

### Priority when OUTDOOR UNIT QUIET operation is used

#### [Example]

- Room A is the priority room in this example.  
Just by setting the unit in room A to QUIET operation, the air conditioner starts OUTDOOR UNIT QUIET operation. You do not have to set all the indoor units in operation to OUTDOOR UNIT QUIET operation.

# Care and Cleaning

## ⚠ CAUTION

- Before cleaning, be sure to stop the operation and turn off the circuit breaker.
- Do not touch the aluminum fins of the indoor unit. If you touch those parts, this may cause an injury.

## ■ Quick reference

### How to open the upper front panel

- 1) Hold the upper front panel by the sides and open it.
- 2) Fix the panel with the panel support plate.

### How to close the upper front panel

- 1) Return the panel support plate to its previous position.
  - 2) Turn the unit on and then off to close the panel properly.
- See instructions in “**Reattach the filters and close the upper front panel.**” for a more detailed description.

▶ Page 30,31

## Cleaning parts

### Upper and lower front panels

- With the panels closed, wipe them with a soft damp cloth.

**If dirty**

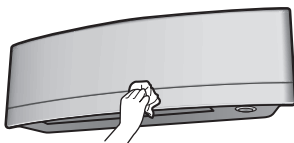

### Air filter

- Vacuum dust or wash the filter.

**Once every 2 weeks**

▶ Page 30

### Titanium apatite deodorizing filter

- Vacuum dust or replace the filter.

[Cleaning]

**Once every 6 months**

▶ Page 31

[Replacement]

**Once every 3 years**

▶ Page 31

### Indoor unit and remote controller

- Wipe them with a soft cloth.

**If dirty**

## Notes on cleaning

### For cleaning, do not use any of the following:

- Water hotter than 104°F (40°C)
- Volatile liquid such as benzine, gasoline and thinner
- Polishing compounds
- Rough materials such as a scrubbing brush

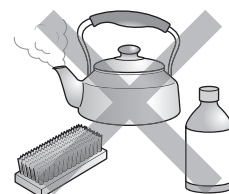

## ■ Air filter

### 1. Pull out the air filters.

- 1) Open the upper front panel.
- 2) Set the panel support plate between the ribs on the unit to fix the upper front panel.
- 3) Push the filter tab at the center of each air filter a little upwards, then pull it down.

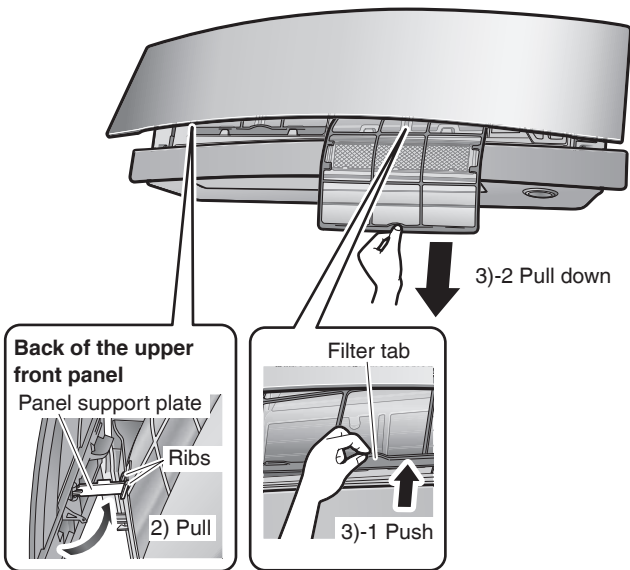

### 2. Wash the air filters with water or clean them with a vacuum cleaner.

- It is recommended to clean the air filters every 2 weeks.

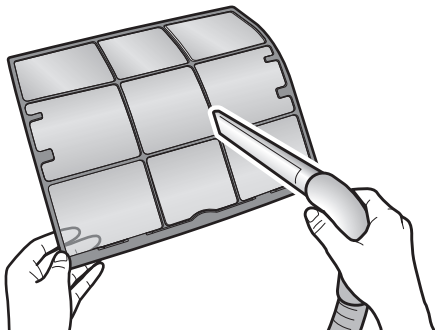

### If the dust does not come off easily

- Wash the air filters with neutral detergent thinned with lukewarm water, then let them dry in the shade.
- Be sure to remove the titanium apatite deodorizing filter. Refer to "Titanium apatite deodorizing filter" on the next page.

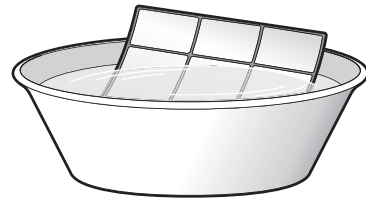

### 3. Reattach the filters and close the upper front panel.

- 1) Return the panel support plate to its previous position and close the upper front panel slowly.

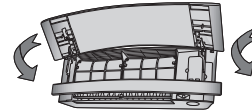

- 2) Do not push on the panel to close it.



- 3) Turn on the unit using the remote controller. Wait till the upper and lower front panels are completely open. Then, turn off the unit using the remote controller again.

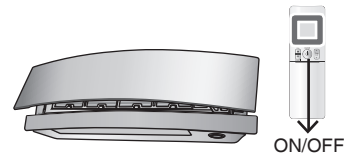

- 4) Once the both panels close completely, gently push the upper front panel to hook it into position.

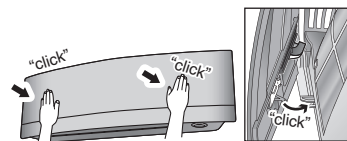

# Care and Cleaning

## ■ Titanium apatite deodorizing filter

### 1. Take off the titanium apatite deodorizing filters.

- 1) Open the upper front panel and pull out the air filters.
- 2) Hold the recessed parts of the frame and unhook the 4 claws.

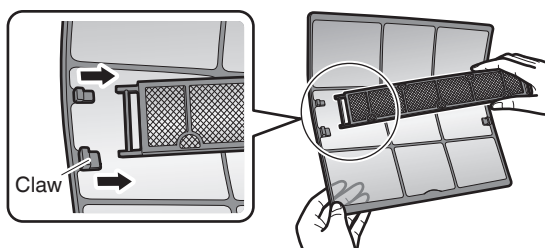

### 2. Clean or replace the titanium apatite deodorizing filters.

#### [Cleaning]

- 1) Vacuum dust, and soak in lukewarm water or water for about 10 to 15 minutes if very dirty.

- Do not remove the filter from the frame when washing with water.

- 2) After washing, shake off remaining water and let them dry in the shade.

- Do not wring out the filter to remove water from it.

#### [Replacement]

#### Remove the filter from the filter frame and attach a new one.

- Do not throw away the filter frame. Reuse the filter frame when replacing the titanium apatite deodorizing filter.
- When attaching the filter, check that the filter is properly set in the tabs.

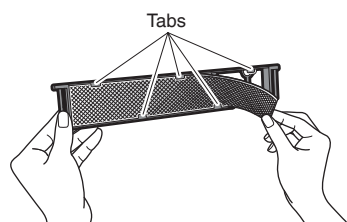

- Dispose of the old filter as non-flammable waste.

### 3. Reattach the filters and close the upper front panel.

- 1) Return the panel support plate to its previous position and close the upper front panel slowly.

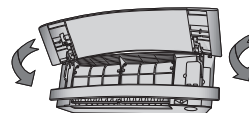

- 2) Do not push on the panel to close it.



- 3) Turn on the unit using the remote controller. Wait till the upper and lower front panels are completely open. Then, turn off the unit using the remote controller again.

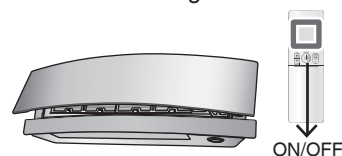

- 4) Once the both panels close completely, gently push the upper front panel to hook it into position.

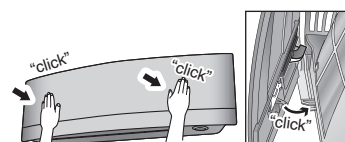

## NOTE





- Operation with dirty filters:
  - cannot deodorize the air,
  - cannot clean the air,
  - results in poor heating or cooling,
  - may cause odor.
- Dispose of old filters as non-flammable waste.
- To order a titanium apatite deodorizing filter, contact the dealer where you bought the air conditioner.

|          |  |
|----------|--|
| Item     | Titanium apatite deodorizing filter (set of 2) |
| Part No. | KAF970A46 (without frame)                      |



## ■ Prior to a long period of non-use

### 1. Operate the FAN mode for several hours to dry out the inside.

- 1) Press  and select “”.
  - When a multi outdoor unit is connected, make sure the HEAT operation is not being used in other rooms before you use the FAN operation. 
- 2) Press  and start the operation.

### 2. After operation stops, turn off the circuit breaker for the room air conditioner.

### 3. Clean the air filters and reattach them.

### 4. To prevent battery leakage, take out the batteries from the remote controller.

## ■ We recommend periodical maintenance

- In certain operating conditions, the inside of the air conditioner may get foul after several seasons of use, resulting in poor performance. It is recommended to have periodical maintenance by a qualified contractor in addition to regular cleaning by the user.
- For qualified contractor maintenance, please contact the dealer where you bought the air conditioner.

# FAQ

## Indoor unit

### The flaps do not start swinging immediately.

- The air conditioner is adjusting the position of the flaps. The flaps will start moving soon.

### The air conditioner stops generating airflow during HEAT operation.

- Once the set temperature is reached, the airflow rate is reduced and operation stopped in order to avoid generating a cool airflow. Operation will resume automatically when the indoor temperature falls.

### HEAT operation stops suddenly and a flowing sound is heard.

- The outdoor unit is defrosting. HEAT operation starts after the frost on the outdoor unit has been removed. This can take about 4 to 12 minutes.

### Operation does not start soon.

- **When the unit is turned on again soon after being turned off.**
- **When the mode was reselected.**
  - This is to protect the air conditioner. You should wait for about 3 minutes.

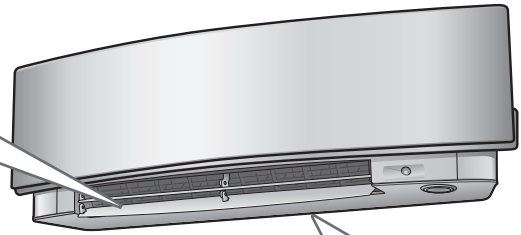

### Different sounds are heard.

- **A sound like flowing water**
  - This sound is generated because the refrigerant in the air conditioner is flowing.
  - This is a pumping sound of the water in the air conditioner and can be heard when the water is pumped out from the air conditioner during COOL or DRY operation.
  - The refrigerant flows in the air conditioner even if the air conditioner is not working when the indoor units in other rooms are in operation.
- **Blowing sound**
  - This sound is generated when the flow of the refrigerant in the air conditioner is switched over.
- **Ticking sound**
  - This sound is generated when the cabinet and frame of the air conditioner slightly expand or shrink as a result of temperature changes.
- **Whistling sound**
  - This sound is generated when refrigerant flows during defrosting operation.
- **Clicking sound during operation or idle time**
  - This sound is generated when the refrigerant control valves or the electrical parts operate.
- **Clopping sound**
  - This sound is heard from the inside of the air conditioner when the exhaust fan is activated while the room doors are closed. Open the window or turn off the exhaust fan.

## Outdoor unit

### Operating sound is loud.

- When frost forms on the heat exchanger of the outdoor unit, the operating sound level increases slightly.

### The outdoor unit emits water or steam.

- **In HEAT operation**
  - The frost on the outdoor unit melts into water or steam when the air conditioner is in defrosting operation.
- **In COOL or DRY operation**
  - Moisture in the air condenses into water on the cool surface of the outdoor unit piping and drips.

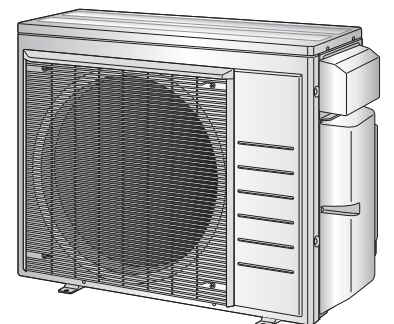

# Troubleshooting

Before making an inquiry or a request for repair, please check the following.  
If the problem persists, consult your dealer.



## Not a problem

This case is not a problem.



## Check

Please check again before requesting repairs.

### The air conditioner does not operate

| Case                            | Description / what to check   |
|---------------------------------|---|
| Multi-monitor lamp is off.      | <ul style="list-style-type: none"> <li> • Has the circuit breaker been tripped or the fuse blown?</li> <li>• Is there a power failure?</li> <li>• Are batteries set in the remote controller?</li> <li>• Is the timer setting correct?</li> </ul>   |
| Multi-monitor lamp is blinking. | <ul style="list-style-type: none"> <li> • Turn off the power with the circuit breaker and restart operation with the remote controller. If the multi-monitor lamp is still blinking, check the error code and consult your dealer.</li> </ul> <p style="text-align: right;"><a href="#">▶ Page 38</a></p> |

### The air conditioner suddenly stops operating

| Case                            | Description / what to check  |
|---------------------------------|--|
| Multi-monitor lamp is on.       | <ul style="list-style-type: none"> <li> • To protect the system, the air conditioner may stop operating after sudden large voltage fluctuations. It automatically resumes operation in about 3 minutes.</li> </ul>   |
| Multi-monitor lamp is blinking. | <ul style="list-style-type: none"> <li> • Are the air filters dirty?<br/>Clean the air filters.</li> <li>• Is there anything blocking the air inlet or air outlet of the indoor unit or outdoor unit?<br/>Stop operation and after turning off the circuit breaker, remove the obstruction. Then restart operation with the remote controller. If the multi-monitor lamp is still blinking, check the error code and consult your dealer. <a href="#">▶ Page 38</a></li> <li>• Are operation modes all the same for indoor units connected to outdoor units in the multi system?<br/>If not, set all indoor units to the same operation mode and confirm that the lamps. Moreover, when the operation mode is in AUTO, set all indoor unit operation modes to COOL or HEAT for a moment and check again that the lamps are normal. If the lamps stop blinking after the above steps, there is no malfunction. <a href="#">▶ Page 27</a></li> </ul> |

### The air conditioner does not stop operating



| Case   | Description / what to check  |
|--|--|
| The air conditioner continues operating even after operation is stopped. | <ul style="list-style-type: none"> <li> <ul style="list-style-type: none"> <li>■ <b>Immediately after the air conditioner is stopped</b> <ul style="list-style-type: none"> <li>• The outdoor unit fan continues rotating for about another 1 minute to protect the system.</li> </ul> </li> <li>■ <b>While the air conditioner is not in operation</b> <ul style="list-style-type: none"> <li>• When the outdoor temperature is high, the outdoor unit fan may start rotating to protect the system.</li> </ul> </li> </ul> </li> </ul> |

### The room does not cool down / warm up

| Case                   | Description / what to check  |
|------------------------|--|
| Air does not come out. | <ul style="list-style-type: none"> <li> <ul style="list-style-type: none"> <li>■ <b>In HEAT operation</b> <ul style="list-style-type: none"> <li>• The air conditioner is warming up. Wait for about 1 to 4 minutes.</li> <li>• During defrosting operation, hot air does not flow out of the indoor unit.</li> </ul> </li> <li>■ <b>When the air conditioner operates immediately after the circuit breaker is turned on</b> <ul style="list-style-type: none"> <li>• The air conditioner is preparing to operate. Wait for about 3 to 20 minutes.</li> </ul> </li> </ul> </li> </ul> |

# Troubleshooting



## The room does not cool down / warm up

| Case                                      | Description / what to check   |
|---|---|
| Air does not come out /<br>Air comes out. | <p> ■ <b>Is the airflow rate setting appropriate?</b></p> <ul style="list-style-type: none"> <li>Is the airflow rate setting low, such as “Indoor unit quiet” or “Airflow rate 1”? Increase the airflow rate setting.</li> </ul> <p>■ <b>Is the set temperature appropriate?</b></p> <p>■ <b>Is the adjustment of the airflow direction appropriate?</b></p>   |
| Air comes out.                            | <p> • Is there any furniture directly under or beside the indoor unit?</p> <p>• Is the air conditioner in ECONO operation or OUTDOOR UNIT QUIET operation? <a href="#">▶Page 18</a></p> <p>• Is the air filter dirty?</p> <p>• Is there anything blocking the air inlet or air outlet of the indoor unit or outdoor unit?</p> <p>• Is a window or door open?</p> <p>• Is an exhaust fan turning?</p> |

## Mist comes out

| Case                               | Description / what to check  |
|------------------------------------|--|
| Mist comes out of the indoor unit. | <p> • This happens when the air in the room is cooled into mist by the cold airflow during COOL or other operation.</p> |



## Remote controller

| Case   | Description / what to check  |
|--|--|
| The unit does not receive signals from the remote controller or has a limited operating range. | <p> • The batteries may be exhausted. Replace both batteries with new dry batteries AAA.LR03 (alkaline). For details, refer to “<b>Preparation Before Operation</b>”. <a href="#">▶Page 9</a></p> <p>• Signal communication may be disabled if an electronic-starter-type fluorescent lamp (such as inverter-type lamps) is in the room. Consult your dealer if that is the case.</p> <p>• The remote controller may not function correctly if the transmitter is exposed to direct sunlight.</p> |
| LCD is faint, is not working, or the display is erratic.                                       | <p> • The batteries may be exhausted. Replace both batteries with new dry batteries AAA.LR03 (alkaline). For details, refer to “<b>Preparation Before Operation</b>”. <a href="#">▶Page 9</a></p>   |
| Other electric devices start operating.  | <p> • If the remote controller activates other electric devices, move them away or consult your dealer.</p>   |





## Air has an odor

| Case                                   | Description / what to check   |
|--|---|
| The air conditioner gives off an odor. | <p> • The room odor absorbed in the unit is discharged with the airflow. We recommend you to have the indoor unit cleaned. Please consult your dealer.</p> |

## Upper and lower front panels

| Case   | Description / what to check  |
|--|--|
| Upper and lower front panels do not open. (Multi-monitor lamp is blinking.)  | <p> • Is there something caught in the upper and lower front panels? Remove the object and attempt operation again using the remote controller. If the upper and lower front panels still do not open and the multi-monitor lamp is still blinking, consult your dealer where you bought the air conditioner.</p> |
| Upper front panel does not close completely.   | <p> • Are the upper front panel locks set appropriately?</p>  |
| If the upper and lower front panels are closed while the air conditioner is in operation, the air conditioner will stop operating and the multi-monitor lamp will blink. | <p> • Restart the air conditioner after stopping the operation of the air conditioner with the remote controller.</p>   |

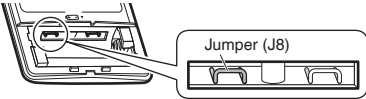
## Others

| Case  | Description / what to check  |
|---|--|
| The air conditioner suddenly starts behaving strangely during operation.    | <p> • The air conditioner may malfunction due to lightning or radio. If the air conditioner malfunctions, turn off the power with the circuit breaker and restart the operation with the remote controller.</p> |
| HEAT operation cannot be selected, even though the unit is heat pump model. | <p> • Check that the jumper (J8) has not been cut. If it has been cut, contact your dealer.</p>                              |
| The ON/OFF TIMER does not operate according to the settings.                | <p> • Check if the ON/OFF TIMER and the WEEKLY TIMER are set to the same time. Change or deactivate the settings in the WEEKLY TIMER. <a href="#">▶Page 21</a></p>  |

## Notes on the operating conditions

- If operation continues under any conditions other than those listed in the table,
  - A safety device may activate to stop the operation. (With a multi connection in COOL operation, the safety device may work to stop the operation of the outdoor unit only.)
  - Dew may form on the indoor unit and drip from it when COOL or DRY operation is selected.

| Mode       | Operating conditions   |
|------------|--|
| COOL / DRY | Outdoor temperature: [MXS models]: 14-115°F (–10-46°C)<br>[MXL models]: 14-115°F (–10-46°C)<br>[RX models]: 50-115°F (10-46°C)                                       |
|            | Indoor temperature: 64-90°F (18-32°C)<br>Indoor humidity: 80% max.   |
| HEAT       | Outdoor temperature: [MXS models]: 5-75°F (–15-24°C)<br>[MXL models]: –13-75°F (–25-24°C)<br>[RX models]: 5-75°F (–15-24°C)<br>Indoor temperature: 50-86°F (10-30°C) |

# Troubleshooting

## ■ Call your dealer immediately

### WARNING

**When an abnormality (such as a burning smell) occurs, stop operation and turn off the circuit breaker.**

- Continued operation in an abnormal condition may result in problems, electric shock or fire.
- Consult the dealer where you bought the air conditioner.

**Do not attempt to repair or modify the air conditioner by yourself.**

- Incorrect work may result in electric shock or fire.
- Consult the dealer where you bought the air conditioner.

**If one of the following symptoms takes place, call your dealer immediately.**

- The power cord is abnormally hot or damaged.
- An abnormal sound is heard during operation.
- The circuit breaker cuts off the operation frequently.
- A switch or a button often fails to work properly.
- There is a burning smell.
- Water leaks from the indoor unit.

Turn off the circuit breaker and call your dealer.



### ■ After a power failure

- The air conditioner automatically resumes operation in about 3 minutes. Please wait for a while.

### ■ Lightning

- If there is a risk lightning could strike in the neighborhood, stop operation and turn off the circuit breaker to protect the system.

## ■ Disposal requirements

- Dismantling of the unit, handling of the refrigerant, oil and other parts, should be done in accordance with the relevant local and national regulations.



## ■ Fault diagnosis by remote controller

- The remote controller can receive relevant error codes from the indoor unit.

**1.** When  is held down for about 5 seconds, “00” blinks in the temperature display section.

**2.** Press  repeatedly until a long beep is produced.

- The code indication changes as shown below, and notifies you with a long beep.

|              | CODE                                 | MEANING   |
|--------------|--------------------------------------|---|
| SYSTEM       | 00                                   | NORMAL  |
|              | U0                                   | REFRIGERANT SHORTAGE  |
|              | U2                                   | OVER-VOLTAGE DETECTION                                      |
|              | U4                                   | SIGNAL TRANSMISSION ERROR (BETWEEN INDOOR AND OUTDOOR UNIT) |
| INDOOR UNIT  | A1                                   | INDOOR UNIT PCB ABNORMALITY                                 |
|              | A5                                   | FREEZE-UP PROTECTION OR HEATING PEAK-CUT CONTROL            |
|              | A6                                   | FAN MOTOR (DC MOTOR) ABNORMALITY                            |
|              | C4                                   | INDOOR HEAT EXCHANGER THERMISTOR ABNORMALITY                |
|              | C7                                   | FRONT PANEL OPEN /CLOSE FAULT                               |
| OUTDOOR UNIT | C9                                   | ROOM TEMPERATURE THERMISTOR ABNORMALITY                     |
|              | EA                                   | FOUR WAY VALVE ABNORMALITY                                  |
|              | E1                                   | OUTDOOR UNIT PCB ABNORMALITY                                |
|              | E5                                   | OL ACTIVATION (COMPRESSOR OVERLOAD)                         |
|              | E6                                   | COMPRESSOR LOCK   |
|              | E7                                   | DC FAN LOCK   |
|              | F3                                   | DISCHARGE PIPE TEMPERATURE CONTROL                          |
|              | H0                                   | COMPRESSOR SYSTEM SENSOR ABNORMALITY                        |
|              | H6                                   | POSITION SENSOR ABNORMALITY                                 |
|              | H8                                   | DC VOLTAGE / CURRENT SENSOR ABNORMALITY                     |
|              | H9                                   | OUTDOOR TEMPERATURE THERMISTOR ABNORMALITY                  |
|              | J3                                   | DISCHARGE PIPE THERMISTOR ABNORMALITY                       |
|              | J6                                   | OUTDOOR HEAT EXCHANGER THERMISTOR ABNORMALITY               |
| L4           | RADIATION FIN TEMPERATURE RISE       |   |
| L5           | OUTPUT OVERCURRENT DETECTION         |   |
| P4           | RADIATION FIN THERMISTOR ABNORMALITY |   |

## NOTE

- A short beep and 2 consecutive beeps indicate non-corresponding codes.
- To cancel the code display, hold  down for about 5 seconds. The code display also clears if no button is pressed for 1 minute.

# Quick Reference

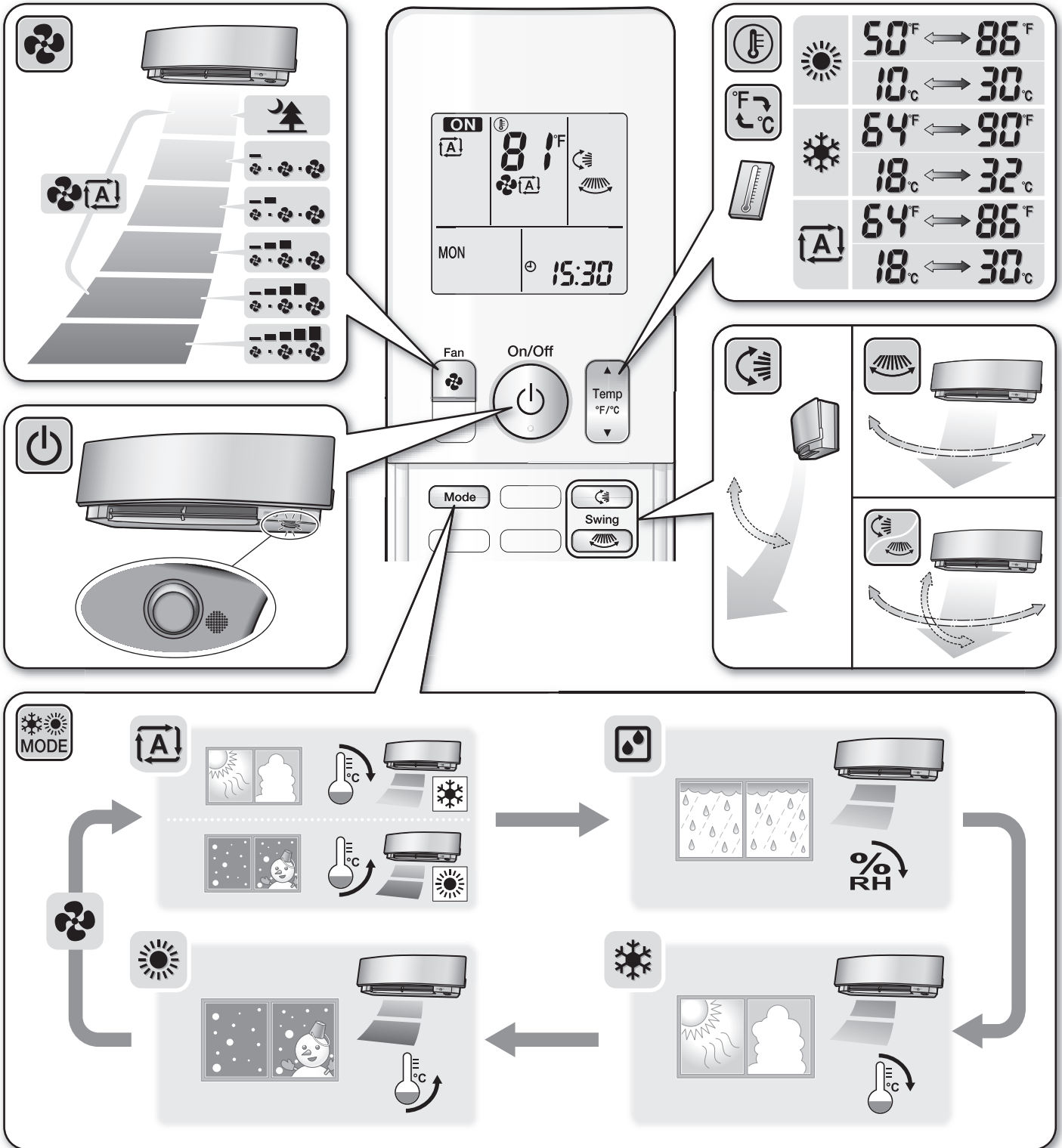

**DAIKIN NORTH AMERICA LLC**

19001 Kermier Road  
Houston, TX 77484  
<http://www.northamerica-daikin.com/>



The two-dimensional bar code is a manufacturing code.

3P436086-1C M15B216C (1811)HT