

**DAIKIN**



DAIKIN ROOM AIR CONDITIONER

# INSTALLATION MANUAL

R410A Split Series



Installation manual  
Manuel d'installation  
Manual de instalación

English

Français

Español

## MODELS

---

FTX09NMVJU	FTK09NMVJU
FTX12NMVJU	FTK12NMVJU
FTX15NMVJU	FTK18NMVJU
FTX18NMVJU	FTK24NMVJU
FTX24NMVJU	FTKN09NMVJU
FTXN09NMVJU	FTKN12NMVJU
FTXN12NMVJU	FTKN18NMVJU
FTXN18NMVJU	FTKN24NMVJU
FTXN24NMVJU	

# Contents

<b>Safety Considerations</b> .....	<b>1</b>	<b>Refrigerant Piping Work</b> .....	<b>9</b>
<b>Accessories</b> .....	<b>3</b>	1. Flaring the pipe end.....	9
<b>Choosing an Installation Site</b> .....	<b>3</b>	2. Refrigerant piping .....	9
1. Indoor unit .....	3	<b>Installation Tips</b> .....	<b>10</b>
2. Wireless remote controller.....	3	1. Removing and installing the front panel .....	10
<b>Indoor Unit Installation Diagram</b> .....	<b>4</b>	2. Removing and installing the front grille.....	11
<b>Indoor Unit Installation</b> .....	<b>5</b>	3. How to set the different addresses .....	11
1. Installing the mounting plate.....	5	<b>Trial Operation and Testing</b> .....	<b>12</b>
2. Drilling a wall hole and installing wall embedded pipe.....	6	1. Trial operation and testing .....	12
3. Installing the indoor unit .....	6	2. Test items .....	12
4. Wiring .....	8		
5. Drain piping .....	8		

## Safety Considerations





Read these **Safety Considerations for Installation** carefully before installing an air conditioner or heat pump. After completing the installation, make sure that the unit operates properly during the startup operation.

Instruct the user on how to operate and maintain the unit.

Inform users that they should store this installation manual with the operation manual for future reference.

Always use a licensed installer or contractor to install this product. Improper installation can result in water or refrigerant leakage, electric shock, fire, or explosion.

Meanings of **DANGER**, **WARNING**, **CAUTION**, and **NOTE** Symbols:

-  **DANGER** ..... Indicates an imminently hazardous situation which, if not avoided, will result in death or serious injury.
-  **WARNING** ..... Indicates a potentially hazardous situation which, if not avoided, could result in death or serious injury.
-  **CAUTION** ..... Indicates a potentially hazardous situation which, if not avoided, may result in minor or moderate injury. It may also be used to alert against unsafe practices.
-  **NOTE** ..... Indicates situations that may result in equipment or property-damage accidents only.

### **DANGER** \_\_\_\_\_

- Refrigerant gas is heavier than air and replaces oxygen. A massive leak can lead to oxygen depletion, especially in basements, and an asphyxiation hazard could occur leading to serious injury or death.
- Do not ground units to water pipes, gas pipes, telephone wires, or lightning rods as incomplete grounding can cause a severe shock hazard resulting in severe injury or death. Additionally, grounding to gas pipes could cause a gas leak and potential explosion causing severe injury or death.

- If refrigerant gas leaks during installation, ventilate the area immediately. Refrigerant gas may produce toxic gas if it comes into contact with fire. Exposure to this gas could cause severe injury or death.
- After completing the installation work, check that the refrigerant gas does not leak throughout the system.
- Do not install unit in an area where flammable materials are present due to risk of explosions that can cause serious injury or death.
- Safely dispose all packing and transportation materials in accordance with federal/state/local laws or ordinances. Packing materials such as nails and other metal or wood parts, including plastic packing materials used for transportation may cause injuries or death by suffocation.

### **WARNING** \_\_\_\_\_

- Only qualified personnel must carry out the installation work. Installation must be done in accordance with this installation manual. Improper installation may result in water leakage, electric shock, or fire.
- When installing the unit in a small room, take measures to keep the refrigerant concentration from exceeding allowable safety limits. Excessive refrigerant leaks, in the event of an accident in a closed ambient space, can lead to oxygen deficiency.
- Use only specified accessories and parts for installation work. Failure to use specified parts may result in water leakage, electric shock, fire, or the unit falling.
- Install the air conditioner or heat pump on a foundation strong enough that it can withstand the weight of the unit. A foundation of insufficient strength may result in the unit falling and causing injuries.
- Take into account strong winds, typhoons, or earthquakes when installing. Improper installation may result in the unit falling and causing accidents.

- Make sure that a separate power supply circuit is provided for this unit and that all electrical work is carried out by qualified personnel according to local, state, and national regulations. An insufficient power supply capacity or improper electrical construction may lead to electric shock or fire.
- Make sure that all wiring is secured, that specified wires are used, and that no external forces act on the terminal connections or wires. Improper connections or installation may result in fire.
- When wiring, position the wires so that the electrical wiring box cover can be securely fastened. Improper positioning of the electrical wiring box cover may result in electric shock, fire, or the terminals overheating.
- Before touching electrical parts, turn off the unit.
- It is recommended to install a ground fault circuit interrupter if one is not already available. This helps prevent electric shock or fire.
- Securely fasten the outdoor unit terminal cover (panel). If the terminal cover/panel is not installed properly, dust or water may enter the outdoor unit causing fire or electric shock.
- When installing or relocating the system, keep the refrigerant circuit free from substances other than the specified refrigerant (R410A) such as air. Any presence of air or other foreign substance in the refrigerant circuit can cause an abnormal pressure rise or rupture, resulting in injury.
- Do not change the setting of the protection devices. If the pressure switch, thermal switch, or other protection device is shorted and operated forcibly, or parts other than those specified by Daikin are used, fire or explosion may occur.

### CAUTION

- Do not touch the switch with wet fingers. Touching a switch with wet fingers can cause electric shock.
- Do not allow children to play on or around the unit to prevent injury.
- The heat exchanger fins are sharp enough to cut. To avoid injury wear gloves or cover the fins while working around them.
- Do not touch the refrigerant pipes during and immediately after operation as the refrigerant pipes may be hot or cold, depending on the condition of the refrigerant flowing through the refrigerant piping, compressor, and other refrigerant cycle parts. Your hands may suffer burns or frostbite if you touch the refrigerant pipes. To avoid injury, give the pipes time to return to normal temperature or, if you must touch them, be sure to wear proper gloves.
- Install drain piping to proper drainage. Improper drain piping may result in water leakage and property damage.
- Insulate piping to prevent condensation.
- Be careful when transporting the product.
- Do not turn off the power immediately after stopping operation. Always wait for at least 5 minutes before turning off the power. Otherwise, water leakage may occur.
- Do not use a charging cylinder. Using a charging cylinder may cause the refrigerant to deteriorate.
- Refrigerant R410A in the system must be kept clean, dry, and tight.
  - (a) Clean and Dry -- Foreign materials (including mineral oils such as SUNISO oil or moisture) should be prevented from getting into the system.

(b) Tight -- R410A does not contain any chlorine, does not destroy the ozone layer, and does not reduce the earth's protection against harmful ultraviolet radiation. R410A can contribute to the greenhouse effect if it is released. Therefore take proper measures to check for the tightness of the refrigerant piping installation. Read the chapter *Refrigerant Piping Work* and follow the procedures.

- Since R410A is a blend, the required additional refrigerant must be charged in its liquid state. If the refrigerant is charged in a state of gas, its composition can change and the system will not work properly.
- The indoor unit is for R410A. See the catalog for indoor models that can be connected. Normal operation is not possible when connected to other units.
- Remote controller (wireless kit) transmitting distance can be shorter than expected in rooms with electronic fluorescent lamps (inverter or rapid start types). Install the indoor unit far away from fluorescent lamps as much as possible.
- Indoor units are for indoor installation only. Outdoor units can be installed either outdoors or indoors. This unit is for indoor use.
- Do not install the air conditioner or heat pump in the following locations:
  - (a) Where a mineral oil mist or oil spray or vapor is produced, for example, in a kitchen. Plastic parts may deteriorate and fall off or result in water leakage.
  - (b) Where corrosive gas, such as sulfurous acid gas, is produced. Corroding copper pipes or soldered parts may result in refrigerant leakage.
  - (c) Near machinery emitting electromagnetic waves. Electromagnetic waves may disturb the operation of the control system and cause the unit to malfunction.
  - (d) Where flammable gas may leak, where there is carbon fiber, or ignitable dust suspension in the air, or where volatile flammables such as thinner or gasoline are handled. Operating the unit in such conditions can cause a fire.
- Take adequate measures to prevent the outdoor unit from being used as a shelter by small animals. Small animals making contact with electrical parts can cause malfunctions, smoke, or fire. Instruct the user to keep the area around the unit clean.

### NOTE

- Install the power supply and inter-unit wires for the indoor and outdoor units at least 3.5ft away from televisions or radios to prevent image interference or noise. Depending on the radio waves, a distance of 3.5ft may not be sufficient to eliminate the noise.
- Dismantling the unit, treatment of the refrigerant, oil and additional parts must be done in accordance with the relevant local, state, and national regulations.
- Do not use the following tools that are used with conventional refrigerants: gauge manifold, charge hose, gas leak detector, reverse flow check valve, refrigerant charge base, vacuum gauge, or refrigerant recovery equipment.
- If the conventional refrigerant and refrigerator oil are mixed in R410A, the refrigerant may deteriorate.
- This air conditioner or heat pump is an appliance that should not be accessible to the general public.
- As design pressure is 478 psi, the wall thickness of field-installed pipes should be selected in accordance with the relevant local, state, and national regulations.

# Accessories

Ⓐ Mounting plate	1	Ⓑ Mounting plate fixing screw 3/16" × 1" (M4 × 25mm)	7	Ⓒ Titanium apatite photocatalytic air-purifying filter *1*2	2
Ⓓ Wireless remote controller	1	Ⓔ Remote controller holder	1	Ⓕ Fixing screw for remote controller holder 1/8" × 13/16" (M3 × 20mm)	2
Ⓖ Dry battery AAA. LR03(alkaline)	2	Ⓗ Indoor unit fixing screw 3/16" × 1/2" (M4 × 12mm)	2	Ⓖ Insulation tape	1
Ⓚ Operation manual	1	Ⓛ Installation manual	1	Ⓜ Warranty	1

\*1 Only for FTX(K)09/12/15/18/24\*

\*2 09/12 class: without frame  
15/18/24 class: with frame

## Choosing an Installation Site

Before choosing the installation site, obtain user approval.

### 1. Indoor unit

The indoor unit should be positioned in a place where:

- 1) the restrictions on the installation requirements specified in "Indoor Unit Installation Diagram" on page 4 are met,
- 2) both the air inlet and air outlet are unobstructed,
- 3) the unit is not exposed to direct sunlight,
- 4) the unit is away from sources of heat or steam,
- 5) there is no source of machine oil vapour (this may shorten the indoor unit service life),
- 6) cool/warm air is circulated throughout the room,
- 7) the unit is away from electronic ignition type fluorescent lamps (inverter or rapid start type) as they may affect the remote controller range,
- 8) the unit is at least 3.3ft (1m) away from any television or radio set (the unit may cause interference with the picture or sound),
- 9) no laundry equipment is nearby.

### 2. Wireless remote controller

Turn on all the fluorescent lamps in the room, if any, and find a location where the remote controller signals are properly received by the indoor unit (within 23ft (7m)).

# Indoor Unit Installation Diagram

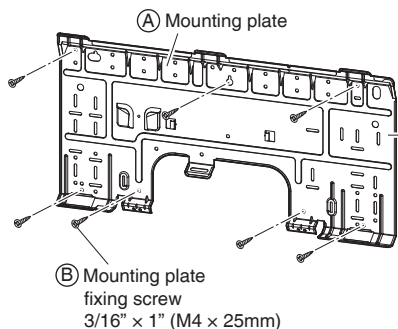

The (A) mounting plate should be installed on a wall which can support the weight of the indoor unit.

### How to attach the indoor unit

Hook the hooks of the bottom frame to the (A) mounting plate. If the hooks are difficult to hook, remove the front grille.

### How to remove the indoor unit

Push up the marked area (at the lower part of the front grille) to release the hooks. If it is difficult to release, remove the front grille.

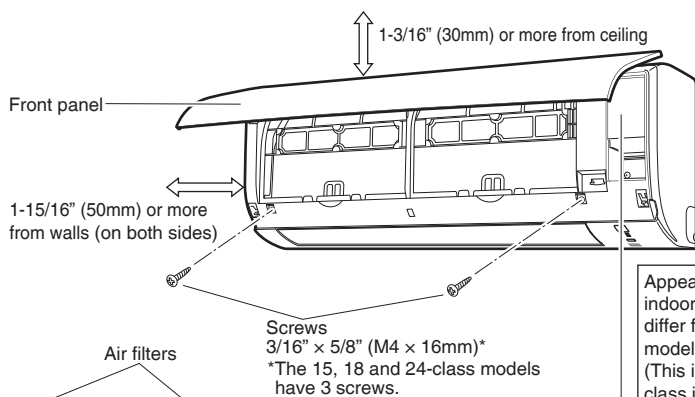
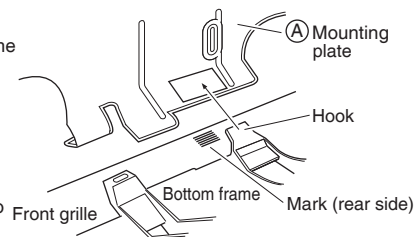

Caulk pipe hole gap with putty.

Cut thermal insulation pipe to an appropriate length and wrap it with tape, making sure that no gap is left in the insulation pipe's cut line.

Appearance of indoor units may differ from some models. (This is a 09/12 class illustration)

Wrap the insulation pipe with the finishing tape from bottom to top.

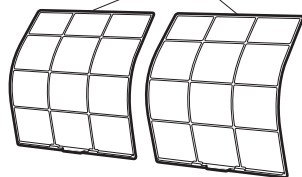

### Service lid

The service lid is removable.

#### Opening method

- 1) Remove the service lid screw.
- 2) Pull out the service lid horizontally in the direction of the arrow.
- 3) Pull down.

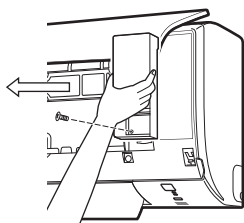

(C) Titanium apatite photocatalytic air-purifying filter (2)  
(FTXN or FTKN models: Sold separately.)

#### 09/12 class

Titanium apatite photocatalytic air-purifying filter

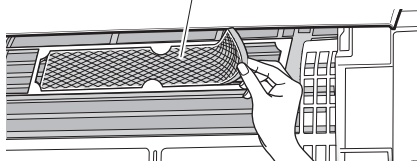

#### 15/18/24 class

Filter frame

Titanium apatite photocatalytic air-purifying filter

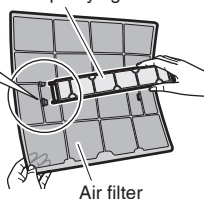
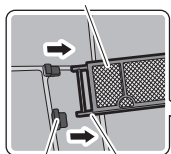

Before screwing the (E) remote controller holder to the wall, make sure that control signals are properly received by indoor unit.

(D) Wireless remote controller

(F) Fixing screw for remote controller holder  
1/8" × 13/16" (M3 × 20mm)

(E) Remote controller holder

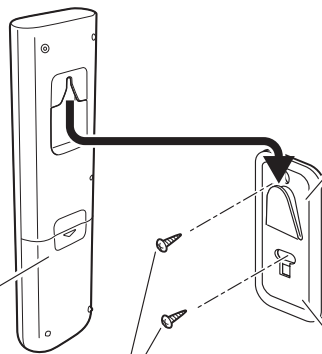

# Indoor Unit Installation

## 1. Installing the mounting plate

- The mounting plate should be installed on a wall which can support the weight of the indoor unit.
  - Temporarily secure the mounting plate to the wall, make sure that the panel is completely level, and mark the drilling points on the wall.
  - Secure the mounting plate to the wall with screws.

### Recommended mounting plate retention spots and dimensions

#### 09/12 class

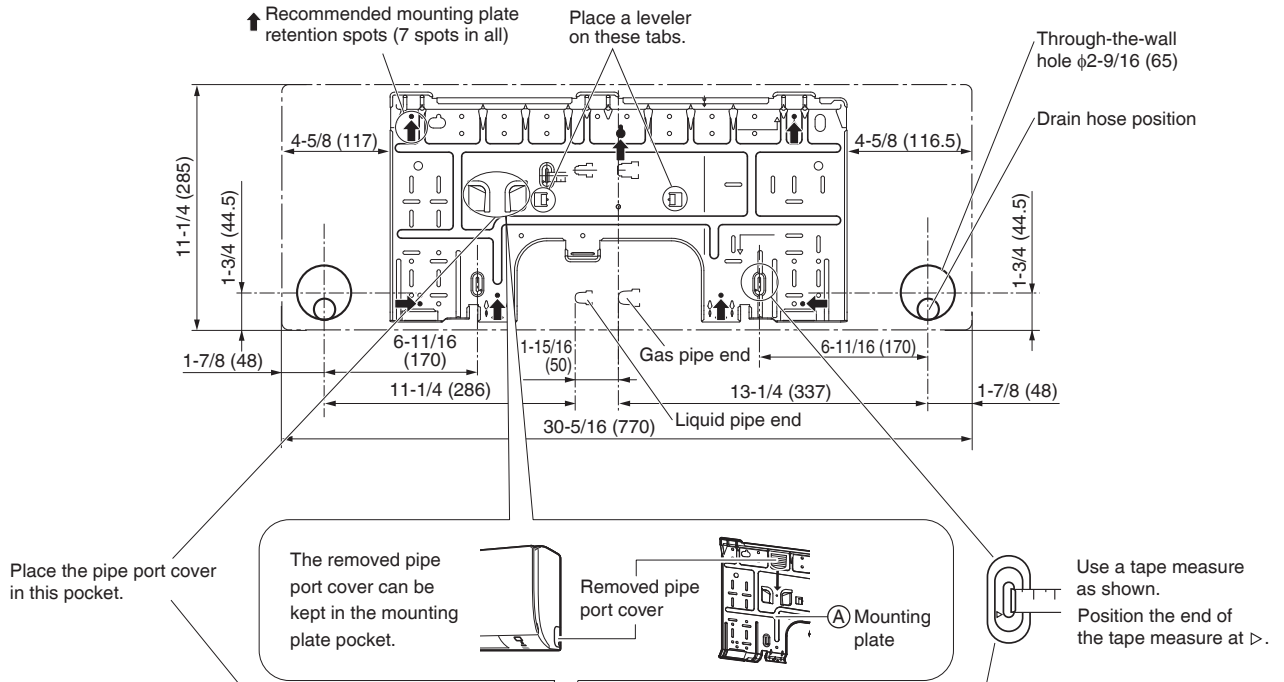

#### 15/18/24 class

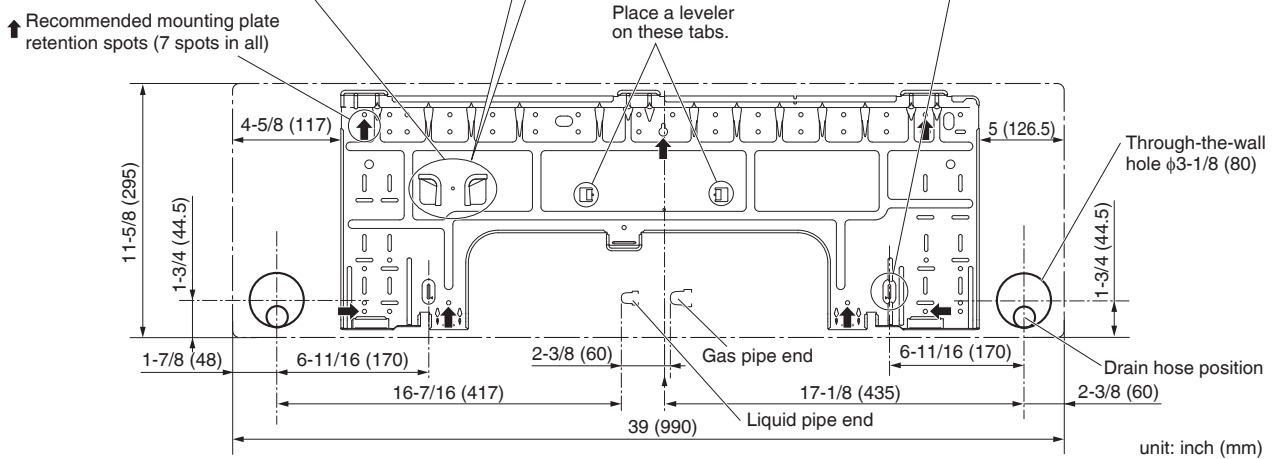

## 2. Drilling a wall hole and installing wall embedded pipe

### ⚠ WARNING

For metal frame or metal board walls, be sure to use a wall embedded pipe and wall hole cover in the feed-through hole to prevent possible heat, electric shock, or fire.

- Be sure to caulk the gaps around the pipes with caulking material to prevent condensation.
  - 1) Drill a feed-through hole with a  $\phi 2\text{-}9/16$  inch (65mm) (for 09/12 class),  $\phi 3\text{-}1/8$  inch (80mm) (for 15/18/24 class) diameter through the wall at a downward angle toward the outside.
  - 2) Insert a wall embedded pipe into the hole.
  - 3) Insert a wall hole cover into wall pipe.
  - 4) After completing refrigerant piping, wiring, and drain piping, caulk the pipe hole gap with putty.

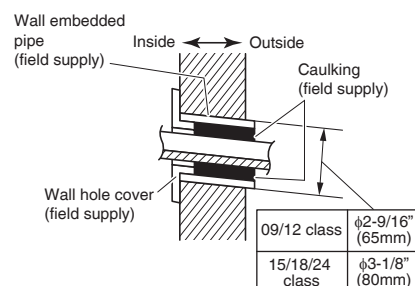

## 3. Installing the indoor unit

In the case of bending or curing refrigerant pipes, keep the following precautions in mind.

Abnormal sound may be generated if improper work is conducted.

- Do not strongly press the refrigerant pipes onto the bottom frame.
- Do not strongly press the refrigerant pipes on the front grille, either.

### 3-1. Right-side, right-back, or right-bottom piping

- 1) Attach the drain hose to the underside of the refrigerant pipes with adhesive vinyl tape.
- 2) Wrap the refrigerant pipes and drain hose together with  $\textcircled{J}$  insulation tape.

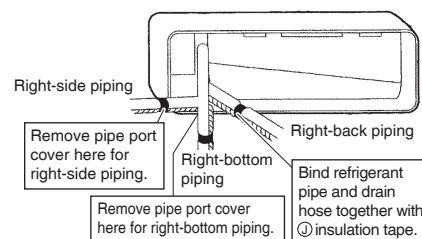

- 3) Pass the drain hose and refrigerant pipes through the wall hole, then set the indoor unit on the  $\textcircled{A}$  mounting plate hooks by using the  $\triangle$  markings at the top of the indoor unit as a guide.

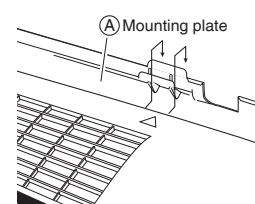

- 4) Open the front panel (Refer to "Installation Tips" on page 10), then open the service lid (Refer to "Indoor Unit Installation Diagram" on page 4).
- 5) Pass the inter-unit wire from the outdoor unit through the feed-through wall hole and pass to the front of indoor unit from the back. Then pull them at front side. Bend the ends of cable tie wires upward for easier work in advance.
- 6) Press the bottom frame of the indoor unit with both hands to set it on the  $\textcircled{A}$  mounting plate hooks. Make sure the wire leads do not catch on the edge of the indoor unit.

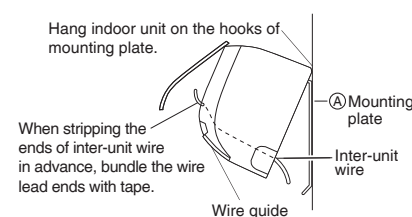



# Indoor Unit Installation

## 3-2. Left-side, left-back, or left-bottom piping

### How to replace the drain plug and drain hose

#### • Replacing onto the left side

- 1) Remove the fixing screw of drain hose on the right and remove the drain hose.
- 2) Remove the drain plug on the left side and attach it to the right side.
- 3) Insert the drain hose and tighten with the included fixing screw.  
Forgetting to tighten this may cause water leakages.

#### Drain hose attachment position

The drain hose is on the back of the unit.

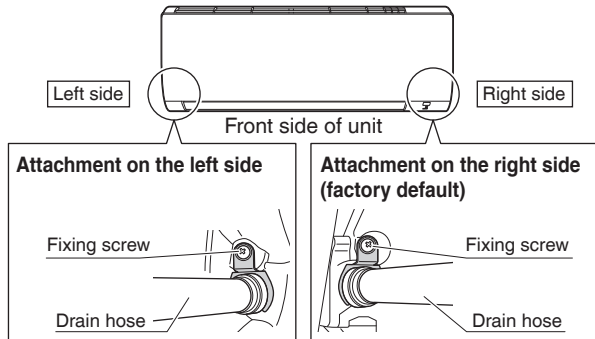

- 1) Attach the drain hose to the underside of the refrigerant pipes with adhesive vinyl tape.

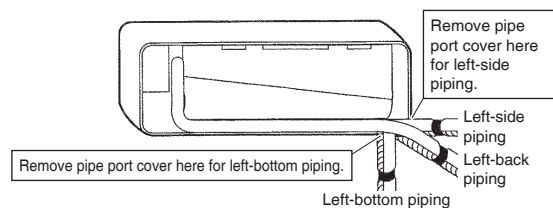

- 2) Be sure to connect the drain plug to the drain port in place of without drain hose.

#### How to set the drain plug.

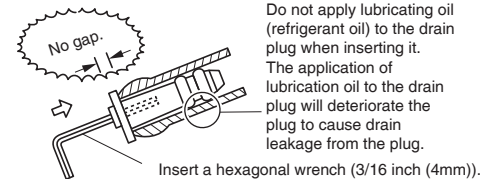

- 3) Shape the refrigerant pipes along the pipe path marking on the (A) mounting plate.
- 4) Pass the drain hose and refrigerant pipes through the wall hole, then position the indoor unit on the (A) mounting plate hooks, using the  $\Delta$  markings at the top of the indoor unit as a guide.
- 5) Pull in the inter-unit wire.
- 6) Connect the refrigerant pipes.

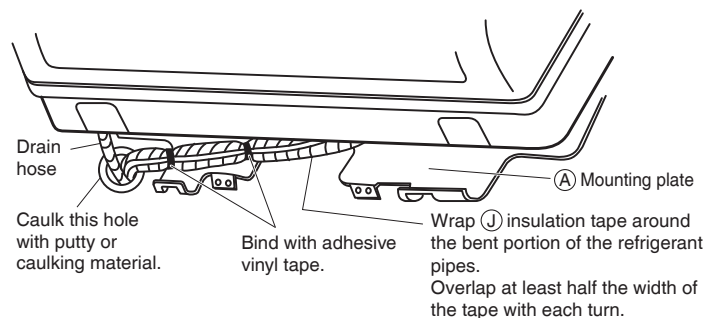

- 7) In case of pulling the drain hose through the back of the indoor unit, wrap the refrigerant pipes and drain hose together with (J) insulation tape as shown in the right figure.
- 8) To confirm that the inter-unit wire does not catch by the indoor unit, press the bottom edge of the indoor unit with both hands until it is firmly caught by the (A) mounting plate hooks. Secure the indoor unit to the mounting plate with the (H) indoor unit fixing screws  $3/16" \times 1/2"$  (M4  $\times$  12mm).

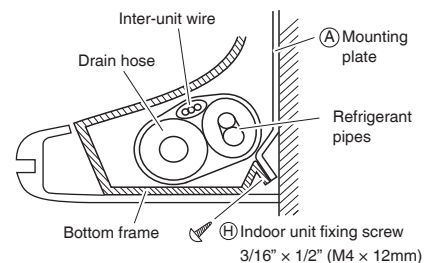

## 3-3. Wall embedded piping

Follow the instructions given under left-side, left-back, or left-bottom piping.

- 1) Insert the drain hose to this depth so it won't be pulled out of the drain pipe.

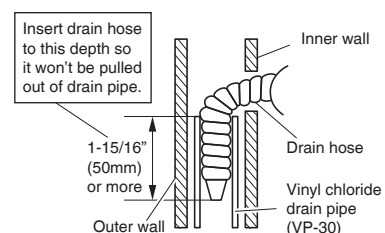



## 4. Wiring

- 1) As shown in the illustration, insert the wires including the ground wire into the conduit and secure them with lock nut onto the conduit mounting plate.
- 2) Strip wire ends (3/4 inch (20mm)).
- 3) Match wire colours with terminal numbers on the terminal block of indoor and outdoor unit and firmly secure the wires in the corresponding terminals with screws.
- 4) Connect the ground wire to the corresponding terminals.
- 5) Pull the wires lightly to make sure they are securely connected.
- 6) While close the service lid, shape the wires so that the service lid fits securely, then close the service lid.

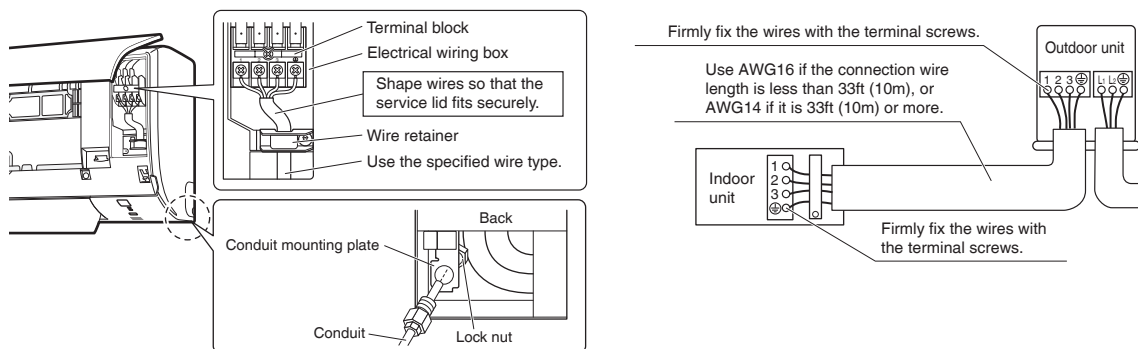

### ⚠ WARNING

- Do not use tapped wires, extension cords, or starburst connections, as they may cause overheating, electric shock, or fire.
- Do not use locally purchased electrical parts inside the product. (Do not branch the power for the drain pump, etc., from the terminal block.) Doing so may cause electric shock or fire.
- Do not connect the power wire to the indoor unit. Doing so may cause electric shock or fire.

## 5. Drain piping

- 1) Connect the drain hose, as described on the right.

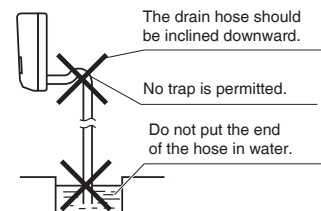

- 2) Remove the air filters and pour some water into the drain pan to check the water flows smoothly.

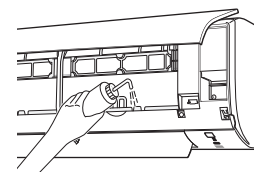

- 3) If drain hose extension or embedded drain piping is required, use appropriate parts that match the hose front end.

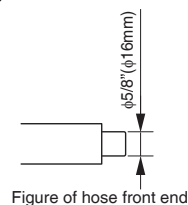

- 4) When extending the drain hose, use a commercially available extension hose with an inner diameter of 5/8 inch (16mm). Be sure to thermally insulate the indoor section of the extension hose.

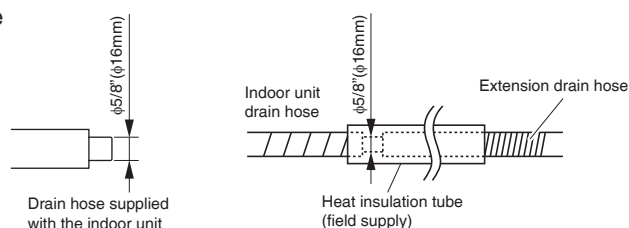

# Refrigerant Piping Work

## 1. Flaring the pipe end

- 1) Cut the pipe end with a pipe cutter.
- 2) Remove burrs with the cut surface facing downward, so that the filings do not enter the pipe.
- 3) Put the flare nut on the pipe.
- 4) Flare the pipe.
- 5) Check that the flaring has been done correctly.

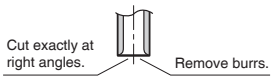

Cut exactly at right angles. Remove burrs.

**Flaring**

Set exactly at the position shown below.

A	Flare tool for R410A	Conventional flare tool	
	Clutch-type	Clutch-type (Rigid-type)	Wing-nut type (Imperial-type)
A	0-0.020 inch (0-0.5mm)	0.039-0.059 inch (1.0-1.5mm)	0.059-0.079 inch (1.5-2.0mm)

**Check**

The flare's inner surface must be flaw-free.

The pipe end must be evenly flared in a perfect circle.

Make sure that the flare nut is fitted.

### ⚠ WARNING

- Do not apply mineral oil to the flare.
- Prevent mineral oil from getting into the system as this would reduce the service life of the units.
- Never use piping which has been used for previous installations. Only use parts which are delivered with this unit.
- Never install a dryer to this R410A unit in order to guarantee its service life.
- The drying material may dissolve and damage the system.
- Incomplete flaring may result in refrigerant gas leakage.

## 2. Refrigerant piping

### ⚠ CAUTION

- Use the flare nut fixed to the main unit. (This is to prevent the flare nut from cracking as a result of deterioration over time.)
- To prevent gas leakage, apply refrigeration oil only to the inner surface of the flare. (Use refrigeration oil for R410A.)
- Use a torque wrench when tightening the flare nuts to prevent damage to the flare nuts and gas leakage.

- Align the centers of both flares and tighten the flare nuts 3 or 4 turns by hand, then tighten them fully with a spanner and a torque wrench.

**Apply oil**

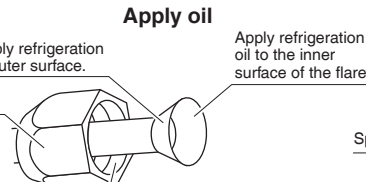

Do not apply refrigeration oil to the outer surface.

Apply refrigeration oil to the inner surface of the flare.

Flare nut

**Tighten**

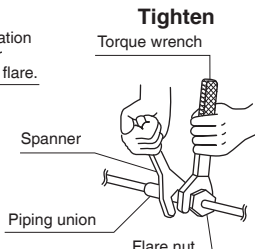

Torque wrench

Spanner

Piping union

Flare nut

Do not apply refrigeration oil to the flare nut to avoid tightening with excessive torque.

	Piping size	Flare nut tightening torque
Gas side	O.D. 3/8 inch (9.5mm)	24-1/8 – 29-1/2ft • lbf (32.7-39.9N • m)
	O.D. 1/2 inch (12.7mm)	36-1/2 – 44-1/2ft • lbf (49.5-60.3N • m)
	O.D. 5/8 inch (15.9mm)	45-5/8 – 55-5/8ft • lbf (61.8-75.4N • m)
Liquid side	O.D. 1/4 inch (6.4mm)	10-1/2 – 12-3/4ft • lbf (14.2-17.2 N • m)

### 2-1. Caution on piping handling

- Protect the open end of the pipe against dust and moisture.
- All pipe bends should be as gentle as possible. Use a pipe bender for bending.

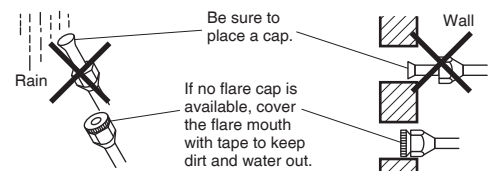

## 2-2. Selection of copper and heat insulation materials

When using commercial copper pipes and fittings, observe the following:

- Insulation material: Polyethylene foam  
Heat transfer rate: 0.041 to 0.052W/mK (0.024 to 0.030Btu/ft<sup>2</sup>h°F (0.035 to 0.045kcal/mh°C))  
Be sure to use insulation that is designed for use with HVAC Systems.
  - ACR Copper only.
- Be sure to insulate both the gas and liquid piping and observe the insulation dimensions as below.

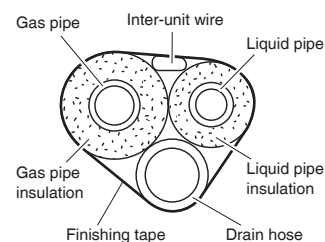

	Piping size	Minimum bend radius	Piping thickness	Thermal insulation size	Thermal insulation thickness
Gas side	O.D. 3/8 inch (9.5mm)	1-3/16 inch (30mm) or more	0.031 inch (0.8mm) (C1220T-O)	I.D. 15/32-19/32 inch (12-15mm)	13/32 inch (10mm) Min.
	O.D. 1/2 inch (12.7mm)	1-9/16 inch (40mm) or more		I.D. 9/16-5/8 inch (14-16mm)	
	O.D. 5/8 inch (15.9mm)	1-15/16 inch (50mm) or more	0.039 inch (1.0mm) (C1220T-O)	I.D. 5/8-13/16 inch (16-20mm)	
Liquid side	O.D. 1/4 inch (6.4mm)	1-3/16 inch (30mm) or more	0.031 inch (0.8mm) (C1220T-O)	I.D. 5/16-13/32 inch (8-10mm)	

- Use separate thermal insulation pipes for gas and liquid refrigerant pipes.

# Installation Tips

## 1. Removing and installing the front panel

### • Removal method

- 1) Place your fingers in the indentations on the main unit (one each on the left and right sides), and open the front panel until it stops.

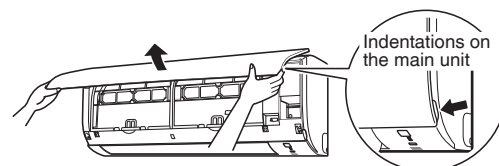

- 2) While pushing the left side front panel shaft outward, push up the front panel and remove it. (Remove the right side front panel shaft in the same manner.)
- 3) After removing both front panel shafts, pull the front panel toward yourself and remove it.

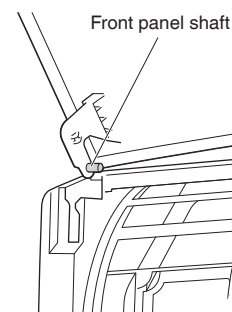

### • Installation method

Align the shaft of the front panel with the grooves of grill, and push all the way in, then close slowly. Push the center of the lower panel surface firmly to engage the hooks.

## 2. Removing and installing the front grille

### • Removal method

- 1) Remove the front panel to remove the air filter.
- 2) Remove the 2 screws from the front grille.  
(The 15, 18 and 24-class models have 3 screws.)
- 3) In front of the ○○○ mark on the front grille, there are 3 upper hooks. Lightly pull the front grille toward you with one hand, and push down on the hooks with the fingers of your other hand.

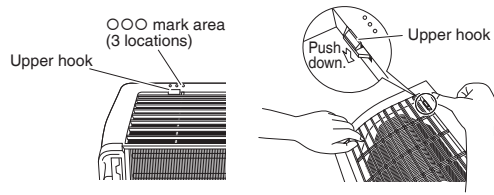

When there is insufficient work space because the unit is close to ceiling

### ⚠ CAUTION

- Be sure to wear protection gloves.

Place both hands under the center of the front grille, and while pushing up, pull it toward you.

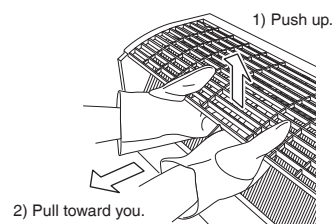

### • Installation method

- 1) Install the front grille and firmly engage the upper hooks (3 locations).
- 2) Install 2 screws of the front grille.  
(The 15, 18 and 24-class models have 3 screws.)
- 3) Install the air filter and then mount the front panel.

## 3. How to set the different addresses

When 2 indoor units are installed in one room, the 2 wireless remote controllers can be set for different addresses. Change the address setting of one of the two units. When cutting the jumper be careful not to damage any of the surrounding parts.

- 1) Remove the battery cover on the remote controller and cut the address jumper.
- 2) Press **TEMP F/C**, **TEMP F/C** and **OFF** at the same time.
- 3) Press **TEMP F/C**, then select **R**, press **FAN**.  
(The indoor unit OPERATION lamp will blink for about 1 minute.)
- 4) Press the indoor unit ON/OFF switch while the OPERATION lamp is blinking.

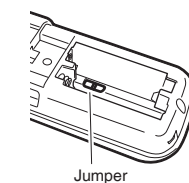

Jumper	ADDRESS
EXIST	1
CUT	2



- If setting could not be carried out completely while the OPERATION lamp was blinking, carry out the setting process once again from the beginning.
- After setting is complete, pressing **FAN** for about 5 seconds will cause the remote controller to return to the previous display.

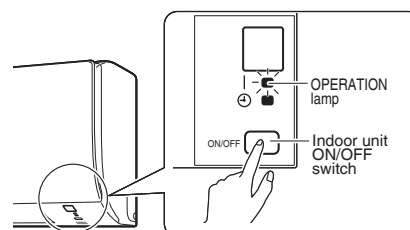

# Trial Operation and Testing

## 1. Trial operation and testing

- Trial operation should be carried out in either COOL or HEAT operation.

**1-1. Measure the supply voltage and make sure that it is within the specified range.**

**1-2. In COOL operation, select the lowest programmable temperature;  
in HEAT operation, select the highest programmable temperature.**



**1-3. Carry out the trial operation following the instructions in the operation manual to ensure that all functions and parts, such as the movement of the flap, are working properly.**

- To protect the air conditioner, restart operation is disabled for 3 minutes after the system has been turned off.

**1-4. After trial operation is complete, set the temperature to a normal level (78°F to 82°F (26°C to 28°C) in COOL operation, 68°F to 75°F (20°C to 24°C) in HEAT operation).**

- When operating the air conditioner in COOL operation in winter, or HEAT operation in summer, set it to the trial operation mode using the following method.

1) Press ,  and  at the same time.

2) Press , then select , press .

3) Press  or  to turn on the system.

- Trial operation will stop automatically after about 30 minutes. To stop the operation, press .
- Some of the functions cannot be used in the trial operation mode.



HEAT PUMP model

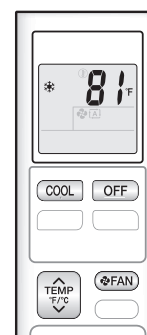

COOLING ONLY model

- The air conditioner draws a small amount of power in its standby mode. If the system is not to be used for some time after installation, shut off the circuit breaker to eliminate unnecessary power consumption.
- If the circuit breaker trips to shut off the power to the air conditioner, the system will restore the original operation mode when the circuit breaker is opened again.

## 2. Test items

Test items	Symptom	Check
Indoor and outdoor units are installed properly on solid bases.	Fall, vibration, noise	
No refrigerant gas leaks.	Incomplete cooling/heating function	
Refrigerant gas and liquid pipes and indoor drain hose extension are thermally insulated.	Water leakage	
Draining line is properly installed.	Water leakage	
System is properly grounded.	Electrical leakage	
The specified wires are used for inter-unit wiring.	No operation or burn damage	
Indoor or outdoor unit's air inlet or air outlet are unobstructed.	Incomplete cooling/heating function	
Stop valves are opened.	Incomplete cooling/heating function	
Indoor unit properly receives remote control commands.	No operation	

**GOODMAN MANUFACTURING COMPANY, L.P.**

5151 San Felipe, Suite 500  
Houston, TX 77056 USA

**DAIKIN INDUSTRIES, LTD.**

Head office:  
Umeda Center Bldg., 2-4-12, Nakazaki-Nishi,  
Kita-ku, Osaka, 530-8323 Japan

Tokyo office:  
JR Shinagawa East Bldg., 2-18-1, Konan,  
Minato-ku, Tokyo, 108-0075 Japan  
<http://www.daikin.com>



**Intertek**



Two-dimensional bar code  
is a manufacturing code.

3P379970-5B

M15B134 (1510) HT