

Service Manual

Inverter Pair Wall Mounted Type FTK(X)N-N, FTK(X)-N Series

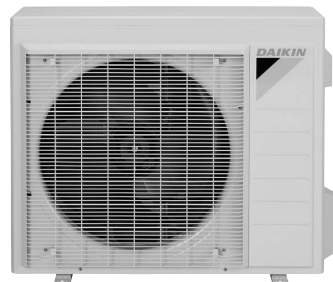
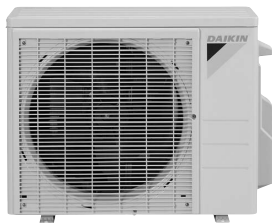
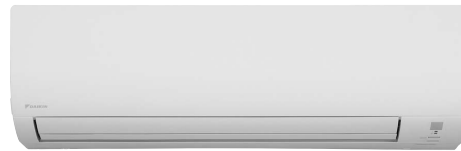
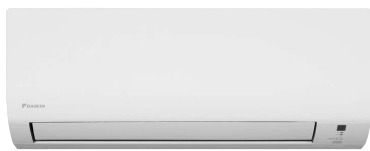

[Applied Models]

- Inverter Pair : Cooling Only
- Inverter Pair : Heat Pump

Inverter Pair Wall Mounted Type FTK(X)N-N, FTK(X)-N Series

●Cooling Only

Indoor Unit

FTKN09NMVJU	FTK09NMVJU
FTKN12NMVJU	FTK12NMVJU
FTKN18NMVJU	FTK18NMVJU
FTKN24NMVJU	FTK24NMVJU

Outdoor Unit

RKN09NMVJU	RK09NMVJU
RKN12NMVJU	RK12NMVJU
RKN18NMVJU	RK18NMVJU
RKN24NMVJU	RK24NMVJU

●Heat Pump

Indoor Unit

FTXN09NMVJU	FTX09NMVJU
FTXN12NMVJU	FTX12NMVJU
FTXN18NMVJU	FTX18NMVJU
FTXN24NMVJU	FTX24NMVJU

Outdoor Unit

RXN09NMVJU	RX09NMVJU
RXN12NMVJU	RX12NMVJU
RXN18NMVJU	RX18NMVJU
RXN24NMVJU	RX24NMVJU

1. Safety Cautions.....	V
1.1 Warnings and Cautions Regarding Safety of Workers.....	v
1.2 Warnings and Cautions Regarding Safety of Users.....	vii
2. Used Icons	x
Part 1 List of Functions	1
1. Functions.....	2
Part 2 Specifications	6
1. Specifications	7
1.1 Cooling Only.....	7
1.2 Heat Pump	11
Part 3 Printed Circuit Board Connector Wiring Diagram	15
1. Indoor Unit.....	16
1.1 09/12 Class	16
1.2 18/24 Class	18
2. Outdoor Unit.....	20
2.1 09/12 Class, RKN18NMVJU	20
2.2 RXN18NMVJU, RK(X)18NMVJU, 24 class	21
Part 4 Function and Control.....	22
1. Main Functions.....	23
1.1 Temperature Control	23
1.2 Frequency Principle.....	23
1.3 Airflow Direction Control.....	25
1.4 Fan Speed Control for Indoor Unit	26
1.5 Program Dry Operation	27
1.6 Automatic Operation.....	28
1.7 Thermostat Control.....	29
1.8 NIGHT SET Mode	30
1.9 ECONO Operation	30
1.10 Inverter POWERFUL Operation	31
1.11 Other Functions.....	32
2. Function of Thermistor	33
3. Control Specification	34
3.1 Mode Hierarchy	34
3.2 Frequency Control.....	35
3.3 Controls at Mode Changing / Start-up.....	37
3.4 Discharge Pipe Temperature Control.....	39
3.5 Input Current Control.....	40
3.6 Freeze-up Protection Control	41
3.7 Heating Peak-cut Control	41
3.8 Outdoor Fan Control.....	42
3.9 Liquid Compression Protection Function.....	42

3.10 Defrost Control	43
3.11 Electronic Expansion Valve Control	44
3.12 Malfunctions	47

Part 5 Remote Controller 48

1. Cooling Only.....	49
2. Heat Pump	51

Part 6 Service Diagnosis..... 53

1. General Problem Symptoms and Check Items	55
2. Troubleshooting with LED	56
2.1 Indoor Unit.....	56
2.2 Outdoor Unit.....	56
3. Service Diagnosis	57
4. Troubleshooting	60
4.1 Error Codes and Description	60
4.2 Indoor Unit PCB Abnormality	61
4.3 Freeze-up Protection Control / Heating Peak-cut Control	62
4.4 Fan Motor (DC Motor) or Related Abnormality.....	63
4.5 Thermistor or Related Abnormality (Indoor Unit).....	65
4.6 Low-voltage Detection or Over-voltage Detection.....	66
4.7 Signal Transmission Error (between Indoor Unit and Outdoor Unit).....	68
4.8 Unspecified Voltage (Between Indoor Unit and Outdoor Unit)	70
4.9 Outdoor Unit PCB Abnormality.....	71
4.10 OL Activation (Compressor Overload)	72
4.11 Compressor Lock	74
4.12 DC Fan Lock	75
4.13 Input Overcurrent Detection	76
4.14 Four Way Valve Abnormality.....	77
4.15 Discharge Pipe Temperature Control.....	79
4.16 High Pressure Control in Cooling	80
4.17 Compressor System Sensor Abnormality	82
4.18 Position Sensor Abnormality	83
4.19 Thermistor or Related Abnormality (Outdoor Unit).....	85
4.20 Electrical Box Temperature Rise.....	87
4.21 Radiation Fin Temperature Rise	88
4.22 Output Overcurrent Detection	89
5. Check	91
5.1 Thermistor Resistance Check	91
5.2 Fan Motor Connector Output Check	92
5.3 Power Supply Waveforms Check.....	93
5.4 Electronic Expansion Valve Check.....	93
5.5 Four Way Valve Performance Check	94
5.6 Inverter Unit Refrigerant System Check.....	94
5.7 Inverter Analyzer Check.....	95
5.8 Rotation Pulse Check on the Outdoor Unit PCB.....	97

5.9	Installation Condition Check.....	98
5.10	Discharge Pressure Check.....	98
5.11	Outdoor Fan System Check.....	99
5.12	Main Circuit Short Check.....	99
5.13	Power Module Check	100

Part 7 Trial Operation and Field Settings..... 102

1.	Tips for Servicing	103
1.1	Pump Down Operation	103
1.2	Forced Cooling Operation	103
2.	Trial Operation	104
3.	Field Settings	105
3.1	Temperature Display Switch	105
3.2	When 2 Units are Installed in 1 Room.....	106
3.3	Facility Setting Switch (cooling at low outdoor temperature) (Only for RK(X) series)	107
4.	Silicon Grease on Power Transistor / Diode Bridge	108





Part 8 Appendix..... 109

1.	Piping Diagrams.....	110
1.1	Indoor unit	110
1.2	Outdoor Unit.....	112
2.	Wiring Diagrams.....	118
2.1	Indoor Unit.....	118
2.2	Outdoor Unit.....	119



1. Safety Cautions

Be sure to read the following safety cautions before conducting repair work. After the repair work is complete, be sure to conduct a test operation to ensure that the equipment operates normally, and explain the cautions for operating the product to the customer.







Caution Items





The caution items are classified into  **Warning** and  **Caution**. The  **Warning** items are especially important since they can lead to death or serious injury if they are not followed closely. The  **Caution** items can also lead to serious accidents under some conditions if they are not followed. Therefore, be sure to observe all the safety caution items described below.







Pictograms



-  This symbol indicates the item for which caution must be exercised. The pictogram shows the item to which attention must be paid.
-  This symbol indicates the prohibited action. The prohibited item or action is shown in the illustration or near the symbol.
-  This symbol indicates the action that must be taken, or the instruction. The instruction is shown in the illustration or near the symbol.

1.1 Warnings and Cautions Regarding Safety of Workers







 Warning	
Do not store the equipment in a room with successive fire sources (e.g., naked flame, gas appliance, electric heater).	
Be sure to disconnect the power cable plug from the plug socket before disassembling the equipment for repair. Working on the equipment that is connected to the power supply may cause an electrical shock. If it is necessary to supply power to the equipment to conduct the repair or inspecting the circuits, do not touch any electrically charged sections of the equipment.	
If the refrigerant gas is discharged during the repair work, do not touch the discharged refrigerant gas. The refrigerant gas may cause frostbite.	
When disconnecting the suction or discharge pipe of the compressor at the welded section, evacuate the refrigerant gas completely at a well-ventilated place first. If there is gas remaining inside the compressor, the refrigerant gas or refrigerating machine oil discharges when the pipe is disconnected, and it may cause injury.	
If the refrigerant gas leaks during the repair work, ventilate the area. The refrigerant gas may generate toxic gases when it contacts flames.	
Be sure to discharge the capacitor completely before conducting repair work. The step-up capacitor supplies high-voltage electricity to the electrical components of the outdoor unit. A charged capacitor may cause an electrical shock.	











 Warning	
<p>Do not start or stop the air conditioner operation by plugging or unplugging the power cable plug. Plugging or unplugging the power cable plug to operate the equipment may cause an electrical shock or fire.</p>	
<p>Be sure to wear a safety helmet, gloves, and a safety belt when working at a high place (more than 2 m). Insufficient safety measures may cause a fall accident.</p>	
<p>In case of R-32 / R-410A refrigerant models, be sure to use pipes, flare nuts and tools for the exclusive use of the R-32 / R-410A refrigerant. The use of materials for R-22 refrigerant models may cause a serious accident such as a damage of refrigerant cycle as well as an equipment failure.</p>	
<p>Do not mix air or gas other than the specified refrigerant (R-32 / R-410A / R-22) in the refrigerant system. If air enters the refrigerating system, an excessively high pressure results, causing equipment damage and injury.</p>	











 Caution	
<p>Do not repair the electrical components with wet hands. Working on the equipment with wet hands may cause an electrical shock.</p>	
<p>Do not clean the air conditioner by splashing water. Washing the unit with water may cause an electrical shock.</p>	
<p>Be sure to provide the earth / grounding when repairing the equipment in a humid or wet place, to avoid electrical shocks.</p>	
<p>Be sure to turn off the power switch and unplug the power cable when cleaning the equipment. The internal fan rotates at a high speed, and may cause injury.</p>	
<p>Be sure to conduct repair work with appropriate tools. The use of inappropriate tools may cause injury.</p>	

 Caution	
Be sure to check that the refrigerating cycle section has cooled down enough before conducting repair work. Working on the unit when the refrigerating cycle section is hot may cause burns.	
Use the welder in a well-ventilated place. Using the welder in an enclosed room may cause oxygen deficiency.	

1.2 Warnings and Cautions Regarding Safety of Users





 Warning	
Do not store the equipment in a room with successive fire sources (e.g., naked flame, gas appliance, electric heater).	
Be sure to use parts listed in the service parts list of the applicable model and appropriate tools to conduct repair work. Never attempt to modify the equipment. The use of inappropriate parts or tools may cause an electrical shock, excessive heat generation or fire.	
If the power cable and lead wires have scratches or deteriorated, be sure to replace them. Damaged cable and wires may cause an electrical shock, excessive heat generation or fire.	
Do not use a joined power cable or extension cable, or share the same power outlet with other electrical appliances, since it may cause an electrical shock, excessive heat generation or fire.	
Be sure to use an exclusive power circuit for the equipment, and follow the local technical standards related to the electrical equipment, the internal wiring regulations, and the instruction manual for installation when conducting electrical work. Insufficient power circuit capacity and improper electrical work may cause an electrical shock or fire.	
Be sure to use the specified cable for wiring between the indoor and outdoor units. Make the connections securely and route the cable properly so that there is no force pulling the cable at the connection terminals. Improper connections may cause excessive heat generation or fire.	

 Warning	
<p>When wiring between the indoor and outdoor units, make sure that the terminal cover does not lift off or dismount because of the cable. If the cover is not mounted properly, the terminal connection section may cause an electrical shock, excessive heat generation or fire.</p>	
<p>Do not damage or modify the power cable. Damaged or modified power cable may cause an electrical shock or fire. Placing heavy items on the power cable, and heating or pulling the power cable may damage the cable.</p>	
<p>Do not mix air or gas other than the specified refrigerant (R-32 / R-410A / R-22) in the refrigerant system. If air enters the refrigerating system, an excessively high pressure results, causing equipment damage and injury.</p>	
<p>If the refrigerant gas leaks, be sure to locate the leaking point and repair it before charging the refrigerant. After charging refrigerant, make sure that there is no refrigerant leak. If the leaking point cannot be located and the repair work must be stopped, be sure to perform pump-down and close the service valve, to prevent the refrigerant gas from leaking into the room. The refrigerant gas itself is harmless, but it may generate toxic gases when it contacts flames, such as fan and other heaters, stoves and ranges.</p>	
<p>When relocating the equipment, make sure that the new installation site has sufficient strength to withstand the weight of the equipment. If the installation site does not have sufficient strength and if the installation work is not conducted securely, the equipment may fall and cause injury.</p>	
<p>Check to make sure that the power cable plug is not dirty or loose, then insert the plug into a power outlet securely. If the plug has dust or loose connection, it may cause an electrical shock or fire.</p>	
<p>Be sure to install the product correctly by using the provided standard installation frame. Incorrect use of the installation frame and improper installation may cause the equipment to fall, resulting in injury.</p>	For unitary type only 
<p>Be sure to install the product securely in the installation frame mounted on the window frame. If the unit is not securely mounted, it may fall and cause injury.</p>	For unitary type only 
<p>When replacing the coin battery in the remote controller, be sure to dispose of the old battery to prevent children from swallowing it. If a child swallows the coin battery, see a doctor immediately.</p>	

 Caution	
<p>Installation of a leakage breaker is necessary in some cases depending on the conditions of the installation site, to prevent electrical shocks.</p>	
<p>Do not install the equipment in a place where there is a possibility of combustible gas leaks. If the combustible gas leaks and remains around the unit, it may cause a fire.</p>	
<p>Check to see if the parts and wires are mounted and connected properly, and if the connections at the soldered or crimped terminals are secure. Improper installation and connections may cause excessive heat generation, fire or an electrical shock.</p>	
<p>If the installation platform or frame has corroded, replace it. Corroded installation platform or frame may cause the unit to fall, resulting in injury.</p>	
<p>Check the earth / grounding, and repair it if the equipment is not properly earthed / grounded. Improper earth / grounding may cause an electrical shock.</p>	
<p>Be sure to measure the insulation resistance after the repair, and make sure that the resistance is 1 MΩ or higher. Faulty insulation may cause an electrical shock.</p>	
<p>Be sure to check the drainage of the indoor unit after the repair. Faulty drainage may cause the water to enter the room and wet the furniture and floor.</p>	
<p>Do not tilt the unit when removing it. The water inside the unit may spill and wet the furniture and floor.</p>	
<p>Be sure to install the packing and seal on the installation frame properly. If the packing and seal are not installed properly, water may enter the room and wet the furniture and floor.</p>	<p>For unitary type only</p> <p style="text-align: center;">  </p>

2. Used Icons

The following icons are used to attract the attention of the reader to specific information.

Icon	Type of Information	Description
 Warning	Warning	A Warning is used when there is danger of personal injury.
 Caution	Caution	A Caution is used when there is danger that the reader, through incorrect manipulation, may damage equipment, lose data, get an unexpected result or has to restart (part of) a procedure.
 Note:	Note	A Note provides information that is not indispensable, but may nevertheless be valuable to the reader, such as tips and tricks.
	Reference	A Reference guides the reader to other places in this binder or in this manual, where he/she will find additional information on a specific topic.

Part 1

List of Functions

1. Functions.....2

1. Functions

Category	Functions	FTKN09/12NMVJU RKN09/12NMVJU		Category	Functions	FTKN09/12NMVJU RKN09/12NMVJU	
		FTKN09/12NMVJU RKN09/12NMVJU	FTXN09/12NMVJU RXN09/12NMVJU			FTKN09/12NMVJU RKN09/12NMVJU	FTXN09/12NMVJU RXN09/12NMVJU
Basic Function	Inverter (with inverter power control)	●	●	Health & Clean	Air-purifying filter	—	—
	Operation limit for cooling (°CDB)	10 ~ 46	10 ~ 46		Photocatalytic deodorizing filter	—	—
	Operation limit for cooling (°FDB)	50 ~ 114.8	50 ~ 114.8		Air-purifying filter with photocatalytic deodorizing function	—	—
	Operation limit for heating (°CWB)	—	-15 ~ 18		Titanium apatite photocatalytic air-purifying filter (option)	●	●
	Operation limit for heating (°FWB)	—	5 ~ 64.4		Air filter (prefilter)	●	●
	PAM control	●	●		Wipe-clean flat panel	●	●
	Standby electricity saving	●	●		Washable grille	—	—
Compressor	Oval scroll compressor	—	—	Timer	WEEKLY TIMER	—	—
	Swing compressor	●	●		Count up-down ON/OFF timer	●	●
	Rotary compressor	—	—		24-hour ON/OFF TIMER	—	—
	Reluctance DC motor	●	●		NIGHT SET mode	●	●
Comfortable Airflow	Power-airflow flap (horizontal blade)	●	●	Worry Free (Reliability & Durability)	Auto-restart (after power failure)	●	●
	Power-airflow dual flaps	—	—		Self-diagnosis (R/C, LED)	●	●
	Power-airflow diffuser	—	—		Wiring error check function	—	—
	Wide-angle louvers (vertical blade)	●	●		Anti-corrosion treatment of outdoor heat exchanger	●	●
	Auto-swing (up and down)	●	●	Flexibility	Multi-split / split type compatible indoor unit	—	—
	Auto-swing (right and left)	—	—		H/P, C/O compatible indoor unit	—	—
	3-D airflow	—	—		Flexible power supply correspondence	—	—
Comfort Control	COMFORT AIRFLOW operation	●	●	Chargeless	32.8 ft (10 m)	32.8 ft (10 m)	
	Auto fan speed	●	●	Either side drain (right or left)	●	●	
	Indoor unit quiet operation	●	●	Power selection	—	—	
	NIGHT QUIET mode (automatic)	—	—	Low temperature cooling operation (-15°C) (5°F)	—	—	
	OUTDOOR UNIT QUIET operation (manual)	—	—	°F/°C changeover R/C temperature display (factory setting: °F)	●	●	
	INTELLIGENT EYE operation	—	—	Remote Control	5-rooms centralized controller (option)	●	●
	Quick warming function	—	●		Remote control adaptor (normal open-pulse contact) (option)	●	●
	Hot-start function	—	●		Remote control adaptor (normal open contact) (option)	●	●
Automatic defrosting	—	●	DIII-NET compatible (adaptor) (option)		●	●	
Operation	Automatic operation	—	●	Remote Controller	Wireless	●	●
	Program dry function	●	●		Wired (option)	●	●
	Fan only	●	●				
Lifestyle Convenience	New POWERFUL operation (non-inverter)	—	—				
	Inverter POWERFUL operation	●	●				
	Priority-room setting	—	—				
	COOL / HEAT mode lock	—	—				
	HOME LEAVE operation	—	—				
	ECONO operation	●	●				
	Indoor unit ON/OFF button	●	●				
	Signal receiving sign	●	●				
R/C with back light	—	—					
Temperature display	—	—					

Note: ● : Available
— : Not available

Category	Functions	FTKN18/24NMVJU RKN18/24NMVJU	FTXN18/24NMVJU RXN18/24NMVJU	Category	Functions	FTKN18/24NMVJU RKN18/24NMVJU	FTXN18/24NMVJU RXN18/24NMVJU	
Basic Function	Inverter (with inverter power control)	●	●	Health & Clean	Air-purifying filter	—	—	
	Operation limit for cooling (°CDB)	10 ~ 46	10 ~ 46		Photocatalytic deodorizing filter	—	—	
	Operation limit for cooling (°FDB)	50 ~ 114.8	50 ~ 114.8		Air-purifying filter with photocatalytic deodorizing function	—	—	
	Operation limit for heating (°CWB)	—	-15 ~ 18		Titanium apatite photocatalytic air-purifying filter (option)	●	●	
	Operation limit for heating (°FWB)	—	5 ~ 64.4		Air filter (prefilter)	●	●	
	PAM control	●	●		Wipe-clean flat panel	●	●	
	Standby electricity saving	●	●		Washable grille	—	—	
Compressor	Oval scroll compressor	—	—	Timer	WEEKLY TIMER	—	—	
	Swing compressor	●	●		Count up-down ON/OFF timer	●	●	
	Rotary compressor	—	—		24-hour ON/OFF TIMER	—	—	
	Reluctance DC motor	●	●		NIGHT SET mode	●	●	
Comfortable Airflow	Power-airflow flap (horizontal blade)	—	—	Worry Free (Reliability & Durability)	Auto-restart (after power failure)	●	●	
	Power-airflow dual flaps	●	●		Self-diagnosis (R/C, LED)	●	●	
	Power-airflow diffuser	—	—		Wiring error check function	—	—	
	Wide-angle louvers (vertical blade)	●	●		Anti-corrosion treatment of outdoor heat exchanger	●	●	
	Auto-swing (up and down)	●	●	Flexibility	Multi-split / split type compatible indoor unit	—	—	
	Auto-swing (right and left)	—	—		H/P, C/O compatible indoor unit	—	—	
	3-D airflow	—	—		Flexible power supply correspondence	—	—	
Comfort Control	COMFORT AIRFLOW operation	●	●	Remote Control	Chargeless	32.8 ft (10 m)	32.8 ft (10 m)	
	Auto fan speed	●	●		Either side drain (right or left)	●	●	
	Indoor unit quiet operation	●	●		Power selection	—	—	
	NIGHT QUIET mode (automatic)	—	—		Low temperature cooling operation (-15°C) (5°F)	—	—	
	OUTDOOR UNIT QUIET operation (manual)	—	—		°F/°C changeover R/C temperature display (factory setting: °F)	●	●	
	INTELLIGENT EYE operation	—	—		Remote Controller	5-rooms centralized controller (option)	●	●
	Quick warming function	—	●			Remote control adaptor (normal open-pulse contact) (option)	●	●
	Hot-start function	—	●			Remote control adaptor (normal open contact) (option)	●	●
Automatic defrosting	—	●	DIII-NET compatible (adaptor) (option)	●		●		
Operation	Automatic operation	—	●	Remote Controller	Wireless	●	●	
	Program dry function	●	●		Wired (option)	●	●	
	Fan only	●	●					
Lifestyle Convenience	New POWERFUL operation (non-inverter)	—	—					
	Inverter POWERFUL operation	●	●					
	Priority-room setting	—	—					
	COOL / HEAT mode lock	—	—					
	HOME LEAVE operation	—	—					
	ECONO operation	●	●					
	Indoor unit ON/OFF button	●	●					
	Signal receiving sign	●	●					
R/C with back light	—	—						
Temperature display	—	—						

Note: ● : Available
 — : Not available

Category	Functions	FTK09/12NMVJU RK09/12NMVJU	FTX09/12NMVJU RX09/12NMVJU	Category	Functions	FTK09/12NMVJU RK09/12NMVJU	FTX09/12NMVJU RX09/12NMVJU
Basic Function	Inverter (with inverter power control)	●	●	Health & Clean	Air-purifying filter	—	—
	Operation limit for cooling (°CDB)	10 ~ 46	10 ~ 46		Photocatalytic deodorizing filter	—	—
	Operation limit for cooling (°FDB)	50 ~ 114.8	50 ~ 114.8		Air-purifying filter with photocatalytic deodorizing function	—	—
	Operation limit for heating (°CWB)	—	-15 ~ 18		Titanium apatite photocatalytic air-purifying filter (option)	●	●
	Operation limit for heating (°FWB)	—	5 ~ 64.4		Air filter (prefilter)	●	●
	PAM control	●	●		Wipe-clean flat panel	●	●
	Standby electricity saving	●	●		Washable grille	—	—
Compressor	Oval scroll compressor	—	—	Timer	MOLD PROOF operation	—	—
	Swing compressor	●	●		Good-sleep cooling operation	—	—
	Rotary compressor	—	—		WEEKLY TIMER	—	—
	Reluctance DC motor	●	●		Count up-down ON/OFF timer	●	●
Comfortable Airflow	Power-airflow flap (horizontal blade)	●	●	Worry Free (Reliability & Durability)	24-hour ON/OFF TIMER	—	—
	Power-airflow dual flaps	—	—		NIGHT SET mode	●	●
	Power-airflow diffuser	—	—		Auto-restart (after power failure)	●	●
	Wide-angle louvers (vertical blade)	●	●	Flexibility	Self-diagnosis (R/C, LED)	●	●
	Auto-swing (up and down)	●	●		Wiring error check function	—	—
	Auto-swing (right and left)	—	—		Anti-corrosion treatment of outdoor heat exchanger	●	●
	3-D airflow	—	—		Multi-split / split type compatible indoor unit	—	—
Comfort Control	COMFORT AIRFLOW operation	●	●	H/P, C/O compatible indoor unit	—	—	
	Auto fan speed	●	●	Flexible power supply correspondence	—	—	
	Indoor unit quiet operation	●	●	Chargeless	32.8 ft (10 m)	32.8 ft (10 m)	
	NIGHT QUIET mode (automatic)	—	—	Either side drain (right or left)	●	●	
	OUTDOOR UNIT QUIET operation (manual)	—	—	Power selection	—	—	
	INTELLIGENT EYE operation	—	—	Low temperature cooling operation (-15°C) (5°F)	●	●	
	Quick warming function	—	●	°F/°C changeover R/C temperature display (factory setting: °F)	●	●	
	Hot-start function	—	●	Remote Control	5-rooms centralized controller (option)	●	●
Automatic defrosting	—	●	Remote control adaptor (normal open-pulse contact) (option)		●	●	
Operation	Automatic operation	—	●		Remote control adaptor (normal open contact) (option)	●	●
	Program dry function	●	●	DIII-NET compatible (adaptor) (option)	●	●	
	Fan only	●	●	Remote Controller	Wireless	●	●
	Lifestyle Convenience	New POWERFUL operation (non-inverter)	—		—	Wired (option)	●
		Inverter POWERFUL operation	●	●			
		Priority-room setting	—	—			
		COOL / HEAT mode lock	—	—			
		HOME LEAVE operation	—	—			
		ECONO operation	●	●			
		Indoor unit ON/OFF button	●	●			
Signal receiving sign		●	●				
R/C with back light	●	●					
Temperature display	—	—					

Note: ● : Available
— : Not available

Category	Functions	FTK18/24NMVJU RK18/24NMVJU	FTX18/24NMVJU RX18/24NMVJU	Category	Functions	FTK18/24NMVJU RK18/24NMVJU	FTX18/24NMVJU RX18/24NMVJU	
Basic Function	Inverter (with inverter power control)	●	●	Health & Clean	Air-purifying filter	—	—	
	Operation limit for cooling (°CDB)	10 ~ 46	10 ~ 46		Photocatalytic deodorizing filter	—	—	
	Operation limit for cooling (°FDB)	50 ~ 114.8	50 ~ 114.8		Air-purifying filter with photocatalytic deodorizing function	—	—	
	Operation limit for heating (°CWB)	—	-15 ~ 18		Titanium apatite photocatalytic air-purifying filter (option)	●	●	
	Operation limit for heating (°FWB)	—	5 ~ 64.4		Air filter (prefilter)	●	●	
	PAM control	●	●		Wipe-clean flat panel	●	●	
	Standby electricity saving	●	●		Washable grille	—	—	
Compressor	Oval scroll compressor	—	—	Timer	MOLD PROOF operation	—	—	
	Swing compressor	●	●		Good-sleep cooling operation	—	—	
	Rotary compressor	—	—		WEEKLY TIMER	—	—	
	Reluctance DC motor	●	●		Count up-down ON/OFF timer	●	●	
Comfortable Airflow	Power-airflow flap (horizontal blade)	—	—	Worry Free (Reliability & Durability)	24-hour ON/OFF TIMER	—	—	
	Power-airflow dual flaps	●	●		NIGHT SET mode	●	●	
	Power-airflow diffuser	—	—		Auto-restart (after power failure)	●	●	
	Wide-angle louvers (vertical blade)	●	●		Self-diagnosis (R/C, LED)	●	●	
	Auto-swing (up and down)	●	●	Wiring error check function	—	—		
	Auto-swing (right and left)	—	—	Anti-corrosion treatment of outdoor heat exchanger	●	●		
	3-D airflow	—	—	Flexibility	Multi-split / split type compatible indoor unit	—	—	
COMFORT AIRFLOW operation	●	●	H/P, C/O compatible indoor unit		—	—		
Comfort Control	Auto fan speed	●	●		Flexible power supply correspondence	—	—	
	Indoor unit quiet operation	●	●	Chargeless	32.8 ft (10 m)	32.8 ft (10 m)		
	NIGHT QUIET mode (automatic)	—	—	Either side drain (right or left)	●	●		
	OUTDOOR UNIT QUIET operation (manual)	—	—	Power selection	—	—		
	INTELLIGENT EYE operation	—	—	Low temperature cooling operation (-15°C) (5°F)	●	●		
	Quick warming function	—	●	°F/°C changeover R/C temperature display (factory setting: °F)	●	●		
	Hot-start function	—	●	Remote Control	5-rooms centralized controller (option)	●	●	
	Automatic defrosting	—	●		Remote control adaptor (normal open-pulse contact) (option)	●	●	
Operation	Automatic operation	—	●		Remote control adaptor (normal open contact) (option)	●	●	
	Program dry function	●	●	DIII-NET compatible (adaptor) (option)	●	●		
	Fan only	●	●	Remote Controller	Wireless	●	●	
	Lifestyle Convenience	New POWERFUL operation (non-inverter)	—		—	Wired (option)	●	●
		Inverter POWERFUL operation	●		●			
		Priority-room setting	—		—			
		COOL / HEAT mode lock	—		—			
		HOME LEAVE operation	—		—			
ECONO operation		●	●					
Indoor unit ON/OFF button		●	●					
Signal receiving sign		●	●					
R/C with back light	●	●						
Temperature display	—	—						

Note: ● : Available
 — : Not available

Part 2

Specifications

1. Specifications	7
1.1 Cooling Only	7
1.2 Heat Pump	11

1. Specifications

1.1 Cooling Only

60 Hz, 208 - 230 V

Model	Indoor Unit		FTKN09NMVJU		FTKN12NMVJU	
	Outdoor Unit		RKN09NMVJU		RKN12NMVJU	
Capacity Rated (Min. ~ Max.)	kW		2.64 (1.30 ~ 3.00)		3.52 (1.30 ~ 3.80)	
	Btu/h		9,000 (4,400 ~ 10,200)		12,000 (4,400 ~ 13,000)	
	kcal/h		2,270 (1,120 ~ 2,580)		3,030 (1,120 ~ 3,270)	
Moisture Removal	gal/h		0.32		0.45	
Running Current (Rated)	A		4.41 - 3.99		5.74 - 5.19	
Power Consumption Rated (Min. ~ Max.)	W		869 (278 ~ 1,135)		1,142 (260 ~ 1,250)	
Power Factor (Rated)	%		94.7 - 94.7		95.7 - 95.7	
COP Rated (Min. ~ Max.)	W/W		3.04 (4.68 ~ 2.64)		3.08 (5.00 ~ 3.04)	
EER Rated (Min. ~ Max.)	Btu/h-W		10.4 (15.8 ~ 9.0)		10.5 (16.9 ~ 10.4)	
SEER			15.0		15.0	
Piping Connections	Liquid	in. (mm)	φ 1/4 (φ 6.4)		φ 1/4 (φ 6.4)	
	Gas	in. (mm)	φ 3/8 (φ 9.5)		φ 3/8 (φ 9.5)	
	Drain	in. (mm)	φ 5/8 (φ 16.0)		φ 5/8 (φ 16.0)	
Heat Insulation			Both Liquid and Gas Pipes		Both Liquid and Gas Pipes	
Max. Interunit Piping Length	ft (m)		49-1/4 (15)		49-1/4 (15)	
Max. Interunit Height Difference	ft (m)		39-3/8 (12)		39-3/8 (12)	
Chargeless	ft (m)		32-13/16 (10)		32-13/16 (10)	
Amount of Additional Charge of Refrigerant	oz/ft (g/m)		0.21 (20)		0.21 (20)	
Indoor Unit			FTKN09NMVJU		FTKN12NMVJU	
Front Panel Color			White		White	
Airflow Rate	H	m ³ /min (cfm)	11.4 (403)		12.0 (424)	
	M		8.1 (286)		8.5 (300)	
	L		6.2 (219)		7.0 (247)	
	SL		4.1 (145)		4.0 (141)	
Fan	Type		Cross Flow Fan		Cross Flow Fan	
	Motor Output	W	18		22	
	Speed	Steps	5 Steps, Quiet, Auto		5 Steps, Quiet, Auto	
Air Direction Control			Right, Left, Horizontal, Downward		Right, Left, Horizontal, Downward	
Air Filter			Removable, Washable, Mildew Proof		Removable, Washable, Mildew Proof	
Running Current (Rated)	A		0.23 - 0.21		0.27 - 0.24	
Power Consumption (Rated)	W		25 - 25		29 - 29	
Power Factor (Rated)	%		52.3-51.8		51.6 - 52.5	
Temperature Control			Microcomputer Control		Microcomputer Control	
Dimensions (H x W x D)	in. (mm)		11-1/4 x 30-5/16 x 8-3/4 (285 x 770 x 223)		11-1/4 x 30-5/16 x 8-3/4 (285 x 770 x 223)	
Packaged Dimensions (H x W x D)	in. (mm)		12 x 32-11/16 x 14-3/16 (305 x 831 x 360)		12 x 32-11/16 x 14-3/16 (305 x 831 x 360)	
Weight	Lbs (kg)		18 (8)		18 (8)	
Gross Weight	Lbs (kg)		24 (11)		24 (11)	
Sound Pressure Level	H / M / L / SL	dB(A)	43 / 35 / 27 / 19		44 / 36 / 30 / 19	
Sound Power Level			—		—	
Outdoor Unit			RKN09NMVJU		RKN12NMVJU	
Casing Color			Ivory White		Ivory White	
Compressor	Type		Hermetically Sealed Swing Type		Hermetically Sealed Swing Type	
	Model		1YC23AUXD		1YC23AUXD	
Refrigerant Oil	Motor Output	W	790		790	
	Type		FVC50K		FVC50K	
Refrigerant	Charge	oz (L)	12.4 (0.375)		12.4 (0.375)	
	Type		R-410A		R-410A	
Airflow Rate	Charge	Lbs (kg)	1.54 (0.70)		2.09 (0.95)	
	H	m ³ /min (cfm)	35.2 (1,243)		35.0 (1,236)	
SL			—		—	
Fan	Type		Propeller		Propeller	
	Motor Output	W	20		26	
Running Current (Rated)	A		4.18 - 3.78		5.47 - 4.95	
Power Consumption (Rated)	W		844 - 844		1,113 - 1,113	
Power Factor (Rated)	%		97.1 - 97.1		97.8 - 97.8	
Starting Current	A		4.41		5.74	
Dimensions (H x W x D)	in. (mm)		21-5/8 x 26-9/16 x 11-3/16 (550 x 675 x 284)		21-5/8 x 26-9/16 x 11-3/16 (550 x 675 x 284)	
Packaged Dimensions (H x W x D)	in. (mm)		24-3/4 x 32-11/16 x 16 (629 x 830 x 407)		24-3/4 x 32-11/16 x 16 (629 x 830 x 407)	
Weight	Lbs (kg)		55 (25)		60 (27)	
Gross Weight	Lbs (kg)		66 (30)		71 (32)	
Sound Pressure Level	H	dB(A)	49		52	
Drawing No.			3D093121A		3D093123A	

Note: ■ The data are based on the conditions shown in the table below.

Cooling	Indoor ; 80°FDB (26.7°CDB) / 67°FWB (19.4°CWB) Outdoor ; 95°FDB (35°CDB) / 75°FWB (24°CWB)
Piping Length	25 ft (7.5 m)

Conversion Formulae
kcal/h = kW x 860
Btu/h = kW x 3412
cfm = m ³ /min x 35.3

60 Hz, 208 - 230 V

Model	Indoor Unit		FTKN18NMVJU		FTKN24NMVJU	
	Outdoor Unit		RKN18NMVJU		RKN24NMVJU	
Capacity Rated (Min. ~ Max.)	kW		5.02 (1.30 ~ 5.28)		6.45 (1.50 ~ 6.74)	
	Btu/h		17,100 (4,400 ~ 18,000)		22,000 (5,100 ~ 23,000)	
	kcal/h		4,320 (1,120 ~ 4,540)		5,550 (1,290 ~ 5,800)	
Moisture Removal	gal/h		1.0		1.2	
Running Current (Rated)	A		7.63 - 6.90		11.79 - 10.66	
Power Consumption Rated (Min. ~ Max.)	W		1,550 (240 ~ 1,680)		2,403 (295 ~ 2,550)	
Power Factor (Rated)	%		97.7 - 97.7		98.0 - 98.0	
COP Rated (Min. ~ Max.)	W/W		3.24 (5.42 ~ 3.14)		2.68 (5.08 ~ 2.64)	
EER Rated (Min. ~ Max.)	Btu/h-W		11.0 (18.3 ~ 10.7)		9.2 (17.3 ~ 9.0)	
SEER			15.0		15.0	
Piping Connections	Liquid	in. (mm)	φ 1/4 (φ 6.4)		φ 1/4 (φ 6.4)	
	Gas	in. (mm)	φ 1/2 (φ 12.7)		φ 5/8 (φ 15.9)	
	Drain	in. (mm)	φ 5/8 (φ 16.0)		φ 5/8 (φ 16.0)	
Heat Insulation			Both Liquid and Gas Pipes		Both Liquid and Gas Pipes	
Max. Interunit Piping Length	ft (m)		98-1/2 (30)		98-1/2 (30)	
Max. Interunit Height Difference	ft (m)		65-5/8 (20)		65-5/8 (20)	
Chargeless	ft (m)		32-13/16 (10)		32-13/16 (10)	
Amount of Additional Charge of Refrigerant	oz/ft (g/m)		0.21 (20)		0.21 (20)	
Indoor Unit			FTKN18NMVJU		FTKN24NMVJU	
Front Panel Color			White		White	
Airflow Rate	H	m ³ /min (cfm)	20.2 (713)		20.2 (713)	
	M		16.4 (579)		16.4 (579)	
	L		12.9 (455)		13.9 (491)	
	SL		11.8 (417)		11.8 (417)	
Fan	Type		Cross Flow Fan		Cross Flow Fan	
	Motor Output	W	46		46	
	Speed	Steps	5 Steps, Quiet, Auto		5 Steps, Quiet, Auto	
Air Direction Control			Right, Left, Horizontal, Downward		Right, Left, Horizontal, Downward	
Air Filter			Removable, Washable, Mildew Proof		Removable, Washable, Mildew Proof	
Running Current (Rated)	A		0.43 - 0.39		0.43 - 0.39	
Power Consumption (Rated)	W		58 - 58		58 - 58	
Power Factor (Rated)	%		64.8 - 64.7		64.8 - 64.7	
Temperature Control			Microcomputer Control		Microcomputer Control	
Dimensions (H x W x D)	in. (mm)		11-5/8 x 39 x 10-3/8 (295 x 990 x 263)		11-5/8 x 39 x 10-3/8 (295 x 990 x 263)	
Packaged Dimensions (H x W x D)	in. (mm)		14-9/16 x 42-1/2 x 15-3/8 (370 x 1,080 x 390)		14-9/16 x 42-1/2 x 15-3/8 (370 x 1,080 x 390)	
Weight	Lbs (kg)		27 (12)		27 (12)	
Gross Weight	Lbs (kg)		37 (17)		37 (17)	
Sound Pressure Level	H / M / L / SL	dB(A)	48 / 44 / 38 / 33		51 / 45 / 39 / 34	
Sound Power Level	dB		64		67	
Outdoor Unit			RKN18NMVJU		RKN24NMVJU	
Casing Color			Ivory White		Ivory White	
Compressor	Type		Hermetically Sealed Swing Type		Hermetically Sealed Swing Type	
	Model		1YC23AYXD		2YC36PXD	
	Motor Output	W	780		1,100	
Refrigerant Oil	Type		FVC50K		FVC50K	
	Charge	oz (L)	12.4 (0.375)		21.5 (0.650)	
Refrigerant	Type		R-410A		R-410A	
	Charge	Lbs (kg)	2.49 (1.13)		2.49 (1.13)	
Airflow Rate	H	m ³ /min (cfm)	65.5 (2,313)		73.9 (2,609)	
	SL		52.1 (1,840)		62.2 (2,196)	
Fan	Type		Propeller		Propeller	
	Motor Output	W	58		80	
Running Current (Rated)	A		7.20 - 6.51		11.36 - 10.27	
Power Consumption (Rated)	W		1,492 - 1,492		2,345 - 2,345	
Power Factor (Rated)	%		99.6 - 99.6		99.2 - 99.3	
Starting Current	A		7.63		11.79	
Dimensions (H x W x D)	in. (mm)		28-15/16 x 34-1/4 x 12-5/8 (735 x 870 x 320)		28-15/16 x 34-1/4 x 12-5/8 (735 x 870 x 320)	
Packaged Dimensions (H x W x D)	in. (mm)		31-7/8 x 41-9/16 x 17-1/2 (810 x 1,056 x 444)		31-7/8 x 41-9/16 x 17-1/2 (810 x 1,056 x 444)	
Weight	Lbs (kg)		90 (41)		97 (44)	
Gross Weight	Lbs (kg)		106 (48)		115 (52)	
Sound Pressure Level	H	dB(A)	56		59	
Drawing No.			3D091699A		3D091700A	

Note: ■ The data are based on the conditions shown in the table below.

Cooling	Indoor ; 80°FDB (26.7°CDB) / 67°FWB (19.4°CWB) Outdoor ; 95°FDB (35°CDB) / 75°FWB (24°CWB)
Piping Length	25 ft (7.5 m)

Conversion Formulae
kcal/h = kW x 860
Btu/h = kW x 3412
cfm = m ³ /min x 35.3

60 Hz, 208 - 230 V

Model	Indoor Unit		FTK09NMVJU		FTK12NMVJU	
	Outdoor Unit		RK09NMVJU		RK12NMVJU	
Capacity Rated (Min. ~ Max.)	kW		2.64 (1.30 ~ 3.00)		3.20 (1.30 ~ 3.90)	
	Btu/h		9,000 (4,400 ~ 10,200)		10,900 (4,400 ~ 13,300)	
	kcal/h		2,270 (1,120 ~ 2,580)		2,750 (1,120 ~ 3,350)	
Moisture Removal	gal/h		0.32		0.45	
Running Current (Rated)	A		3.77 - 3.41		4.42 - 3.99	
Power Consumption Rated (Min. ~ Max.)	W		721 (250 ~ 962)		874 (260 ~ 1,383)	
Power Factor (Rated)	%		91.9 - 91.9		95.1 - 95.2	
COP Rated (Min. ~ Max.)	W/W		3.66 (5.20 ~ 3.12)		3.66 (5.00 ~ 2.82)	
EER Rated (Min. ~ Max.)	Btu/h-W		12.5 (17.6 ~ 10.6)		12.5 (16.9 ~ 9.6)	
SEER			19.0		19.0	
Piping Connections	Liquid	in. (mm)	φ 1/4 (φ 6.4)		φ 1/4 (φ 6.4)	
	Gas	in. (mm)	φ 3/8 (φ 9.5)		φ 3/8 (φ 9.5)	
	Drain	in. (mm)	φ 5/8 (φ 16.0)		φ 5/8 (φ 16.0)	
Heat Insulation			Both Liquid and Gas Pipes		Both Liquid and Gas Pipes	
Max. Interunit Piping Length	ft (m)		65-5/8 (20)		65-5/8 (20)	
Max. Interunit Height Difference	ft (m)		49-1/4 (15)		49-1/4 (15)	
Chargeless	ft (m)		32-13/16 (10)		32-13/16 (10)	
Amount of Additional Charge of Refrigerant	oz/ft (g/m)		0.21 (20)		0.21 (20)	
Indoor Unit			FTK09NMVJU		FTK12NMVJU	
Front Panel Color			White		White	
Airflow Rate	H	m³/min (cfm)	11.8 (417)		12.3 (434)	
	M		8.4 (297)		8.8 (311)	
	L		6.9 (244)		7.0 (247)	
	SL		4.0 (141)		4.1 (145)	
Fan	Type	Cross Flow Fan		Cross Flow Fan		
	Motor Output	W	21		28	
	Speed	Steps	5 Steps, Quiet, Auto		5 Steps, Quiet, Auto	
Air Direction Control			Right, Left, Horizontal, Downward		Right, Left, Horizontal, Downward	
Air Filter			Removable, Washable, Mildew Proof		Removable, Washable, Mildew Proof	
Running Current (Rated)	A		0.25 - 0.23		0.28 - 0.25	
Power Consumption (Rated)	W		28 - 28		31 - 31	
Power Factor (Rated)	%		53.8 - 52.9		53.2 - 53.9	
Temperature Control			Microcomputer Control		Microcomputer Control	
Dimensions (H x W x D)	in. (mm)		11-1/4 x 30-5/16 x 8-3/4 (285 x 770 x 223)		11-1/4 x 30-5/16 x 8-3/4 (285 x 770 x 223)	
Packaged Dimensions (H x W x D)	in. (mm)		12 x 32-11/16 x 14-3/16 (305 x 831 x 360)		12 x 32-11/16 x 14-3/16 (305 x 831 x 360)	
Weight	Lbs (kg)		18 (8)		18 (8)	
Gross Weight	Lbs (kg)		24 (11)		25 (11)	
Sound Pressure Level	H / M / L / SL	dB(A)	43 / 36 / 30 / 19		45 / 37 / 30 / 19	
Outdoor Unit			RK09NMVJU		RK12NMVJU	
Casing Color			Ivory White		Ivory White	
Compressor	Type	Hermetically Sealed Swing Type		Hermetically Sealed Swing Type		
	Model	1YC23AUXD		1YC23AUXD		
	Motor Output	W	790		790	
Refrigerant Oil	Type	FVC50K		FVC50K		
	Charge	oz (L)	12.4 (0.375)		12.4 (0.375)	
Refrigerant	Type	R-410A		R-410A		
	Charge	Lbs (kg)	1.54 (0.70)		2.09 (0.95)	
Airflow Rate	H	m³/min (cfm)	31.2 (1,102)		31.3 (1,105)	
	SL		29.3 (1,035)		24.5 (865)	
Fan	Type	Propeller		Propeller		
	Motor Output	W	14		18	
Running Current (Rated)	A		3.52 - 3.18		4.14 - 3.74	
Power Consumption (Rated)	W		693 - 693		843 - 843	
Power Factor (Rated)	%		94.7 - 94.7		97.9 - 98.0	
Starting Current	A		3.77		—	
Dimensions (H x W x D)	in. (mm)		21-5/8 x 26-9/16 x 11-3/16 (550 x 675 x 284)		21-5/8 x 26-9/16 x 11-3/16 (550 x 675 x 284)	
Packaged Dimensions (H x W x D)	in. (mm)		24-3/4 x 32-11/16 x 16 (629 x 830 x 407)		24-3/4 x 32-11/16 x 16 (629 x 830 x 407)	
Weight	Lbs (kg)		55 (25)		60 (27)	
Gross Weight	Lbs (kg)		66 (30)		71 (32)	
Sound Pressure Level	H	dB(A)	46		49	
Drawing No.			C: 3D093560		C: 3D093561A	

Note: ■ The data are based on the conditions shown in the table below.

Cooling	Indoor ; 80°FDB (26.7°CDB) / 67°FWB (19.4°CWB) Outdoor ; 95°FDB (35°CDB) / 75°FWB (24°CWB)
Piping Length	25 ft (7.5 m)

Conversion Formulae
kcal/h = kW × 860
Btu/h = kW × 3412
cfm = m³/min × 35.3

60 Hz, 208 - 230 V

Model	Indoor Unit		FTK18NMVJU		FTK24NMVJU	
	Outdoor Unit		RK18NMVJU		RK24NMVJU	
Capacity Rated (Min. ~ Max.)	kW		5.28 (1.60 ~ 5.86)		6.20 (1.60 ~ 7.03)	
	Btu/h		18,000 (5,500 ~ 20,000)		21,200 (5,500 ~ 24,000)	
	kcal/h		4,540 (1,380 ~ 5,040)		5,330 (1,380 ~ 6,050)	
Moisture Removal	gal/h		1.0		1.2	
Running Current (Rated)	A		7.20 - 6.51		8.41 - 7.60	
Power Consumption Rated (Min. ~ Max.)	W		1,441 (295 ~ 1,745)		1,696 (290 ~ 2,255)	
Power Factor (Rated)	%		96.2 - 96.2		97.0 - 97.0	
COP Rated (Min. ~ Max.)	W/W		3.66 (5.42 ~ 3.36)		3.66 (5.52 ~ 3.12)	
EER Rated (Min. ~ Max.)	Btu/h-W		12.5 (18.6 ~ 11.5)		12.5 (19.0 ~ 10.6)	
SEER			18.0		18.0	
Piping Connections	Liquid	in. (mm)	φ 1/4 (φ 6.4)		φ 1/4 (φ 6.4)	
	Gas	in. (mm)	φ 1/2 (φ 12.7)		φ 5/8 (φ 15.9)	
	Drain	in. (mm)	φ 5/8 (φ 16.0)		φ 5/8 (φ 16.0)	
Heat Insulation			Both Liquid and Gas Pipes		Both Liquid and Gas Pipes	
Max. Interunit Piping Length	ft (m)		98-1/2 (30)		98-1/2 (30)	
Max. Interunit Height Difference	ft (m)		65-5/8 (20)		65-5/8 (20)	
Chargeless	ft (m)		32-13/16 (10)		32-13/16 (10)	
Amount of Additional Charge of Refrigerant	oz/ft (g/m)		0.21 (20)		0.21 (20)	
Indoor Unit			FTK18NMVJU		FTK24NMVJU	
Front Panel Color			White		White	
Airflow Rate	H	m³/min (cfm)	20.2 (713)		20.2 (713)	
	M		16.4 (579)		16.4 (579)	
	L		12.7 (448)		14.5 (512)	
	SL		11.4 (403)		11.4 (403)	
Fan	Type		Cross Flow Fan		Cross Flow Fan	
	Motor Output	W	46		46	
	Speed	Steps	5 Steps, Quiet, Auto		5 Steps, Quiet, Auto	
Air Direction Control			Right, Left, Horizontal, Downward		Right, Left, Horizontal, Downward	
Air Filter			Removable, Washable, Mildew Proof		Removable, Washable, Mildew Proof	
Running Current (Rated)	A		0.43 - 0.39		0.43 - 0.39	
Power Consumption (Rated)	W		58 - 58		58 - 58	
Power Factor (Rated)	%		64.8 - 64.7		64.8 - 64.7	
Temperature Control			Microcomputer Control		Microcomputer Control	
Dimensions (H x W x D)	in. (mm)		11-5/8 x 39 x 10-3/8 (295 x 990 x 263)		11-5/8 x 39 x 10-3/8 (295 x 990 x 263)	
Packaged Dimensions (H x W x D)	in. (mm)		14-9/16 x 42-1/2 x 15-3/8 (370 x 1,080 x 390)		14-9/16 x 42-1/2 x 15-3/8 (370 x 1,080 x 390)	
Weight	Lbs (kg)		27 (12)		27 (12)	
Gross Weight	Lbs (kg)		37 (17)		37 (17)	
Sound Pressure Level	H / M / L / SL	dB(A)	49 / 44 / 38 / 33		53 / 45 / 39 / 34	
Outdoor Unit			RK18NMVJU		RK24NMVJU	
Casing Color			Ivory White		Ivory White	
Compressor	Type		Hermetically Sealed Swing Type		Hermetically Sealed Swing Type	
	Model		2YC36PXD		2YC36PXD	
	Motor Output	W	1,100		1,100	
Refrigerant Oil	Type		FVC50K		FVC50K	
	Charge	oz (L)	21.5 (0.650)		21.5 (0.650)	
Refrigerant	Type		R-410A		R-410A	
	Charge	Lbs (kg)	2.49 (1.13)		3.20 (1.45)	
Airflow Rate	H	m³/min (cfm)	69.7 (2,461)		59.5 (2,101)	
	SL		59.7 (2,108)		49.9 (1,762)	
Fan	Type		Propeller		Propeller	
	Motor Output	W	69		58	
Running Current (Rated)	A		6.77 - 6.12		7.98 - 7.21	
Power Consumption (Rated)	W		1,383 - 1,383		1,638 - 1,638	
Power Factor (Rated)	%		98.2 - 98.3		98.7 - 98.8	
Starting Current	A		7.20		8.41	
Dimensions (H x W x D)	in. (mm)		28-15/16 x 34-1/4 x 12-5/8 (735 x 870 x 320)		28-15/16 x 34-1/4 x 12-5/8 (735 x 870 x 320)	
Packaged Dimensions (H x W x D)	in. (mm)		31-7/8 x 41-9/16 x 17-1/2 (810 x 1,056 x 444)		31-7/8 x 41-9/16 x 17-1/2 (810 x 1,056 x 444)	
Weight	Lbs (kg)		97 (44)		108 (49)	
Gross Weight	Lbs (kg)		115 (52)		126 (57)	
Sound Pressure Level	H	dB(A)	54		55	
Drawing No.			3D093564A		3D093565A	

Note: ■ The data are based on the conditions shown in the table below.

Cooling	Indoor ; 80°FDB (26.7°CDB) / 67°FWB (19.4°CWB) Outdoor ; 95°FDB (35°CDB) / 75°FWB (24°CWB)
Piping Length	25 ft (7.5 m)

Conversion Formulae
kcal/h = kW x 860
Btu/h = kW x 3412
cfm = m³/min x 35.3

1.2 Heat Pump

60 Hz, 208 - 230 V

Model	Indoor Unit		FTXN09NMVJU		FTXN12NMVJU	
	Outdoor Unit		RXN09NMVJU		RXN12NMVJU	
			Cooling	Heating	Cooling	Heating
Capacity Rated (Min. ~ Max.)	kW		2.64 (1.30 ~ 3.00)	2.64 (1.30 ~ 2.93)	3.52 (1.30 ~ 3.80)	3.52 (1.30 ~ 4.10)
	Btu/h		9,000 (4,400 ~ 10,200)	9,000 (4,400 ~ 10,000)	12,000 (4,400 ~ 13,000)	12,000 (4,400 ~ 14,000)
	kcal/h		2,270 (1,120 ~ 2,580)	2,270 (1,120 ~ 2,520)	3,030 (1,120 ~ 3,270)	3,030 (1,120 ~ 3,530)
Moisture Removal	gal/h		0.32	—	0.45	—
Running Current (Rated)	A		4.41 - 3.99	3.64 - 3.29	5.74 - 5.19	4.60 - 4.16
Power Consumption Rated (Min. ~ Max.)	W		869 (278 ~ 1,135)	680 (273 ~ 836)	1,142 (260 ~ 1,250)	911 (260 ~ 1,113)
Power Factor (Rated)	%		94.7 - 94.7	89.8 - 89.9	95.7 - 95.7	95.2 - 95.2
COP Rated (Min. ~ Max.)	W/W		3.04 (4.68 ~ 2.64)	3.88 (4.76 ~ 3.50)	3.08 (5.00 ~ 3.04)	3.86 (5.00 ~ 3.68)
EER Rated (Min. ~ Max.)	Btu/h-W		10.4 (15.8 ~ 9.0)	13.2 (16.1 ~ 12.0)	10.5 (16.9 ~ 10.4)	13.2 (16.9 ~ 12.6)
SEER / HSPF			15.0	8.2	15.0	8.2
Piping Connections	Liquid	in. (mm)	φ 1/4 (φ 6.4)		φ 1/4 (φ 6.4)	
	Gas	in. (mm)	φ 3/8 (φ 9.5)		φ 3/8 (φ 9.5)	
	Drain	in. (mm)	φ 5/8 (φ 16.0)		φ 5/8 (φ 16.0)	
Heat Insulation			Both Liquid and Gas Pipes		Both Liquid and Gas Pipes	
Max. Interunit Piping Length	ft (m)		49-1/4 (15)		49-1/4 (15)	
Max. Interunit Height Difference	ft (m)		39-3/8 (12)		39-3/8 (12)	
Chargeless	ft (m)		32-13/16 (10)		32-13/16 (10)	
Amount of Additional Charge of Refrigerant	oz/ft (g/m)		0.21 (20)		0.21 (20)	
Indoor Unit			FTXN09NMVJU		FTXN12NMVJU	
Front Panel Color			White		White	
Airflow Rate	H	m ³ /min (cfm)	11.4 (403)	11.5 (406)	12.0 (424)	11.7 (413)
	M		8.1 (286)	9.0 (318)	8.5 (300)	9.1 (321)
	L		6.2 (219)	7.0 (247)	7.0 (247)	7.0 (247)
	SL		4.1 (145)	6.1 (215)	4.0 (141)	6.0 (212)
Fan	Type	Cross Flow Fan		Cross Flow Fan		
	Motor Output	W		22		
	Speed	Steps		5 Steps, Quiet, Auto		
Air Direction Control			Right, Left, Horizontal, Downward		Right, Left, Horizontal, Downward	
Air Filter			Removable, Washable, Mildew Proof		Removable, Washable, Mildew Proof	
Running Current (Rated)	A		0.23 - 0.21	0.23 - 0.21	0.27 - 0.24	0.25 - 0.23
Power Consumption (Rated)	W		25 - 25	25 - 25	29 - 29	27 - 27
Power Factor (Rated)	%		52.3 - 51.8	52.3 - 51.8	51.6 - 52.5	51.9 - 51.0
Temperature Control			Microcomputer Control		Microcomputer Control	
Dimensions (H x W x D)	in. (mm)		11-1/4 x 30-5/16 x 8-3/4 (285 x 770 x 223)		11-1/4 x 30-5/16 x 8-3/4 (285 x 770 x 223)	
Packaged Dimensions (H x W x D)	in. (mm)		12 x 32-11/16 x 14-3/16 (305 x 831 x 360)		12 x 32-11/16 x 14-3/16 (305 x 831 x 360)	
Weight	Lbs (kg)		18 (8)		18 (8)	
Gross Weight	Lbs (kg)		24 (11)		24 (11)	
Sound Pressure Level	H / M / L / SL	dB(A)	43 / 35 / 27 / 19	43 / 35 / 28 / 25	44 / 36 / 30 / 19	44 / 36 / 29 / 26
Sound Power Level	dB		—		—	
Outdoor Unit			RXN09NMVJU		RXN12NMVJU	
Casing Color			Ivory White		Ivory White	
Compressor	Type	Hermetically Sealed Swing Type		Hermetically Sealed Swing Type		
	Model	1YC23AUXD		1YC23AUXD		
Refrigerant Oil	Motor Output	W		790		
	Type	FVC50K		FVC50K		
Refrigerant	Charge	oz (L)		12.4 (0.375)		
	Type	R-410A		R-410A		
Airflow Rate	H	m ³ /min (cfm)	35.2 (1,243)	31.6 (1,116)	35.0 (1,236)	34.7 (1,225)
	SL		—		—	
Fan	Type	Propeller		Propeller		
	Motor Output	W		26		
Running Current (Rated)	A		4.18 - 3.78	3.41 - 3.08	5.47 - 4.95	4.35 - 3.93
Power Consumption (Rated)	W		844 - 844	655 - 655	1,113 - 1,113	884 - 884
Power Factor (Rated)	%		97.1 - 97.1	92.3 - 92.5	97.8 - 97.8	97.7 - 97.8
Starting Current	A		4.41		5.74	
Dimensions (H x W x D)	in. (mm)		21-5/8 x 26-9/16 x 11-3/16 (550 x 675 x 284)		21-5/8 x 26-9/16 x 11-3/16 (550 x 675 x 284)	
Packaged Dimensions (H x W x D)	in. (mm)		24-3/4 x 32-11/16 x 16 (629 x 830 x 407)		24-3/4 x 32-11/16 x 16 (629 x 830 x 407)	
Weight	Lbs (kg)		55 (25)		60 (27)	
Gross Weight	Lbs (kg)		66 (30)		71 (32)	
Sound Pressure Level	H	dB(A)	49	49	52	52
Drawing No.			3D093120		3D093122	

Note: ■ The data are based on the conditions shown in the table below.

Cooling	Indoor ; 80°FDB (26.7°CDB) / 67°FWB (19.4°CWB) Outdoor ; 95°FDB (35°CDB) / 75°FWB (24°CWB)
Heating	Indoor ; 70°FDB (21°CDB) / 60°FWB (15.6°CWB) Outdoor ; 47°FDB (8.3°CDB) / 43°FWB (6°CWB)
Piping Length	25 ft (7.5 m)

Conversion Formulae
kcal/h = kW × 860
Btu/h = kW × 3412
cfm = m ³ /min × 35.3

60 Hz, 208 - 230V

Model	Indoor Unit		FTXN18NMVJU		FTXN24NMVJU	
	Outdoor Unit		RXN18NMVJU		RXN24NMVJU	
			Cooling	Heating	Cooling	Heating
Capacity Rated (Min. ~ Max.)	kW		5.02 (1.50 ~ 5.28)	5.28 (1.50 ~ 5.60)	6.45 (1.50 ~ 6.74)	6.45 (1.50 ~ 7.44)
	Btu/h		17,100 (5,100 ~ 18,000)	18,000 (5,100 ~ 19,100)	22,000 (5,100 ~ 23,000)	22,000 (5,100 ~ 25,400)
	kcal/h		4,320 (1,290 ~ 4,540)	4,540 (1,290 ~ 4,820)	5,550 (1,290 ~ 5,800)	5,550 (1,290 ~ 6,400)
Moisture Removal	gal/h		1.00	—	1.20	—
Running Current (Rated)	A		7.05 - 6.37	6.92 - 6.26	11.79 - 10.66	8.82 - 7.97
Power Consumption Rated (Min. ~ Max.)	W		1,401 (295 ~ 1,542)	1,381 (329 ~ 1,565)	2,403 (295 ~ 2,550)	1,790 (335 ~ 2,090)
Power Factor (Rated)	%		95.5 - 95.6	95.9 - 95.9	98.0 - 98.0	97.6 - 97.6
COP Rated (Min. ~ Max.)	W/W		3.58 (5.08 ~ 3.42)	3.82 (4.56 ~ 3.58)	2.68 (5.08 ~ 2.64)	3.60 (4.48 ~ 3.56)
EER Rated (Min. ~ Max.)	Btu/h·W		12.2 (17.3 ~ 11.7)	13.0 (15.5 ~ 12.2)	9.2 (17.3 ~ 9.0)	12.3 (15.2 ~ 12.2)
SEER / HSPF			15.0	8.2	15.0	8.2
Piping Connections	Liquid	in. (mm)	φ 1/4 (φ 6.4)		φ 1/4 (φ 6.4)	
	Gas	in. (mm)	φ 1/2 (φ 12.7)		φ 5/8 (φ 15.9)	
	Drain	in. (mm)	φ 5/8 (φ 16.0)		φ 5/8 (φ 16.0)	
Heat Insulation			Both Liquid and Gas Pipes		Both Liquid and Gas Pipes	
Max. Interunit Piping Length	ft (m)		98-1/2 (30)		98-1/2 (30)	
Max. Interunit Height Difference	ft (m)		65-5/8 (20)		65-5/8 (20)	
Chargeless	ft (m)		32-13/16 (10)		32-13/16 (10)	
Amount of Additional Charge of Refrigerant	oz/ft (g/m)		0.21 (20)		0.21 (20)	
Indoor Unit			FTXN18NMVJU		FTXN24NMVJU	
Front Panel Color			White		White	
Airflow Rate	H	m ³ /min (cfm)	20.2 (713)	18.7 (660)	20.2 (713)	21.1 (745)
	M		16.4 (579)	16.1 (568)	16.4 (579)	17.1 (604)
	L		12.9 (455)	13.3 (470)	13.9 (491)	13.3 (470)
	SL		11.8 (417)	11.9 (420)	11.8 (417)	11.9 (420)
Fan	Type	Cross Flow Fan		Cross Flow Fan		
	Motor Output	W		46		
	Speed	Steps		5 Steps, Quiet, Auto		
Air Direction Control			Right, Left, Horizontal, Downward		Right, Left, Horizontal, Downward	
Air Filter			Removable, Washable, Mildew Proof		Removable, Washable, Mildew Proof	
Running Current (Rated)	A		0.43 - 0.39	0.32 - 0.29	0.43 - 0.39	0.43 - 0.39
Power Consumption (Rated)	W		58 - 58	43 - 43	58 - 58	58 - 58
Power Factor (Rated)	%		64.8 - 64.7	64.6 - 64.5	64.8 - 64.7	64.8 - 64.7
Temperature Control			Microcomputer Control		Microcomputer Control	
Dimensions (H x W x D)	in. (mm)		11-5/8 x 39 x 10-3/8 (295 x 990 x 263)		11-5/8 x 39 x 10-3/8 (295 x 990 x 263)	
Packaged Dimensions (H x W x D)	in. (mm)		14-9/16 x 42-1/2 x 15-3/8 (370 x 1,080 x 390)		14-9/16 x 42-1/2 x 15-3/8 (370 x 1,080 x 390)	
Weight	Lbs (kg)		27 (12)		27 (12)	
Gross Weight	Lbs (kg)		37 (17)		37 (17)	
Sound Pressure Level	H / M / L / SL	dB(A)	48 / 44 / 38 / 33	48 / 42 / 37 / 33	51 / 45 / 39 / 34	51 / 43 / 37 / 34
Sound Power Level			64	64	67	67
Outdoor Unit			RXN18NMVJU		RXN24NMVJU	
Casing Color			Ivory White		Ivory White	
Compressor	Type	Hermetically Sealed Swing Type		Hermetically Sealed Swing Type		
	Model	2YC36PXD		2YC36PXD		
Refrigerant Oil	Motor Output	W		1,100		
	Type	FVC50K		FVC50K		
Refrigerant	Charge	oz (L)		21.5 (0.650)		
	Type	R-410A		R-410A		
Refrigerant	Charge	Lbs (kg)		2.49 (1.13)		
	Type	R-410A		R-410A		
Airflow Rate	H	m ³ /min (cfm)	65.5 (2,313)	55.2 (1,949)	73.9 (2,609)	66.5 (2,348)
	SL		52.1 (1,840)	46.9 (1,656)	62.2 (2,196)	56.0 (1,977)
Fan	Type	Propeller		Propeller		
	Motor Output	W		58		
Running Current (Rated)	A		6.62 - 5.98	6.60 - 5.97	11.36 - 10.27	8.39 - 7.58
Power Consumption (Rated)	W		1,343 - 1,343	1,338 - 1,338	2,345 - 2,345	1,732 - 1,732
Power Factor (Rated)	%		97.5 - 97.6	97.5 - 97.4	99.2 - 99.3	99.2 - 99.3
Starting Current	A		7.05		11.79	
Dimensions (H x W x D)	in. (mm)		28-15/16 x 34-1/4 x 12-5/8 (735 x 870 x 320)		28-15/16 x 34-1/4 x 12-5/8 (735 x 870 x 320)	
Packaged Dimensions (H x W x D)	in. (mm)		31-7/8 x 41-9/16 x 17-1/2 (810 x 1,056 x 444)		31-7/8 x 41-9/16 x 17-1/2 (810 x 1,056 x 444)	
Weight	Lbs (kg)		97 (44)		97 (44)	
Gross Weight	Lbs (kg)		115 (52)		115 (52)	
Sound Pressure Level	H	dB(A)	56	56	59	59
Drawing No.			3D091698		3D091697	

Note: ■ The data are based on the conditions shown in the table below.

Cooling	Indoor ; 80°FDB (26.7°CDB) / 67°FWB (19.4°CWB) Outdoor ; 95°FDB (35°CDB) / 75°FWB (24°CWB)
Heating	Indoor ; 70°FDB (21°CDB) Outdoor ; 47°FDB (8.3°CDB) / 43°FWB (6°CWB)
Piping Length	25 ft (7.5 m)

Conversion Formulae
kcal/h = kW x 860
Btu/h = kW x 3412
cfm = m ³ /min x 35.3

60 Hz, 208 - 230V

Model	Indoor Unit		FTX09NMVJU		FTX12NMVJU	
	Outdoor Unit		RX09NMVJU		RX12NMVJU	
			Cooling	Heating	Cooling	Heating
Capacity Rated (Min. ~ Max.)	kW		2.64 (1.30 ~ 3.00)	2.93 (1.30 ~ 3.80)	3.20 (1.30 ~ 3.90)	3.96 (1.30 ~ 4.80)
	Btu/h		9,000 (4,400 ~ 10,200)	10,000 (4,400 ~ 13,000)	10,900 (4,400 ~ 13,300)	13,500 (4,400 ~ 16,400)
	kcal/h		2,270 (1,120 ~ 2,580)	2,520 (1,120 ~ 3,270)	2,750 (1,120 ~ 3,350)	3,410 (1,120 ~ 4,130)
Moisture Removal	gal/h		0.32	—	0.45	—
Running Current (Rated)	A		3.77 - 3.41	3.76 - 3.40	4.42 - 3.99	5.24 - 4.73
Power Consumption Rated (Min. ~ Max.)	W		721 (250 ~ 962)	722 (260 ~ 1,100)	874 (260 ~ 1,383)	1,041 (260 ~ 1,350)
Power Factor (Rated)	%		91.9 - 91.9	92.3 - 92.3	95.1 - 95.2	95.5 - 95.7
COP Rated (Min. ~ Max.)	W/W		3.66 (5.20 ~ 3.12)	4.06 (5.00 ~ 3.42)	3.66 (5.00 ~ 2.82)	3.80 (5.00 ~ 3.56)
EER Rated (Min. ~ Max.)	Btu/h-W		12.5 (17.6 ~ 10.6)	13.9 (16.9 ~ 11.7)	12.5 (16.9 ~ 9.6)	13.0 (16.9 ~ 12.1)
SEER / HSPF			19.0	9.0	19.0	9.0
Piping Connections	Liquid	in. (mm)	φ 1/4 (φ 6.4)		φ 1/4 (φ 6.4)	
	Gas	in. (mm)	φ 3/8 (φ 9.5)		φ 3/8 (φ 9.5)	
	Drain	in. (mm)	φ 5/8 (φ 16.0)		φ 5/8 (φ 16.0)	
Heat Insulation			Both Liquid and Gas Pipes		Both Liquid and Gas Pipes	
Max. Interunit Piping Length	ft (m)		65-5/8 (20)		65-5/8 (20)	
Max. Interunit Height Difference	ft (m)		49-1/4 (15)		49-1/4 (15)	
Chargeless	ft (m)		32-13/16 (10)		32-13/16 (10)	
Amount of Additional Charge of Refrigerant	oz/ft (g/m)		0.21 (20)		0.21 (20)	
Indoor Unit			FTX09NMVJU		FTX12NMVJU	
Front Panel Color			White		White	
Airflow Rate	H	m ³ /min (cfm)	11.8 (417)	11.4 (403)	12.3 (434)	11.7 (413)
	M		8.4 (297)	9.3 (328)	8.8 (311)	9.1 (321)
	L		6.9 (244)	7.1 (251)	7.0 (247)	7.3 (258)
	SL		4.0 (141)	6.1 (215)	4.1 (145)	6.2 (219)
Fan	Type	Cross Flow Fan		Cross Flow Fan		
	Motor Output	W		21		
	Speed	Steps		5 Steps, Quiet, Auto		
Air Direction Control			Right, Left, Horizontal, Downward		Right, Left, Horizontal, Downward	
Air Filter			Removable, Washable, Mildew Proof		Removable, Washable, Mildew Proof	
Running Current (Rated)	A		0.25 - 0.23	0.23 - 0.21	0.28 - 0.25	0.25 - 0.23
Power Consumption (Rated)	W		28 - 28	25 - 25	31 - 31	28 - 28
Power Factor (Rated)	%		53.8 - 52.9	52.3 - 51.8	53.2 - 53.9	53.8 - 52.9
Temperature Control			Microcomputer Control		Microcomputer Control	
Dimensions (H x W x D)	in. (mm)		11-1/4 x 30-5/16 x 8-3/4 (285 x 770 x 223)		11-1/4 x 30-5/16 x 8-3/4 (285 x 770 x 223)	
Packaged Dimensions (H x W x D)	in. (mm)		12 x 32-11/16 x 14-3/16 (305 x 831 x 360)		12 x 32-11/16 x 14-3/16 (305 x 831 x 360)	
Weight	Lbs (kg)		18 (8)		18 (8)	
Gross Weight	Lbs (kg)		24 (11)		25 (11)	
Sound Pressure Level	H / M / L / SL	dB(A)	43 / 36 / 30 / 19	43 / 36 / 29 / 25	45 / 37 / 30 / 19	45 / 37 / 30 / 26
Outdoor Unit			RX09NMVJU		RX12NMVJU	
Casing Color			Ivory White		Ivory White	
Compressor	Type	Hermetically Sealed Swing Type		Hermetically Sealed Swing Type		
	Model	1YC23AUXD		1YC23AUXD		
Refrigerant Oil	Motor Output	W		790		
	Type	FVC50K		FVC50K		
Refrigerant	Charge	oz (L)		12.4 (0.375)		
	Type	R-410A		R-410A		
Airflow Rate	Charge	Lbs (kg)		2.09 (0.95)		
	H	m ³ /min (cfm)	31.2 (1,102)	28.5 (1,006)	31.3 (1,105)	26.1 (922)
SL	29.3 (1,035)		26.0 (918)	24.5 (865)	22.0 (777)	
Fan	Type	Propeller		Propeller		
	Motor Output	W		14		
Running Current (Rated)	A		3.52 - 3.18	3.53 - 3.19	4.14 - 3.74	4.99 - 4.50
Power Consumption (Rated)	W		693 - 693	697 - 697	843 - 843	1,013 - 1,013
Power Factor (Rated)	%		94.7 - 94.7	94.9 - 95.0	97.9 - 98.0	97.6 - 97.9
Starting Current	A		3.77		5.24	
Dimensions (H x W x D)	in. (mm)		21-5/8 x 26-9/16 x 11-3/16 (550 x 675 x 284)		21-5/8 x 26-9/16 x 11-3/16 (550 x 675 x 284)	
Packaged Dimensions (H x W x D)	in. (mm)		24-3/4 x 32-11/16 x 16 (629 x 830 x 407)		24-3/4 x 32-11/16 x 16 (629 x 830 x 407)	
Weight	Lbs (kg)		55 (25)		60 (27)	
Gross Weight	Lbs (kg)		66 (30)		71 (32)	
Sound Pressure Level	H	dB(A)	46	48	49	49
Drawing No.			C: 3D093558		C: 3D093559A	

Note: ■ The data are based on the conditions shown in the table below.

Cooling	Indoor ; 80°FDB (26.7°CDB) / 67°FWB (19.4°CWB) Outdoor ; 95°FDB (35°CDB) / 75°FWB (24°CWB)
Heating	Indoor ; 70°FDB (21°CDB) / 60°FWB (15.6°CWB) Outdoor ; 47°FDB (8.3°CDB) / 43°FWB (6°CWB)
Piping Length	25 ft (7.5 m)

Conversion Formulae
kcal/h = kW x 860
Btu/h = kW x 3412
cfm = m ³ /min x 35.3

60 Hz, 208 - 230V

Model	Indoor Unit		FTX18NMVJU		FTX24NMVJU	
	Outdoor Unit		RX18NMVJU		RX24NMVJU	
			Cooling	Heating	Cooling	Heating
Capacity Rated (Min. ~ Max.)	kW		5.28 (1.60 ~ 5.86)	6.33 (1.60 ~ 7.03)	6.20 (1.60 ~ 7.03)	7.03 (1.70 ~ 8.10)
	Btu/h		18,000 (5,500 ~ 20,000)	21,600 (5,500 ~ 24,000)	21,200 (5,500 ~ 24,000)	24,000 (5,800 ~ 27,600)
	kcal/h		4,540 (1,380 ~ 5,040)	5,440 (1,380 ~ 6,050)	5,330 (1,380 ~ 6,050)	6,050 (1,460 ~ 6,970)
Moisture Removal	gal/h		1.00	—	1.20	—
Running Current (Rated)	A		7.20 - 6.51	8.68 - 7.85	8.41 - 7.60	9.90 - 8.95
Power Consumption Rated (Min. ~ Max.)	W		1,441 (295 ~ 1,745)	1,758 (348 ~ 2,000)	1,696 (290 ~ 2,255)	2,010 (381 ~ 2,380)
Power Factor (Rated)	%		96.2 - 96.2	97.4 - 97.4	97.0 - 97.0	97.6 - 97.6
COP Rated (Min. ~ Max.)	W/W		3.66 (5.42 ~ 3.36)	3.60 (4.60 ~ 3.52)	3.66 (5.52 ~ 3.12)	3.50 (4.46 ~ 3.40)
EER Rated (Min. ~ Max.)	Btu/h-W		12.5 (18.6 ~ 11.5)	12.3 (15.8 ~ 12.0)	12.5 (19.0 ~ 10.6)	11.9 (15.2 ~ 11.6)
SEER / HSPF			18.0	9.0	18.0	9.0
Piping Connections	Liquid	in. (mm)	φ 1/4 (φ 6.4)		φ 1/4 (φ 6.4)	
	Gas	in. (mm)	φ 1/2 (φ 12.7)		φ 5/8 (φ 15.9)	
	Drain	in. (mm)	φ 5/8 (φ 16.0)		φ 5/8 (φ 16.0)	
Heat Insulation			Both Liquid and Gas Pipes		Both Liquid and Gas Pipes	
Max. Interunit Piping Length	ft (m)		98-1/2 (30)		98-1/2 (30)	
Max. Interunit Height Difference	ft (m)		65-5/8 (20)		65-5/8 (20)	
Chargeless	ft (m)		32-13/16 (10)		32-13/16 (10)	
Amount of Additional Charge of Refrigerant	oz/ft (g/m)		0.21 (20)		0.21 (20)	
Indoor Unit			FTX18NMVJU		FTX24NMVJU	
Front Panel Color			White		White	
Airflow Rate	H	m ³ /min (cfm)	20.2 (713)	21.1 (745)	20.2 (713)	21.1 (745)
	M		16.4 (579)	17.1 (604)	16.4 (579)	17.1 (604)
	L		12.7 (448)	13.3 (470)	14.5 (512)	13.3 (470)
	SL		11.4 (403)	11.9 (420)	11.4 (403)	11.9 (420)
Fan	Type		Cross Flow Fan		Cross Flow Fan	
	Motor Output	W	46		46	
	Speed	Steps	5 Steps, Quiet, Auto		5 Steps, Quiet, Auto	
Air Direction Control			Right, Left, Horizontal, Downward		Right, Left, Horizontal, Downward	
Air Filter			Removable, Washable, Mildew Proof		Removable, Washable, Mildew Proof	
Running Current (Rated)	A		0.43 - 0.39	0.43 - 0.39	0.43 - 0.39	0.43 - 0.39
Power Consumption (Rated)	W		58 - 58	58 - 58	58 - 58	58 - 58
Power Factor (Rated)	%		64.8 - 64.7	64.8 - 64.7	64.8 - 64.7	64.8 - 64.7
Temperature Control			Microcomputer Control		Microcomputer Control	
Dimensions (H x W x D)	in. (mm)		11-5/8 x 39 x 10-3/8 (295 x 990 x 263)		11-5/8 x 39 x 10-3/8 (295 x 990 x 263)	
Packaged Dimensions (H x W x D)	in. (mm)		14-9/16 x 42-1/2 x 15-3/8 (370 x 1,080 x 390)		14-9/16 x 42-1/2 x 15-3/8 (370 x 1,080 x 390)	
Weight	Lbs (kg)		27 (12)		27 (12)	
Gross Weight	Lbs (kg)		37 (17)		37 (17)	
Sound Pressure Level	H / M / L / SL	dB(A)	49 / 44 / 38 / 33	49 / 42 / 37 / 33	53 / 45 / 39 / 34	53 / 43 / 37 / 34
Outdoor Unit			RX18NMVJU		RX24NMVJU	
Casing Color			Ivory White		Ivory White	
Compressor	Type		Hermetically Sealed Swing Type		Hermetically Sealed Swing Type	
	Model		2YC36PXD		2YC36PXD	
	Motor Output	W	1,100		1,100	
Refrigerant Oil	Type		FVC50K		FVC50K	
	Charge	oz (L)	21.5 (0.650)		21.5 (0.650)	
Refrigerant	Type		R-410A		R-410A	
	Charge	Lbs (kg)	2.49 (1.13)		3.20 (1.45)	
Airflow Rate	H	m ³ /min (cfm)	69.7 (2,461)	62.8 (2,217)	59.5 (2,101)	53.6 (1,893)
	SL		59.7 (2,108)	53.7 (1,896)	49.9 (1,762)	44.9 (1,585)
Fan	Type		Propeller		Propeller	
	Motor Output	W	69		58	
Running Current (Rated)	A		6.77 - 6.12	8.25 - 7.46	7.98 - 7.21	9.47 - 8.56
Power Consumption (Rated)	W		1,383 - 1,383	1,700 - 1,700	1,638 - 1,638	1,952 - 1,952
Power Factor (Rated)	%		98.2 - 98.3	99.1 - 99.1	98.7 - 98.8	99.1 - 99.1
Starting Current	A		8.68		9.90	
Dimensions (H x W x D)	in. (mm)		28-15/16 x 34-1/4 x 12-5/8 (735 x 870 x 320)		28-15/16 x 34-1/4 x 12-5/8 (735 x 870 x 320)	
Packaged Dimensions (H x W x D)	in. (mm)		31-7/8 x 41-9/16 x 17-1/2 (810 x 1,056 x 444)		31-7/8 x 41-9/16 x 17-1/2 (810 x 1,056 x 444)	
Weight	Lbs (kg)		97 (44)		108 (49)	
Gross Weight	Lbs (kg)		115 (52)		126 (57)	
Sound Pressure Level	H	dB(A)	54	54	55	55
Drawing No.			3D093562		3D093563A	

Note: ■ The data are based on the conditions shown in the table below.

Cooling	Indoor ; 80°FDB (26.7°CDB) / 67°FWB (19.4°CWB) Outdoor ; 95°FDB (35°CDB) / 75°FWB (24°CWB)
Heating	Indoor ; 70°FDB (21°CDB) / 60°FWB (15.6°CWB) Outdoor ; 47°FDB (8.3°CDB) / 43°FWB (6°CWB)
Piping Length	25 ft (7.5 m)

Conversion Formulae
kcal/h = kW x 860
Btu/h = kW x 3412
cfm = m ³ /min x 35.3

Part 3

Printed Circuit Board

Connector Wiring Diagram

1. Indoor Unit.....	16
1.1 09/12 Class	16
1.2 18/24 Class	18
2. Outdoor Unit.....	20
2.1 09/12 Class, RKN18NMVJU	20
2.2 RXN18NMVJU, RK(X)18NMVJU, 24 class	21

1. Indoor Unit

1.1 09/12 Class

Control PCB (PCB1)

- 1) S6 Connector for swing motor (horizontal blade)
- 2) S26 Connector for display PCB
- 3) S32 Connector for indoor heat exchanger thermistor
- 4) S200 Connector for DC fan motor
- 5) H1, H2, H3, FG Connector for terminal board
- 6) FU1 Fuse (3.15 A, 250 V)
- 7) V2 Varistor

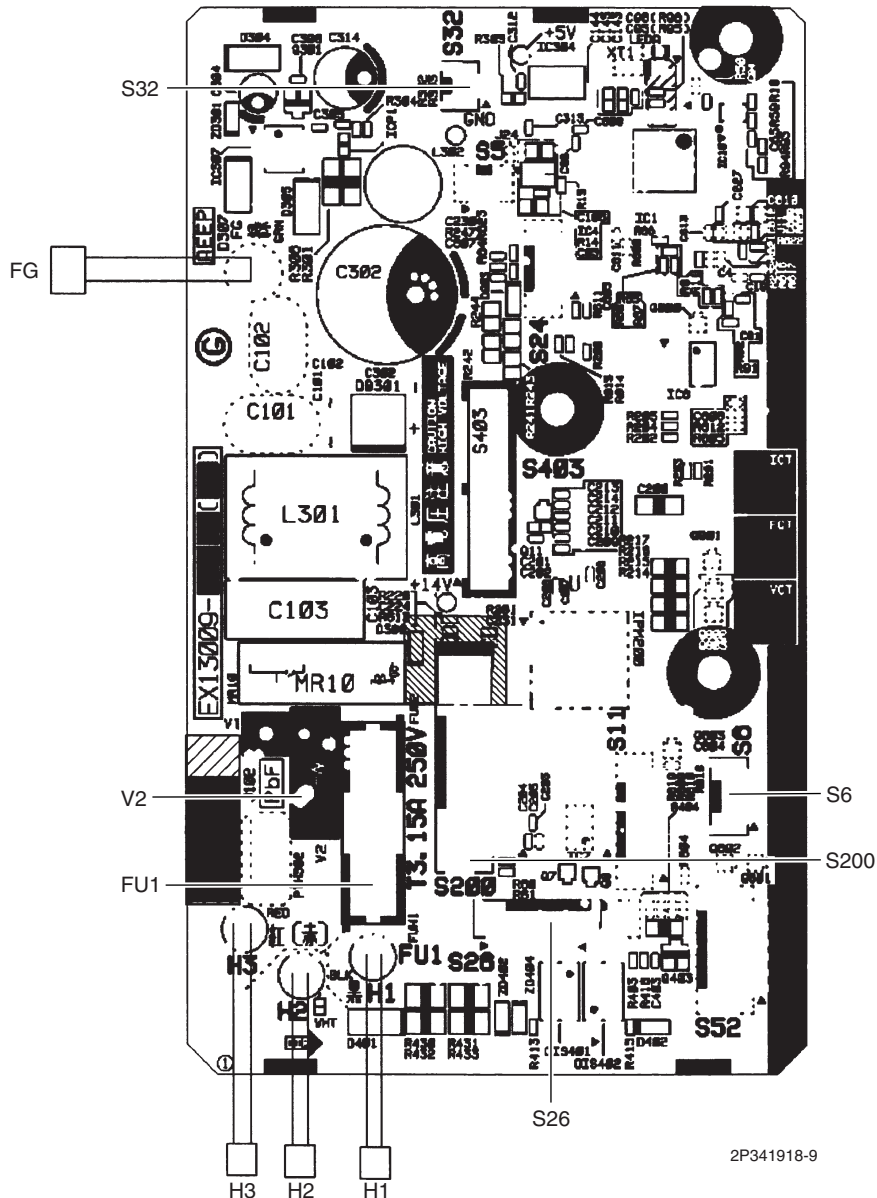

**Display PCB
(PCB2)**

- | | |
|---|---|
| <ul style="list-style-type: none"> 1) S27 2) SW1 (S1W) 3) LED1 (H1P) 4) LED2 (H2P) 5) RTH1 (R1T) | <p>Connector for control PCB</p> <p>Forced cooling operation ON/OFF button
* Refer to page 103 for detail.</p> <p>LED for operation (green)</p> <p>LED for timer (yellow)</p> <p>Room temperature thermistor</p> |
|---|---|

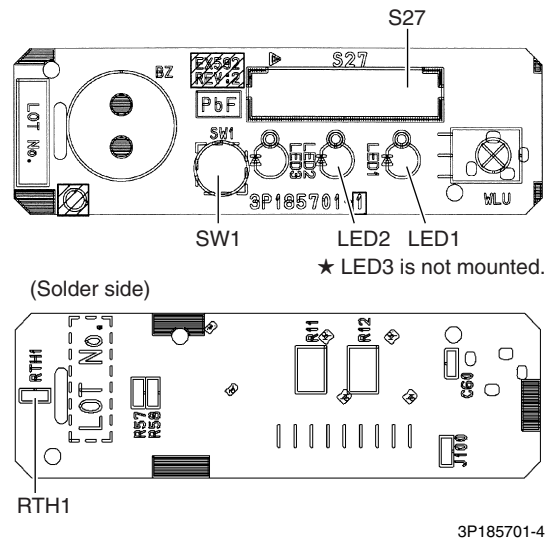

i Note: The symbols in the parenthesis are the names on the appropriate wiring diagram.

1.2 18/24 Class

Control PCB (PCB2)

- 1) S6 Connector for swing motor (horizontal blade)
- 2) S26 Connector for display PCB
- 3) S32 Connector for indoor heat exchanger thermistor
- 4) S200 Connector for DC fan motor
- 5) S900 Connector for filter PCB

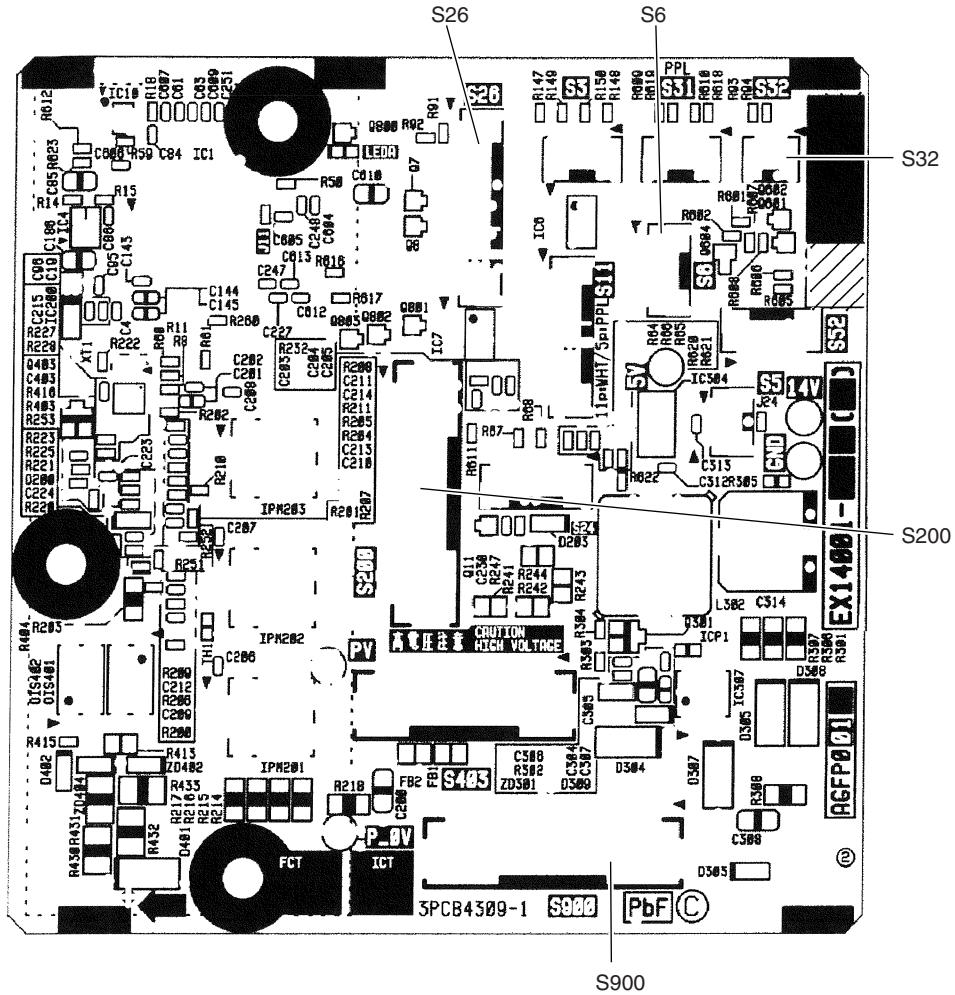

3P380931-1

**Filter PCB
(PCB1)**

- 1) S100 Connector for terminal board
- 2) S800 Connector for control PCB
- 3) FG, HE Connector for ground
- 4) FU1 Fuse (3.15 A, 250 V)
- 5) V2 Varistor

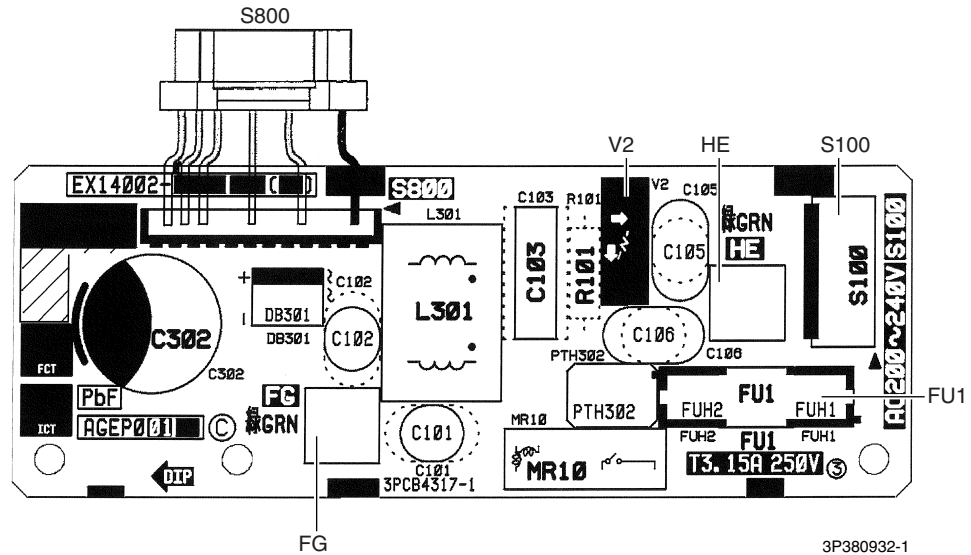

**Display PCB
(PCB3)**

- 1) S27 Connector for control PCB
- 2) SW1 (S1W) Forced cooling operation **ON/OFF** button
* Refer to page 103 for detail.
- 3) LED1 (H1P) LED for operation (green)
- 4) LED2 (H2P) LED for timer (yellow)
- 5) RTH1 (R1T) Room temperature thermistor

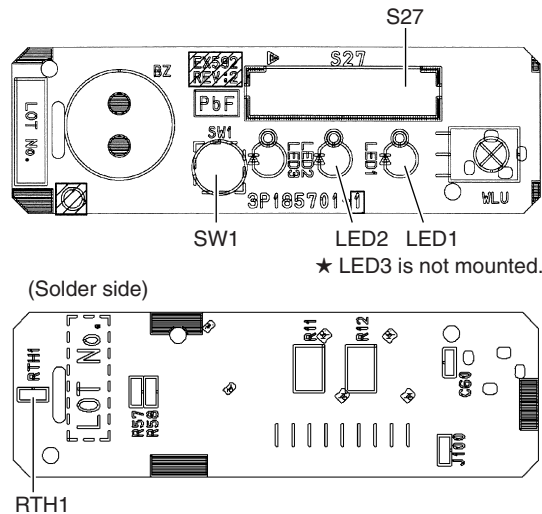

Note: The symbols in the parenthesis are the names on the appropriate wiring diagram.

2. Outdoor Unit

2.1 09/12 Class, RKN18NMVJU

Main PCB

- | | |
|-----------------|--|
| 1) S20 | Connector for electronic expansion valve coil |
| 2) S30 | Connector for compressor |
| 3) S40 | Connector for overload protector |
| 4) S71 | Connector for DC fan motor |
| 5) S80 | Connector for four way valve coil (heat pump model only) |
| 6) S90 | Connector for thermistors
(outdoor temperature, outdoor heat exchanger, discharge pipe) |
| 7) HL1, HN1, S | Connector for terminal board |
| 8) E1, E2 | Terminal for ground wire |
| 9) HR1, HR2 | Connector for reactor |
| 10)FU1, FU2 | Fuse (3.15 A, 250 V) |
| 11)FU3 | Fuse (20 A, 250 V) |
| 12)J6 | Jumper for facility setting (RK(X)-N models only)
* Refer to page 107 for detail. |
| 12)LED A | LED for service monitor (green) |
| 13)V2, V3, V150 | Varistor |

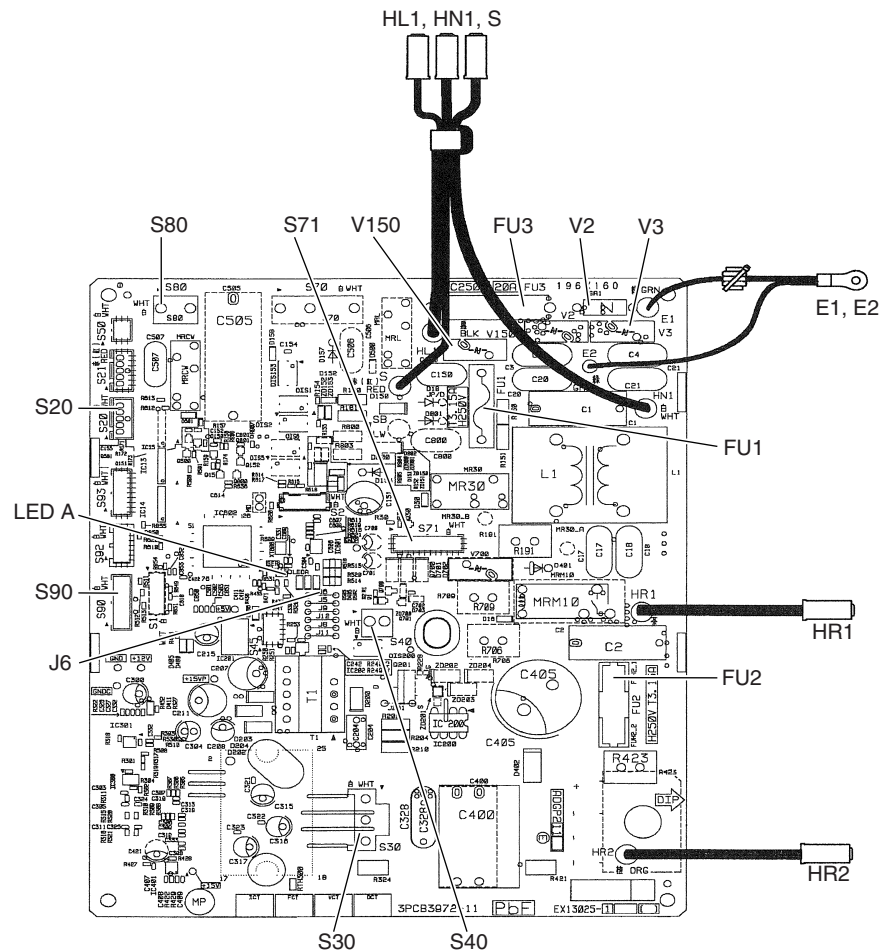

2P353825-7
2P353825-8



Caution **Replace the PCB if you accidentally cut a wrong jumper.**

Jumpers are necessary for electronic circuit. Improper operation may occur if you cut any of them.

2.2 RXN18NMVJU, RK(X)18NMVJU, 24 class

Main PCB

- | | |
|----------------|--|
| 1) S20 | Connector for electronic expansion valve coil |
| 2) S40 | Connector for overload protector |
| 3) S70 | Connector for DC fan motor |
| 4) S80 | Connector for four way valve coil (heat pump model only) |
| 5) S90 | Connector for thermistors
(outdoor temperature, outdoor heat exchanger, discharge pipe) |
| 6) HL1, HN1, S | Connector for terminal board |
| 7) E1, E2 | Terminal for ground |
| 8) U, V, W | Connector for compressor |
| 9) FU1, FU2 | Fuse (3.15 A, 250 V) |
| 10) FU3 | Fuse (30 A, 250 V) |
| 11) J6 | Jumper for facility setting (RK(X)-N models only)
* Refer to page 107 for detail. |
| 12) LED A | LED for service monitor (green) |
| 13) V1, V2, V3 | Varistor |

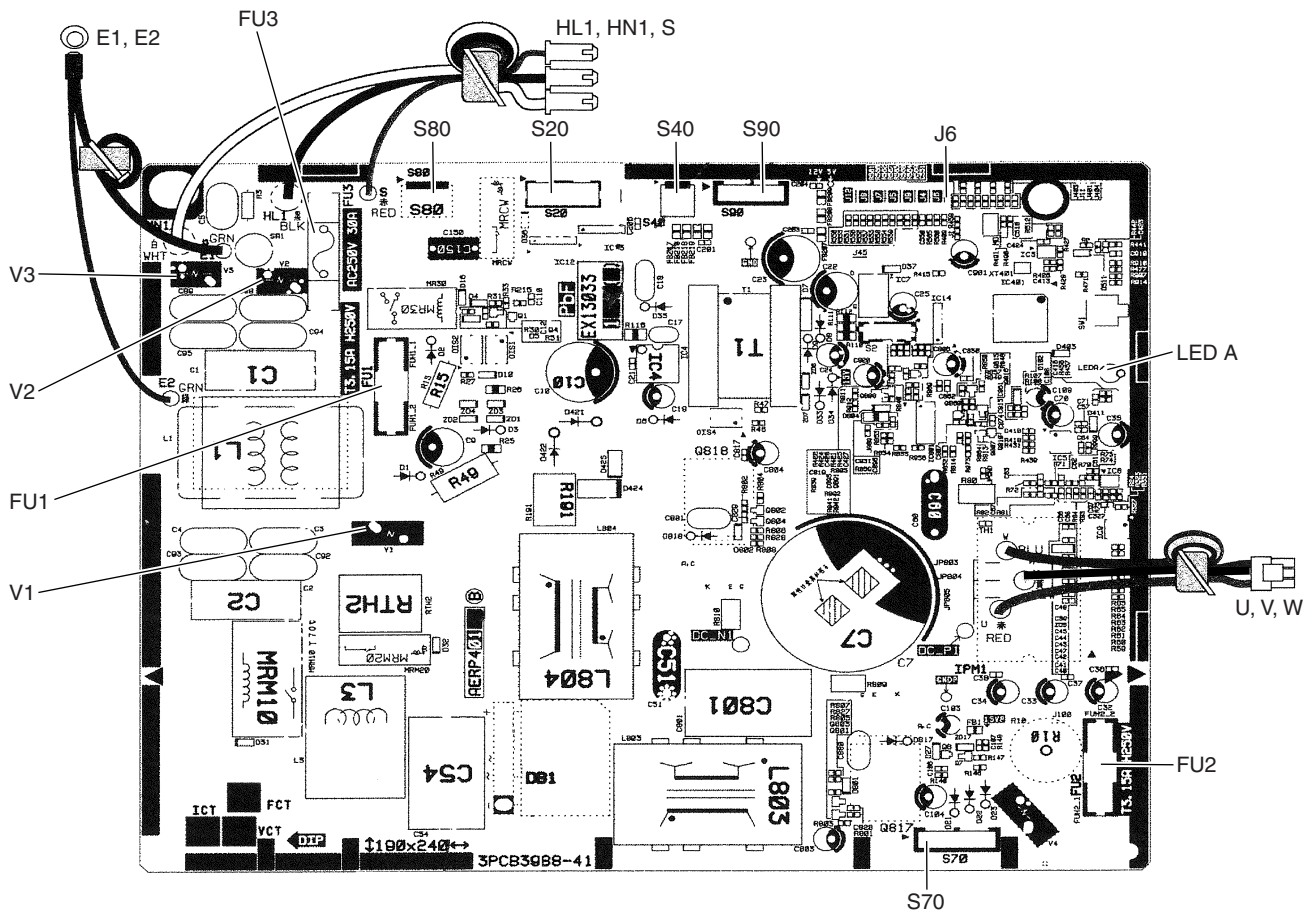

2P382390-6



Caution

Replace the PCB if you accidentally cut a wrong jumper.

Jumpers are necessary for electronic circuit. Improper operation may occur if you cut any of them.

Part 4

Function and Control

1. Main Functions.....	23
1.1 Temperature Control	23
1.2 Frequency Principle.....	23
1.3 Airflow Direction Control.....	25
1.4 Fan Speed Control for Indoor Unit	26
1.5 Program Dry Operation	27
1.6 Automatic Operation.....	28
1.7 Thermostat Control.....	29
1.8 NIGHT SET Mode	30
1.9 ECONO Operation	30
1.10 Inverter POWERFUL Operation	31
1.11 Other Functions.....	32
2. Function of Thermistor	33
3. Control Specification	34
3.1 Mode Hierarchy	34
3.2 Frequency Control.....	35
3.3 Controls at Mode Changing / Start-up.....	37
3.4 Discharge Pipe Temperature Control.....	39
3.5 Input Current Control.....	40
3.6 Freeze-up Protection Control	41
3.7 Heating Peak-cut Control	41
3.8 Outdoor Fan Control.....	42
3.9 Liquid Compression Protection Function.....	42
3.10 Defrost Control	43
3.11 Electronic Expansion Valve Control	44
3.12 Malfunctions	47

1. Main Functions

1.1 Temperature Control

Definitions of Temperatures

The definitions of temperatures are classified as following.

- ◆ Room temperature: temperature of lower part of the room
- ◆ Set temperature: temperature set by remote controller
- ◆ Room thermistor temperature: temperature detected by room temperature thermistor
- ◆ Target temperature: temperature determined by microcomputer

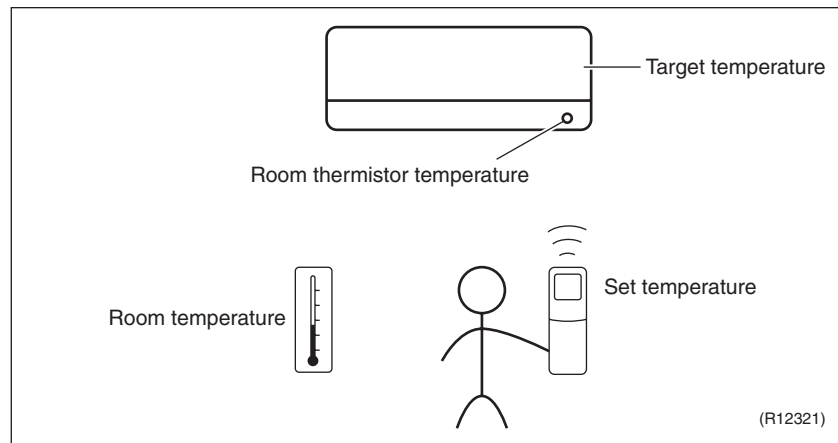

Temperature Control

The temperature of the room is detected by the room temperature thermistor. However, there is a difference between the temperature detected by room temperature thermistor and the temperature of lower part of the room, depending on the type of the indoor unit or installation condition. Practically, the temperature control is done by the target temperature appropriately adjusted for the indoor unit and the temperature detected by room temperature thermistor.

1.2 Frequency Principle

Control Parameters

The frequency of the compressor is controlled by the following 2 parameters:

- The load condition of the operating indoor unit
- The difference between the room thermistor temperature and the target temperature

The target frequency is adapted by additional parameters in the following cases:

- Frequency restrictions
- Initial settings
- Forced cooling operation

Inverter Principle

To regulate the capacity, a frequency control is needed. The inverter makes it possible to control the rotation speed of the compressor. The following table explains the inverter principle:

Phase	Description
1	The supplied AC power source is converted into the DC power source for the present.
2	The DC power source is reconverted into the three phase AC power source with variable frequency. <ul style="list-style-type: none"> ■ When the frequency increases, the rotation speed of the compressor increases resulting in an increase of refrigerant circulation. This leads to a larger amount of heat exchange per unit. ■ When the frequency decreases, the rotation speed of the compressor decreases resulting in a decrease of refrigerant circulation. This leads to a smaller amount of heat exchange per unit.

The following drawing shows a schematic view of the inverter principle:

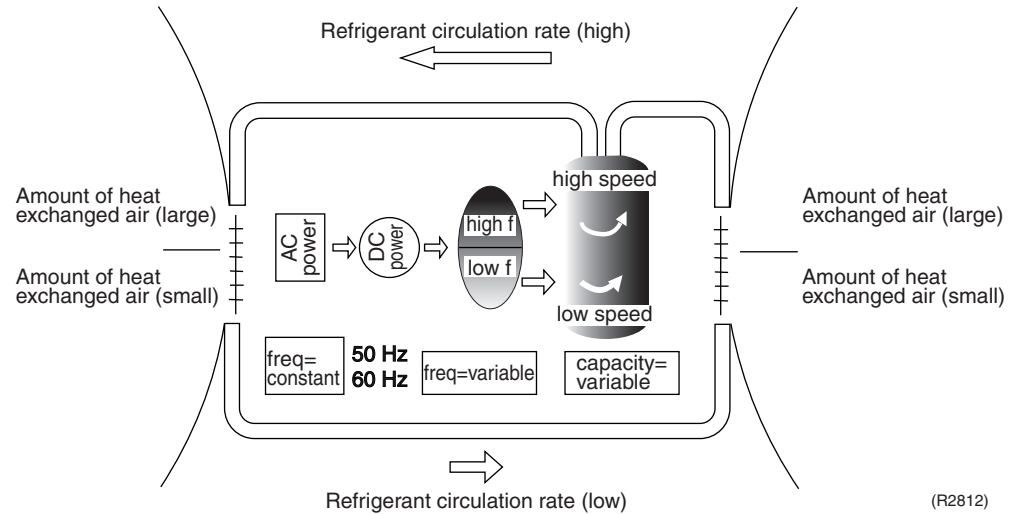

Inverter Features

The inverter provides the following features:

- The regulating capacity can be changed according to the changes in the outdoor temperature and cooling / heating load.
- Quick heating and quick cooling
The rotation speed of the compressor is increased when starting the heating (or cooling). This enables to reach the set temperature quickly.
- Even during extreme cold weather, high capacity is achieved. It is maintained even when the outdoor temperature is 2°C (35.6 °F).
- Comfortable air conditioning
A fine adjustment is integrated to keep the room temperature constant.
- Energy saving heating and cooling
Once the set temperature is reached, the energy saving operation enables to maintain the room temperature at low power.

Frequency Limits

The following functions regulate the minimum and maximum frequency:

Frequency	Functions
Low	<ul style="list-style-type: none"> ■ Four way valve operation compensation. Refer to page 38.
High	<ul style="list-style-type: none"> ■ Compressor protection function. Refer to page 38. ■ Discharge pipe temperature control. Refer to page 39. ■ Input current control. Refer to page 40. ■ Freeze-up protection control. Refer to page 41. ■ Heating peak-cut control. Refer to page 41. ■ Defrost control. Refer to page 43.

Forced Cooling Operation

Refer to page 103 for detail.

1.3 Airflow Direction Control

Power-Airflow Flap

The large flap sends a large volume of air downward to the floor and provides an optimum control in cooling, dry, and heating operation.

<Cooling / Dry>

During cooling or dry operation, the flap retracts into the indoor unit. Then, cool air can be blown far and distributed all over the room.

<Heating>

During heating operation, the large flap directs airflow downward to spread the warm air to the entire room.

Wide-Angle Louvers

The louvers, made of elastic synthetic resin, provide a wide range of airflow that guarantees comfortable air distribution.

Auto-Swing

The following table explains the auto-swing process for cooling, dry, heating, and fan:

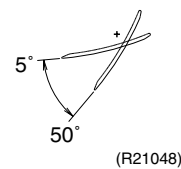
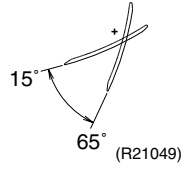
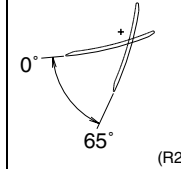
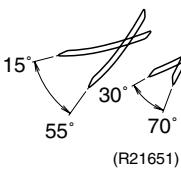
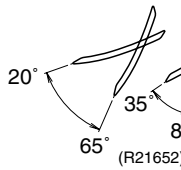
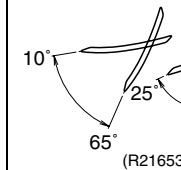
	Flap (up and down)		
	Cooling / Dry	Heating	Fan
09/12 class			
18/24 class			

COMFORT AIRFLOW Operation

The flap is controlled not to blow the air directly at the people in the room.

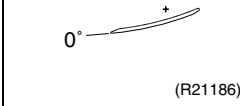
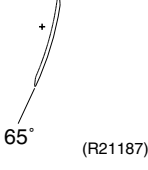
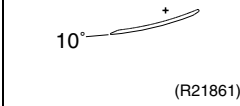
	Cooling	Heating
09/12 class		
18/24 class		



1.4 Fan Speed Control for Indoor Unit

Outline

Phase control and fan speed control contains 9 steps: LLL, LL, SL, L, ML, M, MH, H, and HH. The airflow rate can be automatically controlled depending on the difference between the room thermistor temperature and the target temperature.

Automatic Fan Speed Control

In automatic fan speed operation, the step SL is not available.

Step	Cooling	Heating
LLL	 (R11681)	 (R6834)
LL		
L		
ML		
M		
MH		
H		
HH (POWERFUL)		

 = The airflow rate is automatically controlled within this range when the **FAN** button is set to automatic.

<Cooling>

The following drawing explains the principle of fan speed control for cooling.

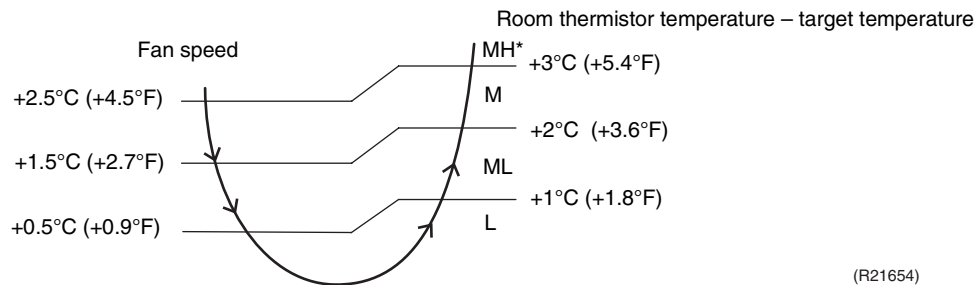

*The upper limit is M tap in 30 minutes from the operation start.

<Heating>

In heating operation, the fan speed is regulated according to the indoor heat exchanger temperature and the difference between the room thermistor temperature and the target temperature.



Note: The fan stops during defrost control.

COMFORT AIRFLOW Operation

- The fan speed is controlled automatically within the following steps.
 - <Cooling>
L tap ~ MH tap (same as automatic)
 - <Heating>
L tap ~ M tap
- The latest command has the priority between POWERFUL and COMFORT AIRFLOW.

1.5 Program Dry Operation

Outline Program dry operation removes humidity while preventing the room temperature from lowering. Since the microcomputer controls both the temperature and airflow rate, the temperature adjustment and **FAN** setting buttons are inoperable.

Detail The microcomputer automatically sets the temperature and airflow rate. The difference between the room thermistor temperature at start-up and the target temperature is divided into two zones. Then, the unit operates in an appropriate capacity for each zone to maintain the temperature and humidity at a comfortable level.

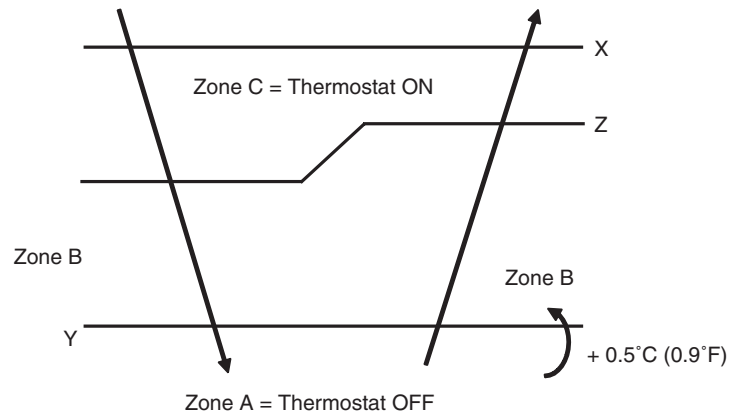

(R11587)

Room thermistor temperature at start-up	Target temperature X	Thermostat OFF point Y	Thermostat ON point Z ★
24°C or more (75.2°F or more)	Room thermistor temperature at start-up	X - 2.5°C (X - 4.5°F)	X - 0.5°C (X - 0.9°F)
18 ~ 23.5°C (64.4 ~ 74.3°F)		X - 2.0°C (X - 3.6°F)	X - 0.5°C (X - 0.9°F)
17.5°C or less (63.5°F or less)	18°C (64.4°F)	X - 2.0°C (X - 3.6°F)	X - 0.5°C = 17.5°C (X - 0.9°F = 63.5°F)

★ Thermostat turns on also when the room temperature is in the zone B for 10 min.

1.6 Automatic Operation

Outline

Automatic Cooling / Heating Function

When the automatic operation is selected with the remote controller, the microcomputer automatically determines the operation mode as cooling or heating according to the room temperature and the set temperature at start-up.

The unit automatically switches the operation mode to maintain the room temperature at the set temperature.

Detail

Ts: set temperature (set by remote controller)

Tt: target temperature (determined by microcomputer)

Tr: room thermistor temperature (detected by room temperature thermistor)

C: correction value

- The set temperature (Ts) determines the target temperature (Tt).
(Ts = 18 ~ 30°C, 64.4 ~ 86°F).
- The target temperature (Tt) is calculated as;

$$Tt = Ts + C$$
 where C is the correction value.

$$C = 0^{\circ}\text{C} (0^{\circ}\text{F})$$
- Thermostat ON/OFF point and operation mode switching point are as follows.
 Tr means the room thermistor temperature.
 - Heating → Cooling switching point:

$$Tr \geq Tt + 3.0^{\circ}\text{C} (+5.4^{\circ}\text{F})$$
 - Cooling → Heating switching point:

$$Tr < Tt - 3.0^{\circ}\text{C} (-5.4^{\circ}\text{F})$$
 - Thermostat ON/OFF point is the same as the ON/OFF point of cooling or heating operation.
- During initial operation

$$Tr \geq Ts : \text{Cooling operation}$$

$$Tr < Ts : \text{Heating operation}$$

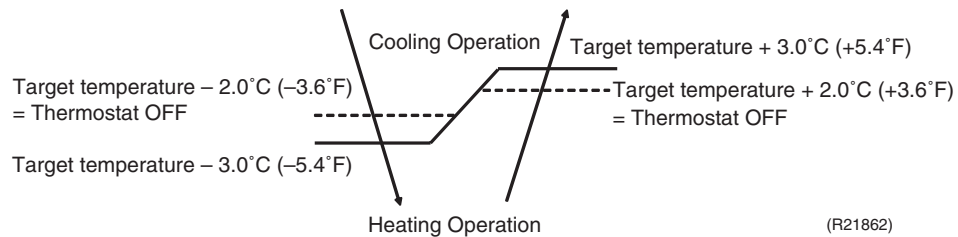

Ex: When the target temperature is 25°C (77°F)

Cooling → 23°C (73.4°F): Thermostat OFF → 22°C (71.6°F): Switch to heating

Heating → 27°C (80.6°F): Thermostat OFF → 28°C (82.4°F): Switch to cooling

1.7 Thermostat Control

Outline

Thermostat control is based on the difference between the room thermistor temperature and the target temperature.

Detail

Thermostat OFF Condition

- ◆ The temperature difference is in the zone A.

Thermostat ON Conditions

- ◆ The temperature difference returns to the zone C after being in the zone A.
- ◆ The system resumes from defrost control in any zones except A.
- ◆ The operation turns on in any zones except A.
- ◆ The monitoring time has passed while the temperature difference is in the zone B.
(Cooling: 10 minutes, Dry: 7.5 minutes, Heating: 10 seconds)

<Cooling / Dry>

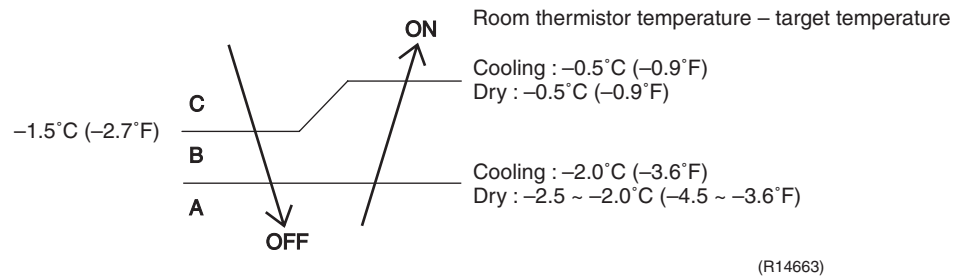

<Heating>

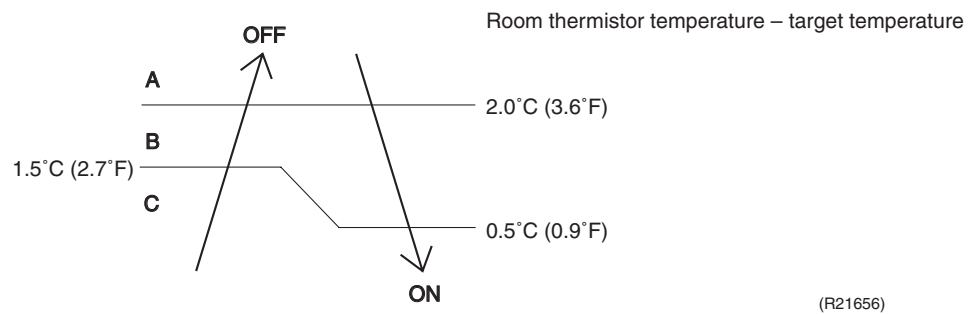

Refer to Temperature Control on page 23 for detail.

1.8 NIGHT SET Mode

Outline When the OFF TIMER is set, NIGHT SET Mode is automatically activated. NIGHT SET Mode keeps the airflow rate setting.

Detail NIGHT SET Mode continues operation at the target temperature for the first one hour, then automatically raises the target temperature slightly in the case of cooling, or lowers it slightly in the case of heating. This prevents excessive cooling in summer and excessive heating in winter to ensure comfortable sleeping conditions, and also conserves electricity.

<Cooling>

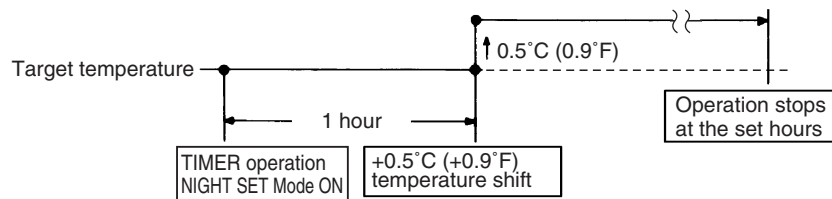

(R21657)

<Heating>

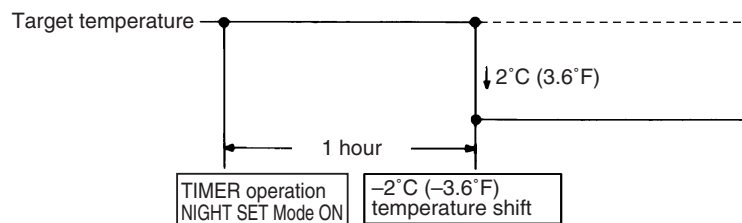

(R21658)

1.9 ECONO Operation

Outline ECONO operation reduces the maximum power consumption. This operation is particularly convenient for energy-saving. It is also a major bonus when breaker capacity does not allow the use of multiple electrical devices and air conditioners. It can be easily activated by pushing the **ECONO** button on the wireless remote controller.

Detail

- When this function is activated, the maximum capacity also decreases.
- The remote controller can send the ECONO command when the unit is in cooling, heating, dry, or automatic operation. This function can only be set when the unit is running. Press the **ON/OFF** button on the remote controller to cancel the function.
- This function and POWERFUL operation cannot be used at the same time. The latest command has the priority.

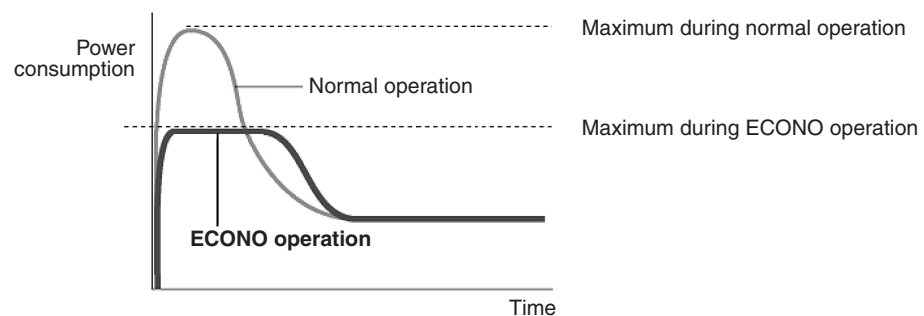

(R21051)

1.10 Inverter POWERFUL Operation

Outline

In order to exploit the cooling and heating capacity to full extent, the air conditioner can be operated by increasing the indoor fan rotating speed and the compressor frequency.

Detail

When **POWERFUL** button is pressed, the fan speed and target temperature are converted to the following states for 20 minutes.

Operation mode	Fan speed	Target temperature
COOL	H tap + A rpm	18°C (64.4°F)
DRY	Dry rotating speed + A rpm	Lowered by 2.5°C (4.5°F)
HEAT	H tap + A rpm	31°C (87.8°F)
FAN	H tap + A rpm	—
AUTO	Same as cooling / heating in POWERFUL operation	The target temperature is kept unchanged.

A = 09/12 class: 80 rpm
18/24 class: 50 rpm

Ex: POWERFUL operation in cooling

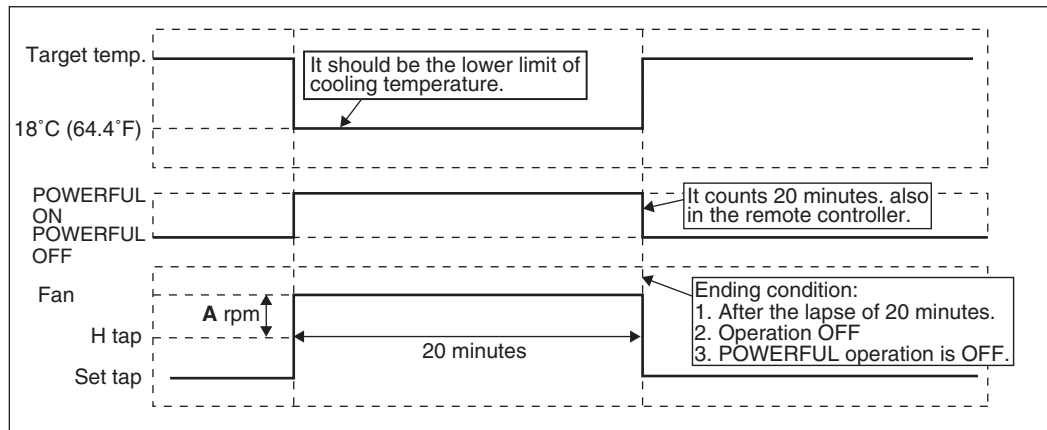

(R21659)



Note: POWERFUL operation cannot be used together with ECONO or COMFORT AIRFLOW operation.

1.11 Other Functions

1.11.1 Hot-Start Function

In order to prevent the cold air blast that normally occurs when heating operation starts, the temperature of the indoor heat exchanger is detected, and the airflow is either stopped or significantly weakened resulting in comfortable heating.

i Note: The cold air blast is prevented using similar control when defrost control starts or when the thermostat is turned ON.

1.11.2 Signal Receiving Sign

When the indoor unit receives a signal from the remote controller, the unit emits a signal receiving sound.

1.11.3 Indoor Unit ON/OFF Button

An **ON/OFF** button is provided on the display of the unit.

- Press the **ON/OFF** button once to start operation. Press once again to stop it.
- The **ON/OFF** button is useful when the remote controller is missing or the battery has run out.

	Mode	Temperature setting	Airflow rate
Cooling Only	COOL	22°C (72°F)	Automatic
Heat Pump	AUTO	25°C (77°F)	Automatic

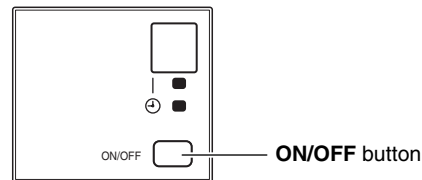

(R21052)

<Forced cooling operation>

Forced cooling operation can be started by pressing the **ON/OFF** button for 5 to 9 seconds while the unit is not operating.
Refer to page 103 for detail.

i Note: When the **ON/OFF** button is pressed for 10 seconds or more, the forced cooling operation is stopped.

1.11.4 Auto-restart Function

If a power failure (including one for just a moment) occurs during the operation, the operation restarts automatically when the power is restored in the same condition as before the power failure.

i Note: It takes 3 minutes to restart the operation because the 3-minute standby function is activated.

2. Function of Thermistor

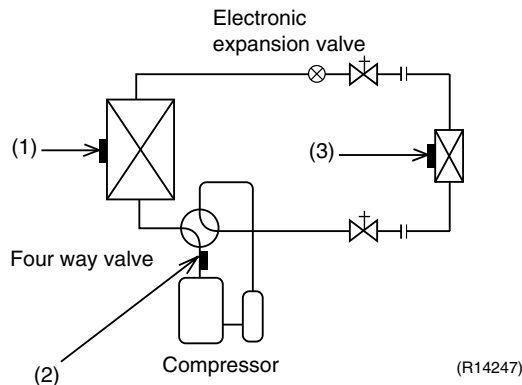

(1) Outdoor Heat Exchanger Thermistor

1. The outdoor heat exchanger thermistor is used for controlling the target discharge pipe temperature. The system sets the target discharge pipe temperature according to the outdoor and indoor heat exchanger temperature, and controls the electronic expansion valve opening so that the target discharge pipe temperature can be obtained.
2. In cooling operation, the outdoor heat exchanger thermistor is used for detecting the disconnection of the discharge pipe thermistor. When the discharge pipe temperature drops below the outdoor heat exchanger temperature by more than a certain value, the discharge pipe thermistor is judged as disconnected.
3. In cooling operation, the outdoor heat exchanger thermistor is used for high pressure protection.

(2) Discharge Pipe Thermistor

1. The discharge pipe thermistor is used for controlling discharge pipe temperature. If the discharge pipe temperature (used in place of the inner temperature of the compressor) rises abnormally, the operating frequency becomes lower or the operation halts.
2. The discharge pipe thermistor is used for detecting disconnection of the discharge pipe thermistor.

(3) Indoor Heat Exchanger Thermistor

1. The indoor heat exchanger thermistor is used for controlling the target discharge pipe temperature. The system sets the target discharge pipe temperature according to the outdoor and indoor heat exchanger temperature, and controls the electronic expansion valve opening so that the target discharge pipe temperature can be obtained.
2. In cooling operation, the indoor heat exchanger thermistor is used for freeze-up protection control. If the indoor heat exchanger temperature drops abnormally, the operating frequency becomes lower or the operation halts.
3. In heating operation, the indoor heat exchanger thermistor is used for detecting the disconnection of the discharge pipe thermistor. When the discharge pipe temperature drops below the indoor heat exchanger temperature by more than a certain value, the discharge pipe thermistor is judged as disconnected.

3. Control Specification

3.1 Mode Hierarchy

Outline The air conditioner control has normal operation mode, forced operation mode, and power transistor test mode for installation and servicing.

Detail **Cooling Only Model**

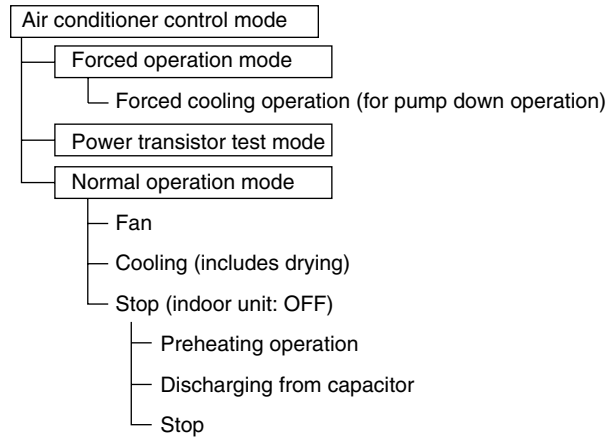

(R19505)

Heat Pump Model

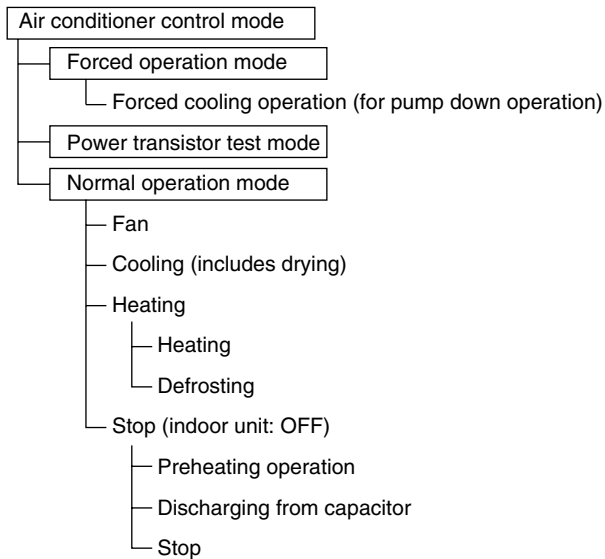

(R19522)



Note: Unless specified otherwise, a dry operation command is regarded as cooling operation.

3.2 Frequency Control

Outline

The compressor frequency is determined according to the difference between the room thermistor temperature and the target temperature.

When the shift of the frequency is less than zero ($\Delta F < 0$) by PI control, the target frequency is used as the command frequency.

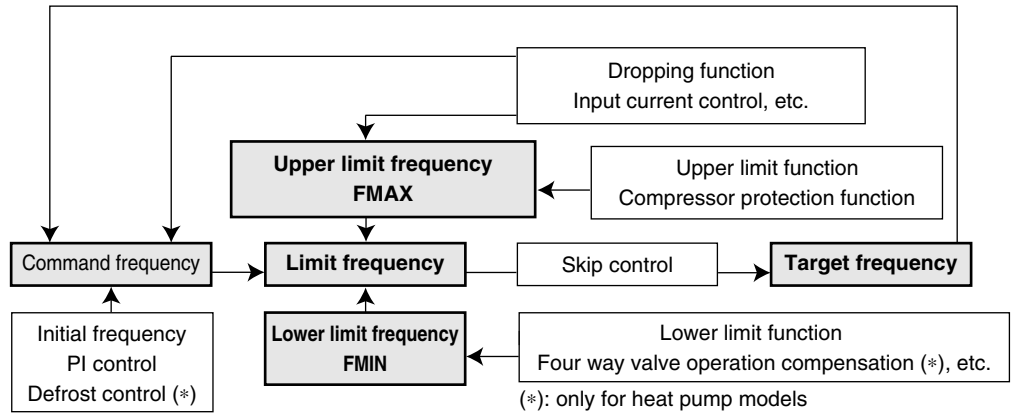

Detail

For Cooling Only Model

1. Determine command frequency

Command frequency is determined in the following order of priority.

1. Forced cooling
2. Indoor frequency command

2. Determine upper limit frequency

The minimum value is set as an upper limit frequency among the frequency upper limits of the following functions:

Compressor protection, input current, discharge pipe temperature, freeze-up protection.

3. Determine lower limit frequency

The maximum value is set as a lower limit frequency among the frequency lower limits of the following function:

Pressure difference upkeep.

4. Determine prohibited frequency

There is a certain prohibited frequency such as a power supply frequency.

For Heat Pump Model

1. Determine command frequency

Command frequency is determined in the following order of priority.

1. Limiting defrost control time
2. Forced cooling
3. Indoor frequency command

2. Determine upper limit frequency

The minimum value is set as an upper limit frequency among the frequency upper limits of the following functions:

Compressor protection, input current, discharge pipe temperature, heating peak-cut, freeze-up protection, defrost control.

3. Determine lower limit frequency

The maximum value is set as a lower limit frequency among the frequency lower limits of the following functions:

Four way valve operation compensation, draft prevention, pressure difference upkeep.

4. Determine prohibited frequency

There is a certain prohibited frequency such as a power supply frequency.

Initial Frequency

When starting the compressor, the frequency is initialized according to the ΔD value of the indoor unit.

< ΔD signal: Indoor frequency command>

The difference between the room thermistor temperature and the target temperature is recognized as the ΔD signal and is used for frequency command.

Temperature difference	ΔD signal	Temperature difference	ΔD signal	Temperature difference	ΔD signal	Temperature difference	ΔD signal
-2.0°C (-3.6°F)	*OFF	0°C (0°F)	4	2.0°C (3.6°F)	8	4.0°C (7.2°F)	C
-1.5°C (-2.7°F)	1	0.5°C (0.9°F)	5	2.5°C (4.5°F)	9	4.5°C (8.1°F)	D
-1.0°C (-1.8°F)	2	1.0°C (1.8°F)	6	3.0°C (5.4°F)	A	5.0°C (9.0°F)	E
-0.5°C (-0.9°F)	3	1.5°C (2.7°F)	7	3.5°C (6.3°F)	B	5.5°C (9.9°F)	F

*OFF = Thermostat OFF

PI Control**1. P control**

The ΔD value is calculated in each sampling time (20 seconds), and the frequency is adjusted according to its difference from the frequency previously calculated.

2. I control

If the operating frequency does not change for more than a certain fixed time, the frequency is adjusted according to the ΔD value.

When the ΔD value is low, the frequency is lowered.

When the ΔD value is high, the frequency is increased.

3. Frequency control when other controls are functioning

- ◆ When frequency is dropping;
Frequency control is carried out only when the frequency drops.
- ◆ For limiting lower limit;
Frequency control is carried out only when the frequency rises.

4. Upper and lower limit of frequency by PI control

The frequency upper and lower limits are set according to the command of the indoor unit.

When the indoor or outdoor unit quiet operation command comes from the indoor unit, the upper limit frequency is lower than the usual setting.

3.3 Controls at Mode Changing / Start-up

3.3.1 Preheating Operation

Outline The inverter operation in open phase starts with the conditions of the outdoor temperature, the discharge pipe temperature, the radiation fin temperature and the preheating command from the indoor unit.

Detail Outdoor temperature $\geq -2.5^{\circ}\text{C}$ (27.5°F) \rightarrow Control A (preheating for normal state)
Outdoor temperature $< -2.5^{\circ}\text{C}$ (27.5°F) \rightarrow Control B (preheating of increased capacity)

Control A

- ◆ ON condition
 - Discharge pipe temperature $< 0^{\circ}\text{C}$ (32.0°F)
 - Radiation fin temperature $< 85^{\circ}\text{C}$ (185°F)
- ◆ OFF condition
 - Discharge pipe temperature $> 2^{\circ}\text{C}$ (35.6°F)
 - Radiation fin temperature $\geq 90^{\circ}\text{C}$ (194°F)

Control B

- ◆ ON condition
 - Discharge pipe temperature $< 10^{\circ}\text{C}$ (50.0°F)
 - Radiation fin temperature $< 85^{\circ}\text{C}$ (185°F)
- ◆ OFF condition
 - Discharge pipe temperature $> 12^{\circ}\text{C}$ (53.6°F)
 - Radiation fin temperature $\geq 90^{\circ}\text{C}$ (194°F)

3.3.2 Four Way Valve Switching

Outline The four way valve coil is energized / not energized depending on the operation. (Heating: ON, Cooling / Dry / Defrost: OFF)
In order to eliminate the switching sound as the four way valve coil switches from ON to OFF when the heating is stopped, the OFF delay switch of the four way valve is carried out.

Detail **OFF delay switch of four way valve**
The four way valve coil is energized for 160 seconds after the operation is stopped.

3.3.3 Four Way Valve Operation Compensation

Outline

At the beginning of operation as the four way valve is switched, the pressure difference to activate the four way valve is acquired when the output frequency is higher than a certain fixed frequency, for a certain fixed time.

Detail

Starting Conditions

1. When the compressor starts and the four way valve switches from OFF to ON
2. When the four way valve switches from ON to OFF during operation
3. When the compressor starts after resetting
4. When the compressor starts after the fault of four way valve switching

The lower limit of frequency keeps **A** Hz for **B** seconds with any conditions 1 through 4 above.

When the outdoor temperature is above **C** °C in heating, the frequency decreases depending on the outdoor temperature.

	09/12 class RKN18NMVJU		RXN18NMVJU RK(X)18NMVJU 24 class	
	Cooling	Heating	Cooling	Heating
A (Hz)	40	54	48	
B (seconds)	60		70	
C	(°C)	10	15	
	(°F)	50	59	

3.3.4 3-minute Standby

Turning on the compressor is prohibited for 3 minutes after turning it off.
(The function is not activated when defrosting.)

3.3.5 Compressor Protection Function

When turning the compressor from OFF to ON, the upper limit of frequency is set as follows.
(The function is not activated when defrosting.)

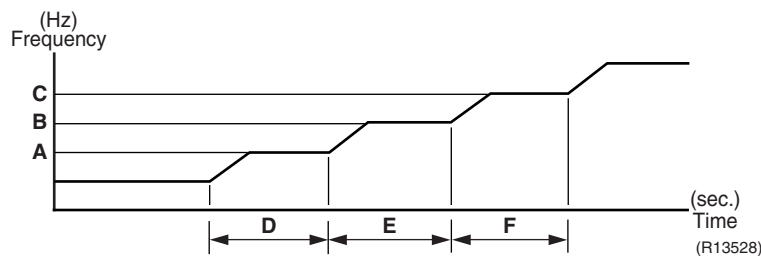

	09/12 class RKN18NMVJU	RXN18NMVJU RK(X)18NMVJU 24 class
A (Hz)	40	52
B (Hz)	54	68
C (Hz)	72	80
D (seconds)	180	300
E (seconds)	420	200
F (seconds)	180	460

3.4 Discharge Pipe Temperature Control

Outline

The discharge pipe temperature is used as the internal temperature of the compressor. If the discharge pipe temperature rises above a certain level, the upper limit of frequency is set to keep the discharge pipe temperature from rising further.

Detail

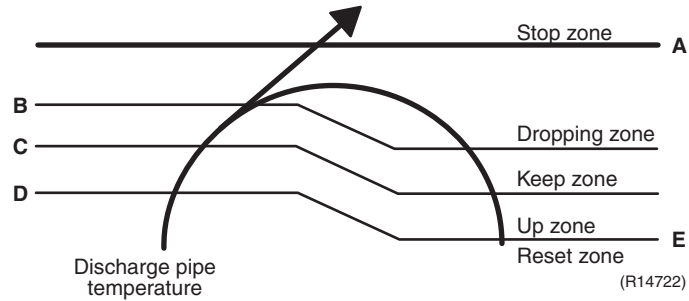

Zone	Control
Stop zone	When the temperature reaches the stop zone, the compressor stops.
Dropping zone	The upper limit of frequency decreases.
Keep zone	The upper limit of frequency is kept.
Up zone	The upper limit of frequency increases.
Reset zone	The upper limit of frequency is canceled.

	09/12 class RKN18NMVJU		RXN18NMVJU RK(X)18NMVJU 24 class	
	(°C)	(°F)	(°C)	(°F)
A	110	230.0	110	230.0
B	103	217.4	103	217.4
C	98	208.4	101.5	214.7
D	93	199.4	100	212.0
E	88	190.4	95	203.0

3.5 Input Current Control

Outline

The microcomputer calculates the input current while the compressor is running, and sets the frequency upper limit based on the input current.

In case of heat pump models, this control is the upper limit control of frequency and takes priority over the lower limit control of four way valve operation compensation.

Detail

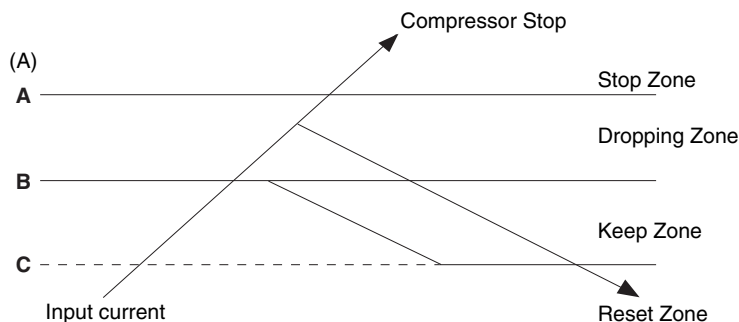

(R14723)

Frequency control in each zone

Stop zone

- ◆ After 2.5 seconds in this zone, the compressor is stopped.

Dropping zone

- ◆ The upper limit of the compressor frequency is defined as operation frequency – 2 Hz.
- ◆ After this, the output frequency is pulled down by 2 Hz every second until it reaches the keep zone.

Keep zone

- ◆ The present maximum frequency goes on.

Reset zone

- ◆ Limit of the frequency is canceled.

■ RK(X)N series

	RK(X)N09NMVJU		RK(X)N12NMVJU	
	Cooling	Heating	Cooling	Heating
A (A)	7.75	10	8.5	10
B (A)	6.75	8.5	7.5	8.5
C (A)	5.75	7.5	6.5	7.5

	RKN18NMVJU		RXN18NMVJU		RK(X)N24NMVJU	
	Cooling	Heating	Cooling	Heating	Cooling	Heating
A (A)	9.25	—	13		18	
B (A)	8.5	—	10	9	12	14.5
C (A)	7.5	—	9	8	11	13.5

■ RK(X) series

	RK(X)09NMVJU		RK(X)12NMVJU		RK(X)18NMVJU		RK(X)24NMVJU	
	Cooling	Heating	Cooling	Heating	Cooling	Heating	Cooling	Heating
A (A)	12		12		18		18	
B (A)	6.75	8.5	7.5	8.5	10	10.75	12	11.5
C (A)	5.75	7.5	6.5	7.5	9	9.75	11	10.5

Limitation of current dropping and stop value according to the outdoor temperature

- ◆ The current drops when outdoor temperature becomes higher than a certain level (depending on the model).

3.6 Freeze-up Protection Control

During cooling operation, the signal sent from the indoor unit determines the frequency upper limit and prevents freezing of the indoor heat exchanger. (The signal from the indoor unit is divided into zones.)

The operating frequency limitation is judged with the indoor heat exchanger temperature.

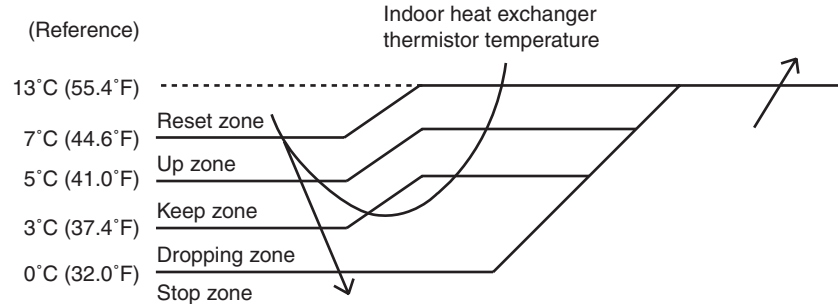

(R21660)

3.7 Heating Peak-cut Control

During heating operation, the indoor heat exchanger temperature determines the frequency upper limit to prevent abnormal high pressure.

The operating frequency limitation is judged with the indoor heat exchanger temperature.

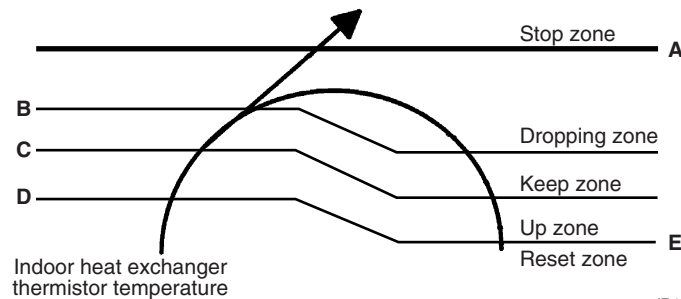

(R14665)

	09/12 class		RXN18NMVJU RX18NMVJU 24 class	
	(°C)	(°F)	(°C)	(°F)
A	59	138.2	60	140.0
B	55	131.0	54	129.2
C	52	125.6	51	123.8
D	50	122.0	49	120.2
E	45	113.0	44	111.2

Zone	Control
Stop zone	When the temperature reaches the stop zone, the compressor stops.
Dropping zone	The upper limit of frequency decreases.
Keep zone	The upper limit of frequency is kept.
Up zone	The upper limit of frequency increases.
Reset zone	The upper limit of frequency is canceled.

3.8 Outdoor Fan Control

1. Fan ON control to cool down the electrical box

The outdoor fan is turned ON when the electrical box temperature is high while the compressor is OFF.

2. Fan OFF control during defrosting

The outdoor fan is turned OFF during defrosting.

3. Fan OFF delay when stopped

The outdoor fan is turned OFF 60 ~ 70 seconds after the compressor stops.

4. Fan speed control for pressure difference upkeep

The rotation speed of the outdoor fan is controlled for keeping the pressure difference during cooling operation with low outdoor temperature.

- ◆ When the pressure difference is low, the rotation speed of the outdoor fan is reduced.
- ◆ When the pressure difference is high, the rotation speed of the outdoor fan is controlled as well as normal operation.

5. Fan speed control during forced cooling operation

The outdoor fan is controlled as well as normal operation during forced cooling operation.

6. Fan speed control during POWERFUL operation

The rotation speed of the outdoor fan is increased during POWERFUL operation.

7. Fan speed control during indoor / outdoor unit quiet operation

The rotation speed of the outdoor fan is reduced by the command of the indoor / outdoor unit quiet operation.

8. Fan ON/OFF control when operation (cooling, heating, dry) starts / stops

The outdoor fan is turned ON when the operation starts. The outdoor fan is turned OFF when the operation stops.

3.9 Liquid Compression Protection Function

Outline

In order to obtain the dependability of the compressor, the compressor is stopped according to the outdoor temperature and temperature of the outdoor heat exchanger.

Detail

Operation stops depending on the outdoor temperature

Compressor turns off under the conditions that the system is in cooling operation and outdoor temperature is below 0°C (32°F).

3.10 Defrost Control

Outline

Defrosting is carried out by the cooling cycle (reverse cycle). The defrosting time or outdoor heat exchanger temperature must be more than a certain value to finish defrosting.

Detail

Conditions for Starting Defrost

- The starting conditions are determined with the outdoor temperature and the outdoor heat exchanger temperature.
- The system is in heating operation.
- The compressor operates for 6 minutes.
- More than **A** minutes (depending on the duration of the previous defrost control) of accumulated time have passed since the start of the operation, or ending the previous defrosting.

Conditions for Canceling Defrost

The judgment is made with the outdoor heat exchanger temperature (**B**°C).

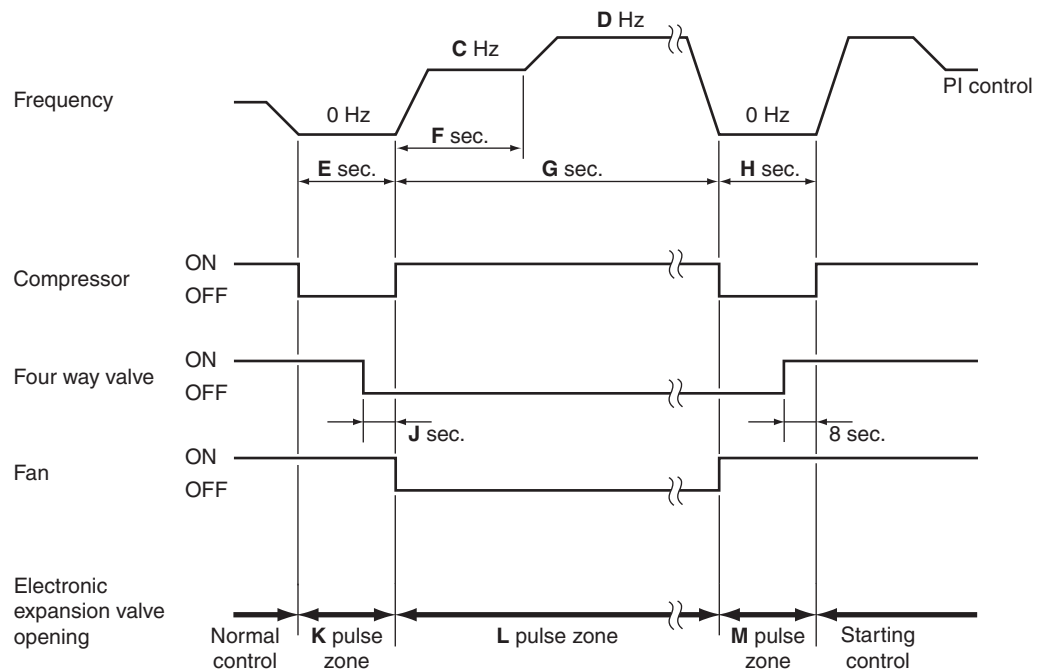

(R21661)

	09 class	12 class	18 class RXN24NMVJU	RX24NMVJU
A (minute)	20 ~ 25	20 ~ 25	25	25
B	(°C)	2 ~ 20	6 ~ 30	6 ~ 30
	(°F)	35.6 ~ 68.0	35.6 ~ 68.0	42.8 ~ 86.0
C (Hz)	64	64	48	48
D (Hz)	64	64	42	42
E (seconds)	40	40	60	60
F (seconds)	60	60	60	60
G (seconds)	630	630	490	490
H (seconds)	40	50	60	90
J (seconds)	8	8	5	5
K (pulse)	400	400	450	450
L (pulse)	300	300	300 ~ 450	300 ~ 450
M (pulse)	200	350	200	200

3.11 Electronic Expansion Valve Control

Outline

The following items are included in the electronic expansion valve control.

Electronic expansion valve is fully closed

1. Electronic expansion valve is fully closed when turning on the power.
2. Pressure equalizing control

Open Control

1. Electronic expansion valve control when starting operation
2. Electronic expansion valve control when the frequency changes
3. Electronic expansion valve control for defrosting
4. Electronic expansion valve control when the discharge pipe temperature is abnormally high
5. Electronic expansion valve control when the discharge pipe thermistor is disconnected

Feedback Control

Target discharge pipe temperature control

Detail

The followings are the examples of electronic expansion valve control which function in each operation mode.

	Status							
Control	Power on : Compressor stop	Operation start	Frequency change under starting control	During target discharge pipe temperature control	Frequency change under target discharge pipe temperature control	Discharge pipe thermistor disconnection	Frequency change under discharge pipe thermistor disconnection control	During defrost control
Starting operation control	—	●	—	—	—	—	—	—
Control when the frequency changes	—	—	●	—	●	—	—	—
Target discharge pipe temperature control	—	—	—	●	—	—	—	—
Discharge pipe thermistor disconnection control	—	—	—	—	—	●	●	—
High discharge pipe temperature control	—	●	●	●	●	—	—	—
Defrost control (heating only)	—	—	—	—	—	—	—	●
Pressure equalizing control	●	—	—	—	—	—	—	—
Opening limit control	—	●	●	●	●	●	●	—

- : Available
- : Not available

3.11.1 Fully Closing with Power ON

The electronic expansion valve is initialized when turning on the power. The opening position is set and the pressure is equalized.

3.11.2 Pressure Equalizing Control

When the compressor is stopped, the pressure equalizing control is activated. The electronic expansion valve opens and the pressure is equalized.

3.11.3 Opening Limit Control

The maximum and minimum opening of the electronic expansion valve are limited.

	09/12 class	RKN18NMVJU	RXN18NMVJU RK(X)18NMVJU 24 class
Maximum opening (pulse)	470	470	480
Minimum opening (pulse)	32	52	52

The electronic expansion valve is fully closed when cooling operation stops, and is opened at a fixed degree during defrosting.

3.11.4 Starting Operation Control

The electronic expansion valve opening is controlled when the operation starts, thus prevents the superheating or liquid compression.

3.11.5 Control when the frequency changes

When the target discharge pipe temperature control is active, if the target frequency changes to a specified value in a certain time period, the target discharge pipe temperature control is canceled and the target opening of the electronic expansion valve is changed according to the frequency shift.

3.11.6 High Discharge Pipe Temperature Control

When the compressor is operating, if the discharge pipe temperature exceeds a certain value, the electronic expansion valve opens and the refrigerant runs to the low pressure side. This procedure lowers the discharge pipe temperature.

3.11.7 Discharge Pipe Thermistor Disconnection Control

Outline

The disconnection of the discharge pipe thermistor is detected by comparing the discharge pipe temperature with the condensation temperature. If the discharge pipe thermistor is disconnected, the electronic expansion valve opens according to the outdoor temperature and the operation frequency, operates for a specified time, and then stops.

After 3 minutes, the operation restarts and checks if the discharge pipe thermistor is disconnected. If the discharge pipe thermistor is disconnected, the system stops after operating for a specified time.

If the disconnection is detected repeatedly, the system is shut down. When the compressor runs for 60 minutes without any error, the error counter is reset.

Detail

Determining thermistor disconnection

When the starting control finishes, the detection timer for disconnection of the discharge pipe thermistor (**A** seconds) starts. When the timer is over, the following adjustment is made.

1. When the operation mode is cooling

When the following condition is fulfilled, the discharge pipe thermistor disconnection is ascertained.

- Discharge pipe temperature $+6^{\circ}\text{C}$ ($+10.8^{\circ}\text{F}$) < outdoor heat exchanger temperature
2. When the operation mode is heating
When the following condition is fulfilled, the discharge pipe thermistor disconnection is ascertained.
Discharge pipe temperature $+6^{\circ}\text{C}$ ($+10.8^{\circ}\text{F}$) < indoor heat exchanger temperature

	09/12 class RKN18NMVJU	RXN18NMVJU RK(X)18NMVJU 24 class
A (seconds)	720	540

When the thermistor is disconnected

When the disconnection is ascertained, the compressor continues operation for 9 minutes and then stops.

If the compressor stops repeatedly, the system is shut down.

3.11.8 Target Discharge Pipe Temperature Control

The target discharge pipe temperature is obtained from the indoor and outdoor heat exchanger temperature, and the electronic expansion valve opening is adjusted so that the actual discharge pipe temperature becomes close to the target discharge pipe temperature. (Indirect SH (superheating) control using the discharge pipe temperature)

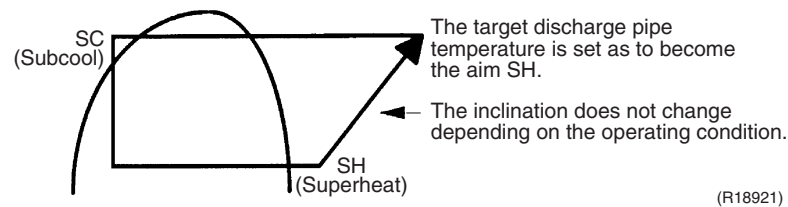

The electronic expansion valve opening and the target discharge pipe temperature are adjusted every **A** seconds. The opening degree of the electronic expansion valve is adjusted by the followings.

- ◆ Target discharge pipe temperature
- ◆ Actual discharge pipe temperature
- ◆ Previous discharge pipe temperature

	09/12 class RKN18NMVJU	RXN18NMVJU RK(X)18NMVJU 24 class
A (seconds)	10 ~ 30 ★	20

★ The time depends on the opening of the electronic expansion valve.

3.12 Malfunctions

3.12.1 Sensor Malfunction Detection

Sensor malfunction can be detected in the following thermistor:

1. Outdoor heat exchanger thermistor
2. Discharge pipe thermistor
3. Radiation fin thermistor
4. Outdoor temperature thermistor

3.12.2 Detection of Overcurrent and Overload

Outline

An excessive output current is detected and the OL temperature is observed to protect the compressor.

Detail

- If the OL (compressor head) temperature exceeds 130°C (266°F), the system shuts down the compressor.
- If the inverter current exceeds 7.75 ~ 18.0 A (depending on the model), the system shuts down the compressor.
The upper limit of the current decreases when the outdoor temperature exceeds a certain level.

Part 5

Remote Controller

1. Cooling Only.....	49
2. Heat Pump	51

1. Cooling Only

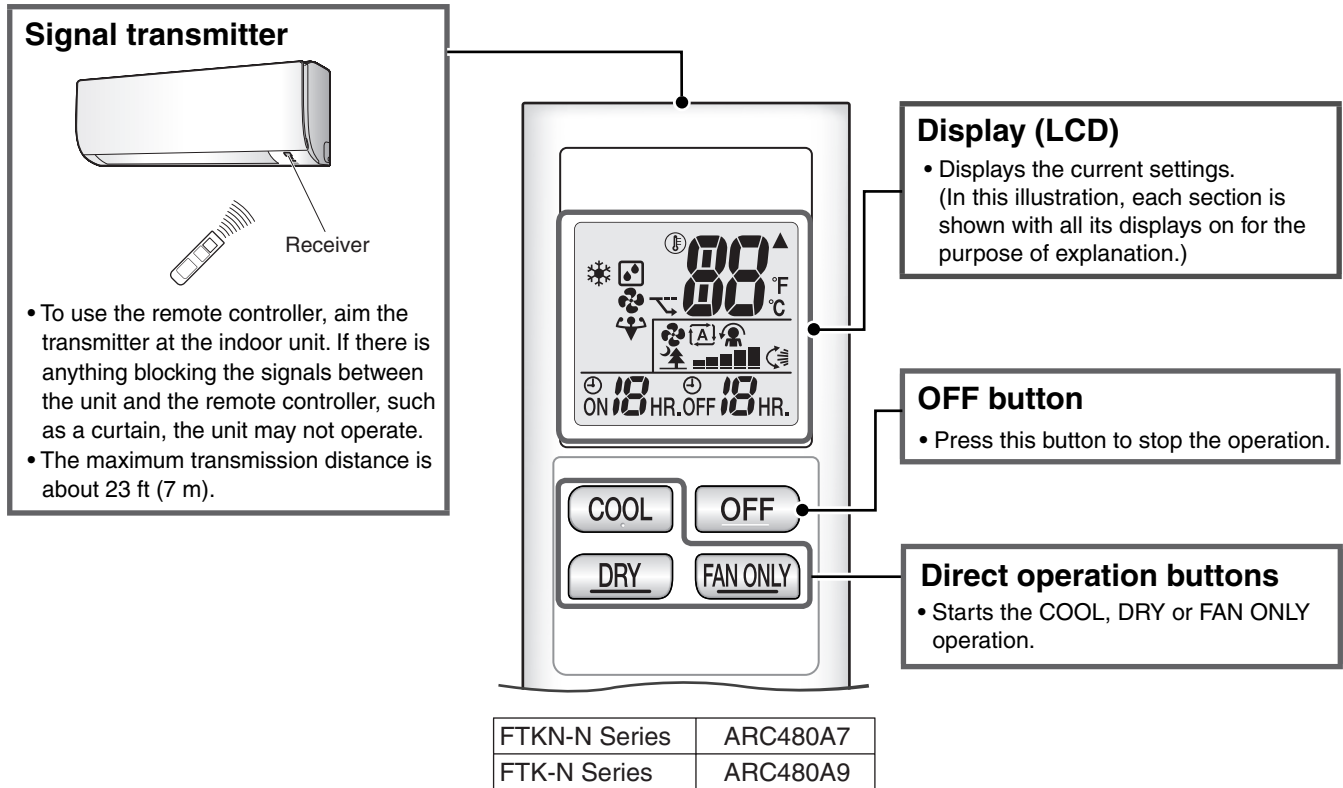

(R21662)



Note: Refer to the operation manual of applicable model for detail. You can download operation manual from Daikin Business Portal:
 Daikin Business Portal → Product Information → Operation/Installation Manual
 (URL: https://global1d.daikin.com/business_portal/login/)

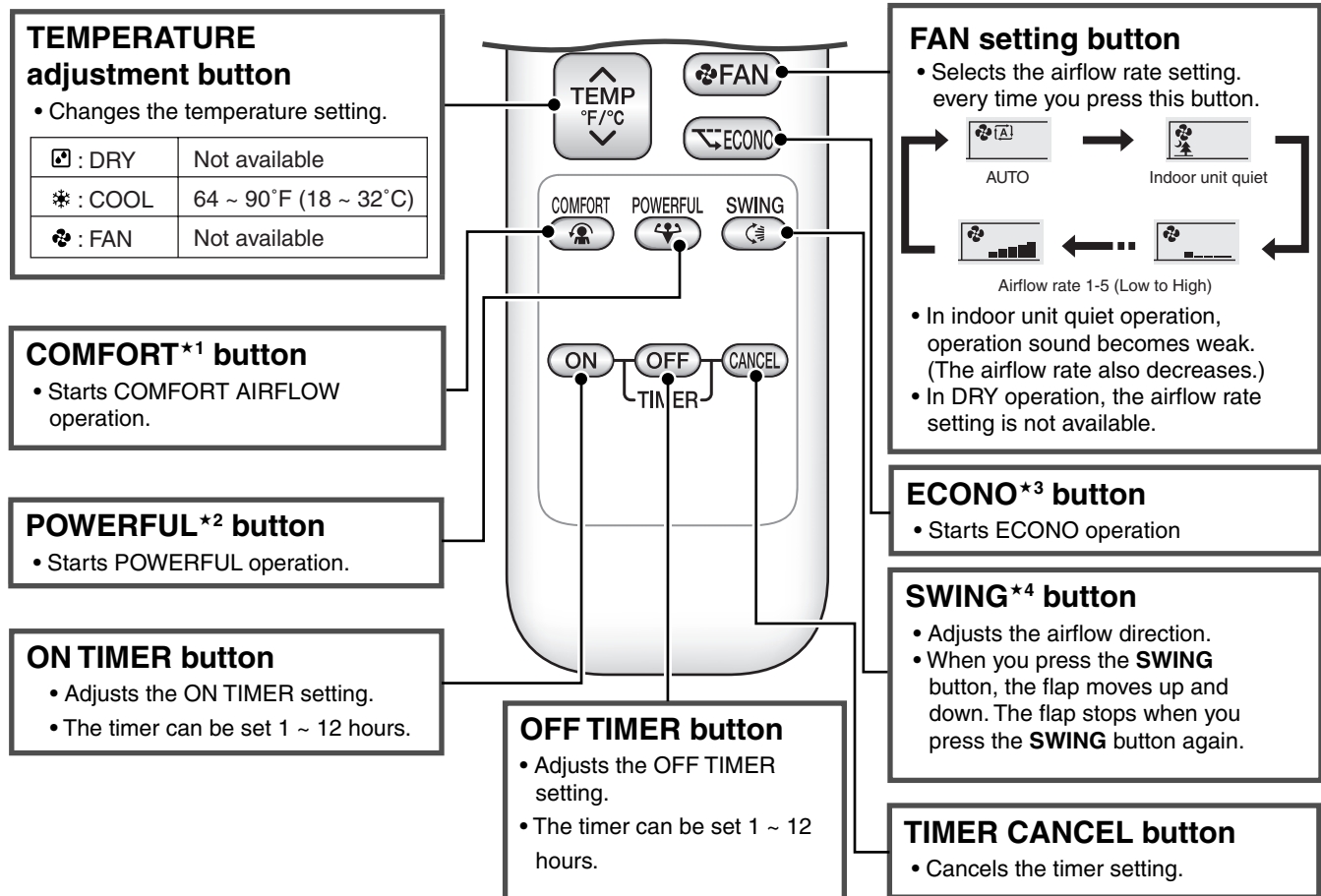

(R21663)

Reference

Refer to the following pages for detail.

★1	COMFORT AIRFLOW operation	P.25 P.26	★3	ECONO operation	P.30
★2	POWERFUL operation	P.31	★4	Auto-swing setting	P.25



Note: Refer to the operation manual of applicable model for detail. You can download operation manual from Daikin Business Portal:
 Daikin Business Portal → Product Information → Operation/Installation Manual
 (URL: https://global1d.daikin.com/business_portal/login/)

2. Heat Pump

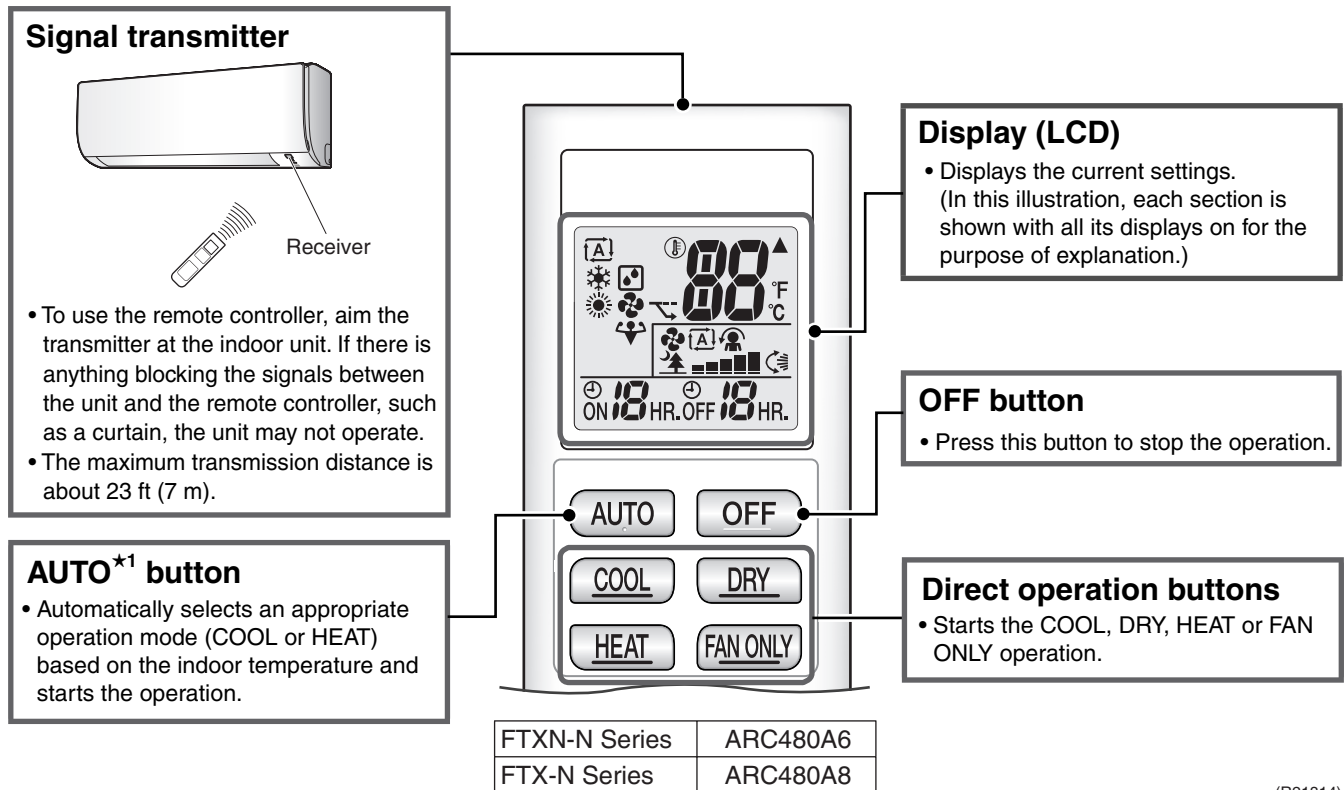

(R21814)

Reference

Refer to the following pages for detail.

★1	Automatic operation	P.26
----	---------------------	------



Note: Refer to the operation manual of applicable model for detail. You can download operation manual from Daikin Business Portal:
 Daikin Business Portal → Product Information → Operation/Installation Manual
 (URL: https://global1d.daikin.com/business_portal/login/)

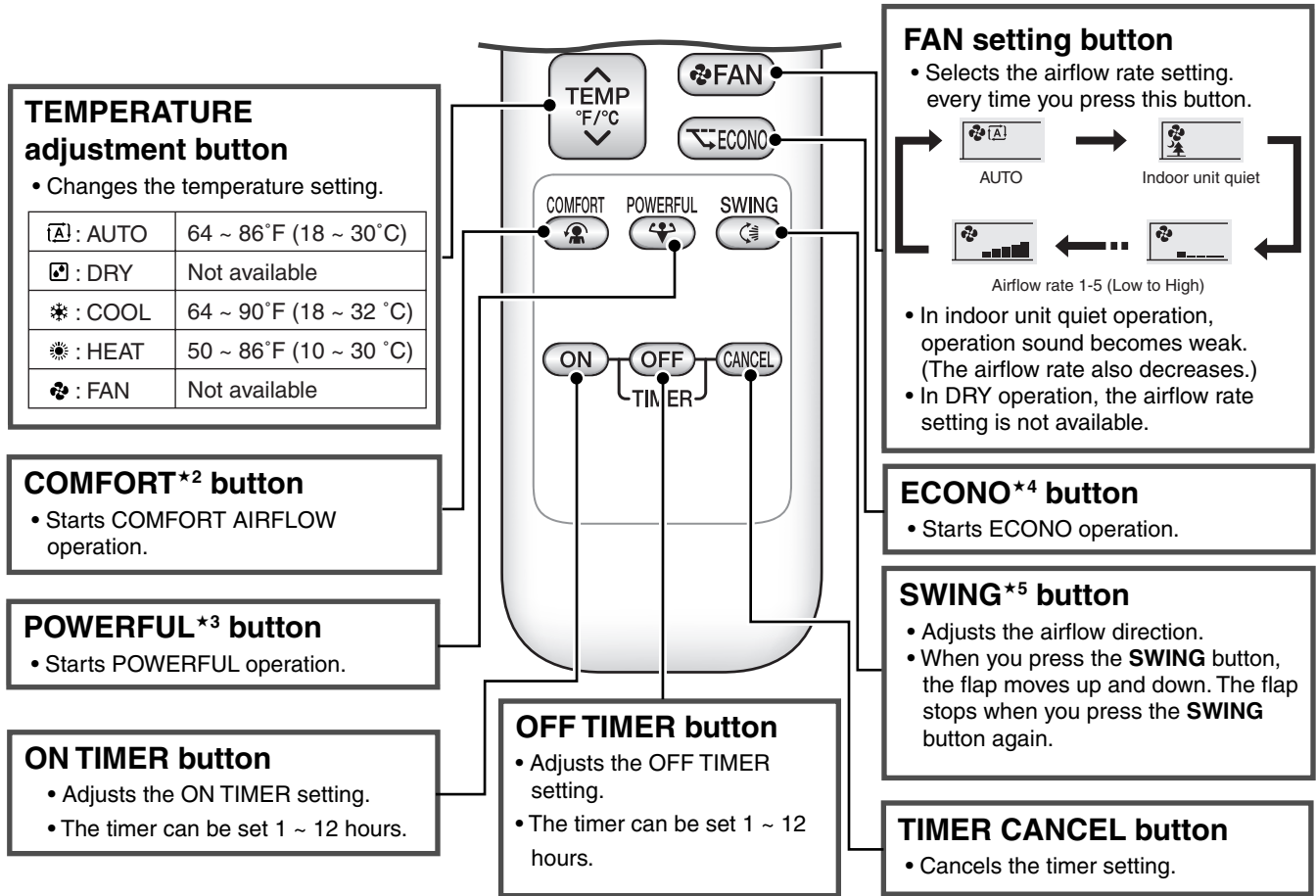

(R21664)

Reference

Refer to the following pages for detail.

★2	COMFORT AIRFLOW operation	P.25 P.26	★4	ECONO operation	P.30
★3	POWERFUL operation	P.31	★5	Auto-swing setting	P.25



Note:

Refer to the operation manual of applicable model for detail. You can download operation manual from Daikin Business Portal:
 Daikin Business Portal → Product Information → Operation/Installation Manual
 (URL: https://global1d.daikin.com/business_portal/login/)

Part 6

Service Diagnosis

1. General Problem Symptoms and Check Items	55
2. Troubleshooting with LED	56
2.1 Indoor Unit.....	56
2.2 Outdoor Unit	56
3. Service Diagnosis	57
4. Troubleshooting	60
4.1 Error Codes and Description	60
4.2 Indoor Unit PCB Abnormality	61
4.3 Freeze-up Protection Control / Heating Peak-cut Control	62
4.4 Fan Motor (DC Motor) or Related Abnormality.....	63
4.5 Thermistor or Related Abnormality (Indoor Unit).....	65
4.6 Low-voltage Detection or Over-voltage Detection.....	66
4.7 Signal Transmission Error (between Indoor Unit and Outdoor Unit)	68
4.8 Unspecified Voltage (Between Indoor Unit and Outdoor Unit)	70
4.9 Outdoor Unit PCB Abnormality.....	71
4.10 OL Activation (Compressor Overload)	72
4.11 Compressor Lock	74
4.12 DC Fan Lock	75
4.13 Input Overcurrent Detection	76
4.14 Four Way Valve Abnormality.....	77
4.15 Discharge Pipe Temperature Control.....	79
4.16 High Pressure Control in Cooling	80
4.17 Compressor System Sensor Abnormality	82
4.18 Position Sensor Abnormality	83
4.19 Thermistor or Related Abnormality (Outdoor Unit).....	85
4.20 Electrical Box Temperature Rise.....	87
4.21 Radiation Fin Temperature Rise	88
4.22 Output Overcurrent Detection	89
5. Check	91
5.1 Thermistor Resistance Check	91
5.2 Fan Motor Connector Output Check	92
5.3 Power Supply Waveforms Check.....	93
5.4 Electronic Expansion Valve Check.....	93
5.5 Four Way Valve Performance Check	94
5.6 Inverter Unit Refrigerant System Check.....	94
5.7 Inverter Analyzer Check.....	95
5.8 Rotation Pulse Check on the Outdoor Unit PCB	97
5.9 Installation Condition Check.....	98
5.10 Discharge Pressure Check.....	98
5.11 Outdoor Fan System Check.....	99
5.12 Main Circuit Short Check.....	99

5.13 Power Module Check 100

1. General Problem Symptoms and Check Items

Symptom	Check Item	Details	Reference Page
The unit does not operate.	Check the power supply.	Check if the rated voltage is supplied.	—
	Check the type of the indoor unit.	Check if the indoor unit type is compatible with the outdoor unit.	—
	Check the outdoor temperature.	Heating operation cannot be used when the outdoor temperature is 18°CWB (64.4°F WB) or higher, and cooling operation cannot be used when the outdoor temperature is below 10°CDB (50°F DB).	—
	Diagnose with remote controller indication.	—	60
	Check the remote controller addresses.	Check if address settings for the remote controller and indoor unit are correct.	106
Operation sometimes stops.	Check the power supply.	A power failure of 2 to 10 cycles stops air conditioner operation. (Operation lamp OFF)	—
	Check the outdoor temperature.	Heating operation cannot be used when the outdoor temperature is 18°CWB (64.4°F WB) or higher, and cooling operation cannot be used when the outdoor temperature is below 10°CDB (50°F DB).	—
	Diagnose with remote controller indication.	—	60
The unit operates but does not cool, or does not heat.	Check for wiring and piping errors in the connection between the indoor unit and outdoor unit.	—	—
	Check for thermistor detection errors.	Check if the thermistor is mounted securely.	—
	Check for faulty operation of the electronic expansion valve.	Set the unit to cooling operation, and check the temperature of the liquid pipe to see if the electronic expansion valve works.	—
	Diagnose with remote controller indication.	—	60
	Diagnose by service port pressure and operating current.	Check for refrigerant shortage.	—
Large operating noise and vibrations	Check the output voltage of the power module.	—	100
	Check the power module.	—	—
	Check the installation condition.	Check if the required spaces for installation (specified in the installation manual) are provided.	—

2. Troubleshooting with LED

2.1 Indoor Unit

Operation Lamp

The operation lamp blinks when any of the following errors is detected.

1. When a protection device of the indoor or outdoor unit is activated, or when the thermistor malfunctions.
 2. When a signal transmission error occurs between the indoor and outdoor units.
- In either case, conduct the diagnostic procedure described in the following pages.

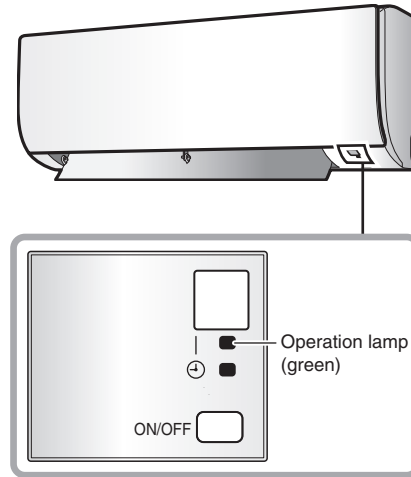

(R21056)

2.2 Outdoor Unit

The outdoor unit has one green LED (LED A) on the PCB. When the microcomputer works in order, the LED A blinks. However, the LED A turns OFF while the standby electricity saving function is activated and the power supply is OFF. (Refer to page 20, 21 for the location of LED A.)

3. Service Diagnosis

Method 1

1. When the **TIMER CANCEL** button is held down for 5 seconds, **00** is displayed on the temperature display screen.



(R21665)

2. Press the **TIMER CANCEL** button repeatedly until a long beep sounds.
 - The code indication changes in the sequence shown below.

No.	Code	No.	Code	No.	Code
1	00	16	R3	31	UF
2	R5	17	M8	32	UM
3	E7	18	M9	33	P4
4	F3	19	C9	34	M7
5	F6	20	CC	35	U2
6	L3	21	C4	36	ER
7	L4	22	C5	37	RM
8	L5	23	J3	38	FR
9	U4	24	J6	39	EB
10	E6	25	J8	40	CH
11	M6	26	E5	41	J9
12	M0	27	R1	42	E3
13	R6	28	E1	43	M3
14	U0	29	UR		
15	C7	30	U3		



Note:

1. A short beep and two consecutive beeps indicate non-corresponding codes.
2. To return to the normal mode, hold the **TIMER CANCEL** button down for 5 seconds. When the remote controller is left untouched for 60 seconds, it also returns to the normal mode.
3. Not all the error codes are displayed. When you cannot find the error code, try method 2. (→ Refer to page 58.)

Method 2

1. Press the center of the **TEMP** button and the **OFF** button at the same time.

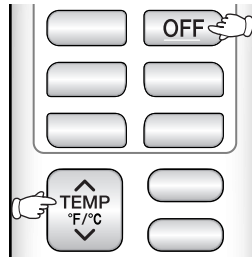

(R21666)

5C is displayed on the LCD.

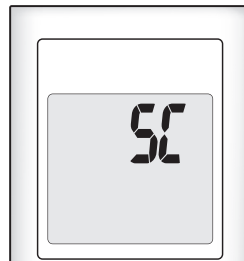

(R21059)

2. Select 5C (service check) with the **TEMP** \wedge or **TEMP** \vee button.
3. Press the **FAN** button to enter the service check mode.

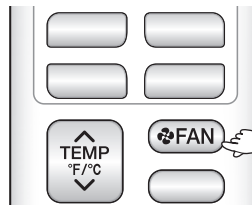

(R21667)

00 is displayed and the left-side number blinks.

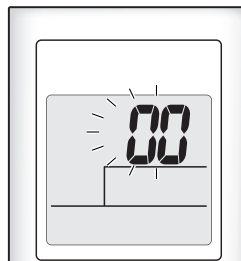

(R21061)

4. Press the **TEMP** \wedge or **TEMP** \vee button and change the number until you hear the two consecutive beeps or the long beep.

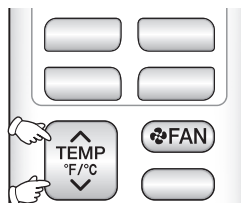

(R21668)

5. Diagnose by the sound.
 - ★ beep: The left-side number does not correspond with the error code.
 - ★ two consecutive beeps: The left-side number corresponds with the error code but the right-side number does not.
 - ★ long beep: Both the left-side and right-side numbers correspond with the error code.
(The numbers indicated when you hear the long beep are the error code.
→ Refer to page 60.)

6. Press the **FAN** button.

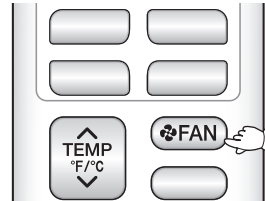

(R21667)

The right-side number blinks.

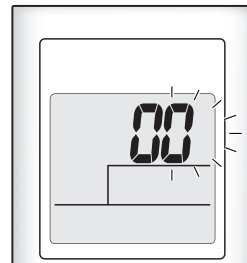

(R21063)

7. Press the **TEMP** \wedge or **TEMP** \vee button and change the number until you hear the long beep.

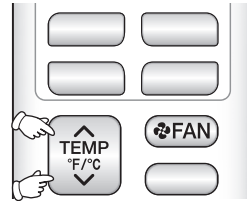

(R21668)

8. Diagnose by the sound.
 - ★ beep: The left-side number does not correspond with the error code.
 - ★ two consecutive beeps: The left-side number corresponds with the error code but the right-side number does not.
 - ★ long beep: Both the left-side and right-side numbers correspond with the error code.

9. Determine the error code.

The numbers indicated when you hear the long beep are the error code.
Error codes and description → Refer to page 60.

10. Press the **FAN** button for 5 seconds to exit from the service check mode.
(When the remote controller is left untouched for 60 seconds, it returns to the normal mode also.)

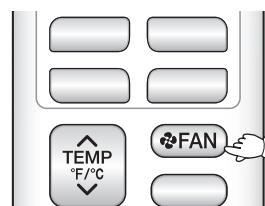

(R21667)

4. Troubleshooting

4.1 Error Codes and Description

	Error Codes	Description	Reference Page
System	00	Normal	—
	U2	Low-voltage detection or over-voltage detection	66
	U4	Signal transmission error (between indoor unit and outdoor unit)	68
	UR	Unspecified voltage (between indoor unit and outdoor unit)	70
Indoor Unit	R1	Indoor unit PCB abnormality	61
	R5	Freeze-up protection control / heating peak-cut control	62
	R6	Fan motor (DC motor) or related abnormality	63
	C4	Indoor heat exchanger thermistor or related abnormality	65
	C9	Room temperature thermistor or related abnormality	65
Outdoor Unit	E1	Outdoor unit PCB abnormality	71
	E5★	OL activation (compressor overload)	72
	E6★	Compressor lock	74
	E7★	DC fan lock	75
	E8	Input overcurrent detection	76
	E9	Four way valve abnormality	77
	F3	Discharge pipe temperature control	79
	F6	High pressure control in cooling	80
	H0	Compressor system sensor abnormality	82
	H6	Position sensor abnormality	83
	H9	Outdoor temperature thermistor or related abnormality	85
	J3★	Discharge pipe thermistor or related abnormality	85
	J6	Outdoor heat exchanger thermistor or related abnormality	85
	L3	Electrical box temperature rise	87
	L4	Radiation fin temperature rise	88
	L5★	Output overcurrent detection	89
	P4	Radiation fin thermistor or related abnormality	85

★: Displayed only when system-down occurs.

4.2 Indoor Unit PCB Abnormality

Error Code	A1
Method of Error Detection	The system checks if the circuit works properly within the microcomputer of the indoor unit.
Error Decision Conditions	The system cannot set the internal settings.
Supposed Causes	<ul style="list-style-type: none"> ■ Wrong models interconnected ■ Defective indoor unit PCB ■ Disconnection of connector ■ Reduction of power supply voltage

Troubleshooting

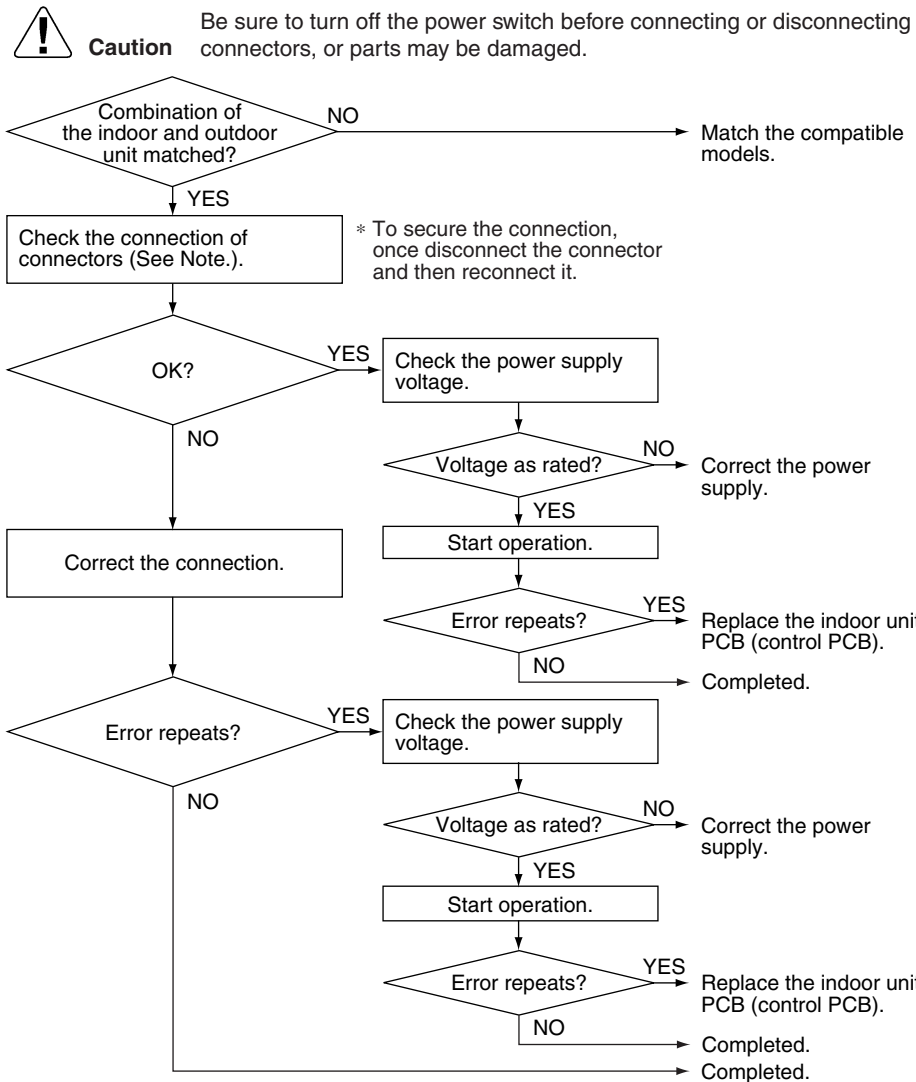

i Note: Check the following connector.

Model Type	Connector
09/12 class	Terminal board ~ Control PCB (H1, H2, H3)
18/24 class	Terminal board ~ Filter PCB (S100)

(R20486)

4.3 Freeze-up Protection Control / Heating Peak-cut Control

Error Code	A5
Method of Error Detection	<ul style="list-style-type: none"> ■ Freeze-up protection control During cooling operation, the freeze-up protection control (operation halt) is activated according to the temperature detected by the indoor heat exchanger thermistor. ■ Heating peak-cut control During heating operation, the temperature detected by the indoor heat exchanger thermistor is used for the heating peak-cut control (operation halt, outdoor fan stop, etc.)
Error Decision Conditions	<ul style="list-style-type: none"> ■ Freeze-up protection control During cooling operation, the indoor heat exchanger temperature is below 0°C (32°F). ■ Heating peak-cut control During heating operation, the indoor heat exchanger temperature is above about 60°C (140°F) (depending on the model).
Supposed Causes	<ul style="list-style-type: none"> ■ Short-circuited air ■ Clogged air filter of the indoor unit ■ Dust accumulation on the indoor heat exchanger ■ Defective indoor heat exchanger thermistor ■ Defective indoor unit PCB

Troubleshooting



Check No.01
Refer to P.91

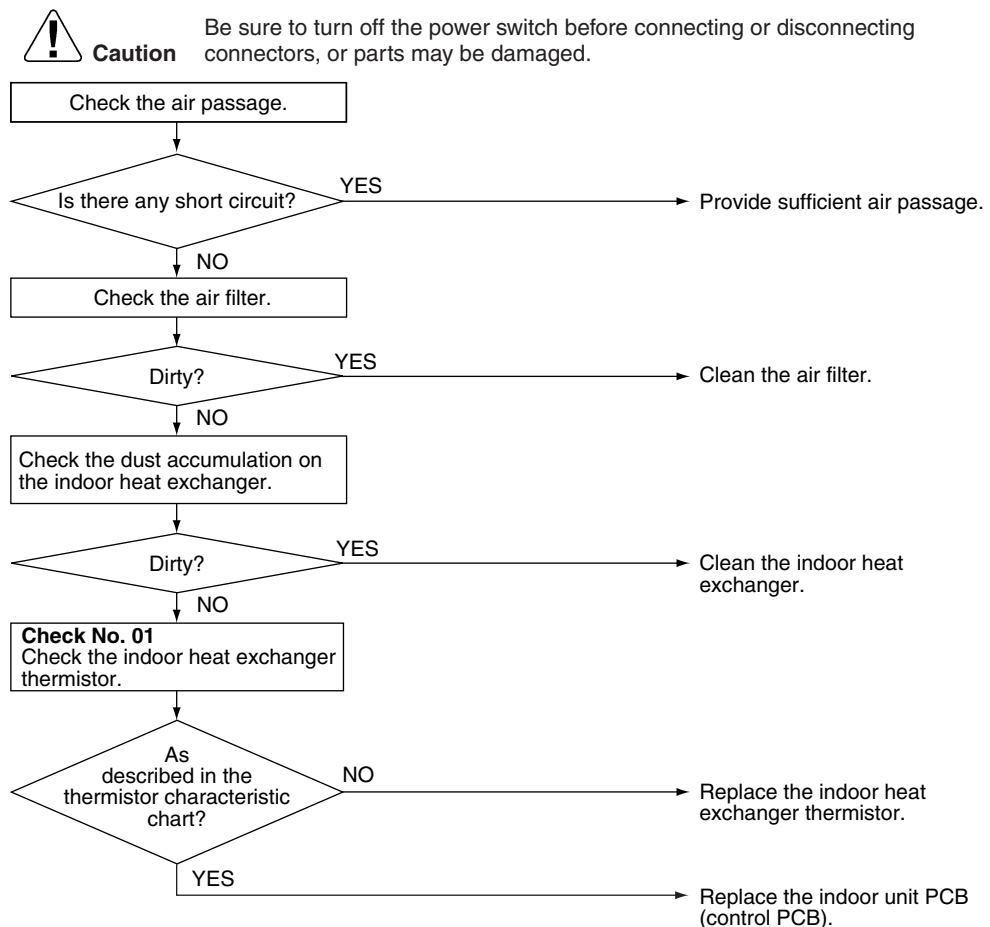

(R21064)

4.4 Fan Motor (DC Motor) or Related Abnormality

Error Code	F6
Method of Error Detection	The rotation speed detected by the Hall IC during fan motor operation is used to determine abnormal fan motor operation.
Error Decision Conditions	The detected rotation speed does not reach the demanded rotation speed of the target tap, and is less than 50% of the maximum fan motor rotation speed.
Supposed Causes	<ul style="list-style-type: none">■ Remarkable decrease in power supply voltage■ Layer short inside the fan motor winding■ Breaking of wire inside the fan motor■ Breaking of the fan motor lead wires■ Defective capacitor of the fan motor■ Defective indoor unit PCB

Troubleshooting

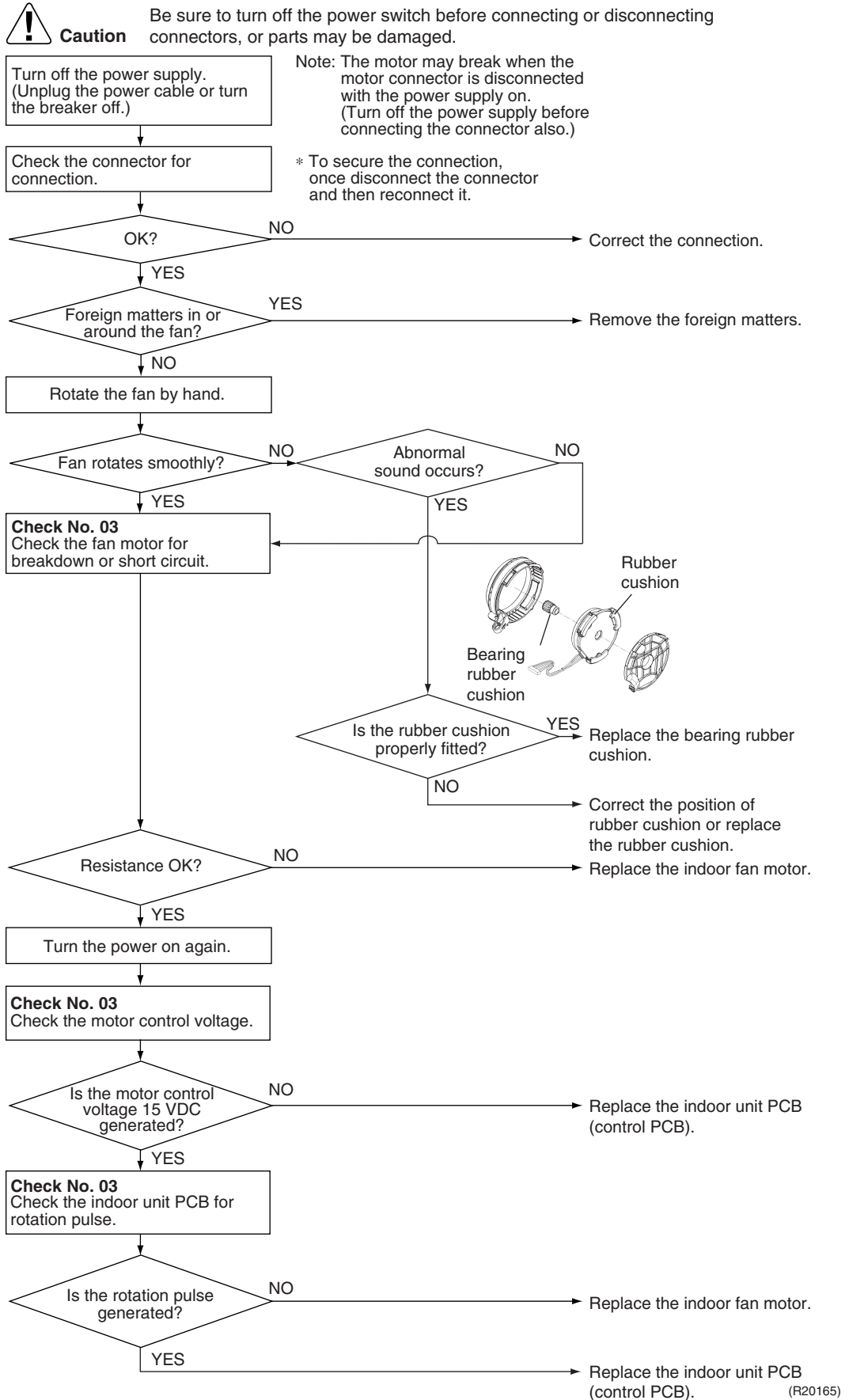

Check No.03
 Refer to P.92



4.5 Thermistor or Related Abnormality (Indoor Unit)

Error Code	£4, £9
Method of Error Detection	The temperatures detected by the thermistors determine thermistor errors.
Error Decision Conditions	The voltage between the both ends of the thermistor is 4.96 V and more or 0.04 V and less during compressor operation.
Supposed Causes	<ul style="list-style-type: none"> ■ Disconnection of connector ■ Thermistor corresponding to the error code is defective. ■ Defective indoor unit PCB

Troubleshooting

 **Check No.01**
Refer to P.91

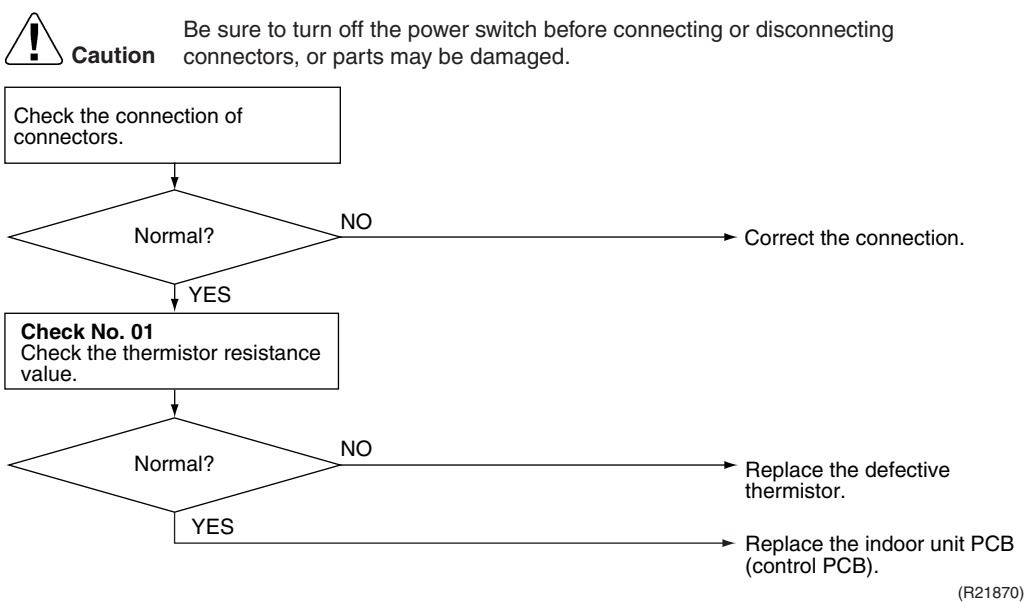

£4 : Indoor heat exchanger thermistor
 £9 : Room temperature thermistor

4.6 Low-voltage Detection or Over-voltage Detection

Error Code	U2
Method of Error Detection	<p>Low-voltage detection: An abnormal voltage drop is detected by the DC voltage detection circuit.</p> <p>Over-voltage detection: An abnormal voltage rise is detected by the over-voltage detection circuit.</p>
Error Decision Conditions	<p>Low-voltage detection:</p> <ul style="list-style-type: none"> ■ The voltage detected by the DC voltage detection circuit is below 180 ~ 196 V (depending on the model). ■ The compressor stops if the error occurs, and restarts automatically after 3-minute standby. <p>Over-voltage detection:</p> <ul style="list-style-type: none"> ■ An over-voltage signal is fed from the over-voltage detection circuit to the microcomputer (over 458 ~ 500 V, depending on the model). ■ The compressor stops if the error occurs, and restarts automatically after 3-minute standby.
Supposed Causes	<ul style="list-style-type: none"> ■ Power supply voltage is not as specified. ■ Defective DC voltage detection circuit ■ Defective over-voltage detection circuit ■ Defective PAM control part ■ Disconnection of compressor harness ■ Short circuit inside the fan motor winding ■ Noise ■ Momentary drop of voltage ■ Momentary power failure ■ Defective outdoor unit PCB

Troubleshooting



Caution Be sure to turn off the power switch before connecting or disconnecting connectors, or parts may be damaged.

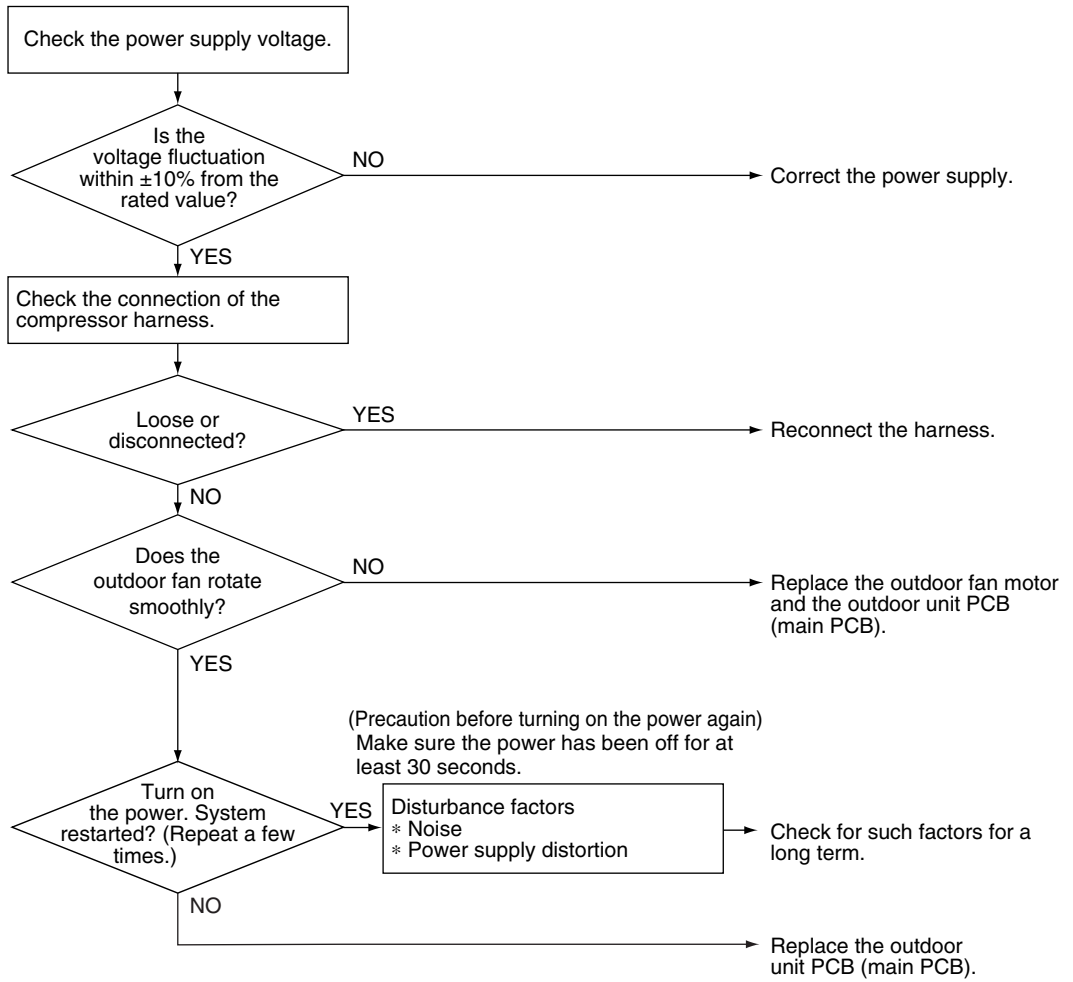

(R21191)

4.7 Signal Transmission Error (between Indoor Unit and Outdoor Unit)

Error Code	U4
Method of Error Detection	The data received from the outdoor unit in signal transmission is checked whether it is normal.
Error Decision Conditions	The data sent from the outdoor unit cannot be received normally, or the content of the data is abnormal.
Supposed Causes	<ul style="list-style-type: none">■ Power supply voltage is not as specified.■ Reduction of power supply voltage■ Wiring error■ Breaking of the connecting wires between the indoor and outdoor units (wire No. 3)■ Defective outdoor unit PCB■ Short circuit inside the fan motor winding■ Defective indoor unit PCB■ Disturbed power supply waveform

Troubleshooting



Check No.11
Refer to P.93



Caution

Be sure to turn off the power switch before connecting or disconnecting connectors, or parts may be damaged.

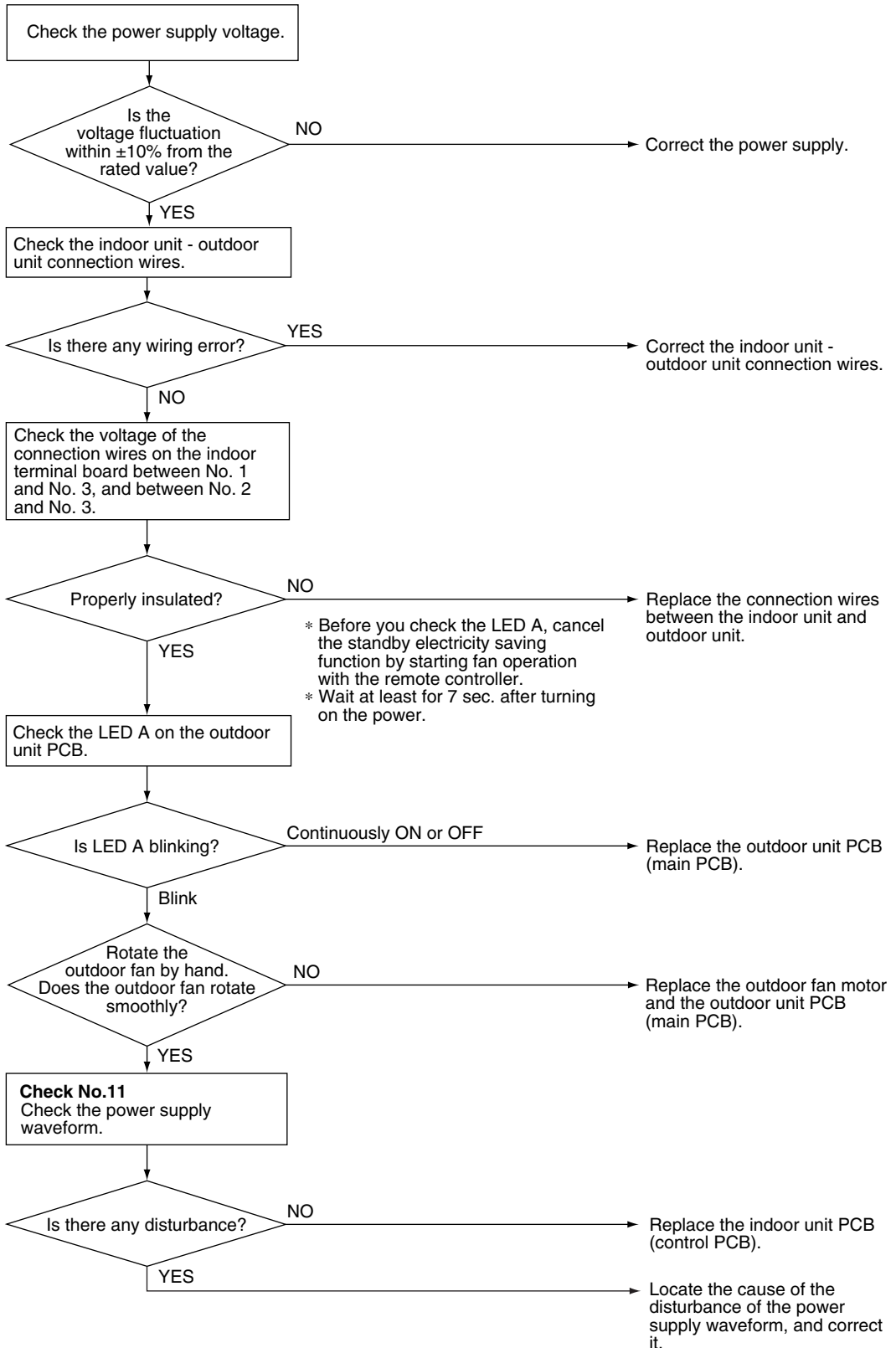

(R21189)

4.8 Unspecified Voltage (Between Indoor Unit and Outdoor Unit)

Error Code	UR
Method of Error Detection	The supply power is detected for its requirements (pair type is different from multi type) by the indoor / outdoor transmission signal.
Error Decision Conditions	The pair type and multi type are interconnected.
Supposed Causes	<ul style="list-style-type: none"> ■ Wrong models interconnected ■ Wrong wiring of connecting wires ■ Wrong indoor unit PCB or outdoor unit PCB mounted ■ Defective indoor unit PCB ■ Defective outdoor unit PCB

Troubleshooting

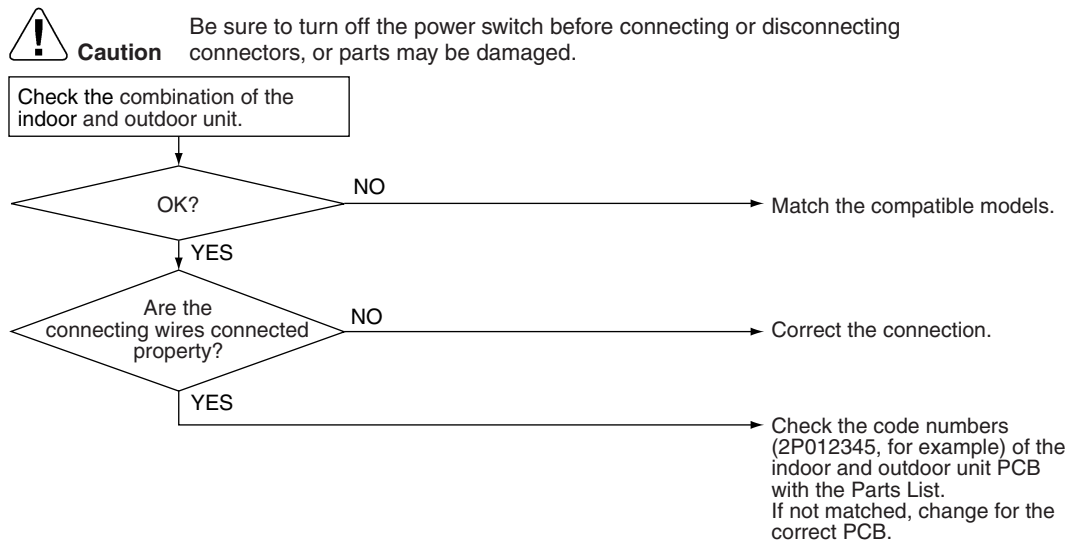

(R20435)

4.9 Outdoor Unit PCB Abnormality

Error Code	E1
Method of Error Detection	<ul style="list-style-type: none"> ■ The system checks if the microprocessor is working in order. ■ The system checks if the zero-cross signal comes in properly.
Error Decision Conditions	<ul style="list-style-type: none"> ■ The microprocessor program runs out of control. ■ The zero-cross signal is not detected.
Supposed Causes	<ul style="list-style-type: none"> ■ Defective outdoor unit PCB ■ Noise ■ Momentary drop of voltage ■ Momentary power failure

Troubleshooting

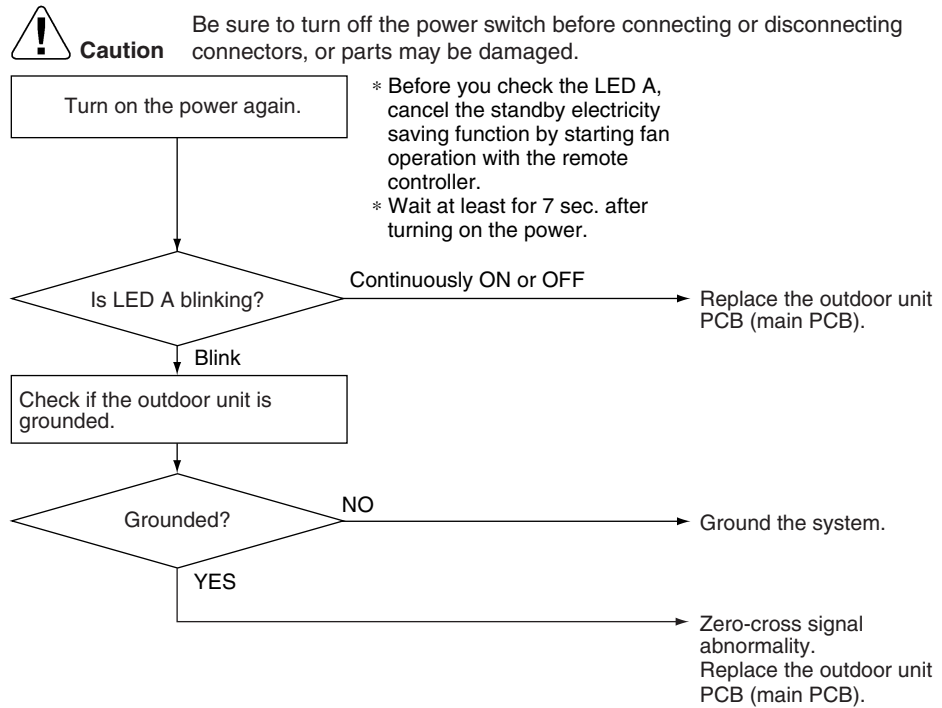

(R21201)

4.10 OL Activation (Compressor Overload)

Error Code	E5
Method of Error Detection	A compressor overload is detected through compressor OL.
Error Decision Conditions	<ul style="list-style-type: none">■ If the error repeats, the system is shut down.■ Reset condition: Continuous run for about 60 minutes without any other error
Supposed Causes	<ul style="list-style-type: none">■ Disconnection of discharge pipe thermistor■ Defective discharge pipe thermistor■ Disconnection of connector S40■ Disconnection of 2 terminals of OL (Q1L)■ Defective OL (Q1L)■ Broken OL harness■ Defective electronic expansion valve or coil■ Defective four way valve or coil■ Defective outdoor unit PCB■ Refrigerant shortage■ Water mixed in refrigerant■ Defective stop valve

Troubleshooting

Check No.01
 Refer to P.91



Check No.12
 Refer to P.93

Check No.13
 Refer to P.94

Check No.14
 Refer to P.94

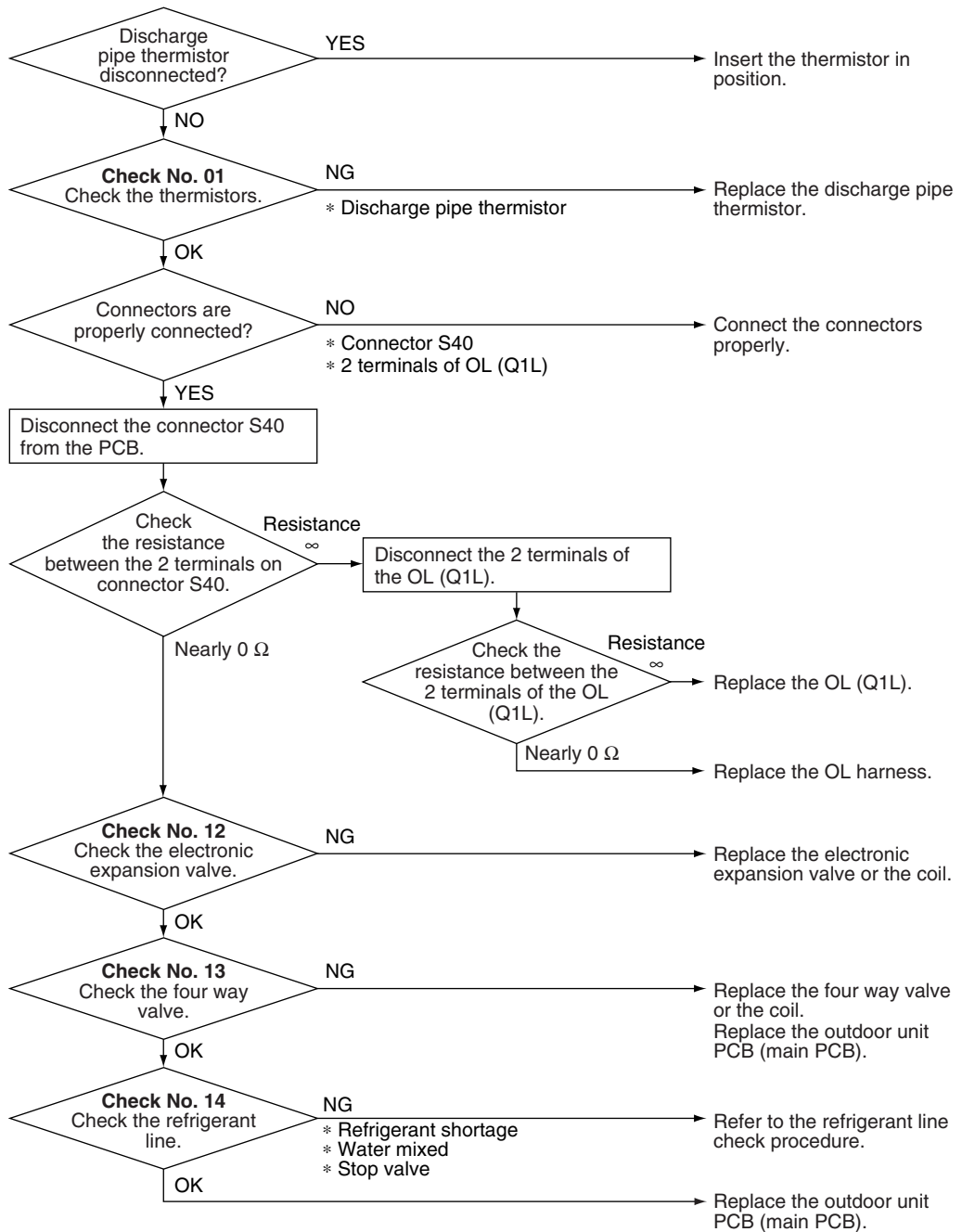

Caution Be sure to turn off the power switch before connecting or disconnecting connectors, or parts may be damaged.



Note: OL (Q1L) activating temperature: 130°C (266°F)
 OL (Q1L) recovery temperature: 95°C (203°F)

4.11 Compressor Lock

Error Code

EE

Method of Error Detection

A compressor lock is detected by the current waveform generated when applying high-frequency voltage to the motor.

Error Decision Conditions

- If the error repeats, the system is shut down.
- Reset condition: Continuous run for about 11 minutes without any other error

Supposed Causes

- Closed stop valve
- Compressor locked
- Disconnection of compressor harness

Troubleshooting



Check No.12
Refer to P.93



Check No.15
Refer to P.95



Caution

Be sure to turn off the power switch before connecting or disconnecting connectors, or parts may be damaged.

(Precaution before turning on the power again)

Make sure the power has been off for at least 30 seconds.

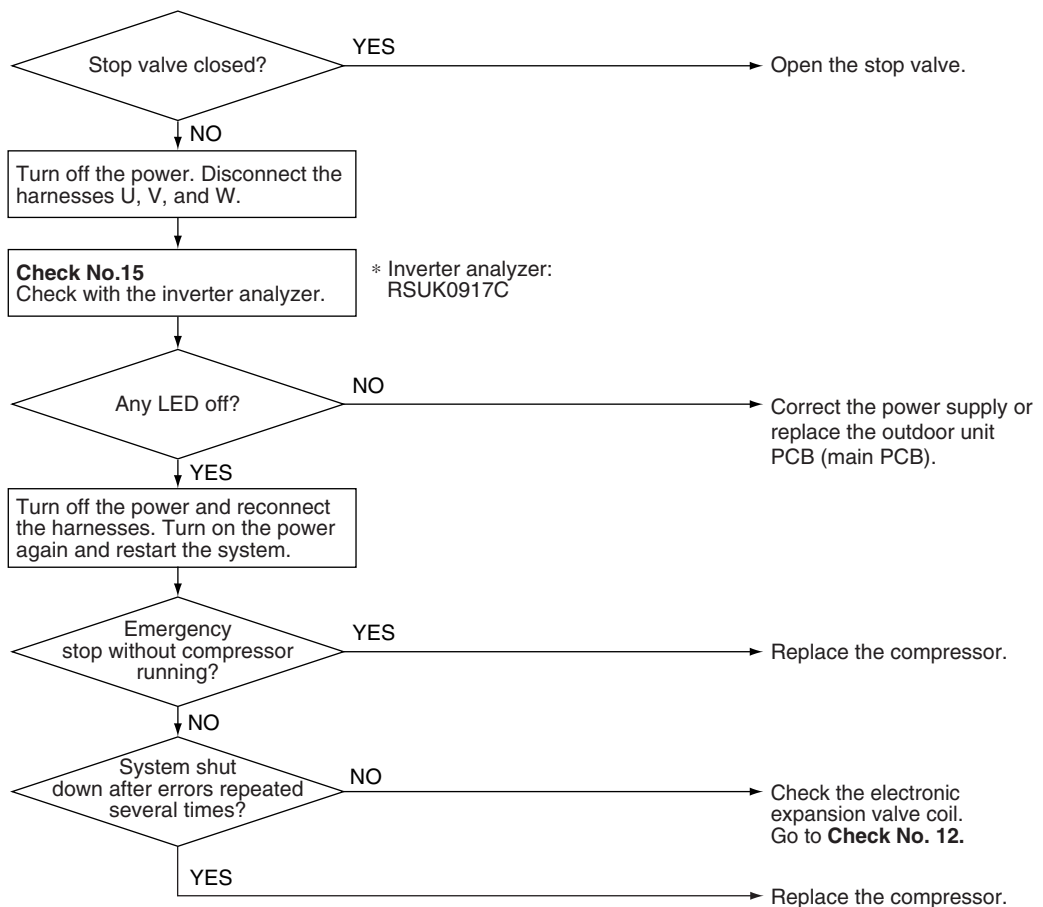

(R21067)

4.12 DC Fan Lock

Error Code	E7
Method of Error Detection	An error is determined with the high-voltage fan motor rotation speed detected by the Hall IC.
Error Decision Conditions	<ul style="list-style-type: none"> ■ The fan does not start in 15 ~ 30 seconds even when the fan motor is running. ■ If the error repeats, the system is shut down. ■ Reset condition: Continuous run for about 11 minutes without any other error
Supposed Causes	<ul style="list-style-type: none"> ■ Disconnection of the fan motor ■ Foreign matter stuck in the fan ■ Defective fan motor ■ Defective outdoor unit PCB

Troubleshooting

Check No.16
 Refer to P.97

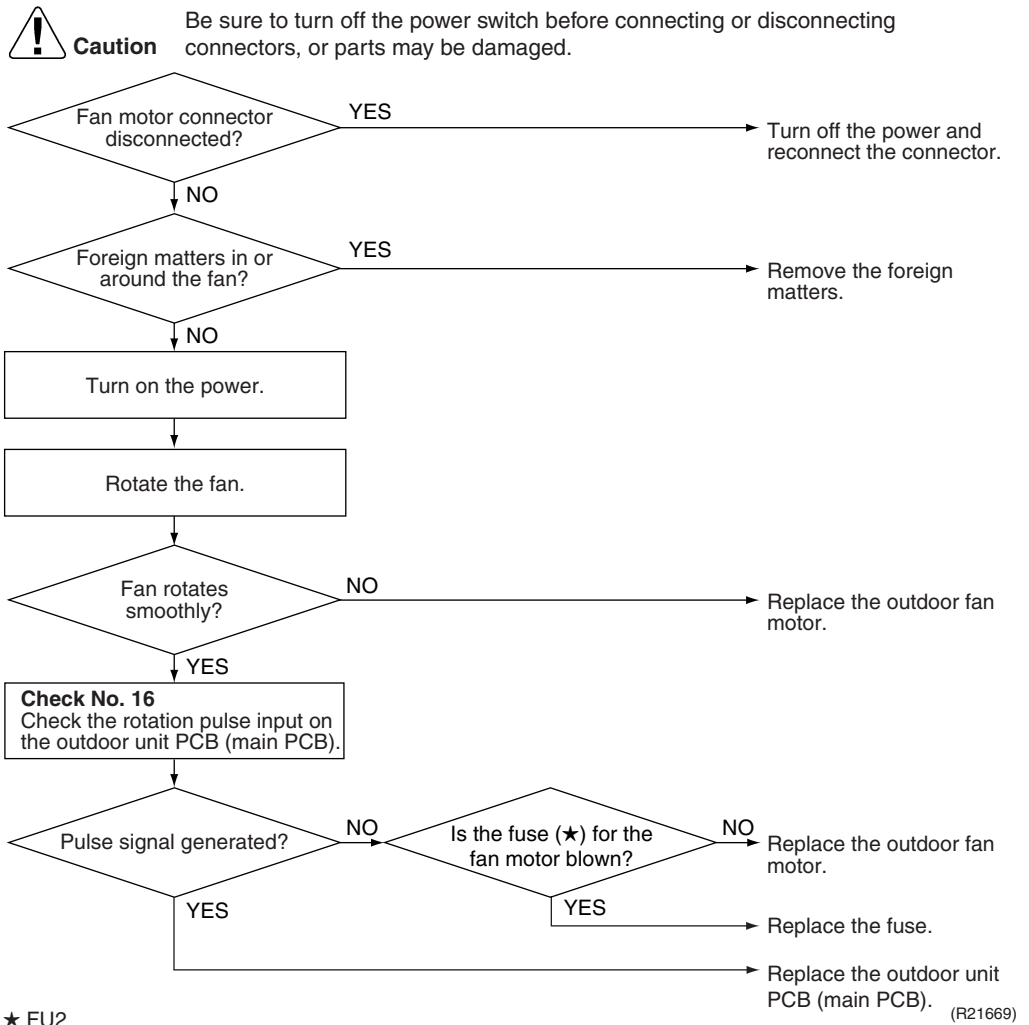

4.13 Input Overcurrent Detection

Error Code	E8
Method of Error Detection	An input overcurrent is detected by checking the input current value with the compressor running.
Error Decision Conditions	The current exceeds about 7.75 ~ 18.0 A (depending on the model and operation mode) for 2.5 seconds with the compressor running. (The upper limit of the current decreases when the outdoor temperature exceeds a certain level.)
Supposed Causes	<ul style="list-style-type: none"> ■ Outdoor temperature is out of operation range. ■ Defective compressor ■ Defective power module ■ Defective outdoor unit PCB ■ Short circuit

Troubleshooting

Check No.15
 Refer to P.95



Check No.17
 Refer to P.98

Check No.18
 Refer to P.98

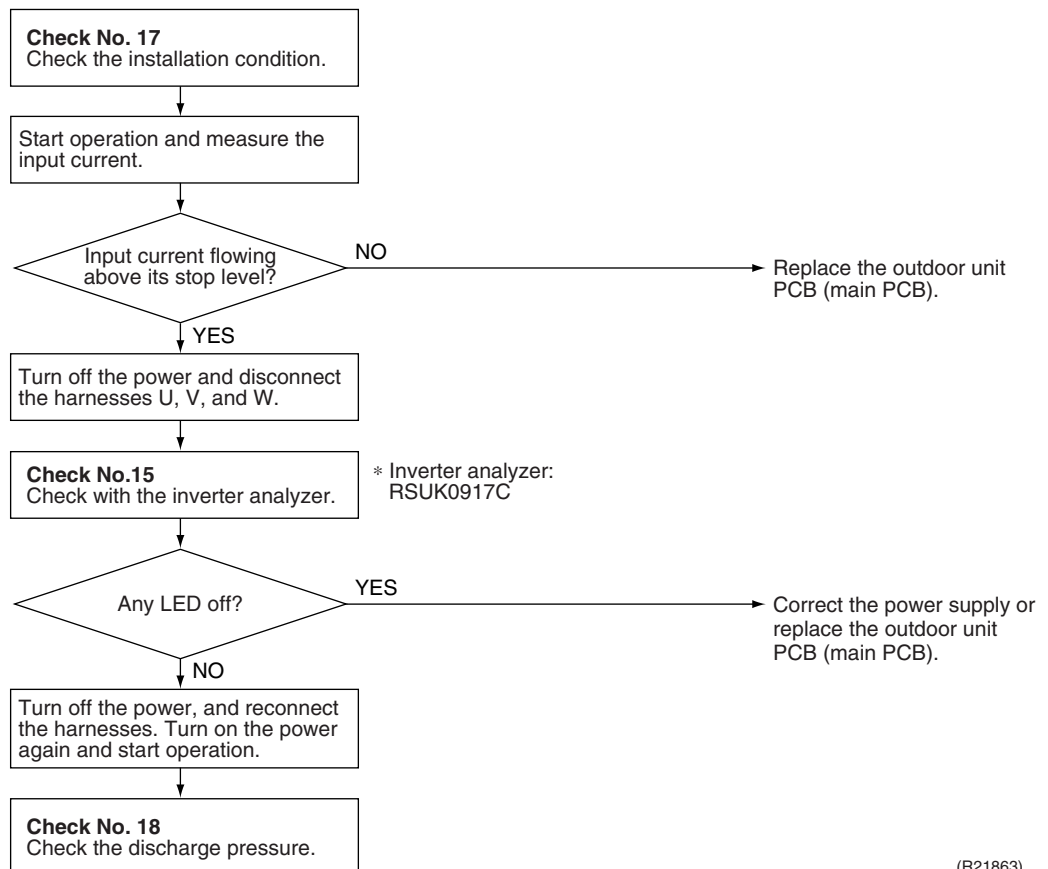

Caution Be sure to turn off the power switch before connecting or disconnecting connectors, or parts may be damaged.

* An input overcurrent may result from wrong internal wiring. If the system is interrupted by an input overcurrent after the wires have been disconnected and reconnected for part replacement, check the wiring again.



(R21863)

4.14 Four Way Valve Abnormality

Error Code	E8
Method of Error Detection	The room temperature thermistor and the indoor heat exchanger thermistor are checked if they function within their normal ranges in each operation mode.
Error Decision Conditions	<p>A following condition continues over 10 minutes after operating for 5 minutes.</p> <ul style="list-style-type: none"> ■ Cooling / Dry <ul style="list-style-type: none"> A – B < –5°C (A – B < –9°F) ■ Heating <ul style="list-style-type: none"> B – A < –5°C (B – A < –9°F) <p style="margin-left: 40px;">A: Room thermistor temperature B: Indoor heat exchanger temperature</p> <ul style="list-style-type: none"> ■ If the error repeats, the system is shut down. ■ Reset condition: Continuous run for about 60 minutes without any other error
Supposed Causes	<ul style="list-style-type: none"> ■ Disconnection of four way valve coil ■ Defective four way valve, coil, or harness ■ Defective outdoor unit PCB ■ Defective thermistor ■ Refrigerant shortage ■ Water mixed in refrigerant ■ Defective stop valve

Troubleshooting



Check No.01
Refer to P.91



Check No.13
Refer to P.94



Check No.14
Refer to P.94



Caution Be sure to turn off the power switch before connecting or disconnecting connectors, or parts may be damaged.

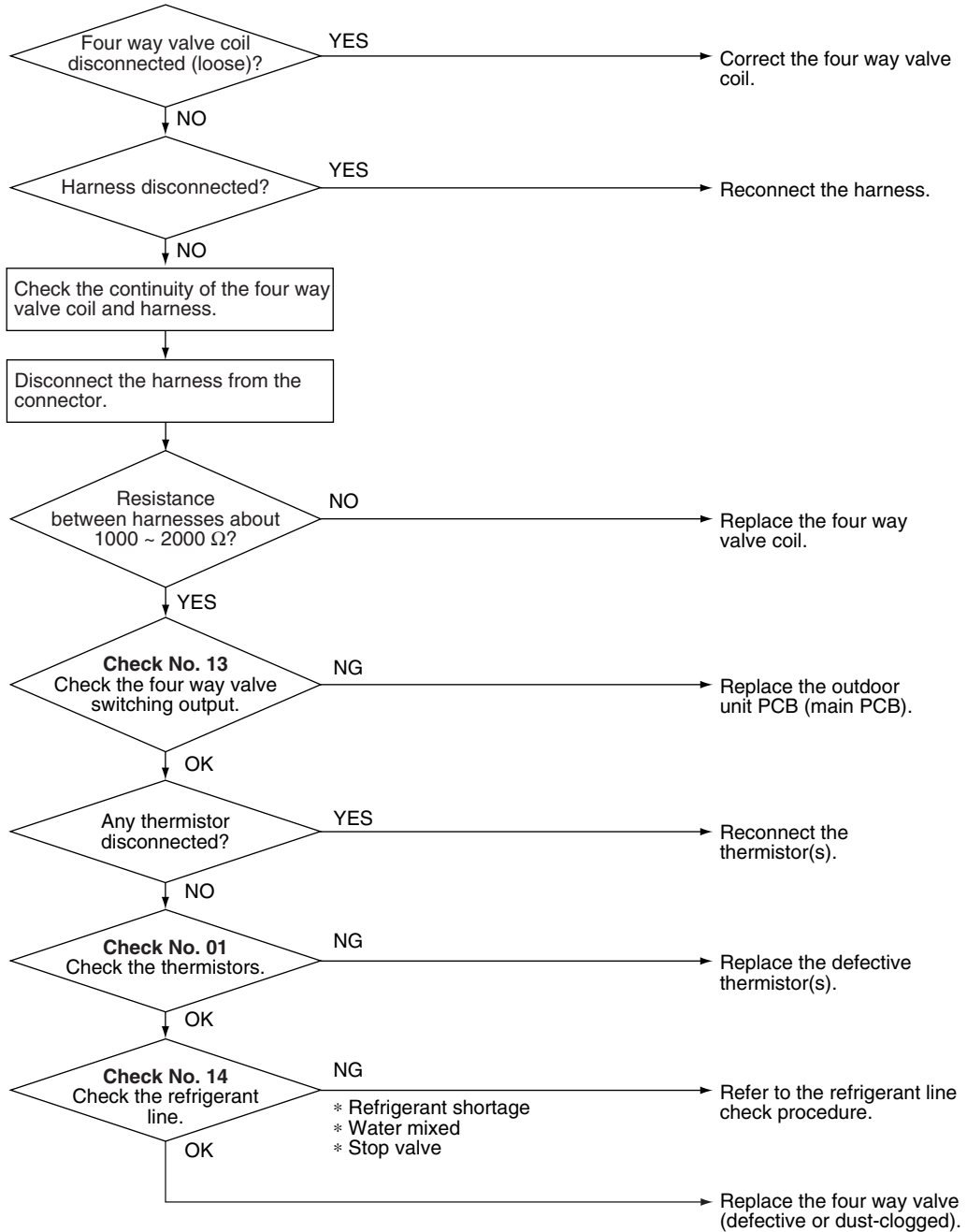

(R20405)

4.15 Discharge Pipe Temperature Control

Error Code F3

Method of Error Detection An error is determined with the temperature detected by the discharge pipe thermistor.

Error Decision Conditions

- If the temperature detected by the discharge pipe thermistor rises above **A**, the compressor stops.
- The error is cleared when the discharge pipe temperature has dropped below **B**.

09/12 class, RKN18NMVJU

A		B	
°C	°F	°C	°F
110	230	88	190.4

★ If the frequency drops, the temperature is lowered in compensation.

RXN18NMVJU, RK(X)18NMVJU, 24 class

A		B	
°C	°F	°C	°F
110	230	95	203

- If the error repeats, the system is shut down.
- Reset condition: Continuous run for about 60 minutes without any other error

Supposed Causes

- Defective discharge pipe thermistor (Defective outdoor heat exchanger thermistor or outdoor temperature thermistor)
- Defective electronic expansion valve or coil
- Refrigerant shortage
- Defective four way valve
- Water mixed in refrigerant
- Defective stop valve
- Defective outdoor unit PCB

Troubleshooting

- 

Check No.01
Refer to P.91
- 

Check No.12
Refer to P.93
- 

Check No.14
Refer to P.94

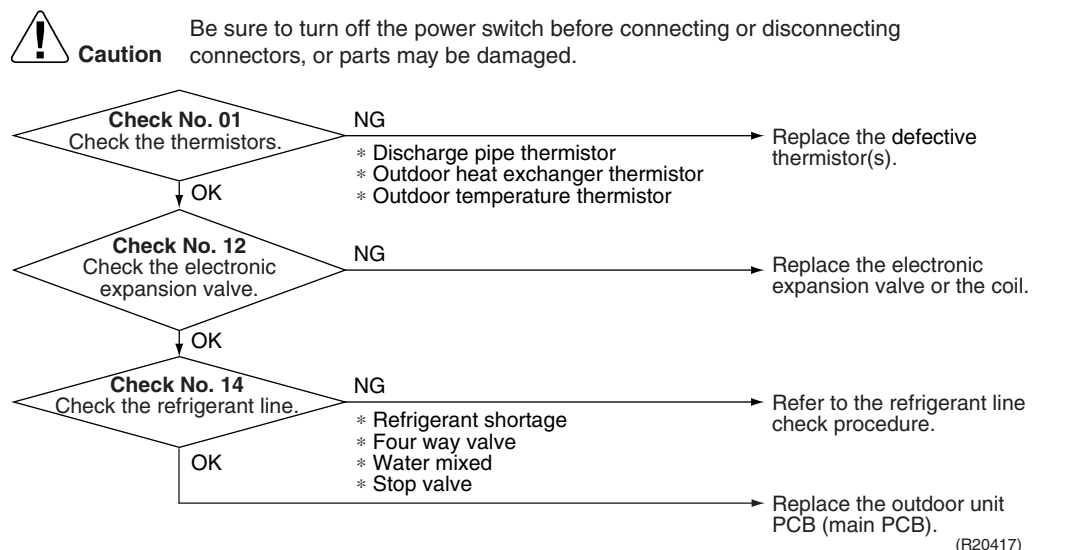

4.16 High Pressure Control in Cooling

Error Code	F6
Method of Error Detection	High-pressure control (operation halt, frequency drop, etc.) is activated in cooling operation if the temperature sensed by the outdoor heat exchanger thermistor exceeds the limit.
Error Decision Conditions	<ul style="list-style-type: none">■ The temperature sensed by the outdoor heat exchanger thermistor rise above 59 ~ 62°C (138.2 ~ 143.6°F) (depending on the model).■ The error is cleared when the temperature drops below 51 ~ 53°C (123.8 ~ 127.4°F) (depending on the model).
Supposed Causes	<ul style="list-style-type: none">■ The installation space is not large enough.■ Dirty outdoor heat exchanger■ Defective outdoor fan motor■ Defective stop valve■ Defective electronic expansion valve or coil■ Defective outdoor heat exchanger thermistor■ Defective outdoor unit PCB

Troubleshooting



Check No.01
Refer to P.91



Check No.12
Refer to P.93



Check No.17
Refer to P.98



Check No.18
Refer to P.98



Check No.19
Refer to P.99



Caution

Be sure to turn off the power switch before connecting or disconnecting connectors, or parts may be damaged.

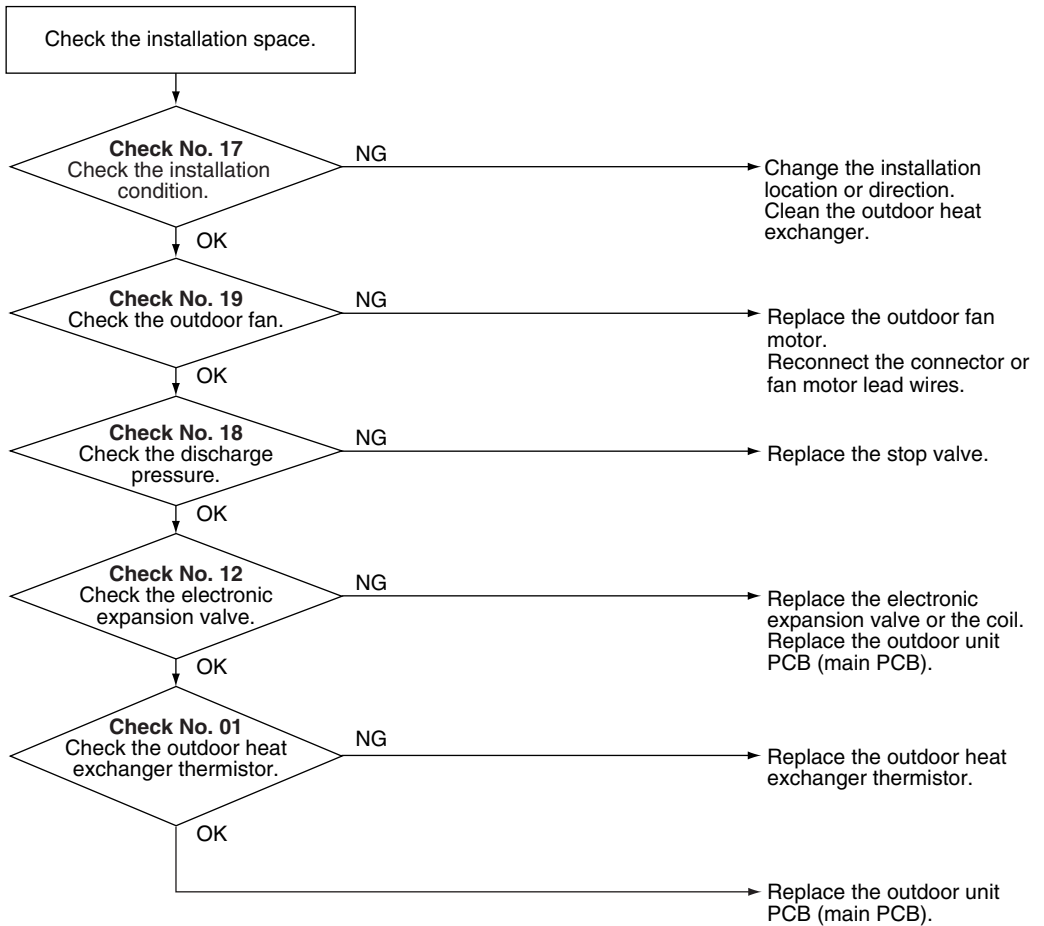

(R20418)

4.17 Compressor System Sensor Abnormality

Error Code	H0
Method of Error Detection	The system checks the DC current before the compressor starts.
Error Decision Conditions	<ul style="list-style-type: none"> ■ The voltage converted from the DC current before compressor start-up is out of the range 0.5 ~ 4.5 V. ■ The DC voltage before compressor start-up is below 50 V.
Supposed Causes	<ul style="list-style-type: none"> ■ Broken or disconnected harness ■ Defective outdoor unit PCB

Troubleshooting

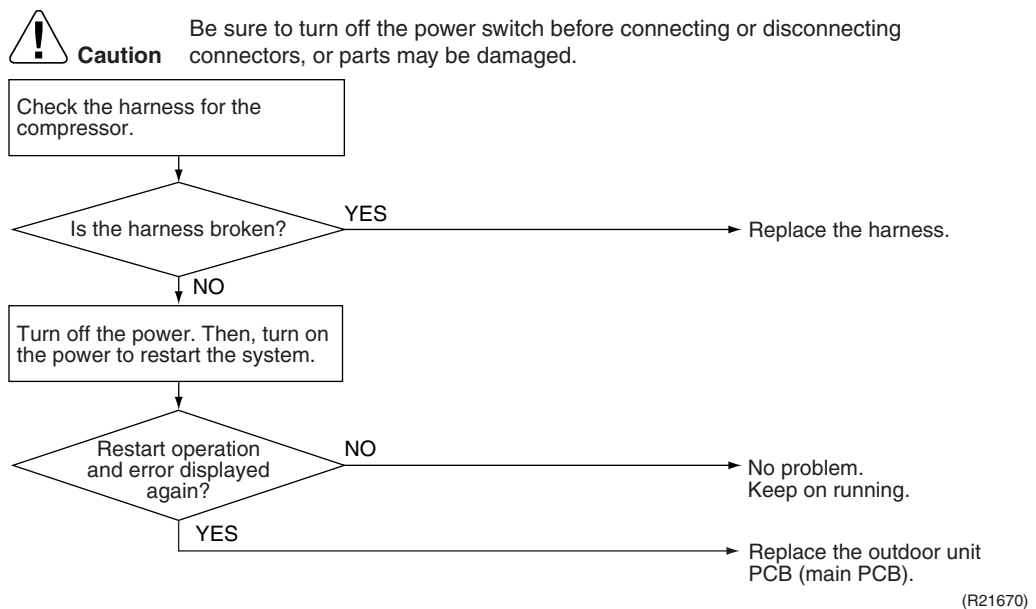

4.18 Position Sensor Abnormality

Error Code	H6
Method of Error Detection	A compressor start-up failure is detected by checking the compressor running condition through the position detection circuit.
Error Decision Conditions	<ul style="list-style-type: none">■ If the error repeats, the system is shut down.■ Reset condition: Continuous run for about 11 minutes without any other error
Supposed Causes	<ul style="list-style-type: none">■ Power supply voltage is not as specified.■ Disconnection of the compressor harness■ Defective compressor■ Defective outdoor unit PCB■ Start-up failure caused by the closed stop valve■ Input voltage is outside the specified range.

Troubleshooting



Check No.15
Refer to P.95



Check No.18
Refer to P.98



Check No.20
Refer to P.99



Caution Be sure to turn off the power switch before connecting or disconnecting connectors, or parts may be damaged.

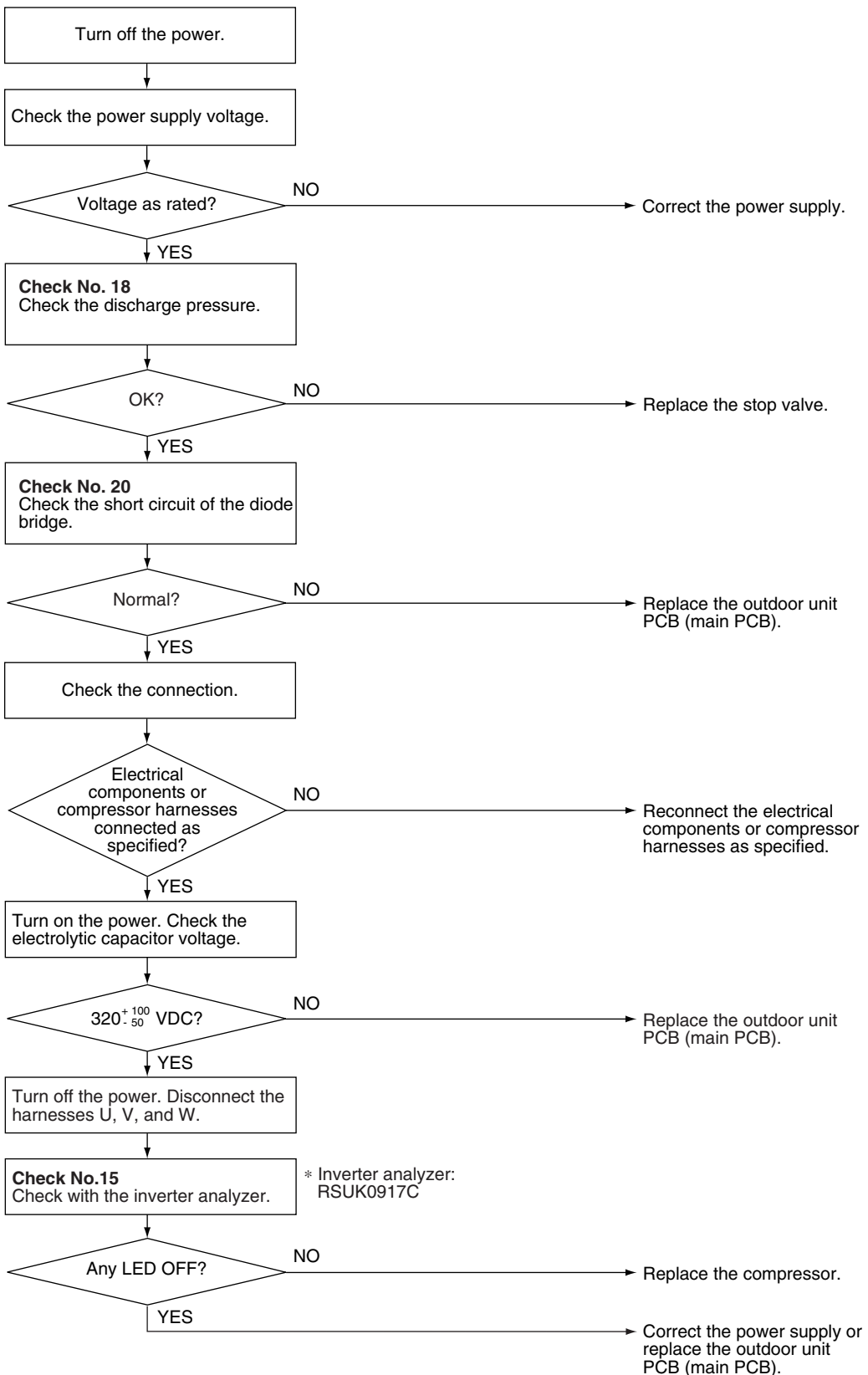

(R21864)

4.19 Thermistor or Related Abnormality (Outdoor Unit)

Error Code	<i>H3, U3, U5, P4</i>
Method of Error Detection	This fault is identified based on the thermistor input voltage to the microcomputer. A thermistor fault is identified based on the temperature sensed by each thermistor.
Error Decision Conditions	<ul style="list-style-type: none"> ■ The voltage between the both ends of the thermistor is above 4.96 V or below 0.04 V with the power on. ■ <i>U3</i> error is judged if the discharge pipe temperature is lower than the heat exchanger temperature.
Supposed Causes	<ul style="list-style-type: none"> ■ Disconnection of the connector for the thermistor ■ Thermistor corresponding to the error code is defective. ■ Defective heat exchanger thermistor in the case of <i>U3</i> error (outdoor heat exchanger thermistor in cooling operation, or indoor heat exchanger thermistor in heating operation) ■ Defective outdoor unit PCB
Troubleshooting	<p>In case of <i>P4</i></p> <p> Caution Be sure to turn off the power switch before connecting or disconnecting connectors, or parts may be damaged.</p> <p>Replace the outdoor unit PCB (main PCB).</p> <p><i>P4</i> : Radiation fin thermistor</p>

Troubleshooting



Check No.01
Refer to P.91

In case of *H3*, *J3*, *J5*



Caution

Be sure to turn off the power switch before connecting or disconnecting connectors, or parts may be damaged.

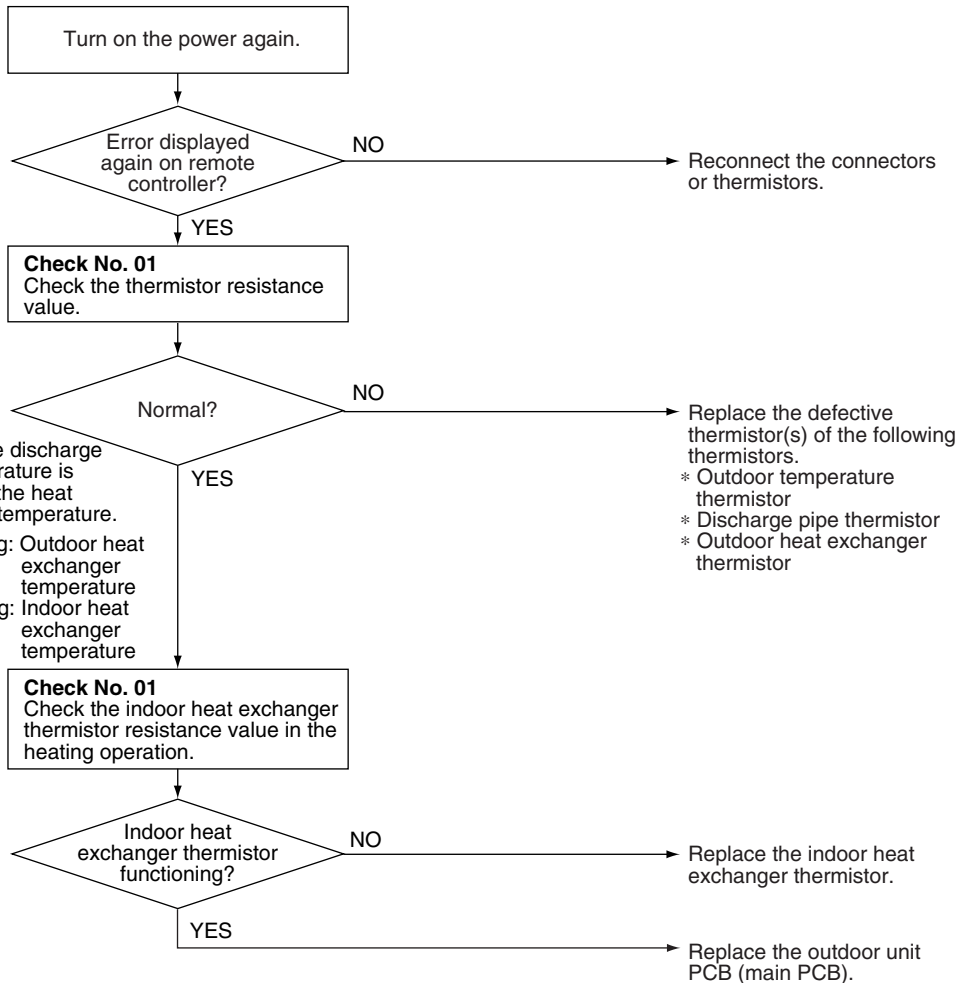

J3 error: the discharge pipe temperature is lower than the heat exchanger temperature.

Cooling: Outdoor heat exchanger temperature
Heating: Indoor heat exchanger temperature

(R20406)

- H3* : Outdoor temperature thermistor
- J3* : Discharge pipe thermistor
- J5* : Outdoor heat exchanger thermistor

4.20 Electrical Box Temperature Rise

Error Code U3

Method of Error Detection An electrical box temperature rise is detected by checking the radiation fin thermistor with the compressor off.

Error Decision Conditions

- With the compressor off, the radiation fin temperature is above **A**.
- The error is cleared when the radiation fin temperature drops below **B**.
- To cool the electrical components, the outdoor fan starts when the radiation fin temperature rises above **C** and stops when it drops below **B**.

	A		B		C	
	°C	°F	°C	°F	°C	°F
09/12 class, RKN18NMVJU	82	179.6	65	149	70	158
RXN18NMVJU, RK(X)18NMVJU, 24 class	90	194	64	147.2	81	177.8

Supposed Causes

- Defective outdoor fan motor
- Short circuit
- Defective radiation fin thermistor
- Disconnection of connector
- Defective outdoor unit PCB

Troubleshooting

 **Check No.17**
Refer to P.98

 **Check No.19**
Refer to P.99

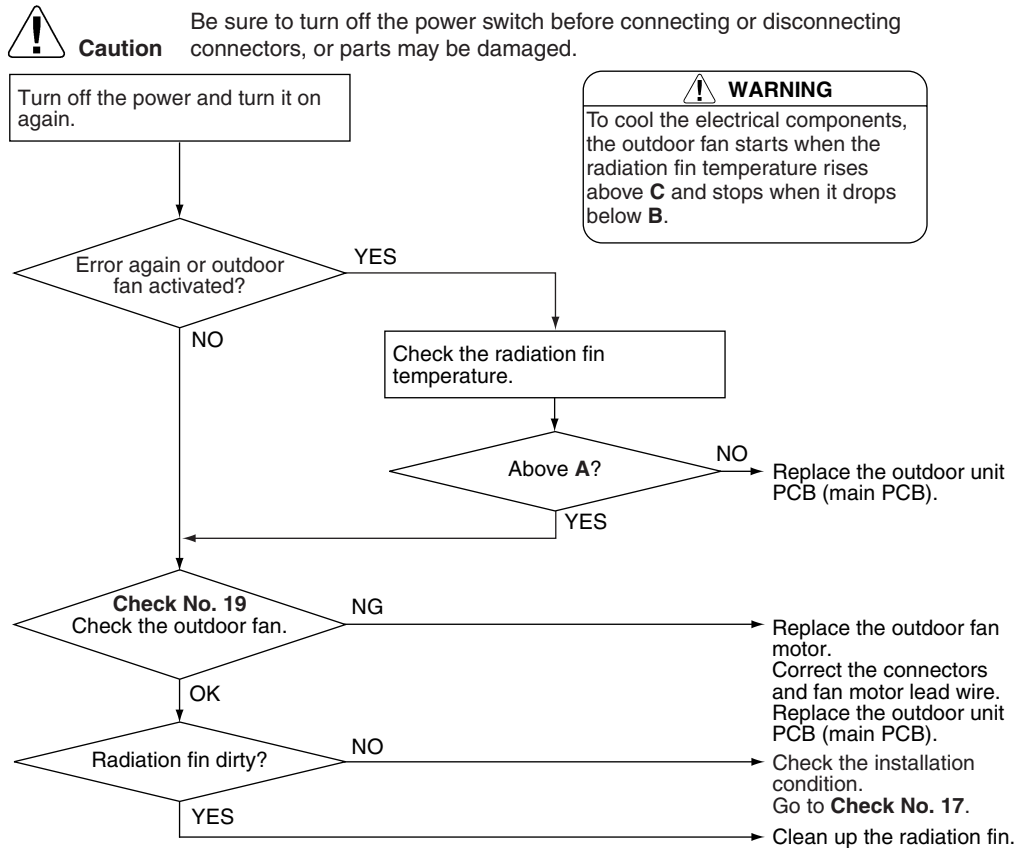

(R21671)

4.21 Radiation Fin Temperature Rise

Error Code L4

Method of Error Detection A radiation fin temperature rise is detected by checking the radiation fin thermistor with the compressor on.

- Error Decision Conditions**
- If the radiation fin temperature with the compressor on is above **A**.
 - The error is cleared when the radiation fin temperature drops below **B**.
 - If the error repeats, the system is shut down.
 - Reset condition: Continuous run for about 60 minutes without any other error

	A		B	
	°C	°F	°C	°F
09/12 class, RKN18NMVJU	99	210.2	70	158
RXN18NMVJU, RK(X)18NMVJU, 24 class	100	212	57	134.6

- Supposed Causes**
- Defective outdoor fan motor
 - Short circuit
 - Defective radiation fin thermistor
 - Disconnection of connector
 - Defective outdoor unit PCB
 - Silicon grease is not applied properly on the radiation fin after replacing the outdoor unit PCB.

Troubleshooting

 **Check No.17**
Refer to P.98

 **Check No.19**
Refer to P.99

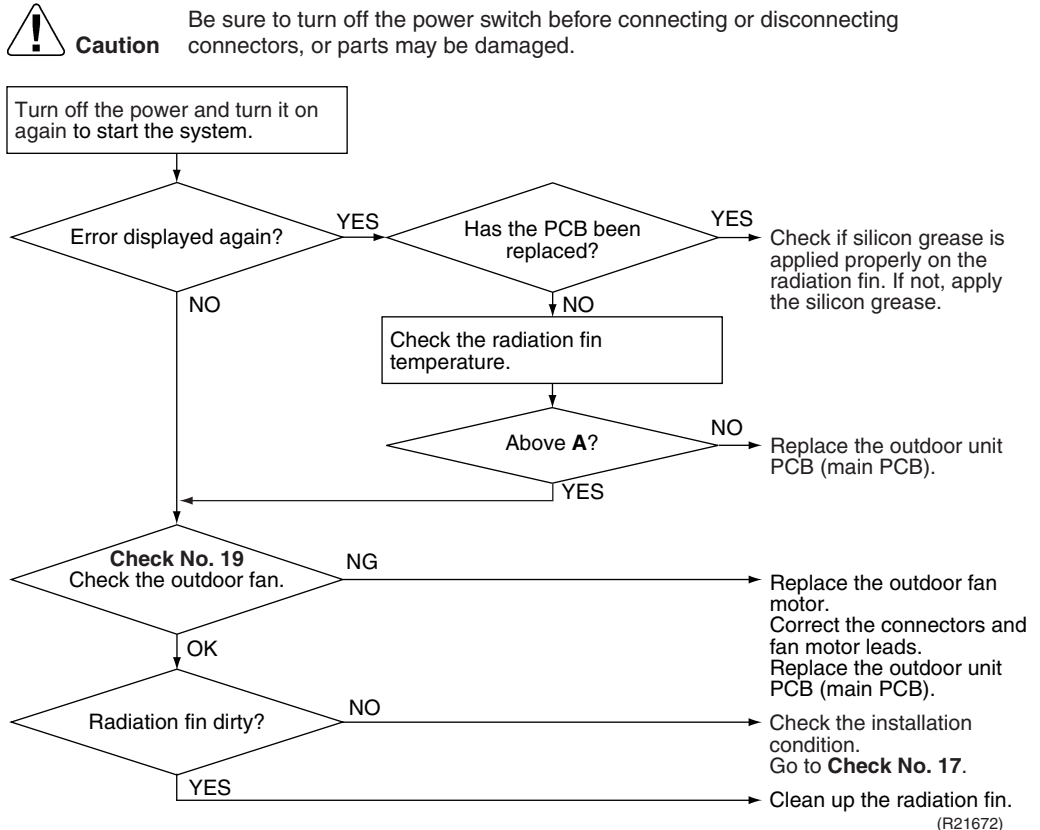

 **Note:** Refer to Silicon Grease on Power Transistor / Diode Bridge on page 108 for detail.

4.22 Output Overcurrent Detection

Error Code	U5
Method of Error Detection	An output overcurrent is detected by checking the current that flows in the inverter DC section.
Error Decision Conditions	<ul style="list-style-type: none">■ A position signal error occurs while the compressor is running.■ A rotation speed error occurs while the compressor is running.■ An output overcurrent signal is fed from the output overcurrent detection circuit to the microcomputer.■ If the error repeats, the system is shut down.■ Reset condition: Continuous run for about 11 minutes without any other error
Supposed Causes	<ul style="list-style-type: none">■ Poor installation condition■ Closed stop valve■ Defective power module■ Wrong internal wiring■ Abnormal power supply voltage■ Defective outdoor unit PCB■ Power supply voltage is not as specified.■ Defective compressor

Troubleshooting



Check No.15
Refer to P.95



Check No.17
Refer to P.98



Check No.18
Refer to P.98



Check No.22
Refer to P.100



Caution Be sure to turn off the power switch before connecting or disconnecting connectors, or parts may be damaged.

* An output overcurrent may result from wrong internal wiring. If the system is interrupted by an output overcurrent after the wires have been disconnected and reconnected for part replacement, check the wiring again.

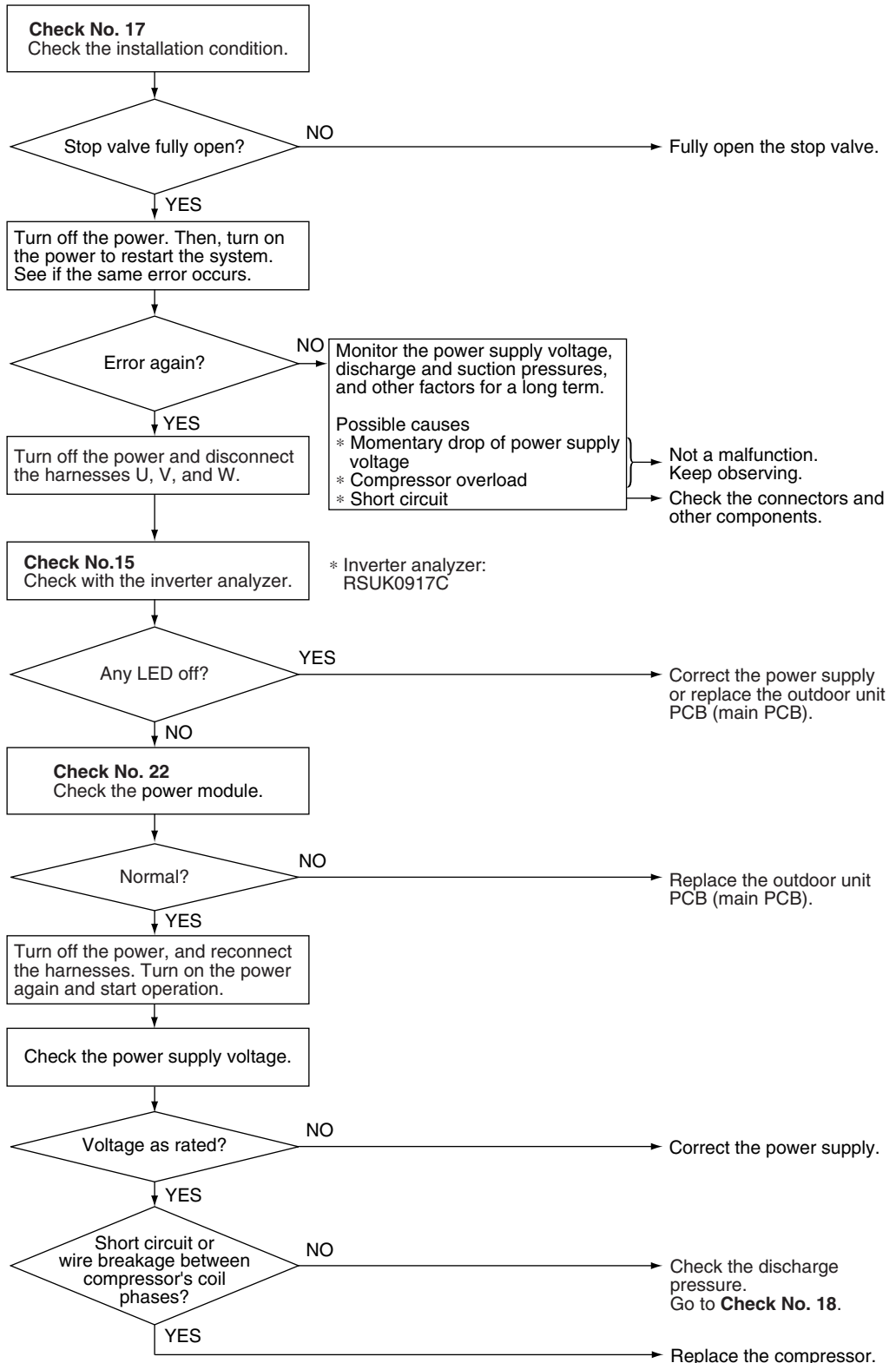

(R21438)

5. Check

5.1 Thermistor Resistance Check

Check No.01

Disconnect the connectors of the thermistors from the PCB, and measure the resistance of each thermistor using multimeter.

Thermistor temperature		Resistance (kΩ)	
°C	°F	Room temperature thermistor	Other thermistors
-20	-4	73.4	197.8
-15	5	57.0	148.2
-10	14	44.7	112.1
-5	23	35.3	85.60
0	32	28.2	65.93
5	41	22.6	51.14
10	50	18.3	39.99
15	59	14.8	31.52
20	68	12.1	25.02
25	77	10.0	20.00
30	86	8.2	16.10
35	95	6.9	13.04
40	104	5.8	10.62
45	113	4.9	8.707
50	122	4.1	7.176

(R25°C (77°F) = 10 kΩ, B = 3435 K) (R25°C (77°F) = 20 kΩ, B = 3950 K)

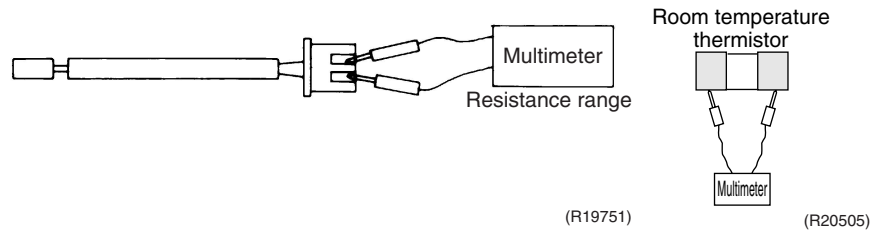
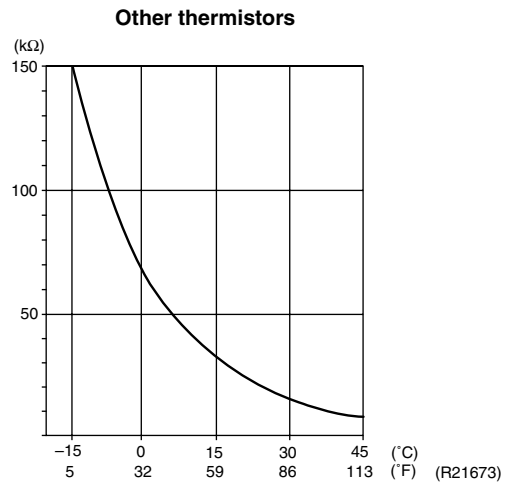
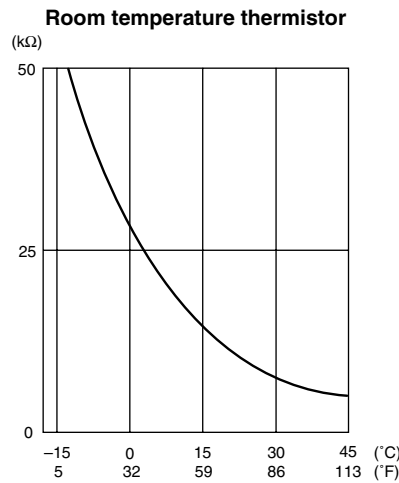

- When the room temperature thermistor is soldered on a PCB, remove the PCB from the control PCB to measure the resistance.
- When the connector of indoor heat exchanger thermistor is soldered on a PCB, remove the thermistor and measure the resistance.

5.2 Fan Motor Connector Output Check

Check No.03

- ◆ Fan motor wire breakdown / short circuit check
 1. Check the connector for connection.
 2. Turn the power off.
 3. Check if each resistance at the phases U - V and V - W is $90 \Omega \sim 100 \Omega$ (between the pins 12 - 9, and between 9 - 6).

- ◆ Motor control voltage check
 1. Check the connector for connection.
 2. Check the motor control voltage is generated (between the pins 2 - 3).

- ◆ Rotation pulse check
 1. Check the connector for connection.
 2. Turn the power on and stop the operation.
 3. Check if the Hall IC generates the rotation pulse 4 times when the fan motor is manually rotated once (between the pins 1 - 3).

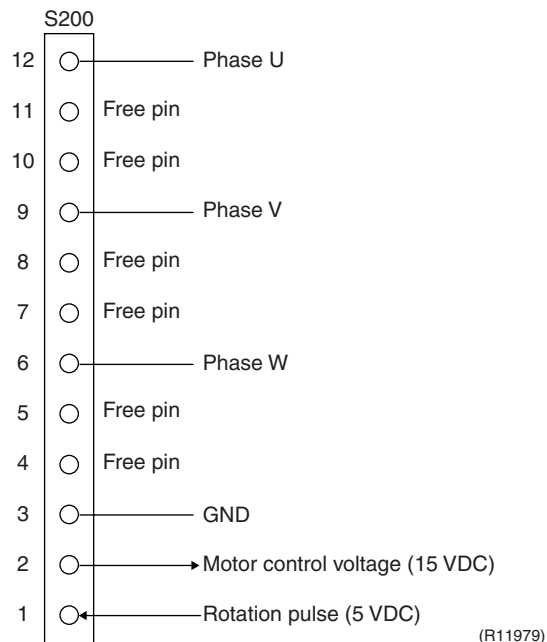

5.3 Power Supply Waveforms Check

Check No.11

Measure the power supply waveform between No. 1 and No. 2 on the terminal board, and check the waveform disturbance.

- Check if the power supply waveform is a sine wave (Fig.1).
- Check if there is waveform disturbance near the zero-cross (sections circled in Fig.2).

Fig.1

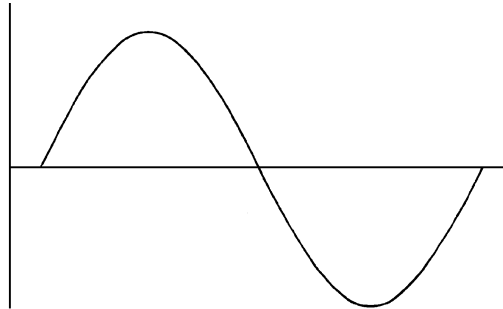
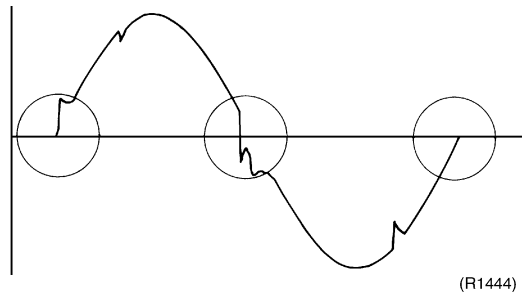

Fig.2



(R1736)

(R1444)

5.4 Electronic Expansion Valve Check

Check No.12

Conduct the followings to check the electronic expansion valve (EV).

1. Check if the EV connector is correctly connected to the PCB.
2. Turn the power off and on again, and check to see if the EV generates a latching sound.
3. If the EV does not generate a latching sound in the above step 2, disconnect the connector and check the continuity using a multimeter.
4. Check the continuity between the pins 1 - 6, 2 - 6, 3 - 6, and 4 - 6 (between the pins 1 - 5, 2 - 5, 3 - 5, 4 - 5 for the 5P connector models). If there is no continuity between the pins, the EV coil is faulty.
5. If the continuity is confirmed in step 3, the outdoor unit PCB (main PCB) is faulty.

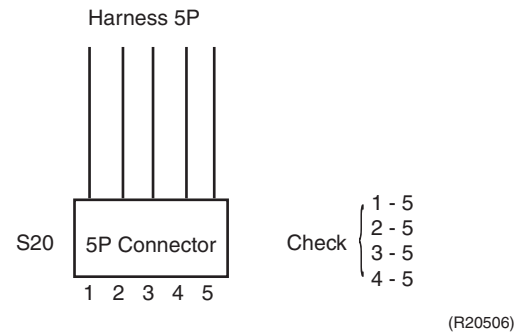
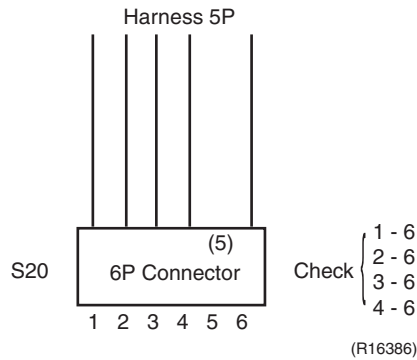

5.5 Four Way Valve Performance Check

Check No.13

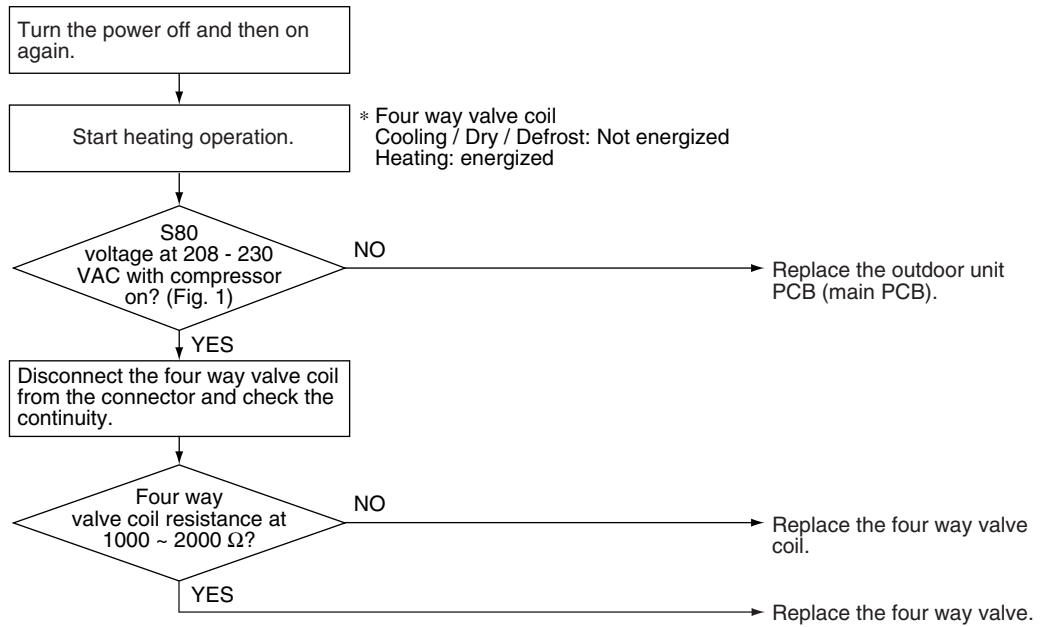

(R21674)

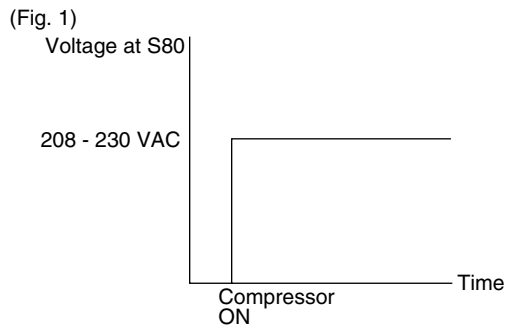

(R14674)

5.6 Inverter Unit Refrigerant System Check

Check No.14

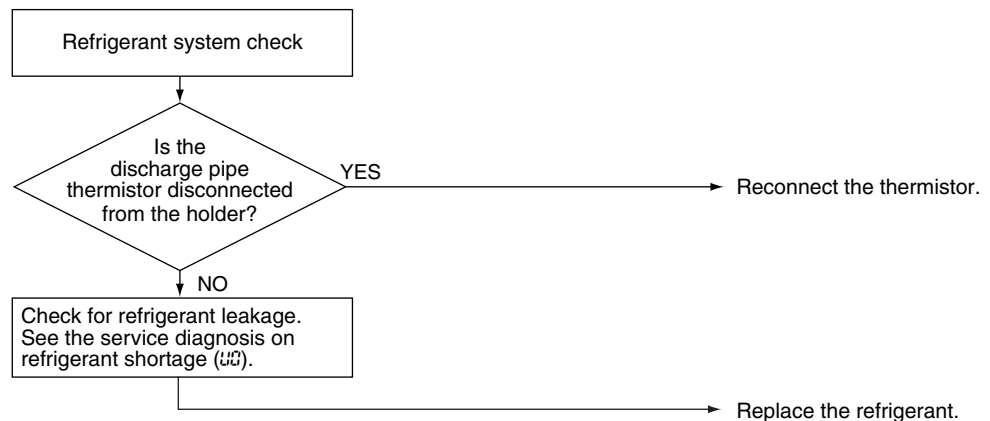

(R15833)

5.7 Inverter Analyzer Check

Check No.15

■ Characteristics

Inverter analyzer: RSUK0917C

If an abnormal stop occurs due to compressor startup failure or overcurrent output when using an inverter unit, it is difficult to judge whether the stop is caused by the compressor failure or some other failure (main PCB, power module, etc.). The inverter analyzer makes it possible to judge the cause of trouble easily and securely. (Connect an inverter analyzer as a quasi-compressor instead of compressor and check the output of the inverter.)

■ Operation Method

Step 1

Be sure to turn off the power.

Step 2

Install an inverter analyzer instead of a compressor.

Note:

Make sure the charged voltage of the built-in smoothing electrolytic capacitor drops to 10 VDC or below before carrying out the service work.

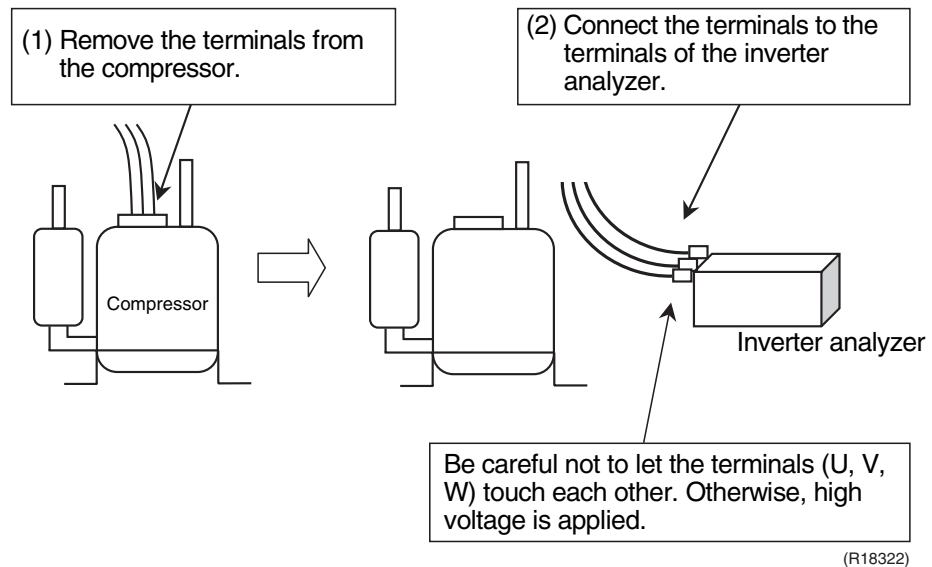

Reference:

If the terminals of the compressor are not FASTON terminals (difficult to remove the wire on the terminals), it is possible to connect wires available on site to the outdoor unit from output side of PCB. (Do not connect them to the compressor at the same time, otherwise it may result in incorrect detection.)

Step 3

Activate power transistor test operation from the indoor unit.

- (1) Turn the power on.
- (2) Press the center of the **TEMP** button and the **OFF** button on the remote controller at the same time.
- (3) Select ? with the **TEMP** ^ or **TEMP** v button.
- (4) Press the **FAN** button.
- (5) Press the **FAN ONLY** button to start the power transistor test operation.

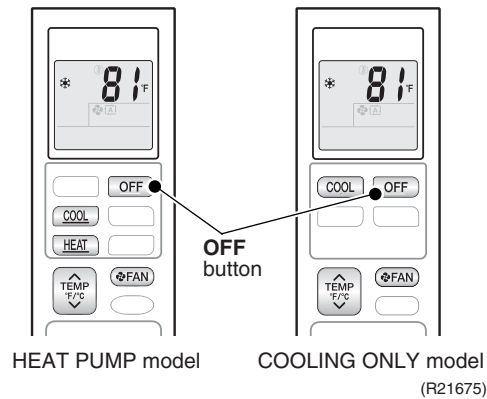

■ **Diagnose method (Diagnose according to 6 LEDs lighting status.)**

- (1) If all the LEDs are lit uniformly, the compressor is defective.
→ Replace the compressor.
- (2) If the LEDs are not lit uniformly, check the power module.
→ Refer to **Check No.22**.
- (3) If NG in **Check No.22**, replace the power module.
(Replace the main PCB. The power module is united with the main PCB.)
If OK in **Check No.22**, check if there is any solder cracking on the PCB.
- (4) If any solder cracking is found, replace the PCB or repair the soldered section.
If there is no solder cracking, replace the PCB.

**Caution**

- (1) When the output frequency is low, the LEDs blink slowly. As the output frequency increases, the LEDs blink quicker. (The LEDs look like they are lit.)
- (2) On completion of the inverter analyzer diagnosis, be sure to re-crimp the FASTON terminals. Otherwise, the terminals may be burned due to loosening.

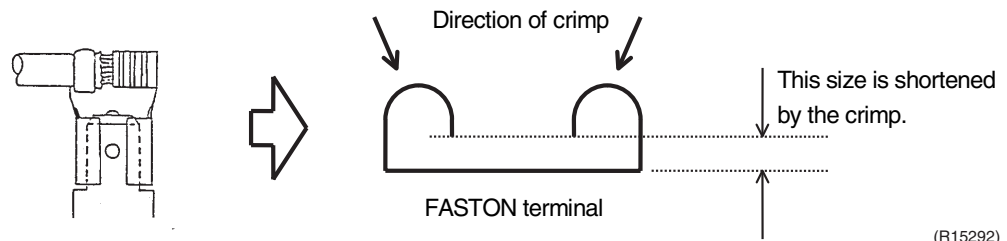

5.8 Rotation Pulse Check on the Outdoor Unit PCB

Check No.16

Make sure that the voltage of $320 + 100 \text{ V} \sim 320 - 50 \text{ V}$ is applied.

1. Set operation off and power off. Disconnect the connector S70 or S71.
2. Check that the voltage between the pins 4 - 7 is 320 VDC.
3. Check that the control voltage between the pins 3 - 4 is 15 VDC.
4. Check that the rotation command voltage between the pins 2 - 4 is 0 ~ 6.5 VDC.
5. Keep operation off and power off. Connect the connector S70 or S71.
6. Check whether 4 rotation pulses (0 ~ 15 VDC) are input at the pins 1 - 4 when the fan motor is rotated 1 turn by hand.

When the fuse is melted, check the outdoor fan motor for proper function.

If NG in step 2 → Defective PCB → Replace the outdoor unit PCB (main PCB).

If NG in step 4 → Defective Hall IC → Replace the outdoor fan motor.

If OK in both steps 2 and 4 → Replace the outdoor unit PCB (main PCB).

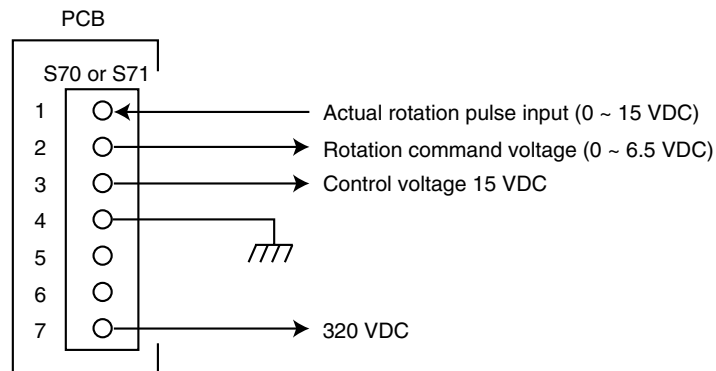

(R20507)

5.9 Installation Condition Check

Check No.17

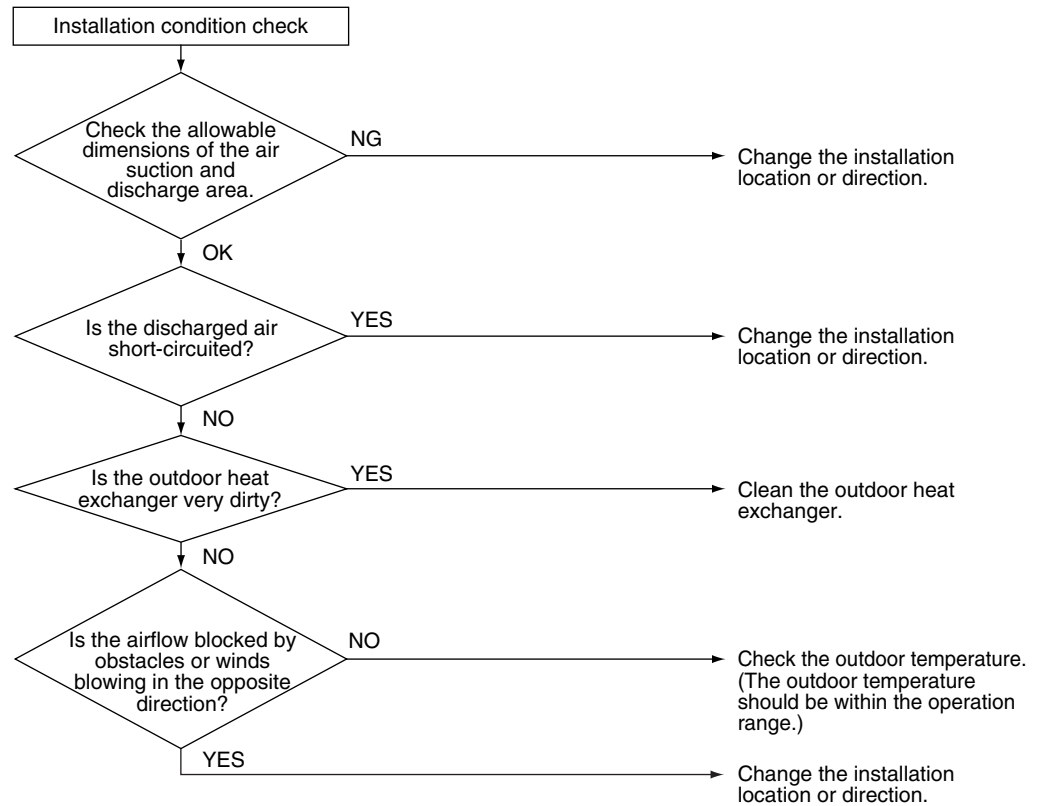

(R19394)

5.10 Discharge Pressure Check

Check No.18

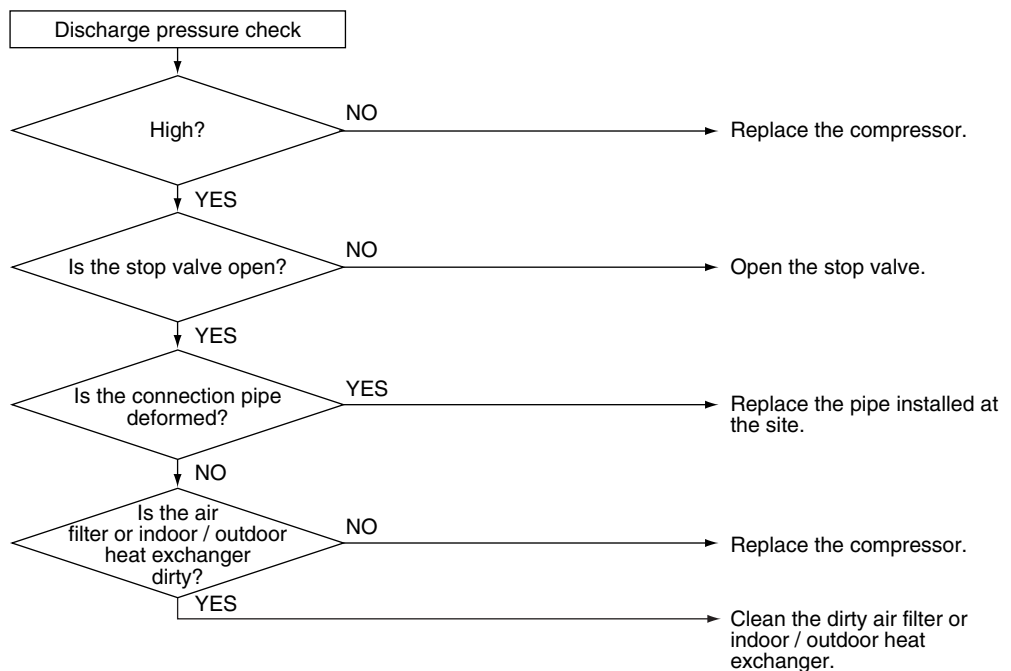

(R19385)

5.11 Outdoor Fan System Check

Check No.19

DC motor

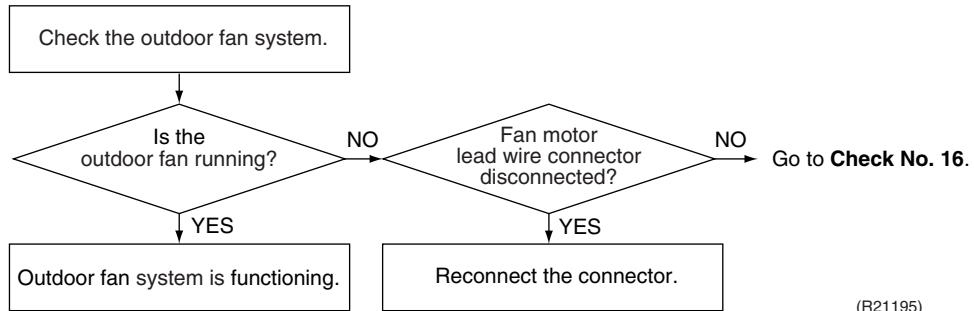

(R21195)

5.12 Main Circuit Short Check

Check No.20

Check to make sure that the voltage between (+) and (-) of the diode bridge (DB1) is approximately 0 V before checking.

- Measure the resistance between the pins of the DB1 referring to the table below.
- If the resistance is ∞ or less than 1 k Ω , short circuit occurs on the main circuit.

Positive terminal (+) of digital multimeter	~ (2, 3)	+ (4)	~ (2, 3)	- (1)
Negative terminal (-) of digital multimeter	+ (4)	~ (2, 3)	- (1)	~ (2, 3)
Resistance is OK.	several k Ω ~ several M Ω			
Resistance is NG.	0 Ω or ∞			

09/12 class, RKN18NMVJU

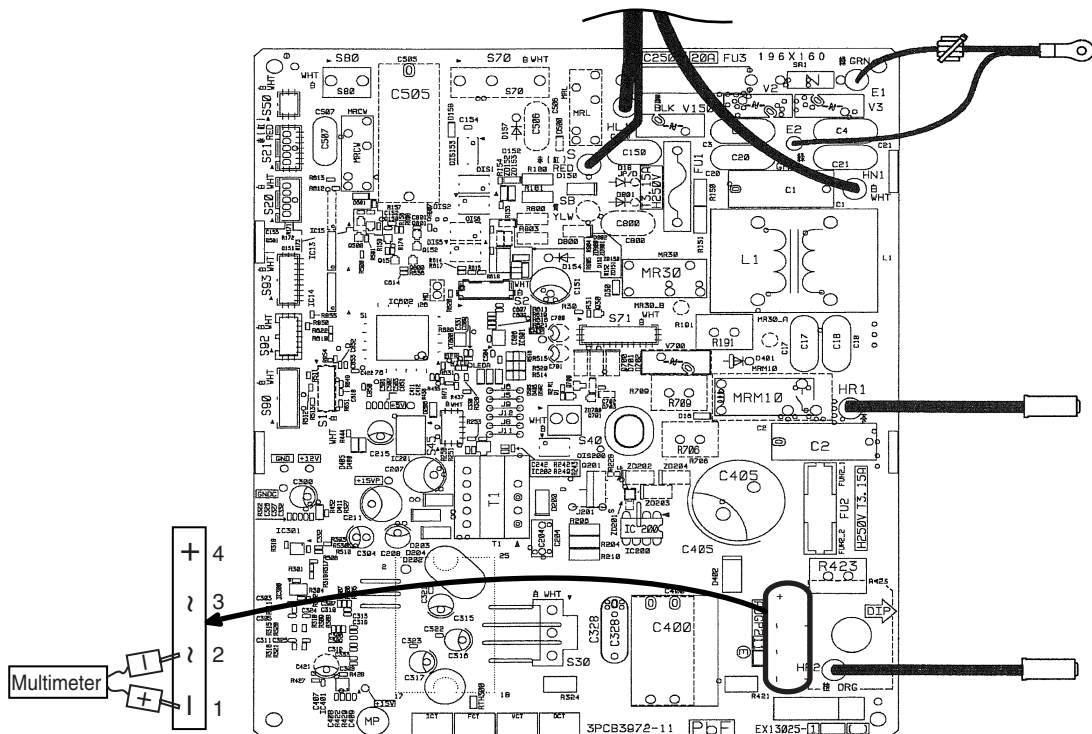

(R20698)

RXN18NMVJU, RK(X)18NMVJU, 24 class

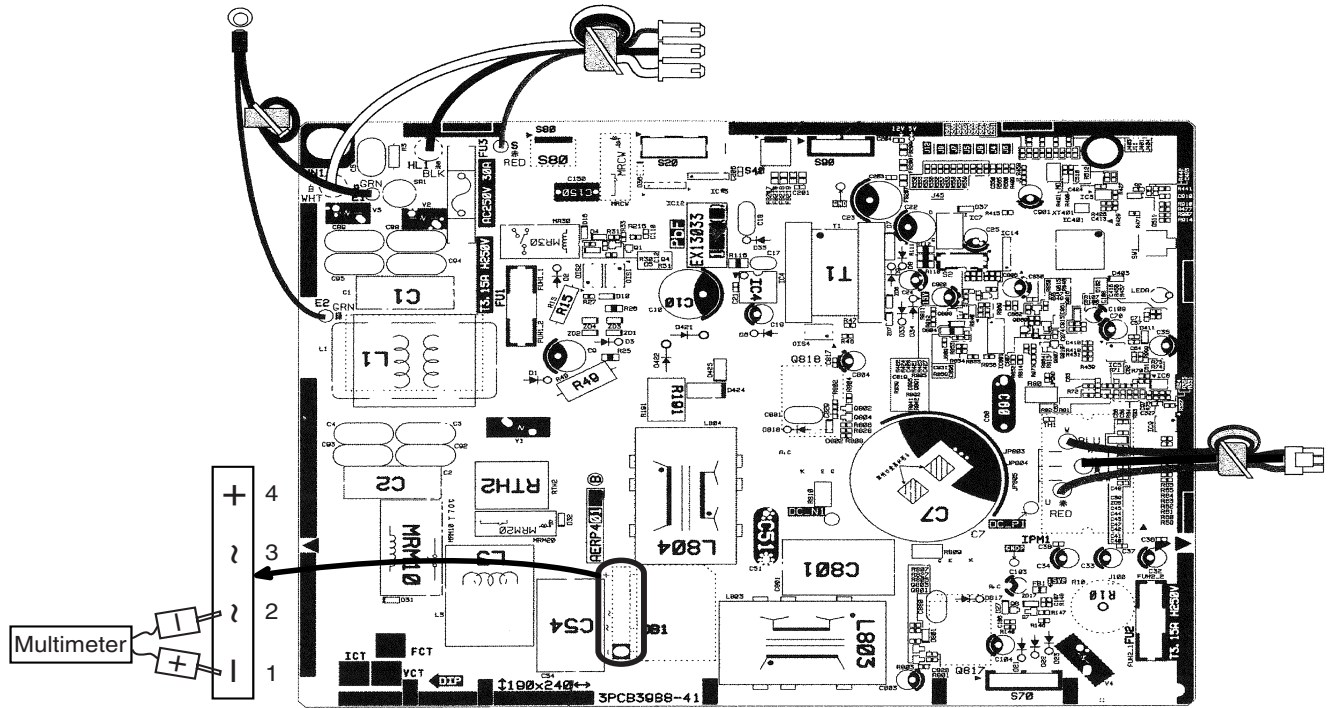

(R20701)

5.13 Power Module Check

Check No.22

Check to make sure that the voltage between (+) and (-) of the power module is approximately 0 V before checking.

- Disconnect the compressor harness connector from the outdoor unit PCB. To disengage the connector, press the protrusion on the connector.
- Follow the procedure below to measure resistance between the terminals of the power module and the terminals of the compressor with a multimeter. Evaluate the measurement results referring to the following table.

Positive terminal (+) of digital multimeter	Power module (+)	UVW	Power module (-)	UVW
Negative terminal (-) of digital multimeter	UVW	Power module (+)	UVW	Power module (-)
Resistance is OK.	several kΩ ~ several MΩ			
Resistance is NG.	0 Ω or ∞			

09/12 class, RKN18NMVJU

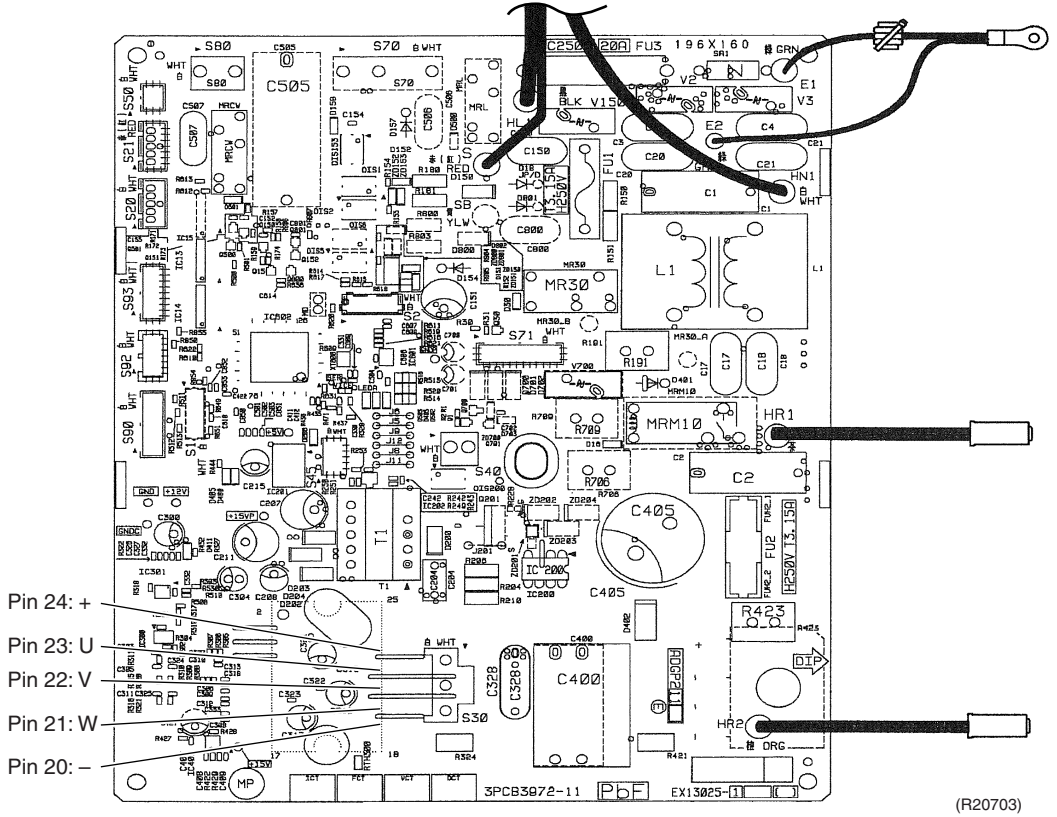

(R20703)

RXN18NMVJU, RK(X)18NMVJU, 24 class

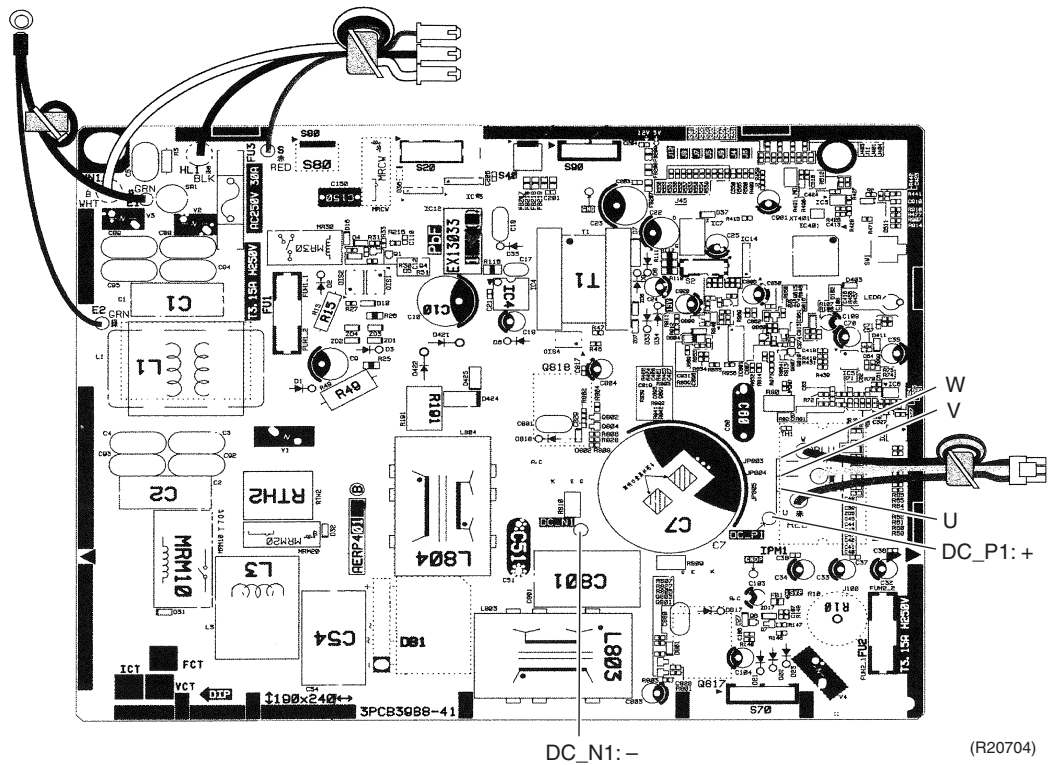

(R20704)

Part 7

Trial Operation and Field Settings

1. Tips for Servicing	103
1.1 Pump Down Operation	103
1.2 Forced Cooling Operation	103
2. Trial Operation	104
3. Field Settings	105
3.1 Temperature Display Switch	105
3.2 When 2 Units are Installed in 1 Room.....	106
3.3 Facility Setting Switch (cooling at low outdoor temperature) (Only for RK(X) series)	107
4. Silicon Grease on Power Transistor / Diode Bridge	108

1. Tips for Servicing

1.1 Pump Down Operation

Outline

In order to protect the environment, be sure to conduct pump down operation when relocating or disposing of the unit.

Detail

1. Remove the valve caps from the liquid stop valve and the gas stop valve.
2. Carry out forced cooling operation.
3. After 5 to 10 minutes, close the liquid stop valve with a hexagonal wrench.
4. After 2 to 3 minutes, close the gas stop valve and stop the forced cooling operation.

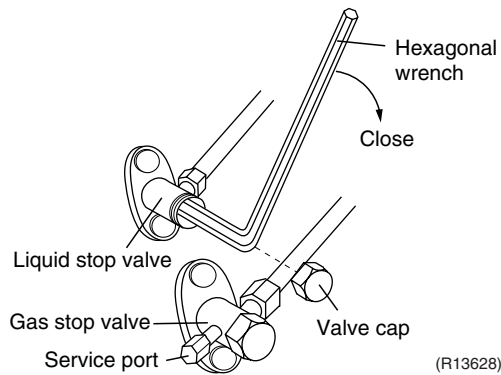

Refer to forced cooling operation below.

1.2 Forced Cooling Operation

Item	Forced Cooling
Conditions	The forced cooling operation is allowed when both the following conditions are met. 1) The outdoor unit is not abnormal and not in the 3-minute standby mode. 2) The outdoor unit is not operating.
Start	Press the forced cooling operation ON/OFF button (SW1) on the indoor unit for 5 seconds.
Command frequency	09/12 class, RKN18NMVJU: 58 Hz RXN18NMVJU, RK(X)18NMVJU, 24 class: 30 Hz
End	The forced cooling operation ends when any of the following conditions is fulfilled. 1) The operation ends automatically after 15 minutes. 2) Press the forced cooling operation ON/OFF button (SW1) on the indoor unit again. 3) Press the ON/OFF button on the remote controller.
Others	Protection functions have priority over all other functions during forced cooling operation.

Indoor Unit

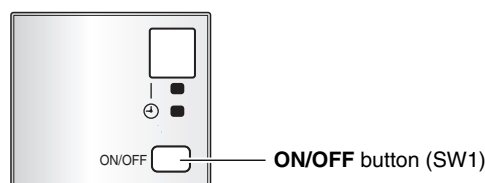

(R21069)

2. Trial Operation

Outline

Carry out the trial operation in accordance with the operation manual to ensure that all functions and parts, such as flap movement, are working properly.

Trial operation should be carried out in either cooling or heating operation.

Detail

1. Measure the power supply voltage and make sure that it falls within the specified range.
2. In cooling operation, select the lowest programmable temperature (18°C, 64°F); in heating operation, select the highest programmable temperature (30°C, 86°F).
 - ♦ Trial operation may be disabled in either operation mode depending on the room temperature.
 - ♦ After trial operation is complete, set the temperature to a normal level (26 ~ 28°C, 78 ~ 82°F in cooling, 20 ~ 24°C, 68 ~ 75°F in heating operation).
 - ♦ For protection, the system does not start for 3 minutes after it is turned off.

ARC480 Series

- (1) Press the center of the **TEMP** button and the **OFF** button on the remote controller at the same time.
- (2) Select ? (trial operation) with the **TEMP** ^ or **TEMP** v button.
- (3) Press the **FAN** button to enter the trial operation mode.
- (4) Press the **COOL** or **HEAT** button to start trial operation.
- (5) Trial operation terminates in approximately 30 minutes and switches into the normal mode. To quit trial operation, press the **OFF** button.

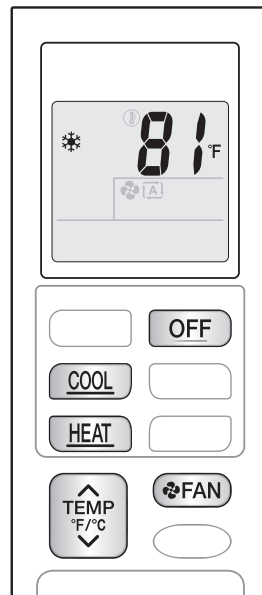

HEAT PUMP model

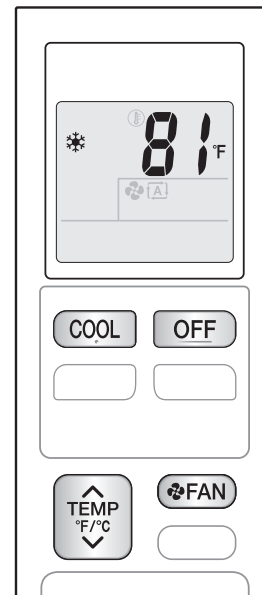

COOLING ONLY model

(R21821)

3. Field Settings

3.1 Temperature Display Switch

- You can select Fahrenheit or Celsius for temperature display.
- Press the **TEMP▲** and **ON TIMER** buttons simultaneously for 5 seconds to change the unit of temperature display.
- You can also change the unit of temperature display by pressing the **TEMP▲** and ▼ buttons simultaneously for 5 seconds.

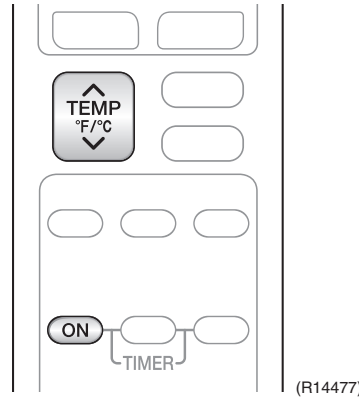

3.2 When 2 Units are Installed in 1 Room

Outline

When 2 indoor units are installed in 1 room, 1 of the 2 indoor units and the corresponding wireless remote controller can be set for different addresses.

Procedure

- (1) Remove the battery cover of the remote controller.
- (2) Cut the address jumper.
- (3) Press the center of the **TEMP** button and the **OFF** button on the remote controller at the same time.
- (4) Select \mathcal{R} (address setting) with the **TEMP** \wedge or **TEMP** \vee button.
- (5) Press the **FAN** button to enter the address setting mode.
→ The indoor unit operation lamp blinks for 1 minute.
- (6) Press the indoor unit **ON/OFF** button while the operation lamp is blinking.
- (7) Press the **FAN** button on the remote controller for 5 seconds to return to the normal mode.

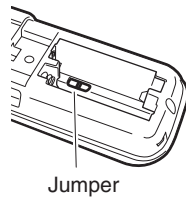

Jumper	Address
EXIST	1
CUT	2

(R21071)

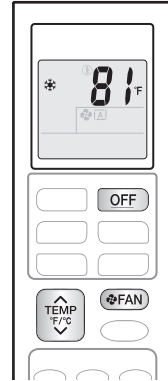

(R21822)

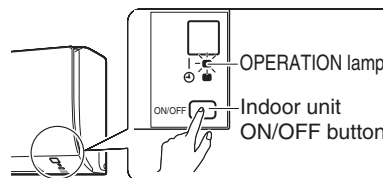

(R21072)

3.3 Facility Setting Switch (cooling at low outdoor temperature) (Only for RK(X) series)

Outline

This function is limited to use for facilities (where the target of air conditioning is equipment, such as in a server room). Never use it in a residence or office where there are people present.

Detail

You can expand the operation range to -15°C (5°F) by cutting the jumper on the outdoor unit PCB. Note that the operation may stop if the outdoor temperature drops below -15°C (5°F). If the outdoor temperature rises, the operation starts again.



For the location of the jumper, refer to page 20, 21.



Caution

Replace the PCB if you accidentally cut a wrong jumper.

Jumpers are necessary for electronic circuit. Improper operation may occur if you cut any of them.



Caution

1. If the outdoor unit is installed where the outdoor heat exchanger of the unit is exposed to direct wind, provide a windbreak wall.
2. Intermittent noises may be produced by the indoor unit due to the outdoor fan turning on and off when using facility settings.
3. Do not place humidifiers or other items which might raise the humidity in rooms where facility settings are being used.
A humidifier might cause dew jumping from the indoor unit outlet vent.
4. Cutting jumper sets the indoor fan tap to the highest position.

4. Silicon Grease on Power Transistor / Diode Bridge

Outline

Apply the specified silicon grease to the heat radiation part of a power transistor / diode bridge when you replace an outdoor unit PCB. The silicon grease encourages the heat radiation of a power transistor / diode bridge.

Detail

1. Wipe off the old silicon grease completely.
2. Apply the silicon grease evenly. See the illustrations below for examples of application.
3. Tighten the screws of the power transistor / diode bridge.
4. Make sure that the heat radiation parts are firmly contacted to the radiation fin.

Note: Smoke emission may be caused by bad heat radiation when the silicon grease is not appropriately applied.

- OK: Evenly applied

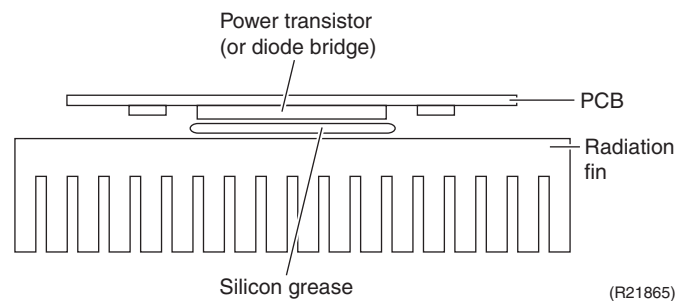

- NG: Not evenly applied

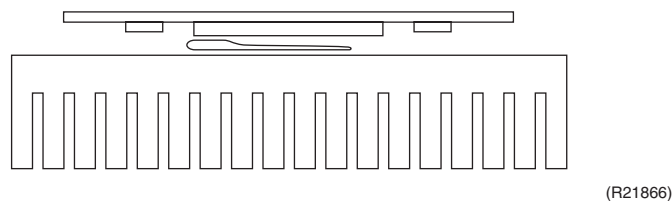

- NG: Foreign matter is stuck.

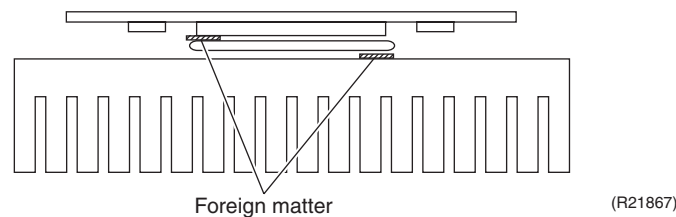

Part 8

Appendix

1. Piping Diagrams.....	110
1.1 Indoor unit	110
1.2 Outdoor Unit.....	112
2. Wiring Diagrams.....	118
2.1 Indoor Unit.....	118
2.2 Outdoor Unit.....	119

1. Piping Diagrams

1.1 Indoor unit

1.1.1 Cooling Only

FTKN09NMVJU

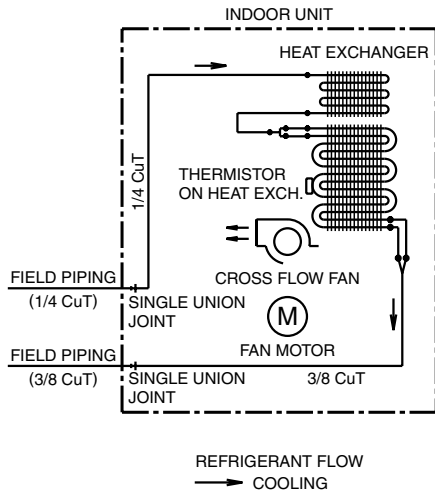

4D092107

FTKN12NMVJU, FTK09/12NMVJU

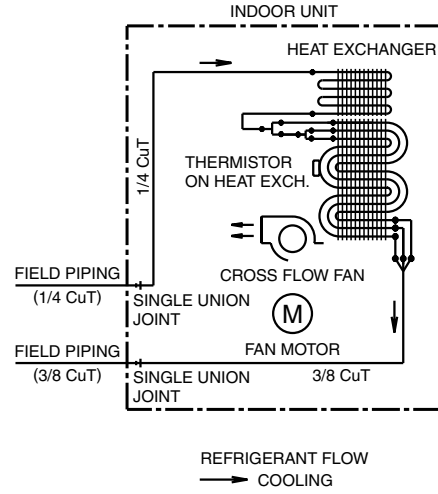

4D092108

FTKN18NMVJU, FTK18NMVJU

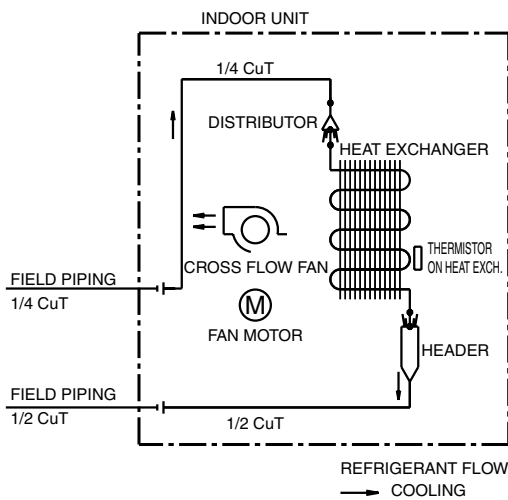

4D091771

FTKN24NMVJU, FTK24NMVJU

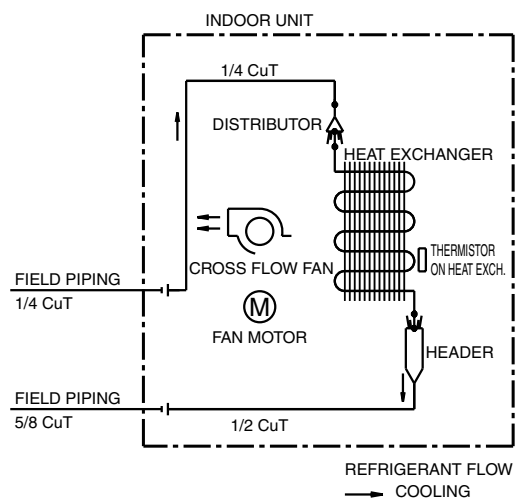

4D091770

1.1.2 Heat Pump

FTXN09NMVJU

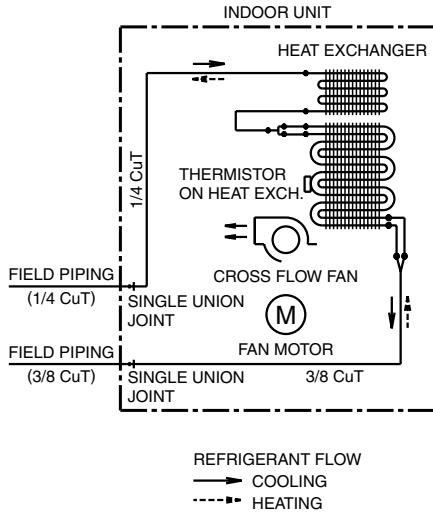

4D091706A

FTXN12NMVJU, FTX09/12NMVJU

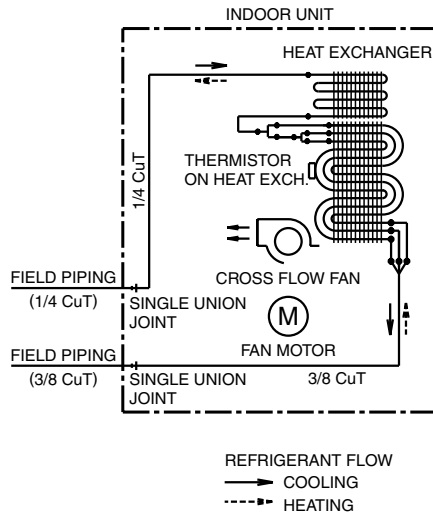

4D091708A

FTXN18NMVJU, FTX18NMVJU

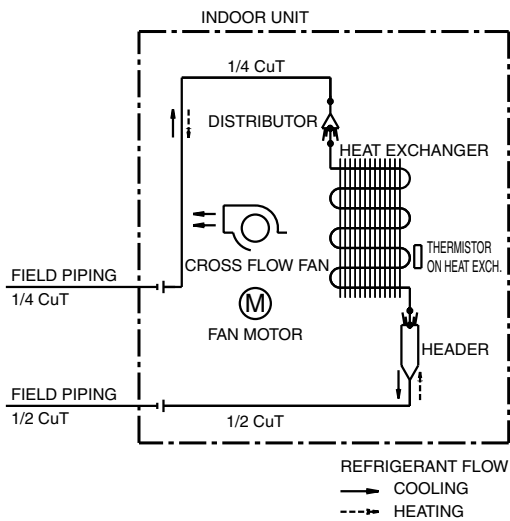

4D091769

FTXN24NMVJU, FTX24NMVJU

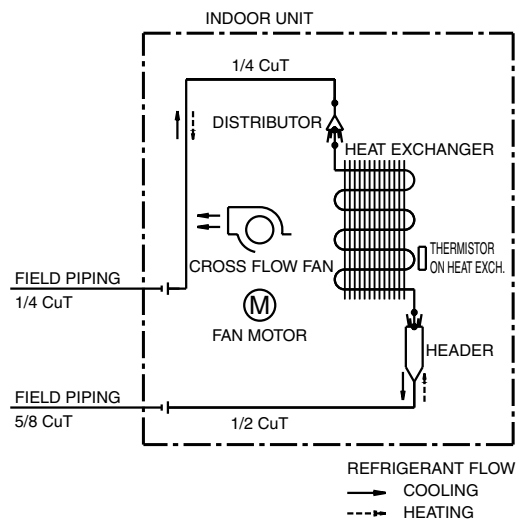

4D091768

1.2 Outdoor Unit

1.2.1 Cooling Only

RKN09NMVJU, RK09NMVJU

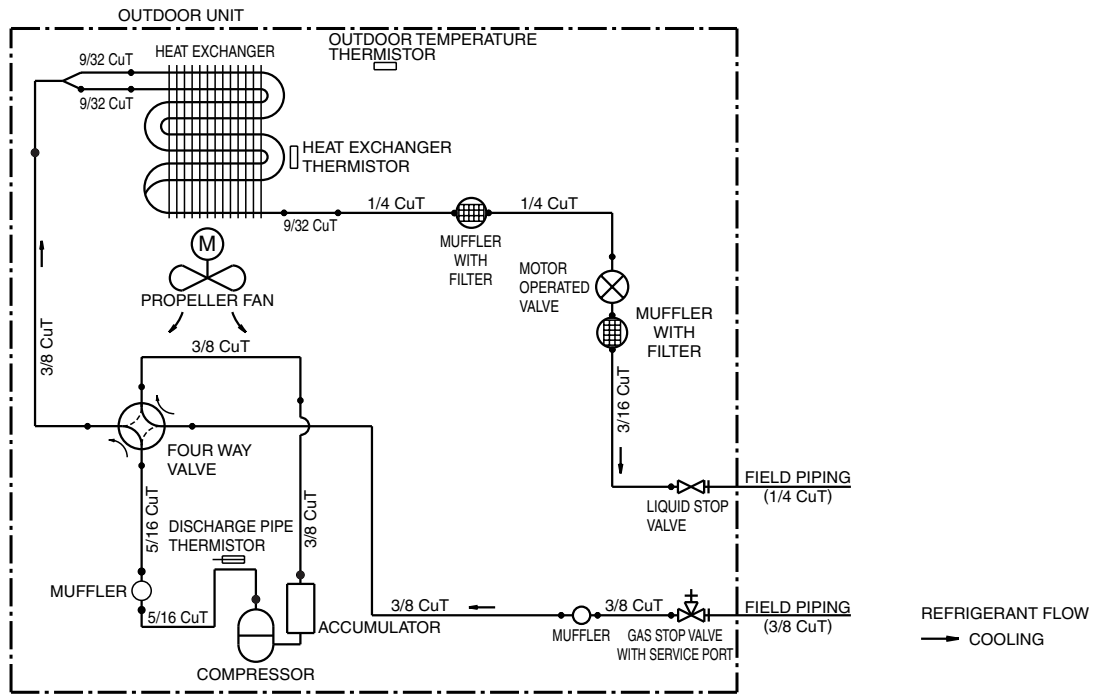

3D092245

RKN12NMVJU, RK12NMVJU

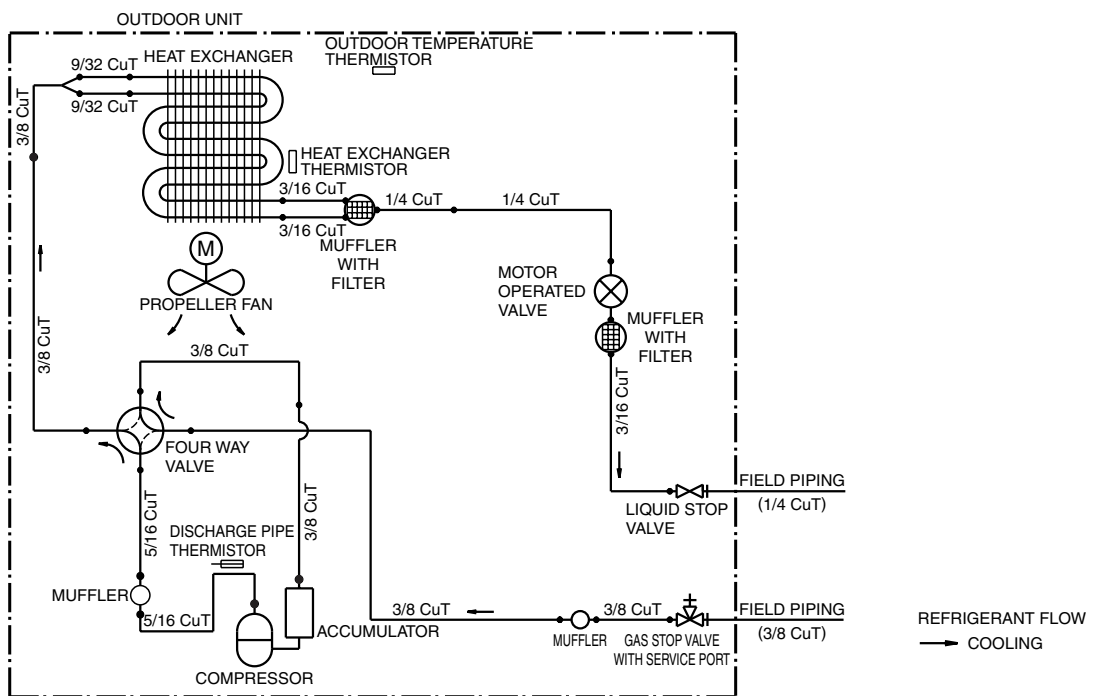

3D092208

RKN18NMVJU

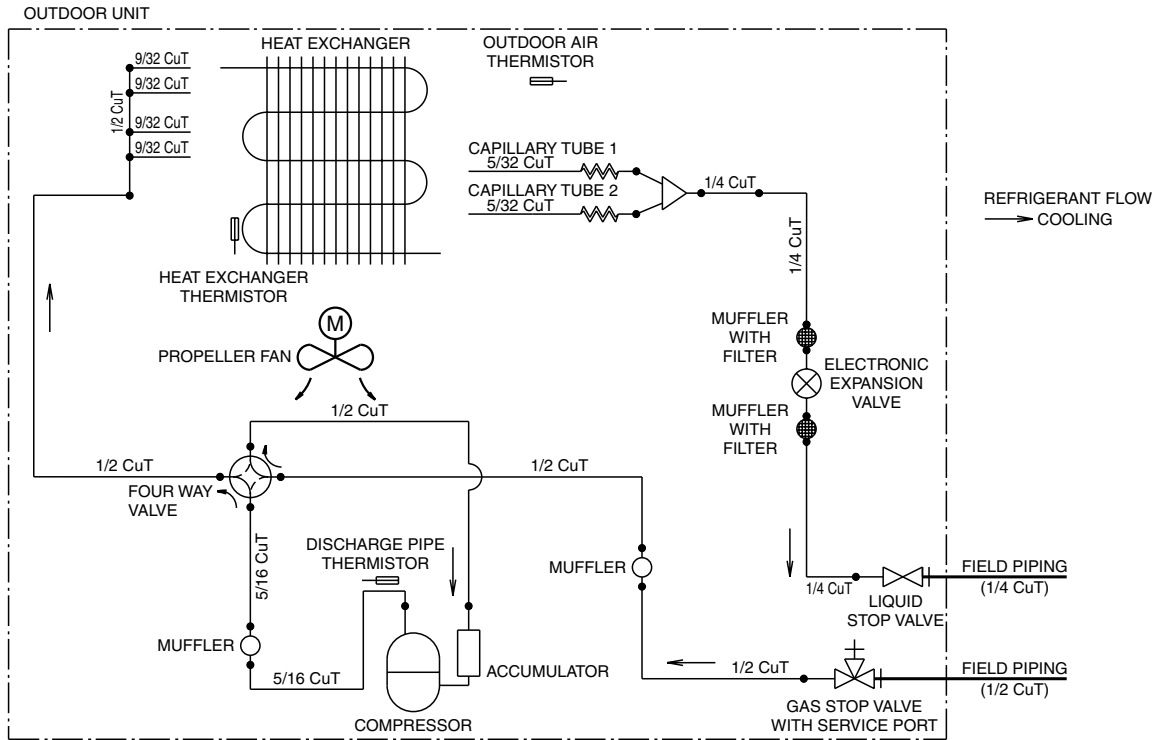

RK18NMVJU

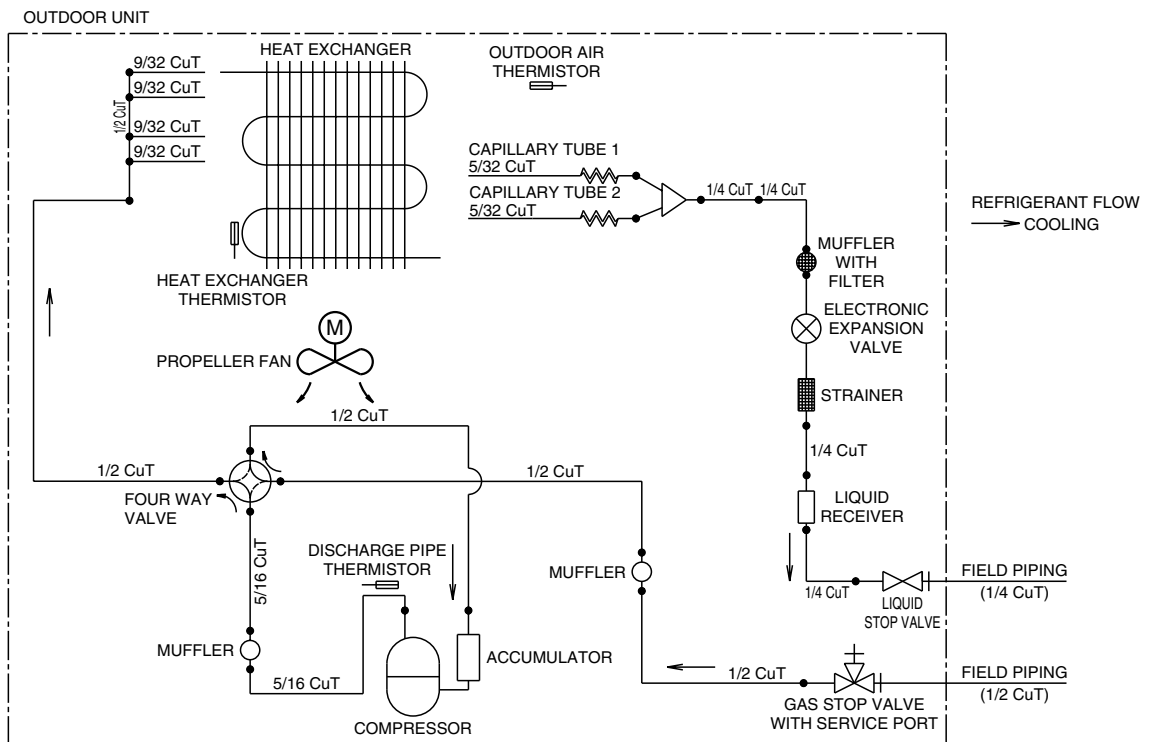

RKN24NMVJU

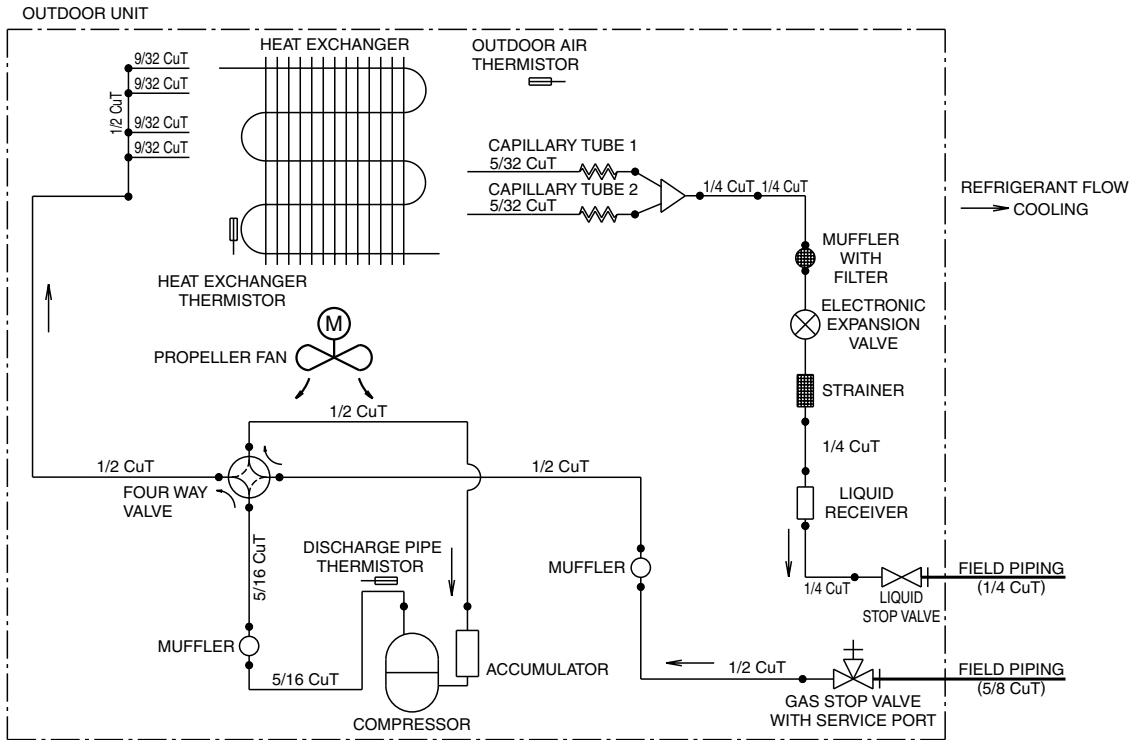

RK24NMVJU

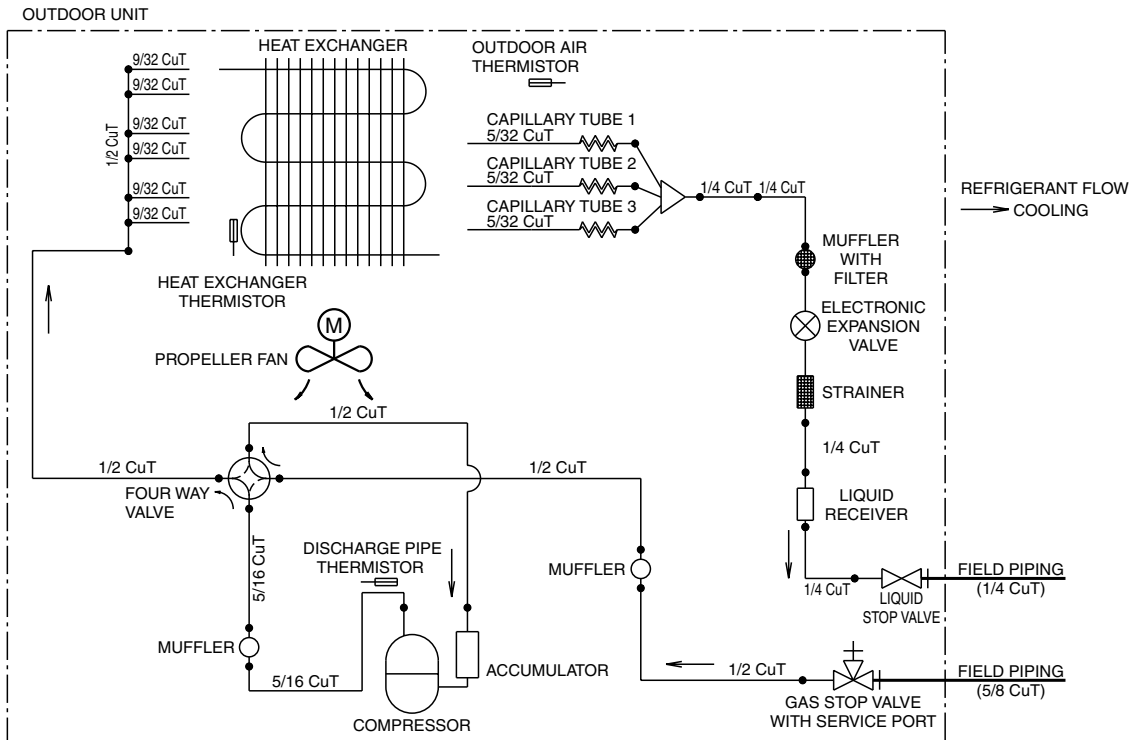

1.2.2 Heat Pump

RXN09NMVJU, RX09NMVJU

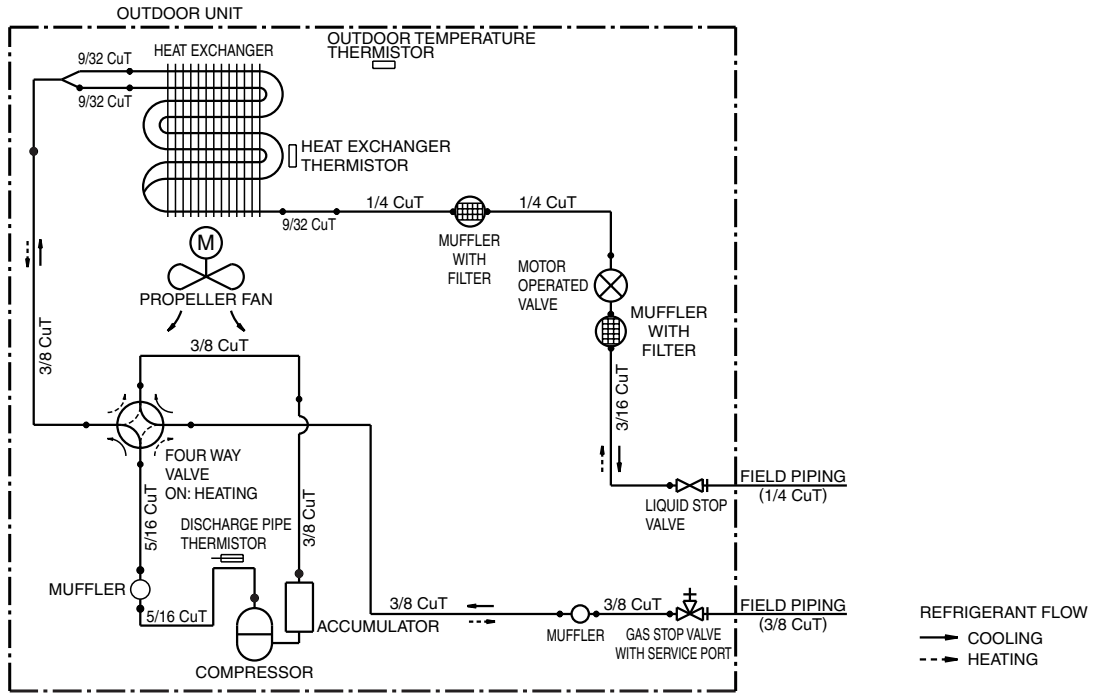

3D092244

RXN12NMVJU, RX12NMVJU

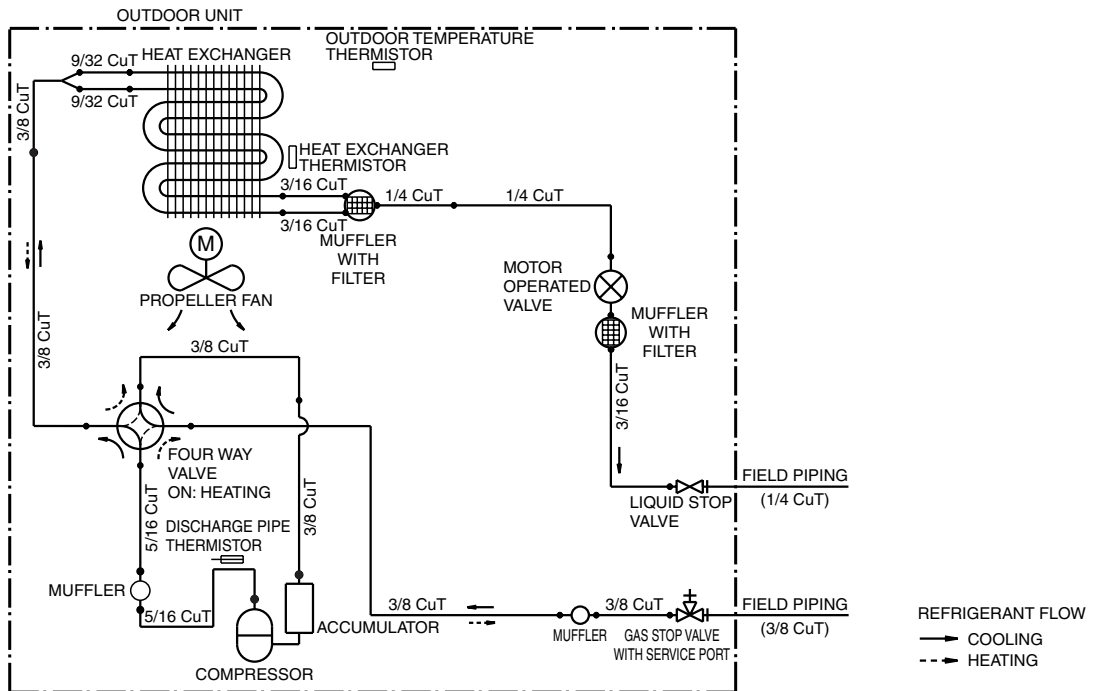

3D092207

RXN18NMVJU, RX18NMVJU

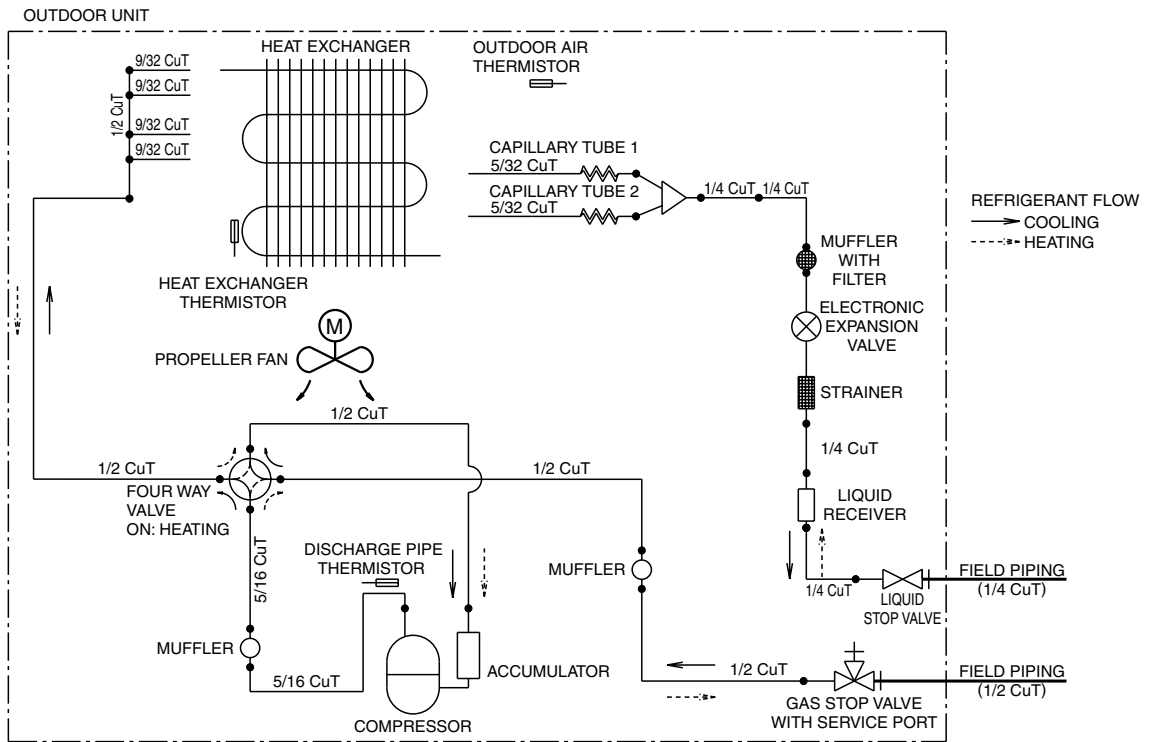

3D092220

RXN24NMVJU

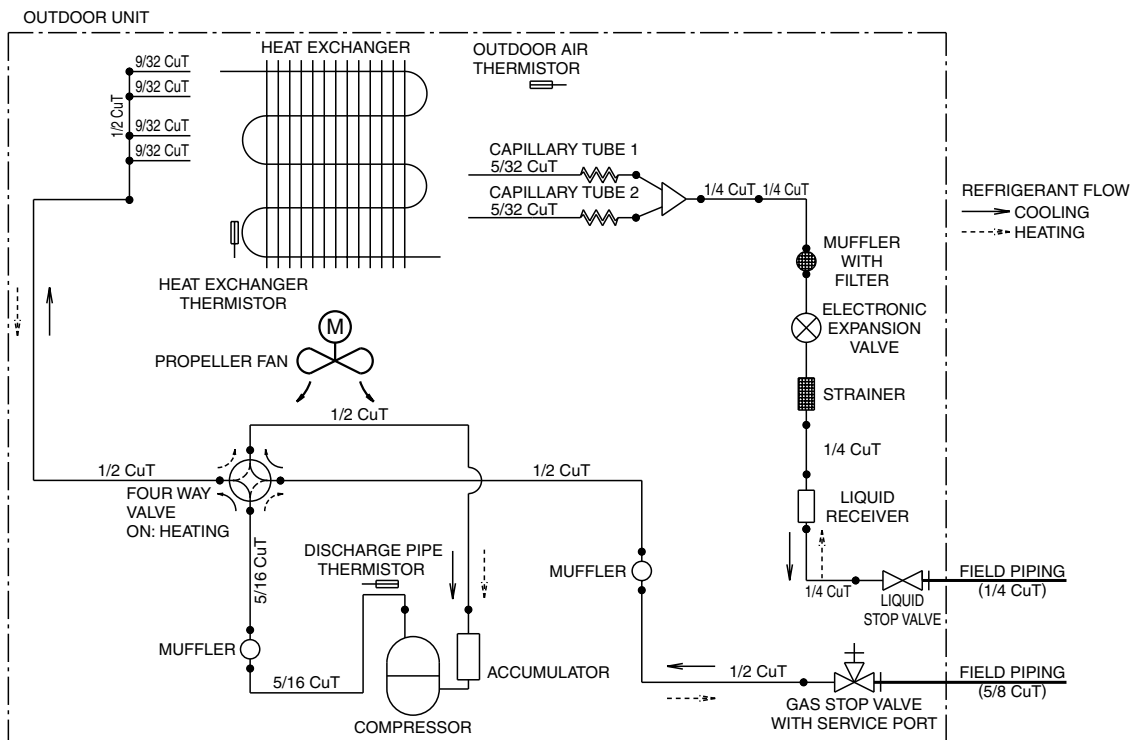

3D092221

RX24NMVJU

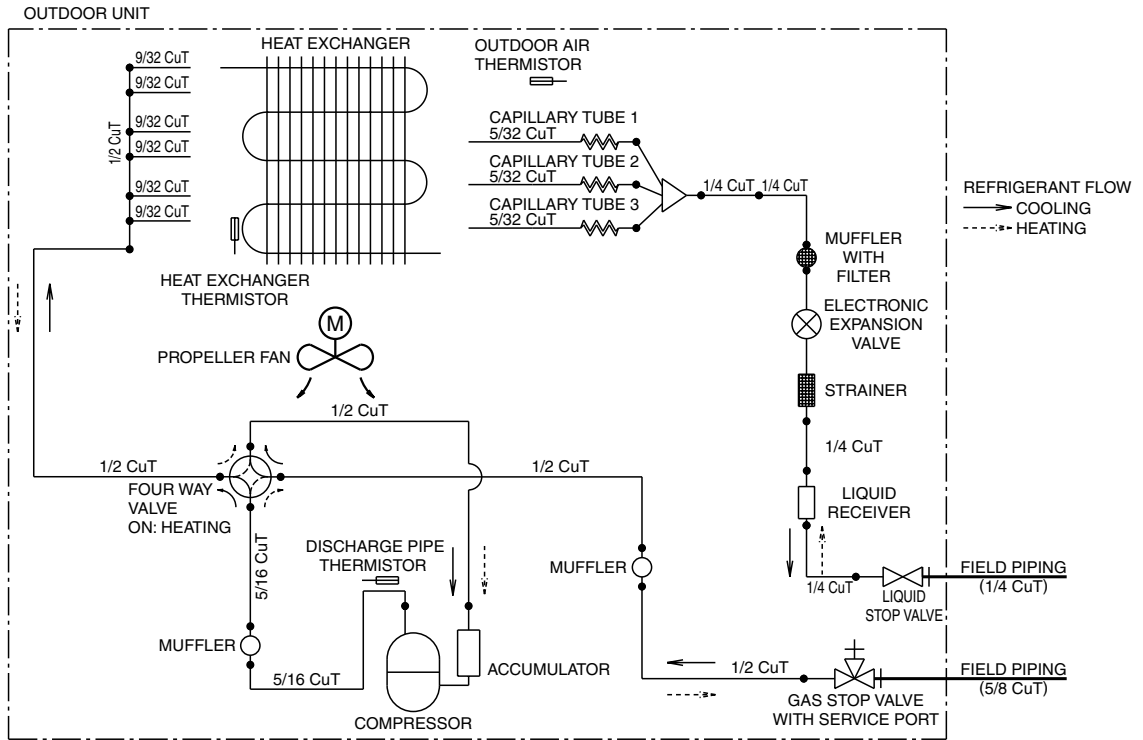

3D092249

2. Wiring Diagrams

2.1 Indoor Unit

FTK(X)N09/12NMVJU, FTK(X)09/12NMVJU

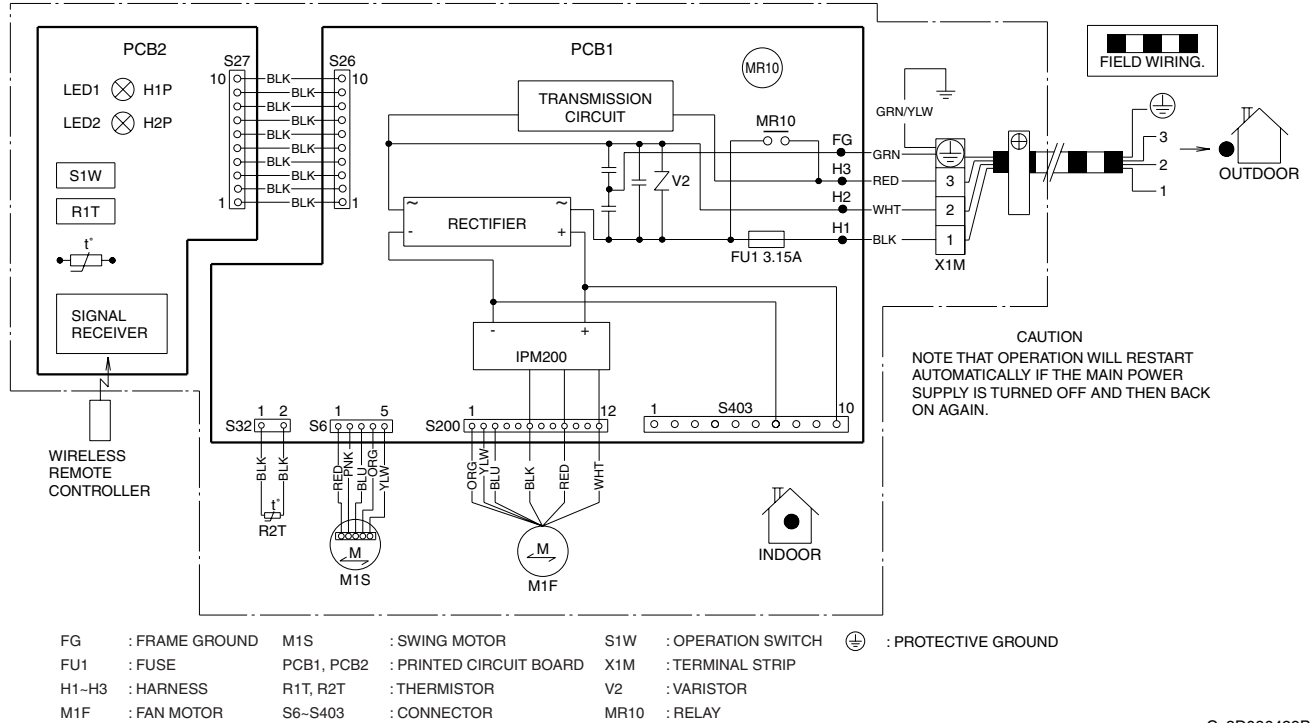

FTK(X)N18/24NMVJU, FTK(X)18/24NMVJU

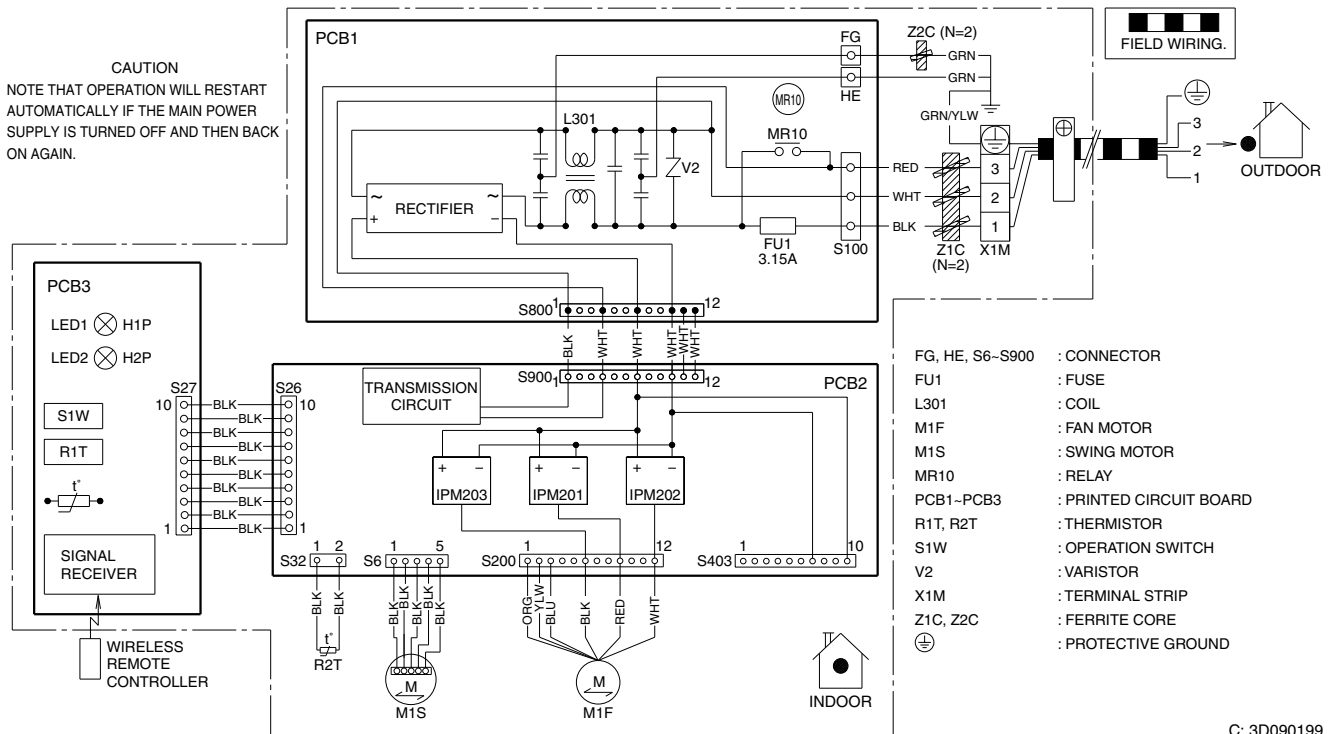

2.2 Outdoor Unit

RK(X)N09/12NMVJU, RK(X)09/12NMVJU

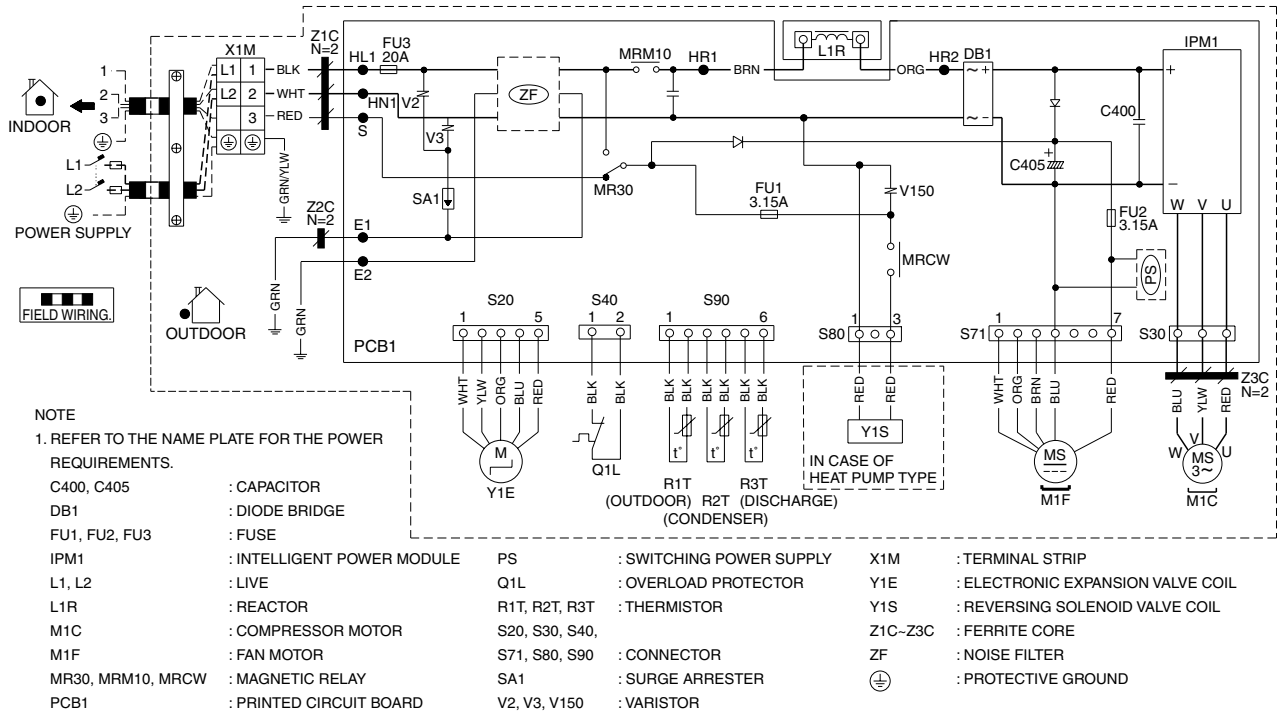

C: 3D089069

RKN18NMVJU

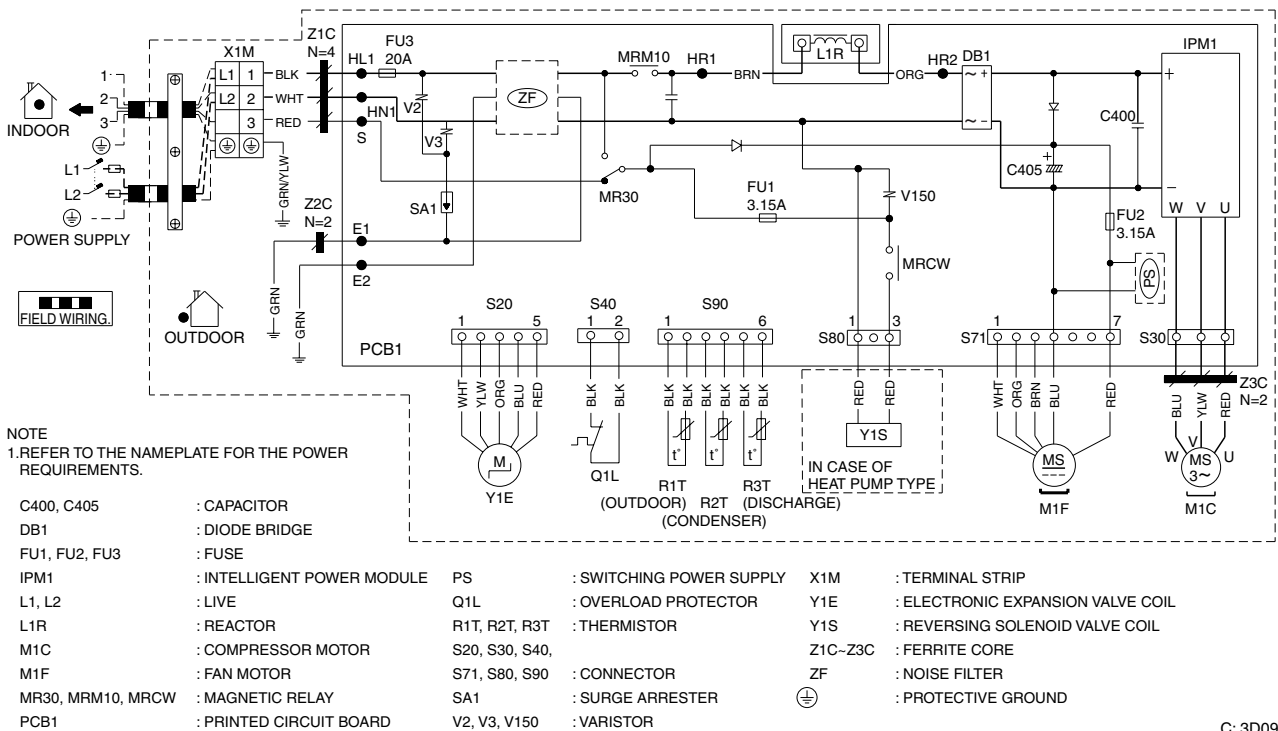

C: 3D091491

RXN18NMVJU, RK(X)N24NMVJU, RK(X)18/24NMVJU

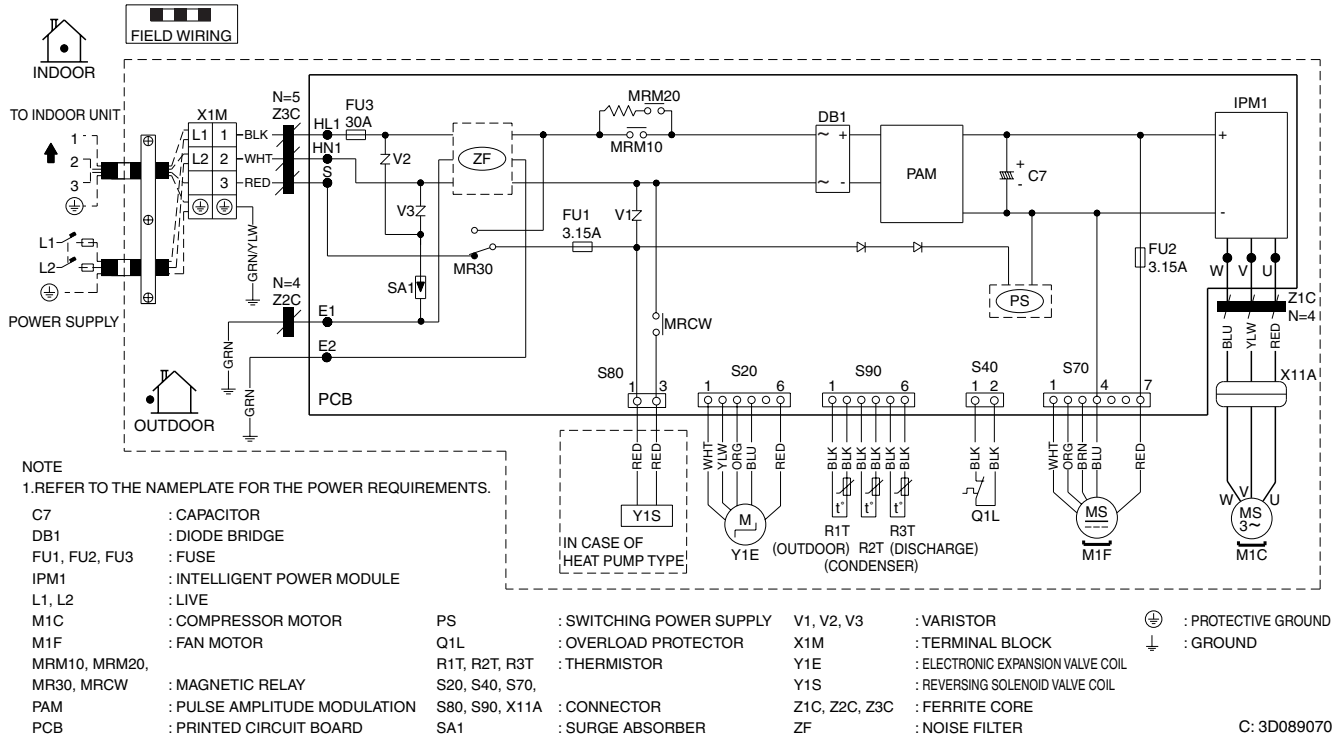

Revision History

Month / Year	Version	Revised contents
03 / 2015	SiUS041501E	First edition

Warning



- Daikin products are manufactured for export to numerous countries throughout the world. Prior to purchase, please confirm with your local authorized importer, distributor and/or retailer whether this product conforms to the applicable standards, and is suitable for use, in the region where the product will be used. This statement does not purport to exclude, restrict or modify the application of any local legislation.
- Ask a qualified installer or contractor to install this product. Do not try to install the product yourself. Improper installation can result in water or refrigerant leakage, electrical shock, fire or explosion.
- Use only those parts and accessories supplied or specified by Daikin. Ask a qualified installer or contractor to install those parts and accessories. Use of unauthorized parts and accessories or improper installation of parts and accessories can result in water or refrigerant leakage, electrical shock, fire or explosion.
- Read the user's manual carefully before using this product. The user's manual provides important safety instructions and warnings. Be sure to follow these instructions and warnings.

If you have any inquiries, please contact your local importer, distributor and/or retailer.

Cautions on product corrosion

1. Air conditioners should not be installed in areas where corrosive gases, such as acid gas or alkaline gas, are produced.
2. If the outdoor unit is to be installed close to the sea shore, direct exposure to the sea breeze should be avoided. If you need to install the outdoor unit close to the sea shore, contact your local distributor.

Dealer

© All rights reserved

● Specifications, designs and other content appearing in this brochure are current as of March 2015 but subject to change without notice.