

**40MB\*D**  
**Ducted Style Ductless System**  
**Sizes 09 to 48**



# Installation Instructions



**NOTE:** Read the entire instruction manual before starting the installation.

**NOTE:** Images are for illustration purposes only. Actual models may differ slightly.

## TABLE OF CONTENTS

	PAGE
SAFETY CONSIDERATIONS .....	2
PARTS LIST .....	3
SYSTEM REQUIREMENTS .....	4
WIRING .....	4
DIMENSIONS .....	5
CLEARANCES .....	6
INSTALLATION LOCATION REQUIREMENTS .....	7
INDOOR UNIT INSTALLATION .....	7
FAN PERFORMANCES .....	9
ELECTRICAL DATA .....	17
CONNECTION DIAGRAMS .....	17
WIRELESS REMOTE CONTROL INSTALLATION .....	19
START-UP .....	20
TROUBLESHOOTING .....	21

## SAFETY CONSIDERATIONS

Installing, starting up, and servicing air-conditioning equipment can be hazardous due to system pressures, electrical components, and equipment location (roofs, elevated structures, etc.).

Only trained, qualified installers and service mechanics should install, start-up, and service this equipment.

Untrained personnel can perform basic maintenance functions such as cleaning coils. All other operations should be performed by trained service personnel.

When working on the equipment, observe precautions in the literature and on tags, stickers, and labels attached to the equipment.

Follow all safety codes. Wear safety glasses and work gloves. Keep quenching cloth and fire extinguisher nearby when brazing. Use care in handling, rigging, and setting bulky equipment.

Read these instructions thoroughly and follow all warnings or cautions included in literature and attached to the unit. Consult local building codes and National Electrical Code (NEC) for special requirements. Recognize safety information.

This is the safety-alert symbol . When you see this symbol on the unit and in instructions or manuals, be alert to the potential for personal injury. Understand these signal words: DANGER, WARNING, and CAUTION. These words are used with the safety-alert symbol. DANGER identifies the most serious hazards which **will** result in severe personal injury or death. WARNING signifies hazards which **could** result in personal injury or death. CAUTION is used to identify unsafe practices which **may** result in minor personal injury or product and property damage. NOTE is used to highlight suggestions which **will** result in enhanced installation, reliability, or operation.



## WARNING

### ELECTRICAL SHOCK HAZARD

Failure to follow this warning could result in personal injury or death.

Before installing, modifying, or servicing system, main electrical disconnect switch must be in the OFF position. There may be more than 1 disconnect switch. Lock out and tag switch with a suitable warning label.



## WARNING



### EXPLOSION HAZARD

Failure to follow this warning could result in death, serious personal injury, and/or property damage.

Never use air or gases containing oxygen for leak testing or operating refrigerant compressors. Pressurized mixtures of air or gases containing oxygen can lead to an explosion.



## CAUTION

### EQUIPMENT DAMAGE HAZARD

Failure to follow this caution may result in equipment damage or improper operation.

Do not bury more than 36 in. (914 mm) of refrigerant pipe in the ground. If any section of pipe is buried, there must be a 6 in. (152 mm) vertical rise to the valve connections on the outdoor units. If more than the recommended length is buried, refrigerant may migrate to the cooler buried section during extended periods of system shutdown. This causes refrigerant slugging and could possibly damage the compressor at start-up.

# PARTS LIST

**Table 1—Parts List**

PART NO.	NAME OF PART
1	AIR OUTLET
2	AIR INLET
3	AIR FILTER
4	ELECTRIC CONTROL CABINET
5	WIRED CONTROLLER
6	DRAIN PIPE (FIELD SUPPLIED)
7	WIRELESS REMOTE

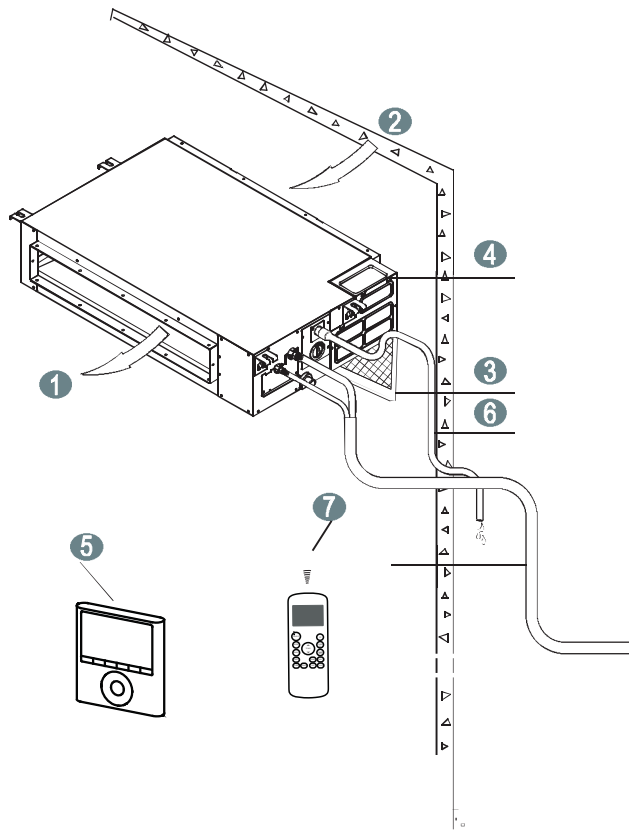

**Fig. 1 – Parts List**

**Notes:**

- If the outdoor unit is higher than the indoor unit, prevent rain from flowing into the indoor unit along the connection pipe by creating a downward arc in the connection pipe before it enters the wall to the indoor unit. This ensures that rain drips from the connection pipe before it enters the wall.
- Piping and the interconnecting wiring are field supplied.
- The illustration above is only a sketch. Different models may be slightly different.
- Filter Standard on units produced after serial number 2815V10001

The following units are covered in these installation instructions.

**Table 2—Indoor Units**

kBTUh	V–Ph–Hz	ID Model No.
9	208/230-1-60	40MBQB09D--3
12	208/230-1-60	40MBQB12D--3
18	208/230-1-60	40MBQB18D--3
24	208/230-1-60	40MBQB24D--3
36	208/230-1-60	40MBQB36D--3
48	208/230-1-60	40MBQB48D--3

## SYSTEM REQUIREMENTS

Allow sufficient space for airflow and servicing unit. See Fig. 3 for minimum required distances between the unit and the walls or ceilings.

### Piping

**IMPORTANT: Both refrigerant lines must be insulated separately.**

- Minimum refrigerant line length between the indoor and outdoor units is 10 ft. (3 m).
- Table 3 lists the pipe sizes for the indoor unit. Refer to the outdoor unit installation instructions for other allowed piping lengths and refrigerant information.

**Table 3—Piping Lengths**

		<b>9K</b>	<b>12K</b>	<b>18K</b>	<b>24K</b>	<b>36K</b>	<b>48K</b>
Gas Pipe (size—connection type)	In (mm)	3/8 (9.52)	1/2 (12.7)	1/2 (12.7)	5/8 (16)	5/8 (16)	5/8 (16)
Liquid Pipe (size—connection type)	In (mm)	1/4 (6.35)	1/4 (6.35)	1/4 (6.35)	3/8 (9.52)	3/8 (9.52)	3/8 (9.52)

## WIRING

All wires must be sized per NEC (National Electrical Code) or CEC (Canadian Electrical Code) and local codes. Use the Electrical Data table MCA (minimum circuit amps) and MOCP (maximum over current protection) to correctly size the wires and the disconnect fuse or breakers respectively.

Per caution note, only stranded copper conductors with a 600 volt rating and double insulated copper wire must be used. The use of BX cable is not recommended.

### Recommended Connection Method for Power and Communication Wiring – Power and Communication Wiring:

The main power is supplied to the outdoor unit. The field supplied 14/3 power/communication wiring from the outdoor unit to the indoor unit consists of four (4) wires and provides the power for the indoor unit. Two wires are high voltage AC power, one is communication wiring and the other is a ground wire.

### Recommended Connection Method for Power and Communication Wiring (To minimize communication wiring interference) Power Wiring:

The main power is supplied to the outdoor unit. The field supplied power wiring from the outdoor unit to the indoor unit consists of three (3) wires and provides the power for the indoor unit. Two wires are high voltage AC power and one is a ground wire.

To minimize voltage drop, the factory recommended wire size is 14/2 stranded with a ground.

### Communication Wiring:

A separate shielded stranded copper conductor only, with a 600 volt rating and double insulated copper wire, must be used as the communication wire from the outdoor unit to the indoor unit. Please use a separate shielded 16GA stranded control wire.



## CAUTION

### EQUIPMENT DAMAGE HAZARD

Failure to follow this caution may result in equipment damage or improper operation.

- Wires should be sized based on NEC and local codes.
- Use copper conductors only with a 600 volt rating and double insulated copper wire.

# DIMENSIONS – INDOOR

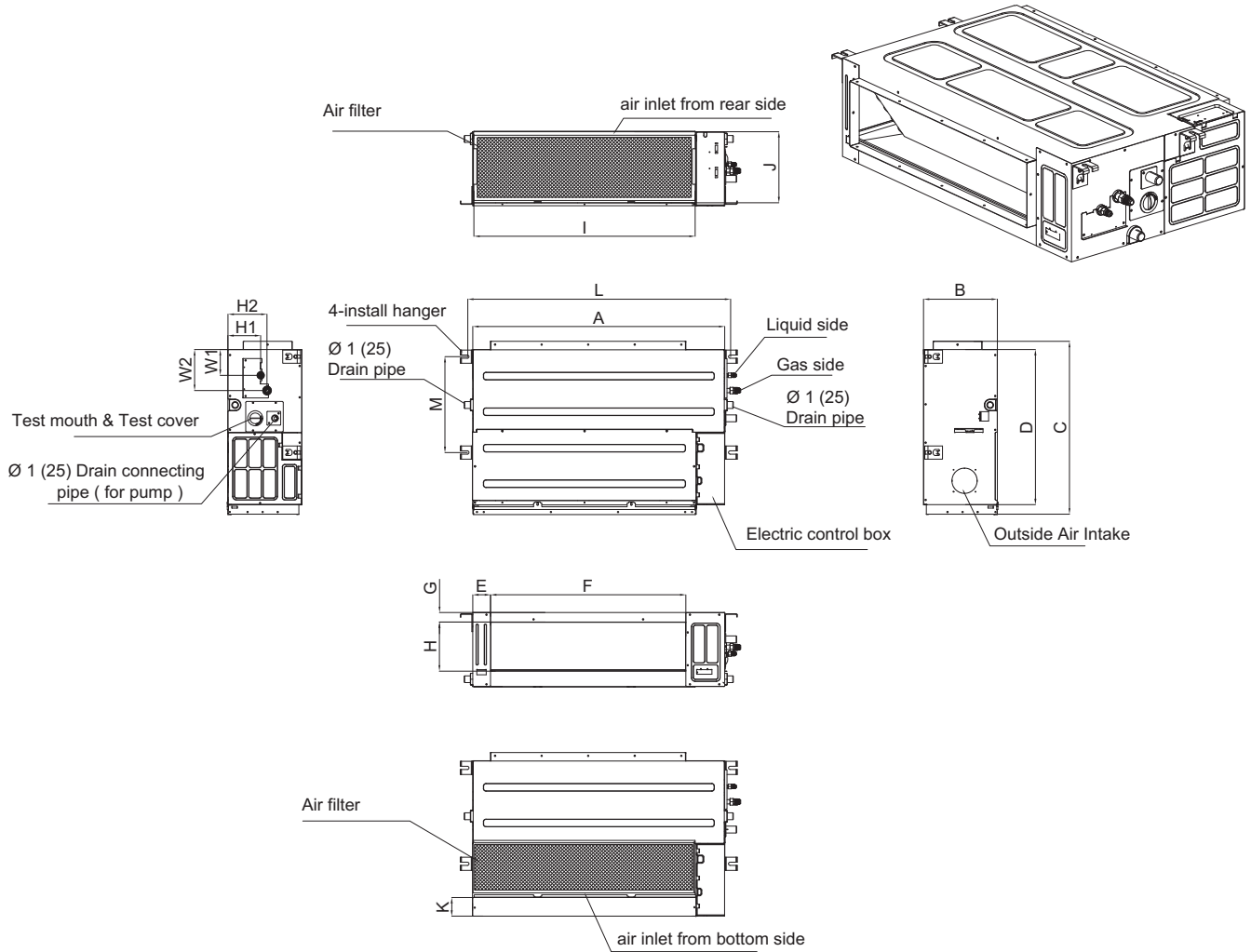

**Fig. 2 – Indoor Unit**

**Table 4—Indoor Unit**

UNIT: in (mm)																		OPERATING WEIGHT lb (kg)
Size	OUTLINE DIMENSIONS				AIR OUTLET OPENING SIZE				AIR RETURN OPENING SIZE			HANGER BRACKERS		REFRIGERANT PIPE LOCATIONS				
	A	B	C	D	E	F	G	H	I	J	K	L	M	H1	H2	W1	W2	
9	27.6 (700)	8.2 (210)	25 (635)	22.4 (570)	2.5 (65)	19.4 (493)	1.3 (35)	4.6 (119)	23.4 (595)	7.8 (200)	3.1 (80)	29.1 (740)	13.8 (350)	4.7 (120)	5.6 (143)	3.7 (95)	5.9 (150)	39.9 (18.1)
12	27.6 (700)	8.2 (210)	25 (635)	22.4 (570)	2.5 (65)	19.4 (493)	1.3 (35)	4.6 (119)	23.4 (595)	7.8 (200)	3.1 (80)	29.1 (740)	13.8 (350)	4.7 (120)	5.6 (143)	3.7 (95)	5.9 (150)	39.9 (18.1)
18	36.2 (920)	8.2 (210)	25 (635)	22.4 (570)	2.5 (65)	28.07 (713)	1.3 (35)	4.6 (119)	32.0 (815)	7.8 (200)	3.1 (80)	37.8 (960)	13.8 (350)	4.7 (120)	5.6 (143)	3.7 (95)	5.9 (150)	50.7 (23)
24	36.2 (920)	10.6 (270)	25 (635)	22.4 (570)	2.5 (65)	28.07 (713)	1.3 (35)	7.0 (179)	32.0 (815)	10.2 (260)	0.7 (20)	37.8 (960)	13.8 (350)	4.7 (120)	5.6 (143)	3.7 (95)	5.9 (150)	57.3 (26)
36	44.8 (1140)	10.6 (270)	30.5 (775)	27.9 (710)	2.5 (65)	36.7 (933)	1.3 (35)	7.0 (179)	40.7 (1035)	10.2 (260)	0.7 (20)	46.5 (1180)	19.3 (490)	4.7 (120)	5.6 (143)	3.7 (95)	5.9 (150)	77.1 (35)
48	47.2 (1200)	11.8 (300)	34.1 (865)	31.4 (800)	3.1 (80)	38.1 (968)	1.5 (40)	8.0 (204)	43.0 (1094)	11.3 (288)	1.7 (45)	48.8 (1240)	19.7 (500)	6.9 (175)	7.8 (198)	6.1 (155)	8.3 (210)	99.2 (45)

# CLEARANCES – INDOOR

## INSTALLATION PLACE

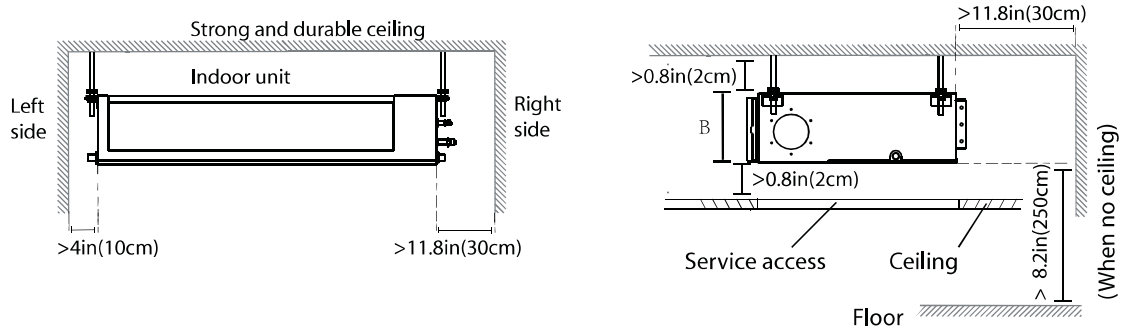

## MAINTENANCE SPACE

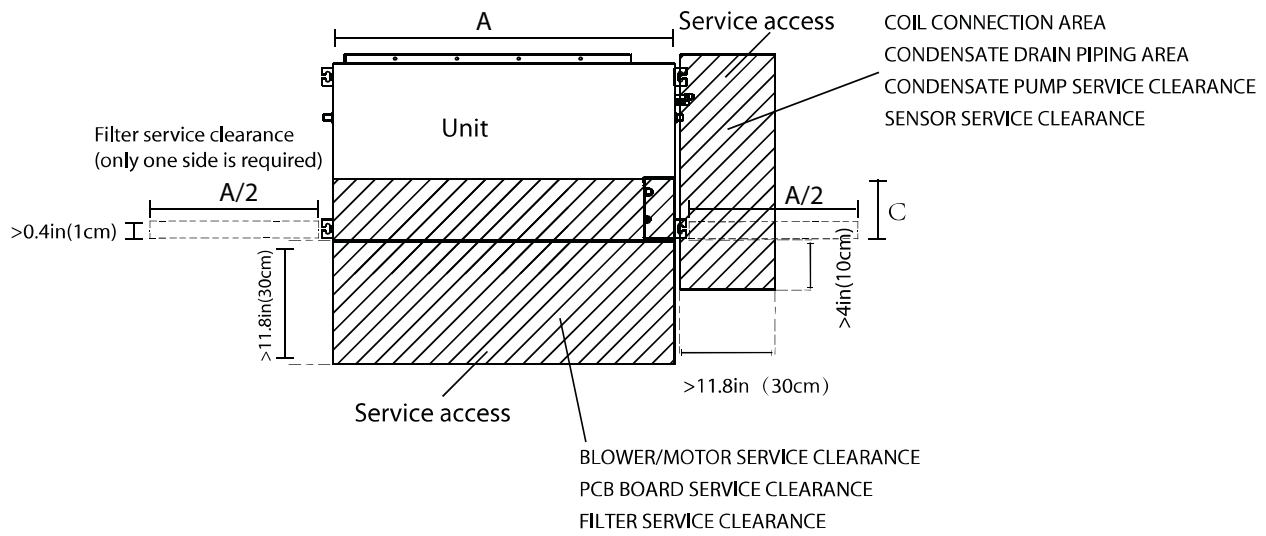

**Fig. 3 – Indoor Unit Clearances**

**Table 5—Indoor Unit Clearance**

Capacity (Kbtu)	A	B	C
9K	27.56 in. (70cm)	8.27 in. (21cm)	11.81 in. (30cm)
12K	27.56 in. (70cm)	8.27 in. (21cm)	11.81 in. (30cm)
18K	36.22 in. (92cm)	8.27 in. (21cm)	11.81 in. (30cm)
24K	36.22 in. (92cm)	10.63 in. (27cm)	11.81 in. (30cm)
36K	44.88 in. (114cm)	10.63 in. (27cm)	11.81 in. (30cm)
48K	47.24 in. (120cm)	11.81 in. (30cm)	15.75 in. (40cm)

## INSTALLATION LOCATION REQUIREMENTS

### Indoor Unit

- Confirm that the ceiling is able to support the weight of the unit.
- There should be enough room within the false ceiling for installation and maintenance.
- The false ceiling should be horizontal and leveled.
- Install the unit in a location within the room that allows uniform air flow in all directions.
- Do not install the indoor units near a direct source of heat such as direct sunlight or a heating appliance.
- A location which provides appropriate clearances.
- Ensure the hanger is strong enough to withstand the unit's weight.

### Indoor and Outdoor Units (General)

- Ensure space is left for access for maintenance.
- Location should be far away from where there is a heat source, leakage of any inflammable, explosive substances, or smog.
- All wiring and refrigerant lines must be at least 3 ft. (1m) away from sources of electromagnetic interference (such as televisions, radios, etc.). Interference is still possible even if this distance is maintained.
- Do not install the indoor or outdoor units in a location with special environmental conditions. For those applications, contact your Ductless representative.

## INDOOR UNIT INSTALLATION

### INDOOR DUCTED UNIT INSTALLATION



## CAUTION

Be sure that the ceiling grid is supported separately from the unit.

The ceiling grid must not be supported by any part of the unit or any associated wiring or piping work.

### MOUNTING THE UNIT

1. **INSTALLING HANGER BOLTS** – Install the hanger bolts at the locations (see Fig. 4, top view). Use  $\text{Ø}10 / \text{Ø}0.394\text{in}$  all-threaded rod.

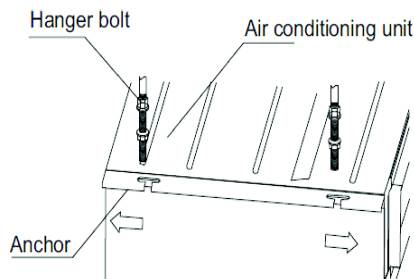

Fig. 4 – Install the Hanger Bolts

A150664

2. The unit can now be lifted on to the hanging rods for mounting.
3. Use rods and fasteners to suspend the unit at the factory provided mounting holes.
4. Adjust the unit's height until the bottom is level with the false ceiling, with adequate space to provide enough pitch for the drain.

5. Secure the unit in position with lock nuts and washers on both sides of the mounting bracket. Ensure the threaded rod does not extend more than 2 in. below the mounting brackets (see Fig. 5).

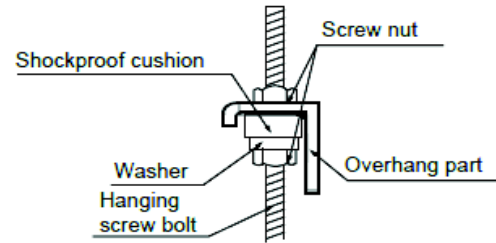

Fig. 5 – Secure the Unit

A150665

### RETURN AIR ARRANGEMENT

Based on the return air arrangement requirement in the field, the unit can be modified from the rear return to the bottom return.

1. Remove the return air duct collar/filter rack and plenum bottom panel.

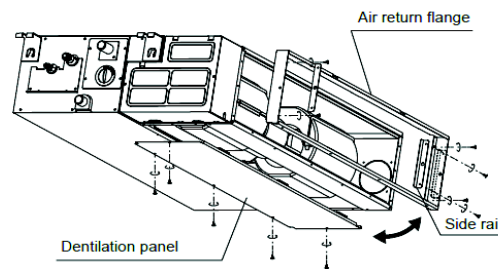

Fig. 6 – Remove the Return Air Duct Collar

A150666

2. Install the Seal Sponge on the bottom inlet.

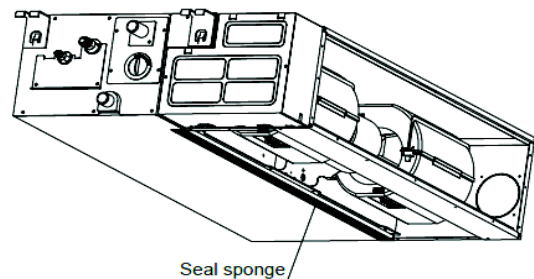

Fig. 7 – Install the Seal Sponge

A150667

3. Swap the position to change the rear return to bottom return arrangement installing the Air Return flange and the filters.

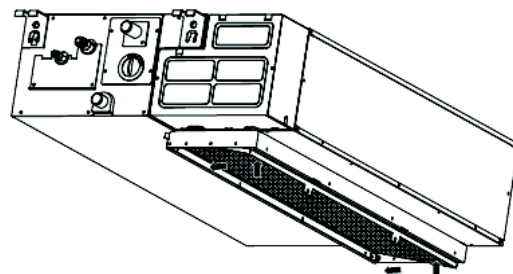
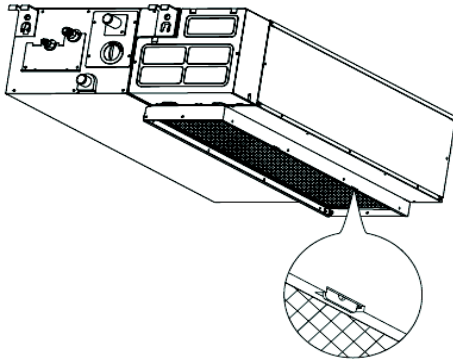

Fig. 8 – Change the Rear Return

A150668

4. Install the filter brackets to lock the filter in place.



**Fig. 9 – Install the Filter Brackets**

A150670

**INSTALLING DUCTWORK**

Connect the return and supply ducts to the duct collars provided on the unit. Adequate distance between the return and supply diffusers should be maintained to avoid short circulation of air within the space.

The filter is located on the return side of the unit, on the rear or bottom depending on the return air inlet arrangement.

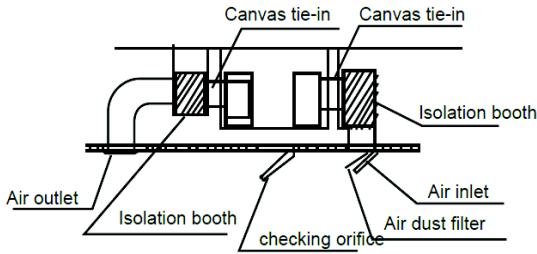

**Fig. 10 – Installing Duct**

A150671

**CONDENSATE PIPE INSTALLATION**

The unit (starting with serial number 0116V10001) is supplied with a 1 in ID drain connection to connect 1in OD copper or PVC drain piping. When installing condensate piping, follow these recommendations:

- Install drains to meet local sanitation codes.
- The Ducted Style Indoor unit is supplied with a pump that is capable of lifting water 29.5in (750mm).
- The highest point in the condensate piping should be as close to the unit as possible (see Fig. 11).
- Condensate piping should slope downward in the direction of condensate flow, with a minimum gradient of 1/50.
- When multiple units are connected to a common condensate drain, ensure that the drain is large enough to accommodate the volume of condensate from all units. It is also recommended to have an air vent in the condensate piping to prevent air lock.
- Condensate piping must not be installed where it may be exposed to freezing temperatures.

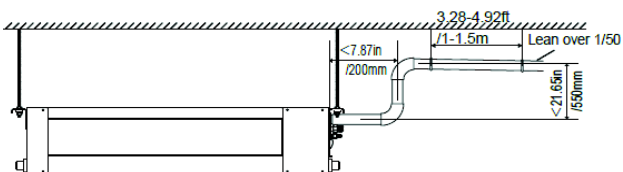

**Fig. 11 – Condensate piping with a pump**

A150672

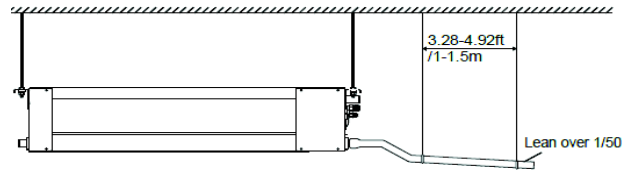

**Fig. 12 – Condensate piping without a pump**

A150673

**DRAIN PUMP AND DRAINAGE TEST**

Follow these steps to perform the test:

1. Remove the test cover by rotating it counter-clockwise as shown in Fig. 13.
2. Using a piece of tubing or pipe, fill the drain pump reservoir with 70 oz. of water (see Fig. 14).
3. Turn the unit ON in cooling mode. The pump comes on. Watch the end of the drain pipe for any water. It may take some time for the water to travel, depending on the length of the drain pipe.
4. During this test, check all bends or joints for leakage.

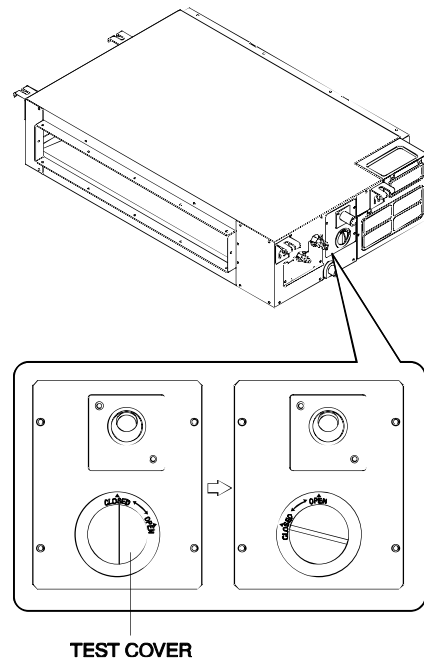

**Fig. 13 – Check the Bends and Joints for Leakage**

A150674

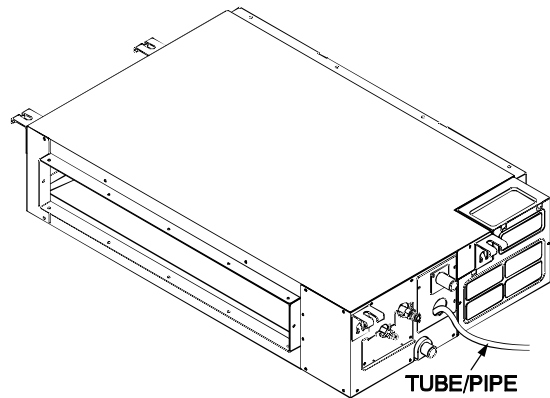
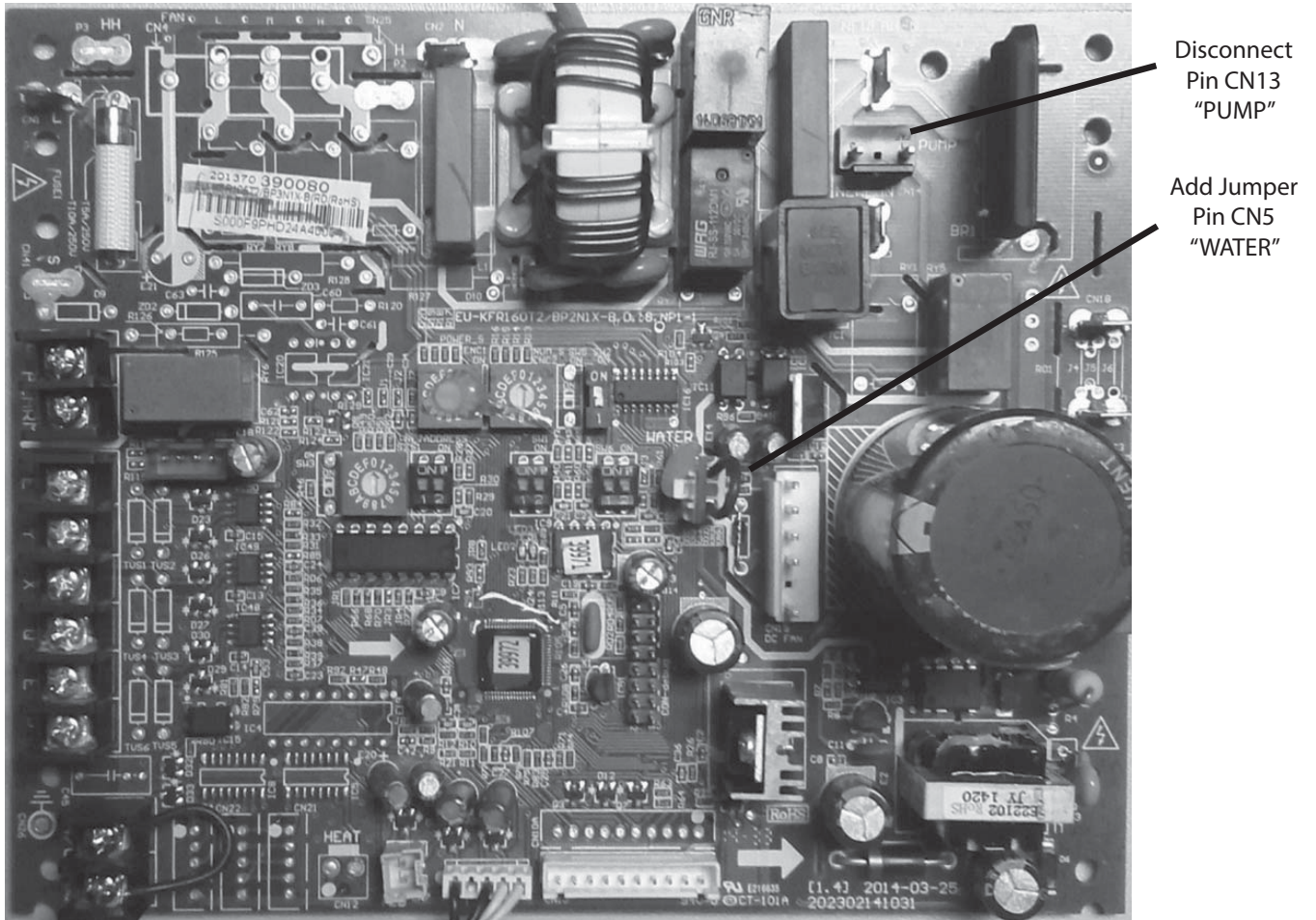

**Fig. 14 – Tube/Pipe Insert**

A150675



**NOTE:** In case the factory installed drain pump has to be disabled, place a Jumper (field supplied) on the Pin CN5 "WATER" connector and disconnect the Pin CN13 "PUMP" (see Fig 15).





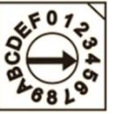

**Fig. 15 – Pin CN5**

# FAN PERFORMANCES AT VARYING STATIC PRESSURES (DUCTED UNITS)

The static pressure of the indoor unit has been set in the factory according to Table 6.

**Table 6—Static Pressure Switch**

						Static Pressure Range In. WG (Pa)
<b>Size</b>	0	1	2	3	4	
<b>9 &amp; 12</b>	0.02 (5)	0.04 (10)	0.08 (20)	0.12 (30)	0.16 (40)	0–0.18 (0–45)
<b>18</b>	0.04 (10)	0.10 (25)	0.14 (35)	0.18 (45)	0.22 (55)	0–0.28 (0–70)
<b>24</b>	0.04 (10)	0.10 (25)	0.16 (40)	0.22 (55)	0.28 (70)	0–0.40 (0–100)
<b>36 &amp; 48</b>	0.08 (20)	0.14 (35)	0.20 (50)	0.26 (65)	0.32 (80)	0–0.40 (0–100)
<b>Factory Setting</b>	✓					

**Table 7—Airflow at Different Speeds**

SYSTEM SIZE		9K	12K	18K	24K	36K	48K
<b>High</b>	CFM	335	370	520	820	1120	1470
	CMH	570	629	884	1394	1904	2499
<b>Medium</b>	CFM	290	320	430	620	940	1180
	CMH	493	544	731	1054	1598	2006
<b>Low</b>	CFM	240	260	360	520	680	940
	CMH	408	442	612	884	1156	1598

# STATIC PRESSURE CURVES SIZE 9

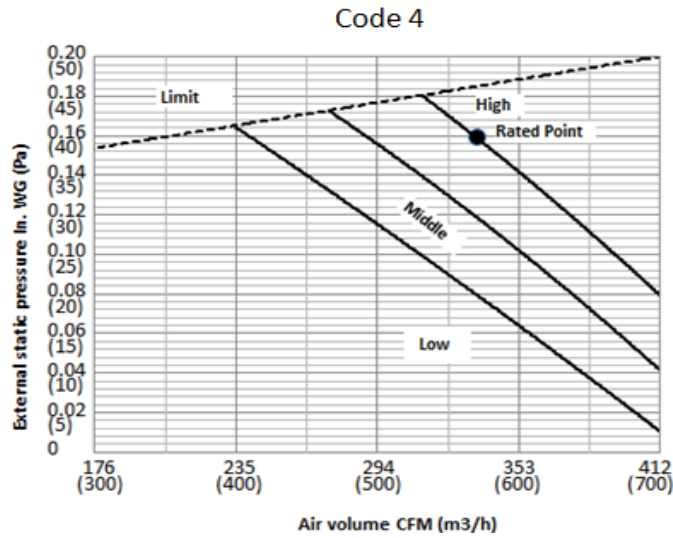
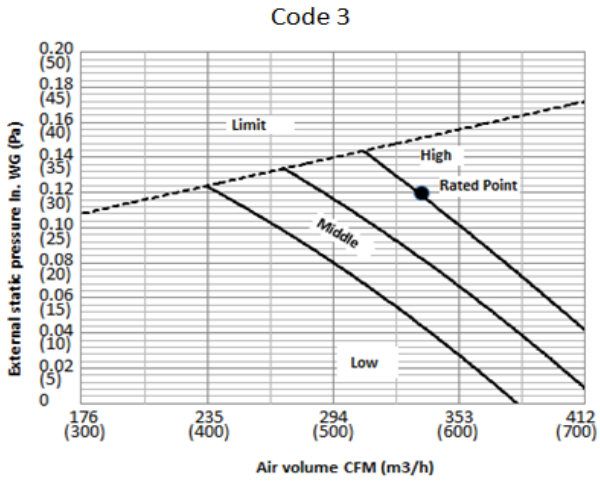
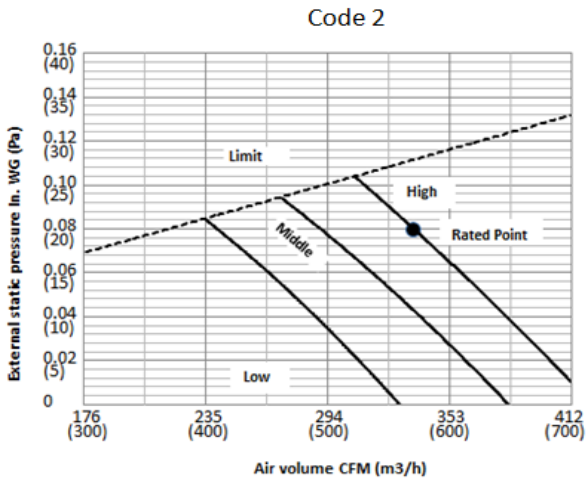
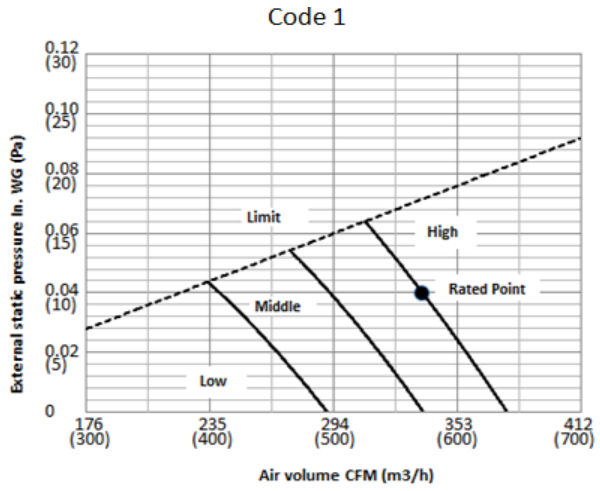
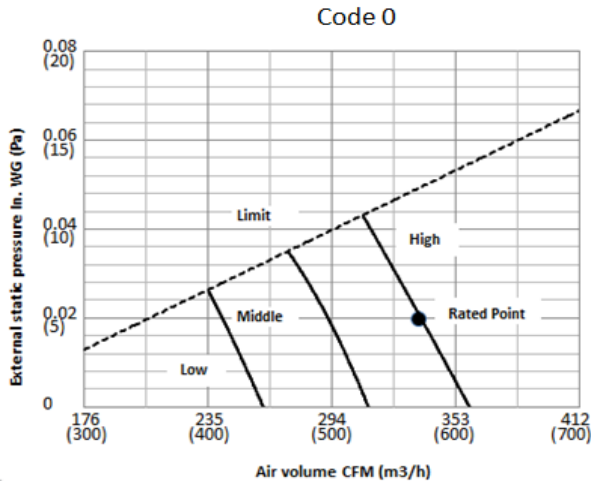

**STATIC PRESSURE CURVES SIZE 12**

**Code 0**

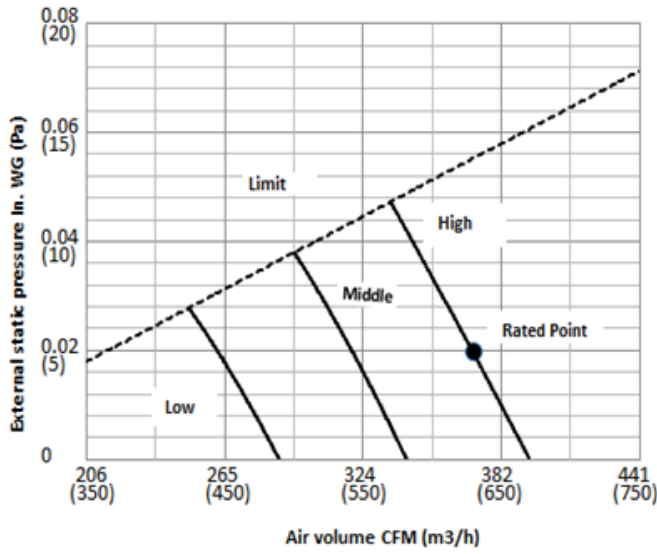

**Code 1**

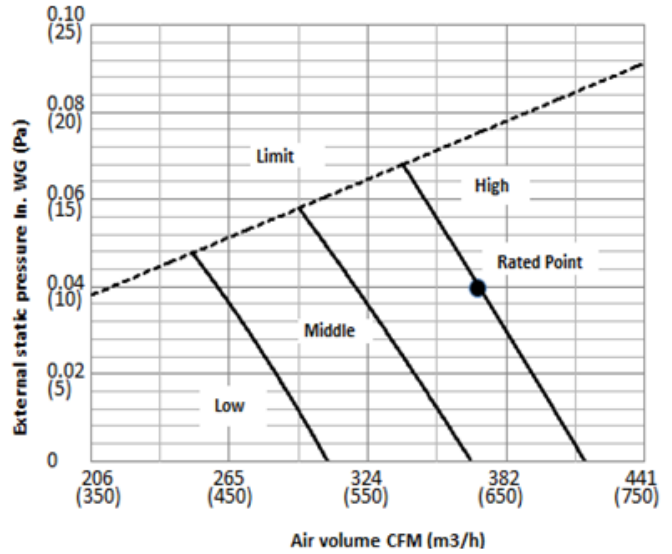

**Code 2**

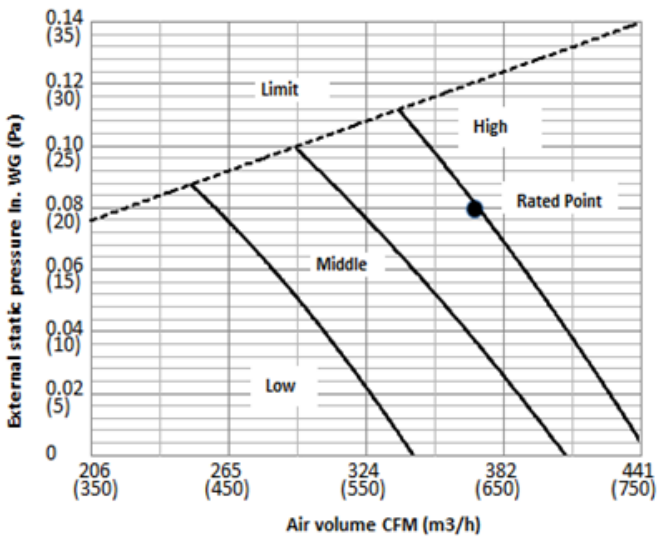

**Code 3**

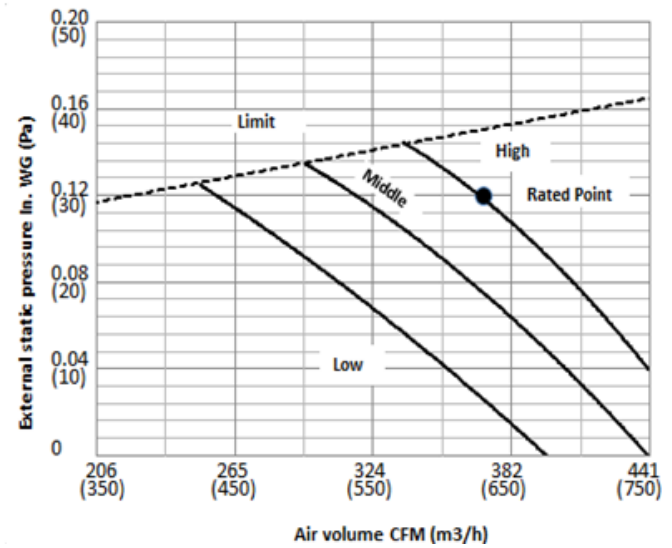

**Code 4**

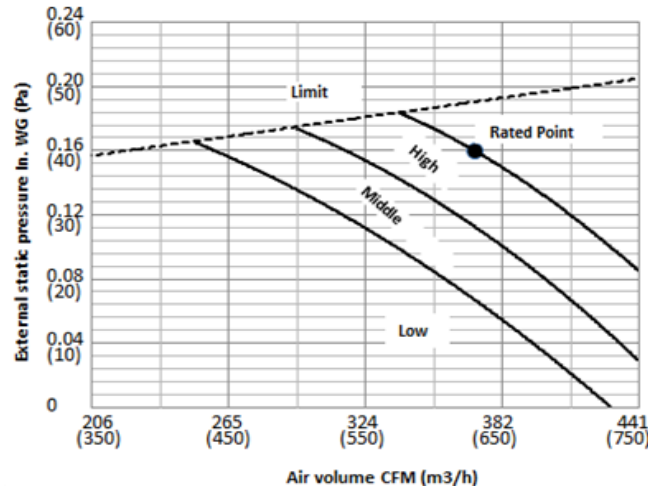

**STATIC PRESSURE CURVES SIZE 18**

**Code 0**

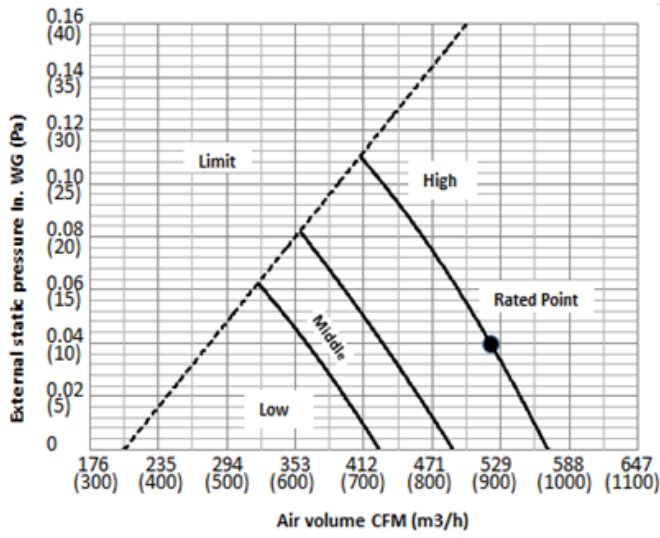

**Code 1**

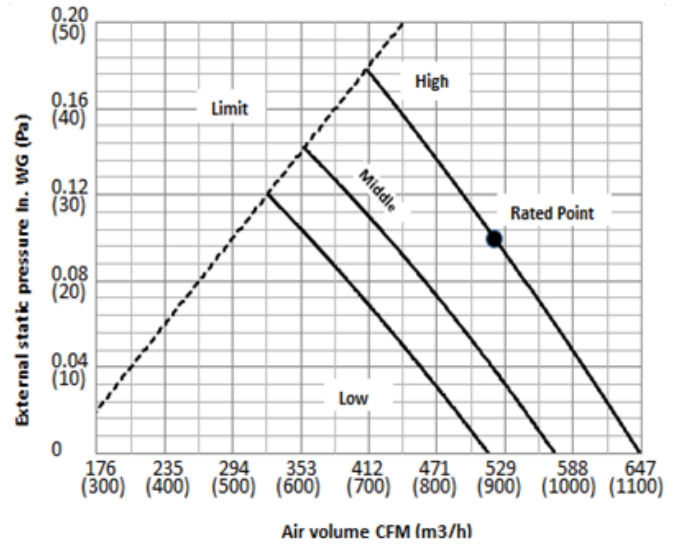

**Code 2**

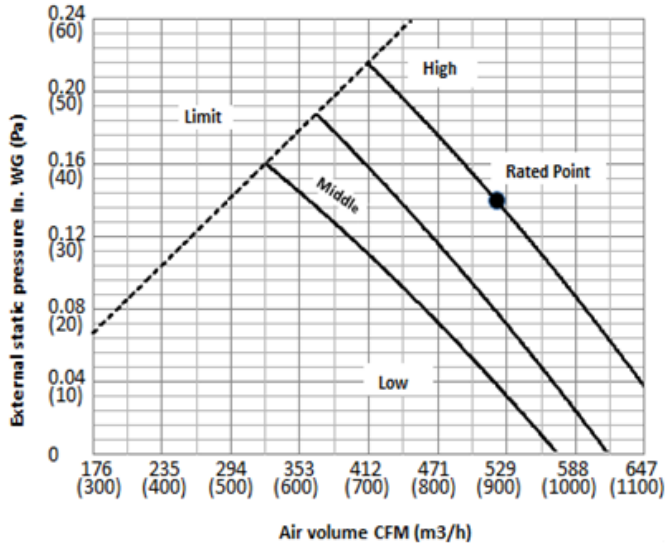

**Code 3**

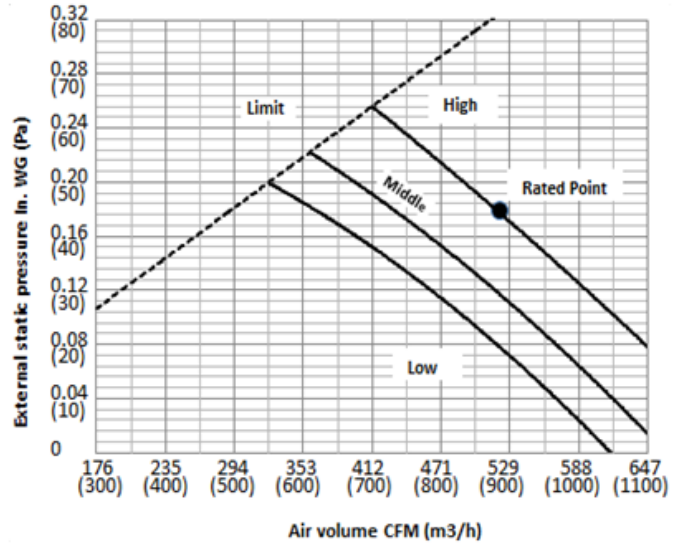

**Code 4**

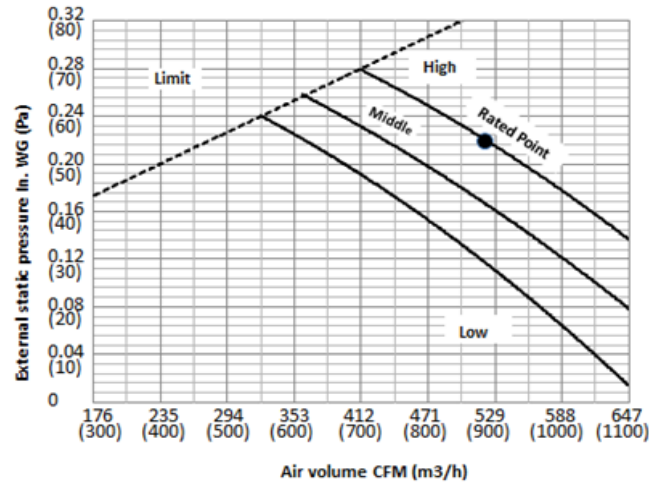

**STATIC PRESSURE CURVES SIZE 24**

**Code 0**

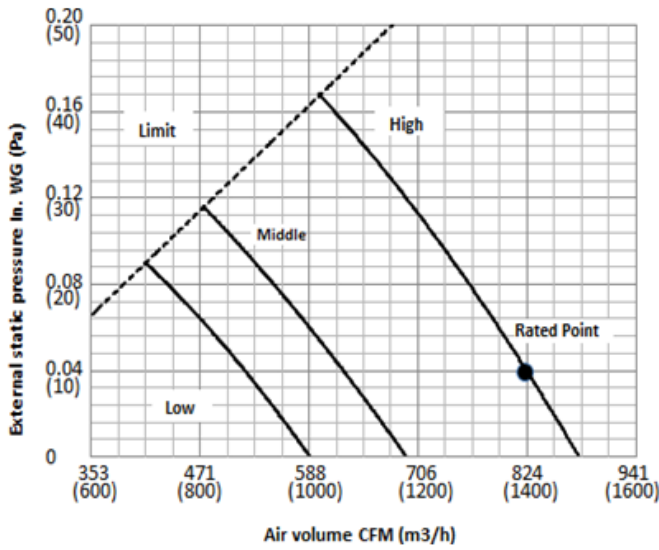

**Code 1**

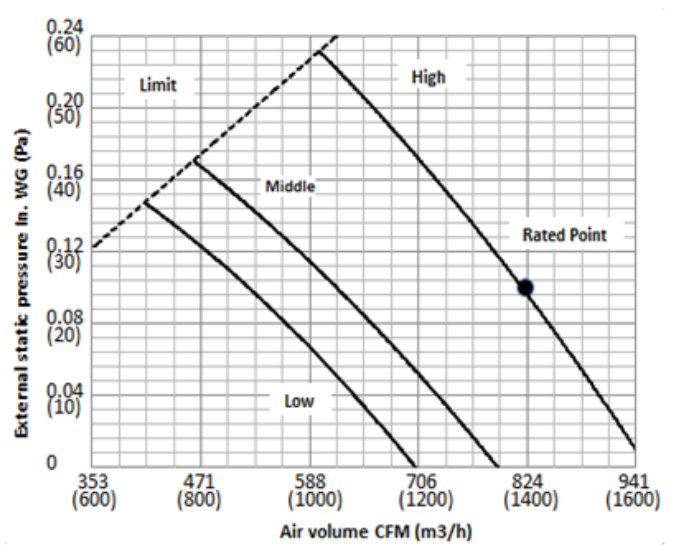

**Code 2**

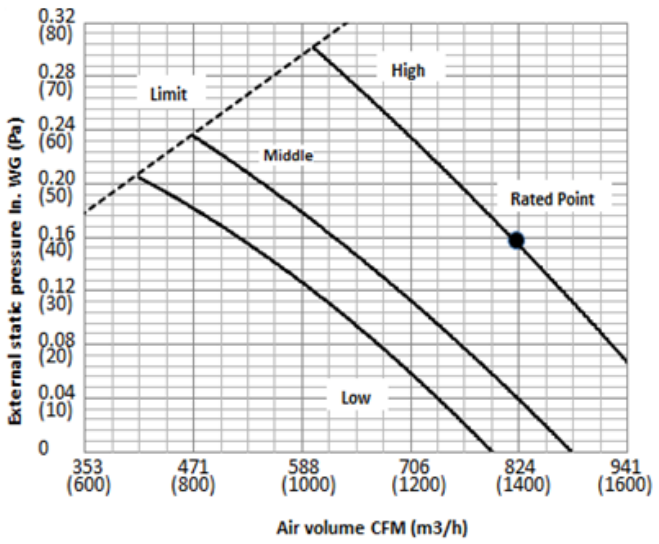

**Code 3**

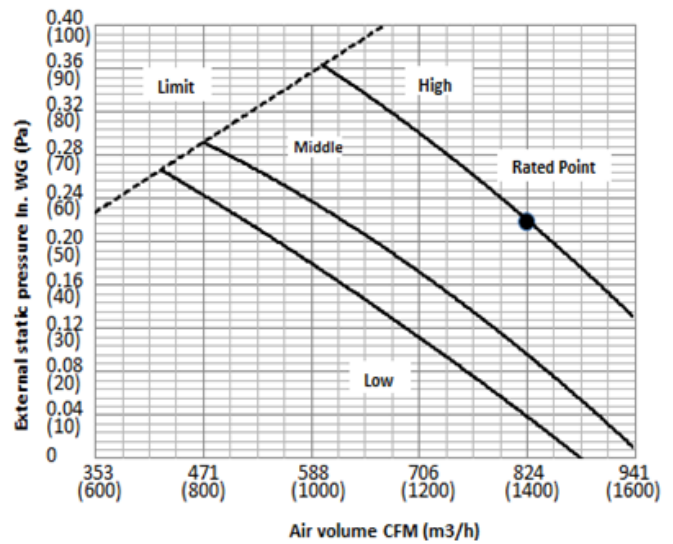

**Code 4**

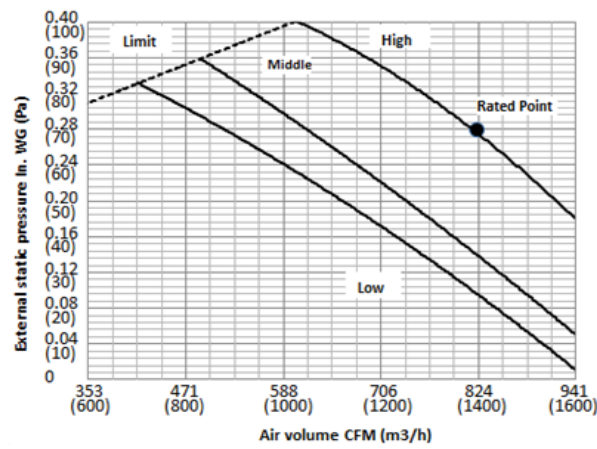

**STATIC PRESSURE CURVES SIZE 36**

**Code 0**

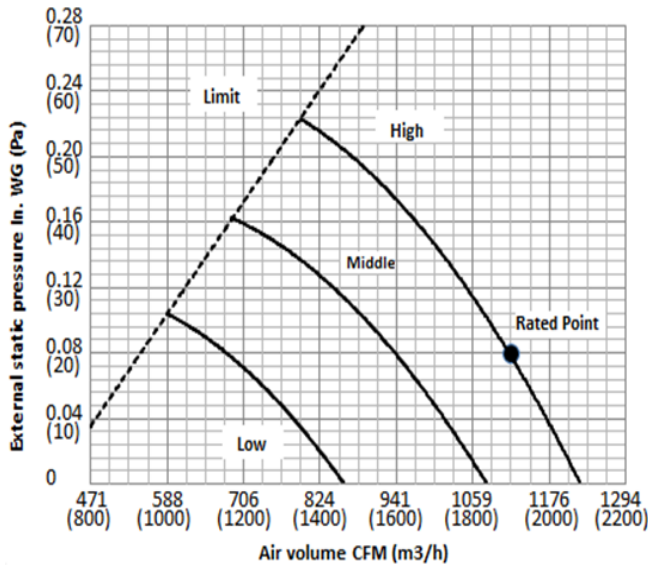

**Code 1**

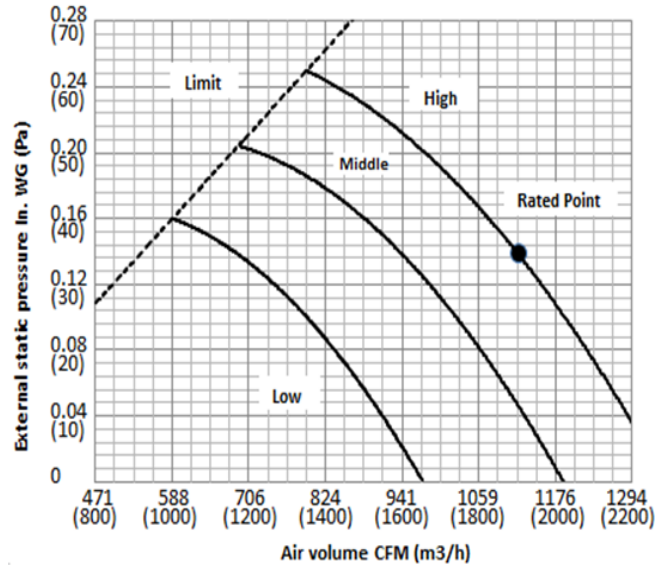

**Code 2**

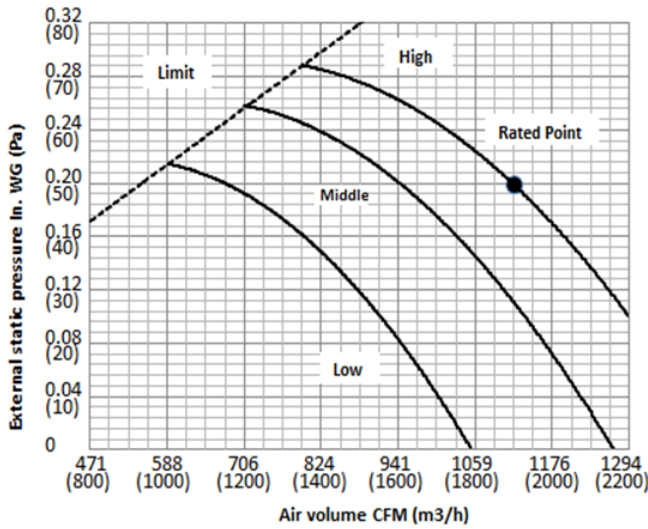

**Code 3**

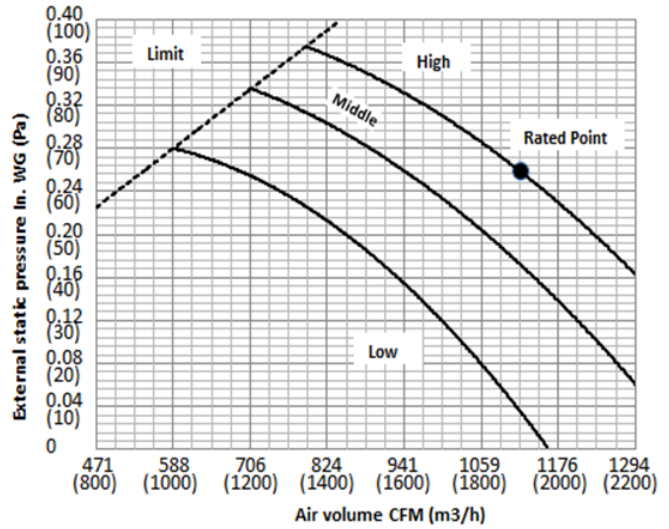

**Code 4**

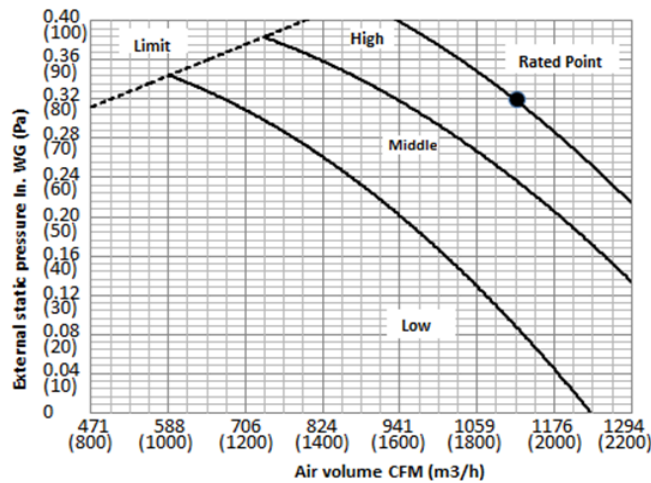

**STATIC PRESSURE CURVES SIZE 48**

**Code 0**

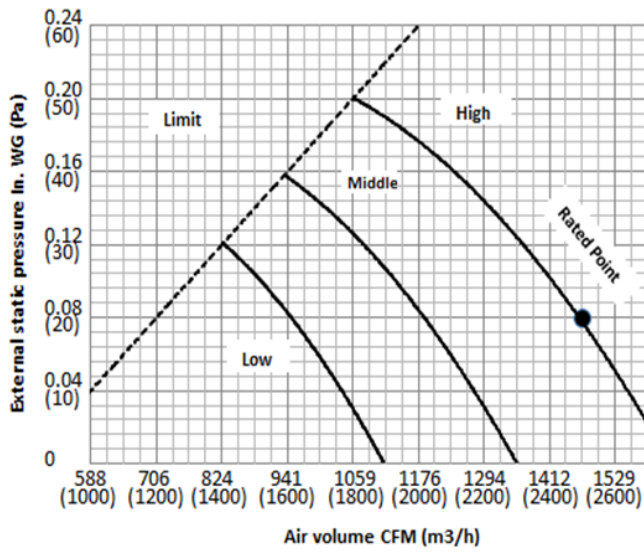

**Code 1**

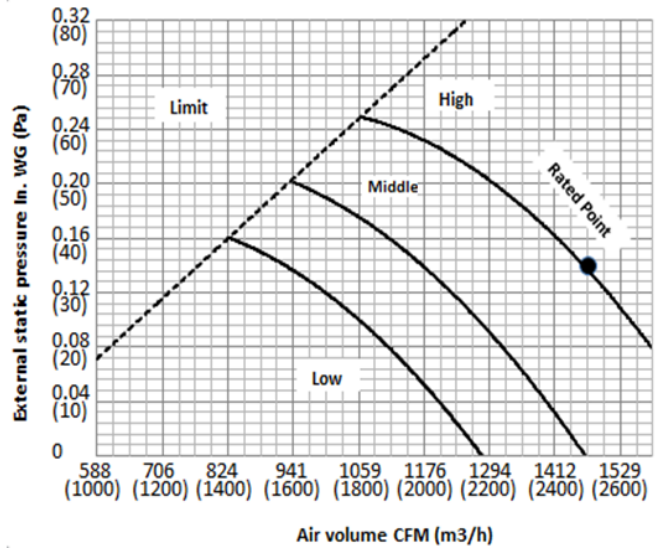

**Code 2**

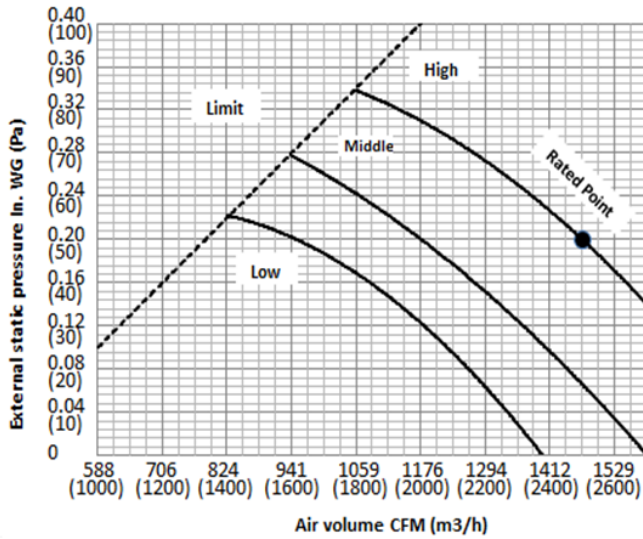

**Code 3**

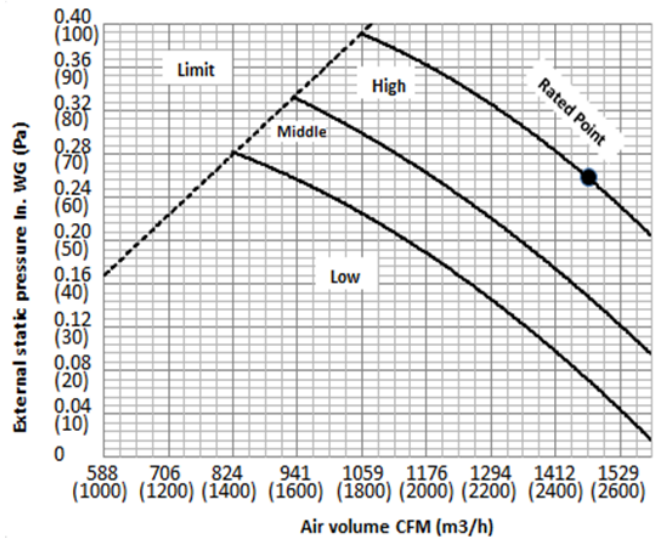

**Code 4**

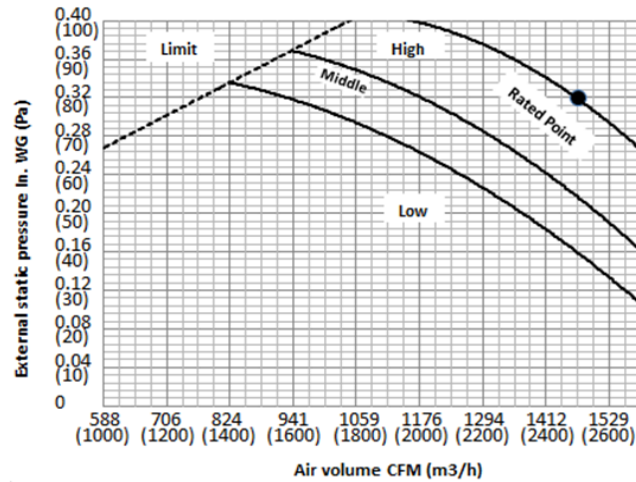



# ELECTRICAL DATA

**Table 8—Electrical Data**

UNIT SIZE	INDOOR FAN				MAX FUSE CB AMP
	V-PH-HZ	FLA	HP	W	
9	208-230/1/60	1.03	0.07	55	Refer to outdoor unit installation instructions – Indoor unit powered by the outdoor unit
12		1.03	0.07	55	
18		0.83	0.12	90	
24		0.83	0.12	90	
36		1.26	0.20	150	
48		2.23	0.32	240	

**LEGEND**

FLA – Full Load Amps

## CONNECTION DIAGRAMS

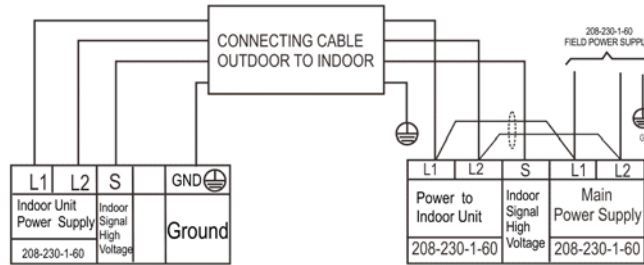

**Fig. 16 – Connection Diagrams 9, 12, 18 and 24**

A150687

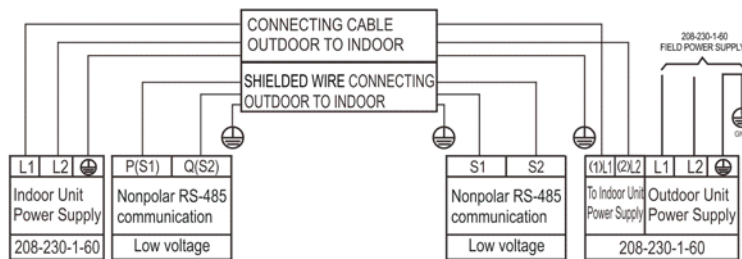

**Fig. 17 – Connection Diagrams 36 and 48**

A150688

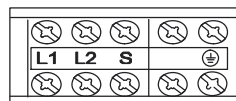

**Fig. 18 – Control and Power Wiring on Indoor Unit**

A150641

**Notes:**

1. Do not use thermostat wire for any connection between indoor and outdoor units.
2. All connections between indoor and outdoor units must be as shown. **The connections are sensitive to polarity and will result in a fault code.**

## INSTALL ALL POWER, INTERCONNECTING WIRING, AND PIPING TO INDOOR UNIT

1. Run interconnecting piping and wiring from the outdoor unit to the indoor unit.
2. Connect wiring from outdoor unit per the connection diagram (see Fig. 16 and Fig. 17).
3. Replace field wiring cover of the indoor unit.
4. Connect refrigerant piping and drain line outside of indoor unit. Complete pipe insulation at flare connection then fasten piping and wiring to the wall as required. Completely seal the hole in the wall.
5. Piping:
  - a. Cut the pipe, with a pipe cutter, at 90 degrees (see Fig. 19).
  - b. Remove the service connection, if provided with the unit.

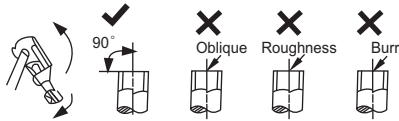

**Fig. 19 – Pipe Cutting**

A150767

- c. Remove all the burrs from the cut cross section of the pipe avoiding any burrs inside the tubes.
- d. Remove the flare nuts attached to the indoor and outdoor units.
- e. Install the correct size flare nut onto the tubing and make the flare connection. Refer to Table 9 for the flare nut spaces.

**Table 9—Flare Nut Spacing**

OUTER DIAM. (mm)	A (mm)	
	Max.	Min.
Ø 1/4" (6.35)	0.05 (1.3)	0.03 (0.7)
Ø 3/8" (9.52)	0.06 (1.6)	0.04 (1.0)
Ø 1/2" (12.7)	0.07 (1.8)	0.04 (1.0)
Ø 5/8" (15.88)	0.09 (2.2)	0.08 (2.0)

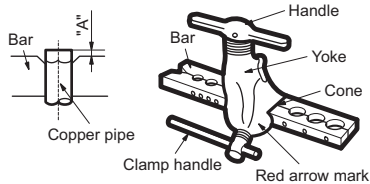

**Fig. 20 – Flare Nut Spacing**

A150768

- f. Apply a small amount of refrigerant oil to the flare connection on the tubing.
- g. Align center of the pipes and/or service valve.

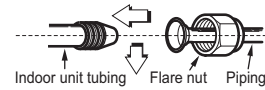

A150769

**Fig. 21 – Align Pipe Center**

- h. Connect both the liquid and gas piping to the indoor unit
- i. Tighten the flare nut using a torque wrench as specified in Table 10.

**Table 10—Tightening Torque**

PIPE DIAMETER INCH (mm)	TIGHTENING TORQUE	
	Ft-lb	N-m
Ø1/4" (6.35)	10 to 13	13.6 to 17.6
Ø3/8" (9.52)	24 to 31	32.5 to 42.0
Ø1/2" (12.7)	37 to 46	50.1 to 62.3
Ø5/8" (15.88)	50 to 60	67.7 to 81.3

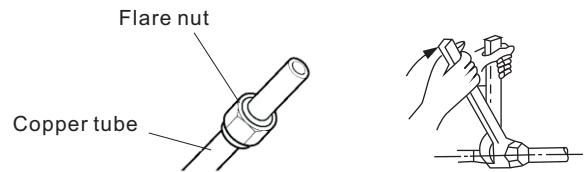

A150770

**Fig. 22 – Tighten the Flare Nut**

6. Connect the drain line. The drain line must not have a trap anywhere in its length, must pitch downwards, and must be insulated up to the outside wall.

**NOTE:** For applications where gravity cannot be used for drainage, a condensate pump accessory is available. Consult the condensate pump Installation Instructions for more information.

## WIRELESS REMOTE CONTROL INSTALLATION

### Mounting Bracket (if installed on the wall)

1. Use the two screws supplied with control to attach the mounting bracket to the wall in a location selected by customer and within operating range.
2. Install batteries in the remote control.
3. Place the remote control into the remote control mounting bracket.
4. For remote control operation, refer to the unit owner's manual.

**NOTE:** If a wireless remote controller is used, relocate the infrared (IR) receiver within line of sight of remote location using the 6 ft. (1.82 m) cable included. The factory location of the IR receiver is inside the control box (see Fig. 23).

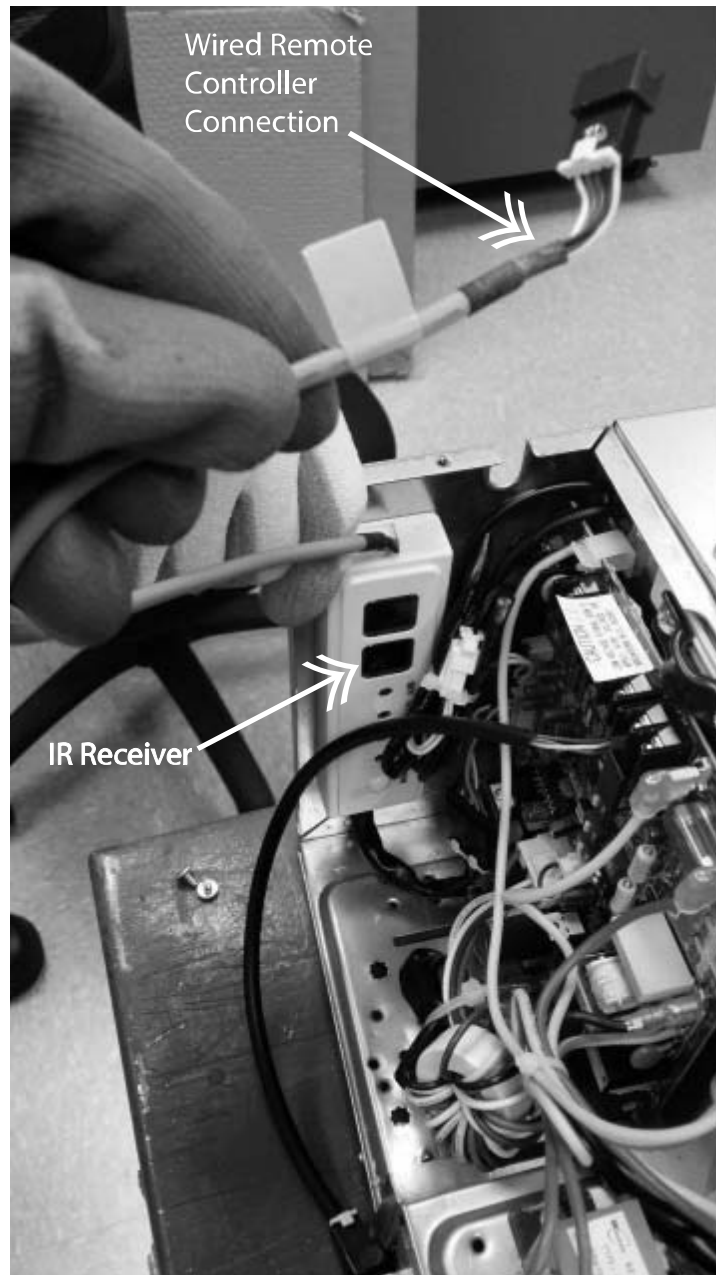

**Fig. 23 – Control Box**

A150642

## WIRED REMOTE CONTROLLER INSTALLATION

To connect the wired remote controller (Timer Function KSACN0101AAA) to the indoor unit, use 5-core shielded cable and 5-pin connector from IR receiver located in the control box (see Fig 23).

To connect the wired remote controller (7 Day Programmable KSACN0501AAA) to the indoor unit, use 4-pin connector CN40 located in the control box. For setup instructions, refer to the controller installation manual.

# ⚠ CAUTION

## UNIT DAMAGE HAZARD

Failure to follow this caution may result in equipment damage or improper operation.

Never use the system compressor as a vacuum pump.

Refrigerant tubes and indoor coil should be evacuated using the recommended deep vacuum method of 500 microns. The alternate triple evacuation method may be used if the procedure outlined below is followed. Always break a vacuum with dry nitrogen.

### Final Tubing Check

**IMPORTANT:** Check to be certain factory tubing on both indoor and outdoor unit has not shifted during shipment. Ensure tubes are not rubbing against each other or any sheet metal. Pay close attention to feeder tubes, making sure wire ties on feeder tubes are secure and tight.

## START-UP

### Test Operation

Perform test operation after completing gas leak and electrical safety check (see Fig. 24).

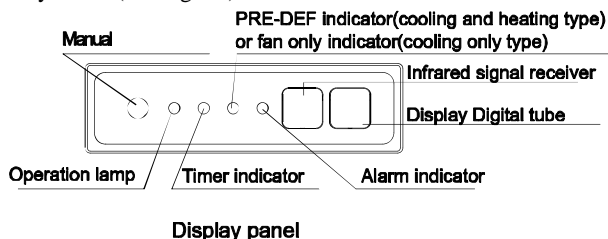

A150643

**Fig. 24 — Test Operation**

1. Press the **MANUAL** button on the IR receiver located in the control box to begin testing.

**NOTE:** A protection feature prevents air conditioner from being activated for approximately 3 to 4 minutes.

2. Push **MODE**, select **COOLING, HEATING, FAN** mode to check if all functions work correctly.
3. To run the test using the manual button in the indoor unit:
  - (1.) Open front panel of the indoor unit;
  - (2.) Push the manual switch once to energize the unit.  
The set conditions of manual operation are as follows:
    - Preset set point: 76°F (24°C)
    - Fan speed: **AUTO**
    - Discharge air direction: Pre-set position based on operation in “Cool” or “Heat” mode.
4. Be sure to set the manual switch to “OFF” (by pushing it twice again) after finishing the test operation.

## SYSTEM CHECKS

1. Conceal the tubing where possible.
2. Make sure that the drain tube slopes downward along its entire length.
3. Ensure all tubing and connections are properly insulated.
4. Fasten tubes to the outside wall, when possible.
5. Seal the hole through which the cables and tubing pass.

## INDOOR UNIT

1. Do all remote control buttons function properly?
2. Do the display panel lights work properly?
3. Does the air deflection louver function properly?
4. Does the drain work?

### **Explain Following Items To Customer (with the aid of the Owner's Manual):**

1. How to turn air conditioner on and off; selecting **COOLING, HEATING** and other operating modes; setting a desired temperature; setting the timer to automatically start and stop air conditioner operation; and all other features of the remote control and display panel.
2. How to remove and clean the air filter.
3. How to set air deflection louver.
4. Explain care and maintenance.
5. Present the owner's manual and installation instructions to customer.

## TROUBLESHOOTING

For ease of service, the systems are equipped with diagnostic code display LEDs on both the indoor and outdoor units. The outdoor diagnostic display consists of two LEDs (Red and Green) on the outdoor unit board and is limited to a few errors.

The indoor diagnostic display is a combination of flashing LEDs on the display panel (IR Receiver). If possible, always check the diagnostic codes displayed on the indoor unit first.

The diagnostic codes displayed in the indoor and outdoor units are listed in Table 11.

### INDOOR UNIT DIAGNOSTIC GUIDES

**Table 11—Indoor Unit Diagnostic Guides**

OPERATION LAMP	TIMER LAMP	DISPLAY	LED STATUS
★ 1 time	X	E0	Indoor unit EEPROM parameter error
★ 2 times	X	E1	Indoor / outdoor units communication error
★ 3 times	X	E2	Zero-crossing signal detection error
★ 4 times	X	E3	Indoor fan speed has been out of control
★ 5 times	X	E4	Indoor room temperature sensor T1 open circuit or short circuit
★ 6 times	X	E5	Evaporator coil temperature sensor T2 open circuit or short circuit
★ 7 times	X	EC	Refrigerant leakage detection
★ 2 times	O	F1	Outdoor ambient temperature sensor T4 open circuit or short circuit
★ 3 times	O	F2	Condenser coil temperature sensor T3 open circuit or short circuit
★ 4 times	O	F3	Compressor discharge temperature sensor T5 open circuit or short circuit
★ 5 times	O	F4	Outdoor unit EEPROM parameter error
★ 6 times	O	F5	Outdoor fan speed has been out of control
★ 1 time	★	P0	IPM malfunction or IGBT over—strong current protection
★ 2 times	★	P1	Over voltage or over low voltage protection
★ 3 times	★	P2	High temperature protection of compressor top diagnosis and solution (only for 9k, 12k models)
★ 5 times	★	P4	Inverter compressor drive error

O(light) X(off) ★(flash)

For additional diagnostic information, refer to the Service Manual.

