



Air Knight[®]



AIR PURIFICATION SYSTEM



OWNER'S MANUAL

Air Knight 5"

#TT-AK245-V2

Air Knight 9"

#TT-AK249-V2

www.airknightiaq.com





CONGRATULATIONS

on your purchase of the Air Knight in-duct air purification system. This unit is designed to be installed into an existing HVAC system and provide virtually maintenance free air purification. Please read and follow all service procedures outlined in this manual.

Please record the name and phone of your installing contractor.

Name _____

Phone _____

Please record the serial number of your Air Knight system.

Serial # _____

CONTENTS

Product Contents	3
Installation Hardware	3
Replacement Parts	3
Recommended Installation Tools	3
Specifications	4
About Air Knight.	4
Installation Requirements	5
Metal Ductwork Installation	6
Fiberglass Ductwork Installation	8
Maintenance/UV Lamp Indicator.	10
Disposal of Core	10
Changing Core	11
Warranty.	12





CONTENTS

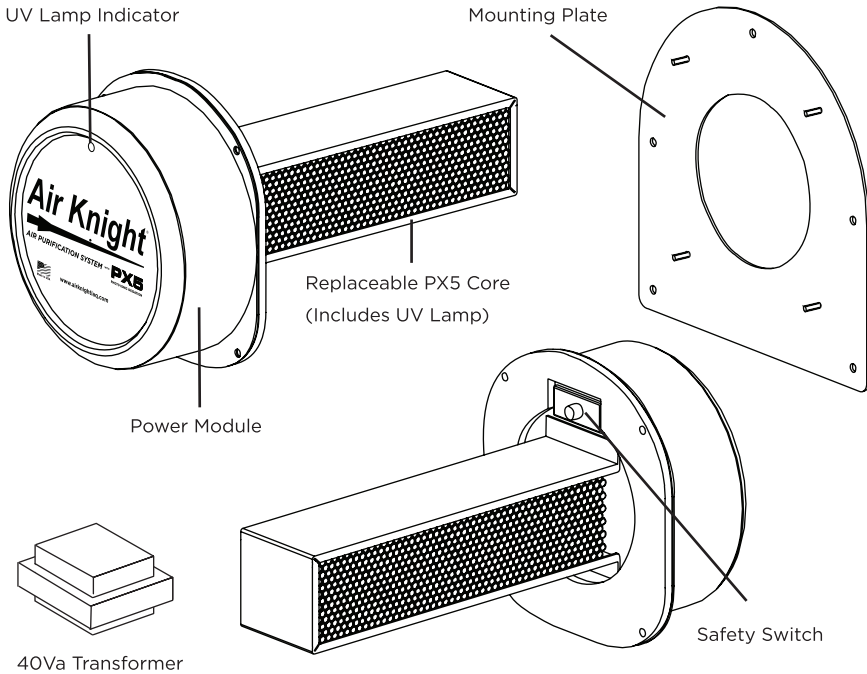

INSTALLATION HARDWARE

- | | |
|--|--|
| (5) 3/4" #8 Self Tapping Screws w/ 1/4" Hex Head | (2) 1/2" #10 Self Tapping Screws w/ 5/16" Hex Head |
| (5) 3" Threaded Bolts w/ Phillips Head | (4) 1/2" Brass Knurled Thumb Nuts #8-32 |
| (5) Butterfly Toggle Bolt Anchors | (4) #8 Star Lock Washers |
| (6) 18-22 Gauge Wire Screw-On Nuts | |

REPLACEMENT PARTS (Replace cell every 24 months.)

- Replacement 5" PX5 Core (Includes UV bulb) - #TT-AKCELL-5
- Replacement 9" PX5 Core (Includes UV bulb) - #TT-AKCELL-9

RECOMMENDED INSTALLATION TOOLS

- | | |
|---|--|
| <ul style="list-style-type: none"> • 3.5" Hole Saw (for metal) • Drill/Power Driver • Phillips Screwdriver • 3/8" Drill Bit (for fiberglass installation) | <p>You may also need:</p> <ul style="list-style-type: none"> • Utility Knife • Tin Snips (for metal ductwork) |
|---|--|





ABOUT AIR KNIGHT

The Air Knight In-Duct Active Air Purification System is a new generation HVAC air quality unit designed to reduce odors, smoke, germs, and a broad spectrum of indoor air contaminants.

The Air Knight system is easily mounted into HVAC system air ducts where many air quality problems can start. A unique technology, the Air Knight system uses UV light energy to illuminate a quint-metallic core to produce ionic oxidizers that seek out and attack indoor pollutants. These ionic “air scrubbers” clean the air AND surfaces where ever the air goes.

SPECIFICATIONS

Dimensions:

5" Model: 6"H x 6"W x 7"L

9" Model: 6"H x 6"W x 11"L

Mounting Plate: 7.875"H x 7.875"W

Electrical:

24V 50/60Hz.

Output:

13.3 Watts.

Weight:

Approx. 2.6lbs - 3lbs.

IMPORTANT:The device must be installed in compliance with all national and local electrical and mechanical codes. Failure to do so will void warranty.

Specifications subject to change without notice.



WARNING! UV Light in operation. Disconnect unit from power supply before servicing. Failure to follow warnings may result in severe eye damage.



To reduce the risk of electric shock, this equipment may have a grounding type plug that has a third (grounding) pin. This plug will only fit into a grounding type power outlet. If the plug does not fit into the outlet, contact qualified personnel to install the proper outlet. Do not alter the plug in any way.



Location for Protective Earth Line.





RECOMMENDED INSTALLATION TOOLS

1. Unit should be installed after the air handler or furnace in the HVAC system, prior to any branch duct takeoffs.
2. The ductwork around the installation area should be clean and dry to insure proper adhesion of the gasket materials and any tape used.
3. An approximate 3.5" opening will need to be cut into the existing ductwork to install unit properly.

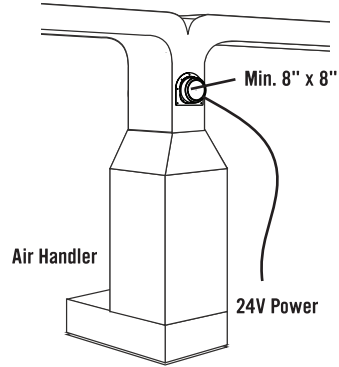

AIRFLOW ORIENTATION

Be sure to orient the unit for proper airflow through the PX5 core in either horizontal or vertical air flow systems. Air should be able to freely flow through PX5 core as shown.

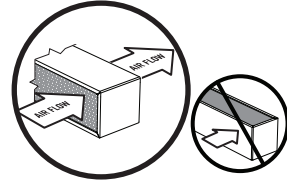

Remove air flow tag BEFORE installation.

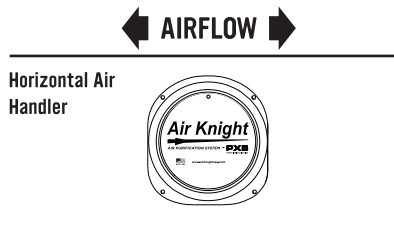

Be sure to install unit in proper orientation to air flow.

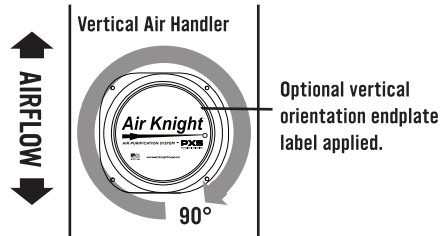

For vertical airflow installations, rotate unit 90° clockwise and apply provided vertical orientation endplate label.

HARDWARE REQUIREMENTS

Connect black and white wires to included dedicated 40Va transformer.



- Electrical wiring of the unit to the HVAC system should be done by a licensed HVAC installer or electrical contractor.





METAL DUCTWORK INSTALLATION

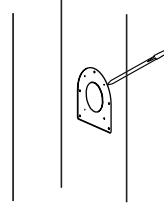
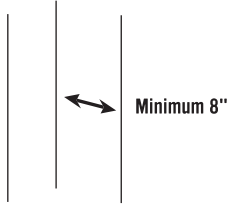

1. Determine suitable location in supply airstream main trunk before first branch take off. Proper power should be a consideration.

2. Mark location for 3.5" opening using the mounting plate.

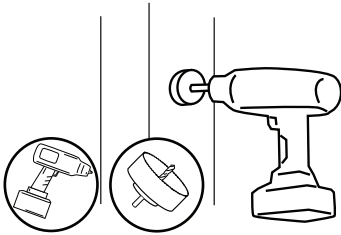

3. Cut hole in duct using 3.5" hole saw.

ALTERNATIVE METHOD

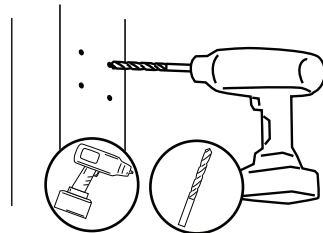
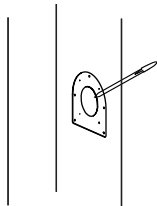

1. Use mounting plate to mark opening. Then mark 4 corner holes on duct.

2. Drill 4 holes where marked.

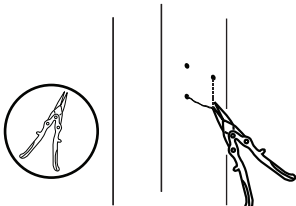

3. Cut between holes using tin snips.





METAL DUCTWORK INSTALLATION (continued)

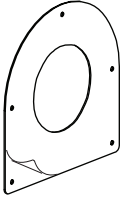

5. Remove backing from mounting plate adhesive gasket.

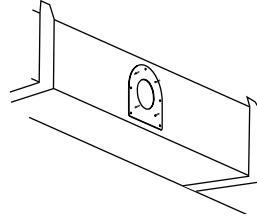

6. Center opening and press mounting plate onto duct. The adhesive gasket will hold the mounting plate in place.

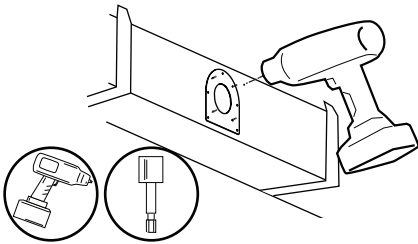

7. Secure the mounting plate using (5) self-tapping screws.

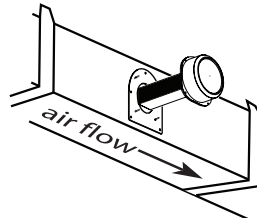

8. Insert unit into opening. Be sure air will pass through core as shown. See installation instructions on page 5.

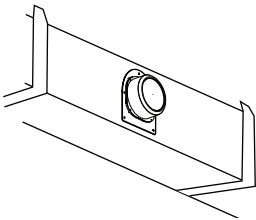

9. Secure the unit to the mounting plate with (4) knurled nuts.

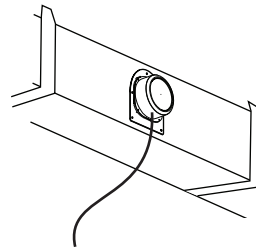

10. Connect to 24V power.



Hard wiring unit into HVAC system should be done by a licensed HVAC installer or electrical contractor.





FIBERGLASS DUCTWORK INSTALLATION

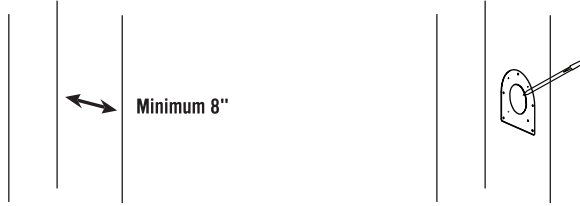

1. Locate suitable air duct for installation. Be sure to locate near proper power.

2. Mark location for 3.5" opening and screw holes using the mounting plate.

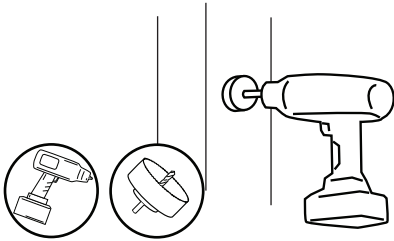

3. Mark location for 3.5" opening using the mounting plate.

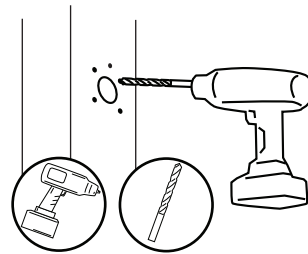

4. Drill the mounting holes using a 3/8" drill bit.

ALTERNATIVE METHOD



1. Use mounting plate to mark opening. Then mark 4 corner holes on duct.

2. Drill a line between each corner mark.

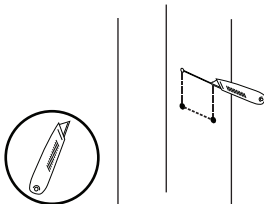

3. Cut between holes using a utility knife.





FIBERGLASS DUCTWORK INSTALLATION (continued)

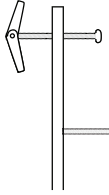
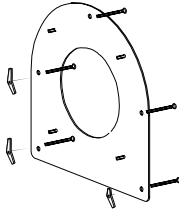

5. Insert 2" threaded bolts into screw holes in mounting plate. Attach toggle bolt anchors to ends of threaded bolts.

6. Remove backing from mounting plate adhesive gasket.

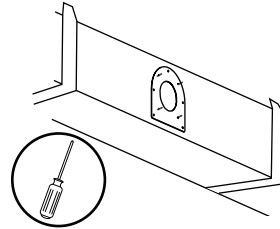
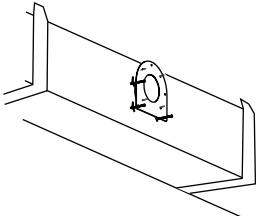

7. Insert toggle bolts into 3/8" holes in duct. Be sure toggle anchors open after inserting.

8. Center opening and press mounting plate onto duct. Tighten toggle bolts. **DO NOT OVERTIGHTEN.**

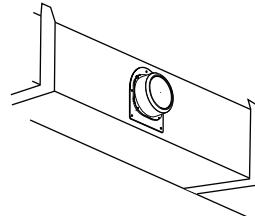
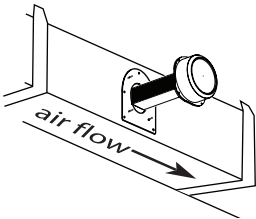

9. Insert unit into opening. Be sure air will pass through core as shown. See installation instructions on page 5.

10. Secure the unit to the mounting plate with (4) knurled nuts.

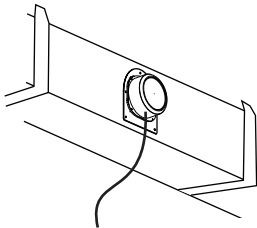

11. Connect to 24V power.



Hard wiring unit into HVAC system should be done by a licensed HVAC installer or electrical contractor.





MAINTENANCE/UV LAMP INDICATOR

For optimal performance, replace the PX5 core w/UV lamp (5" core - #TT-AKCELL-5, 9" core - #TT-AKCELL-9) every 2 years, even if the UV lamp appears to be operating normally.



The UV lamp operation indicator on the face of the unit will glow when the UV lamp is in use. If the indicator does not glow and the unit has power, the PX5 core should be replaced.

The ionization system should be inspected annually. Any buildup of dust should be wiped clean on the exterior and compressed air used to remove dust accumulated underneath the shroud and around the ionization system, if necessary.

DISPOSAL OF PX5 CORE AND UV LAMP

Dispose of spent PX5 core and UV lamp at your local recycling center. You may also send your spent PX5 core and UV lamp, in the same container you received your replacement, to:

Air Knight Reclamation:
1112 Industrial Drive
Royse City, TX 75189

Hg-LAMP CONTAINS MERCURY Manage in accord with disposal laws.
See: www.lamprecycle.org





CHANGING THE PX5 CORE (5" core - #TT-AKCELL-5, 9" core - #TT-AKCELL-9)



WARNING! UV Light in operation. Disconnect unit from power supply before servicing. Failure to follow warnings may result in severe eye damage.



1. Disconnect power to the unit.

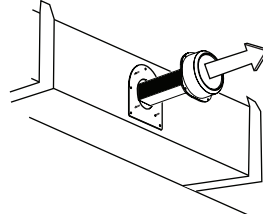

2. Remove the mounting nuts and remove the unit from the mounting plate.

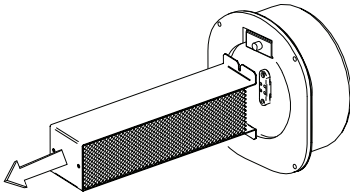

3. Remove the 2 screws holding the PX5 core and separate from the power module.

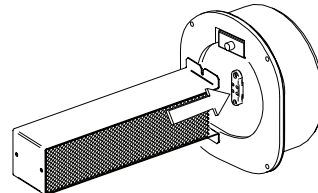

4. Install new PX5 core and secure to power module with 2 screws.

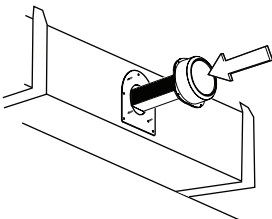

5. Insert unit into mounting plate and secure with nuts.

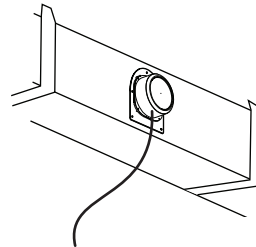

6. Reconnect power supply.





LIMITED WARRANTY

This warranty supersedes and replaces any warranty statements made orally by the Sales Person, Distributor, or Dealer, or contained within the written instructions or other brochures or informational documents related to this product.

Dust Free®, LP (Dust Free) warrants to the original purchaser that the Air Knight® Active Air Purifier (other than the PX5™ core and the UV Lamp) shall be free from defect in material and workmanship under normal use and service, for a period of five (5) years from the date of original purchase. Dust Free warrants to the original purchaser that the PX5 Core, Lamp and Catalyst Cell shall be free from defect in material and workmanship under normal use and service, for a period of two (2) years from the date of original purchase. Dust Free's obligation under this warranty shall be limited to the repair or replacement of those goods which prove defective, provided that such products are installed, maintained, and operated for the purpose and in the manner intended and for which Dust Free instructs or recommends. Neither Dust Free nor its dealers shall be liable for any special or consequential damages directly or indirectly arising from the design, construction, installation, servicing, or operation of the goods. SOME STATES DO NOT ALLOW THE EXCLUSION OR LIMITATION OF INCIDENTAL OR CONSEQUENTIAL DAMAGES, SO THE ABOVE EXCLUSION MAY NOT APPLY TO YOU. THIS IS DUST FREE'S SOLE WARRANTY AND THERE ARE NO WARRANTIES THAT EXTEND BEYOND THE DESCRIPTION ON THE FACE HEREOF. NEITHER DUST FREES NOR ITS DEALERS MAKE ANY OTHER WARRANTY OF ANY KIND, EXPRESS OR IMPLIED. ALL IMPLIED WARRANTIES OF MERCHANTABILITY AND FITNESS FOR A PARTICULAR PURPOSE WHICH EXCEED DUST FREES' AFFORESTATED OBLIGATIONS ARE HEREBY DISCLAIMED AND EXCLUDED FROM THIS WARRANTY. SOME STATES DO NOT ALLOW LIMITATIONS ON HOW LONG AN IMPLIED WARRANTY LASTS, SO THE ABOVE LIMITATION MAY NOT APPLY TO YOU. THIS WARRANTY GIVES YOU SPECIFIC LEGAL RIGHTS, AND YOU MAY ALSO HAVE OTHER RIGHTS WHICH VARY FROM STATE TO STATE. DUST FREE'S AND ITS DEALER'S LIABILITY UNDER THIS WARRANTY SHALL IN NO EVENT EXCEED THE COST OF THE GOODS SOLD UNDER THE CONTRACT OF SALE.

Dust Free neither assumes, nor authorizes any person to assume for it, any obligation in connection with the goods. This warranty shall not apply to any goods: (a) which have been subjected to misuse, tampering, negligence, or accidents; (b) the serial numbers of which have been altered, defaced, or removed; or (c) which have been used in a manner contrary to Dust Free's instructions or recommendations. This warranty may not be assigned or transferred. If any portion of this limited warranty is held illegal or unenforceable by reason of any law, such partial illegality or unenforceability shall not affect the enforceability of the remainder of this limited warranty.

For Warranty Claims:

By Telephone: Call Dust Free® at 1-972-635-2323, and ask to speak with a Customer Service Representative regarding a potential Warranty Claim. The Customer Service Representative will provide further instructions.

By Website: Visit Dust Free's website at www.dustfree.com and click on the "Contact" link to report a potential Warranty Claim. A Customer Service Representative will reply by email and can provide further instructions.

Dust Free®, LP, PO Box 519, Royse City, TX 75189. Please do not mail Warranty Claim requests or your product to this address. Warranty Claim requests are only accepted by telephone and through the website.

Include a copy of your Bill of Sale, Invoice or Receipt of Purchase, with an explanation of the problem or defect.

Rev. 2 07/13

